



CTC Laboratories, Inc.

1-2/F., Building 2, Jiaquan Building, Guanlan High-Tech Park, Shenzhen, Guangdong, China
Tel: +86-755- 27521059 Fax: +86-755- 27521011 Http://www.sz-ctc.org.cn

TEST REPORT

Report No.: **CTC20240101E14**

FCC ID.....: **2AYD5-I23M03**

Applicant.....: **Imin Technology Pte Ltd**

Address.....: 11 Bishan Street 21, #03-05 Bosch Building, Singapore, 573943

Manufacturer.....: Imin Technology Pte Ltd

Address.....: 11 Bishan Street 21, #03-05 Bosch Building, Singapore, 573943

Product Name.....: **POS Device**

Trade Mark.....: **imin**

Model/Type reference.....: I23M03

Listed Model(s): /



Standard.....: **FCC CFR Title 47 Part 15 Subpart C Section 15.247**

Date of receipt of test sample...: Jan. 18, 2024

Date of testing.....: Feb. 19, 2024 ~ Mar. 07, 2024

Date of issue.....: Mar. 08, 2024

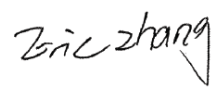
Result.....: **PASS**

| | | |
|--------------------------|------------|---|
| Compiled by: | | |
| (Printed name+signature) | Terry Su |  |
| Supervised by: | | |
| (Printed name+signature) | Eric Zhang |  |
| Approved by: | | |
| (Printed name+signature) | Totti Zhao |  |

Testing Laboratory Name.....: **CTC Laboratories, Inc.**

Address.....: 1-2/F., Building 2, Jiaquan Building, Guanlan High-Tech Park, Shenzhen, Guangdong, China

This test report may be duplicated completely for legal use with the approval of the applicant. It should not be reproduced except in full, without the written approval of our laboratory. The client should not use it to claim product endorsement by CTC. The test results in the report only apply to the tested sample. The test report shall be invalid without all the signatures of testing engineers, reviewer and approver. Any objections must be raised to CTC within 15 days since the date when the report is received. It will not be taken into consideration beyond this limit. The test report merely correspond to the test sample.



Table of Contents

Page

1. TEST SUMMARY..... 3

1.1. TEST STANDARDS 3

1.2. REPORT VERSION 3

1.3. TEST DESCRIPTION 4

1.4. TEST FACILITY 5

1.5. MEASUREMENT UNCERTAINTY 5

1.6. ENVIRONMENTAL CONDITIONS 6

2. GENERAL INFORMATION..... 7

2.1. CLIENT INFORMATION 7

2.2. GENERAL DESCRIPTION OF EUT 7

2.3. ACCESSORY EQUIPMENT INFORMATION..... 8

2.4. OPERATION STATE 9

2.5. MEASUREMENT INSTRUMENTS LIST 10

3. TEST ITEM AND RESULTS 12

3.1. CONDUCTED EMISSION 12

3.2. RADIATED EMISSION..... 17

3.3. BAND EDGE EMISSIONS (RADIATED)..... 27

3.4. BAND EDGE AND SPURIOUS EMISSIONS (CONDUCTED) 32

3.5. DTS BANDWIDTH 37

3.6. PEAK OUTPUT POWER..... 39

3.7. POWER SPECTRAL DENSITY..... 41

3.8. DUTY CYCLE..... 43

3.9. ANTENNA REQUIREMENT 45



1. TEST SUMMARY

1.1. Test Standards

The tests were performed according to following standards:

[FCC Rules Part 15.247](#): Operation within the bands of 902-928MHz, 2400-2483.5MHz, and 5725-5850MHz.

[RSS 247 Issue 3](#): Standard Specifications for Frequency Hopping Systems (FHSs) and Digital Transmission Systems (DTSS) Operating in the Bands 902-928MHz, 2400-2483.5MHz and 5725-5850MHz.

[ANSI C63.10-2013](#): American National Standard for Testing Unlicensed Wireless Devices.

[RSS-Gen Issue 5](#): General Requirements for Compliance of Radio Apparatus.

1.2. Report version

| Revised No. | Date of issue | Description |
|-------------|---------------|-------------|
| 01 | Mar. 08, 2024 | Original |
| | | |
| | | |
| | | |



1.3. Test Description

| FCC Part 15 Subpart C (15.247) / RSS 247 Issue 3 | | | | |
|--|-------------------------|-------------------------|--------|---------------|
| Test Item | Standard Section | | Result | Test Engineer |
| | FCC | IC | | |
| Antenna Requirement | 15.203 | / | Pass | Alicia Liu |
| Conducted Emission | 15.207 | RSS-Gen 8.8 | Pass | Cecilia Luo |
| Conducted Band Edge and Spurious Emissions | 15.247(d) | RSS 247 5.5 | Pass | Alicia Liu |
| Radiated Band Edge and Spurious Emissions | 15.205&15.209&15.247(d) | RSS 247 5.5 | Pass | Alicia Liu |
| 6dB Bandwidth | 15.247(a)(2) | RSS 247 5.2 (a) | Pass | Alicia Liu |
| Conducted Max Output Power | 15.247(b)(3) | RSS 247 5.4 (d) | Pass | Alicia Liu |
| Power Spectral Density | 15.247(e) | RSS 247 5.2 (b) | Pass | Alicia Liu |
| Transmitter Radiated Spurious | 15.209&15.247(d) | RSS 247 5.5&RSS-Gen 8.9 | Pass | Alicia Liu |

Note: "N/A" is not applicable.

The measurement uncertainty is not included in the test result.



1.4. Test Facility

CTC Laboratories, Inc.

Add: 1-2/F., Building 2, Jiaquan Building, Guanlan High-Tech Park, Shenzhen, Guangdong, China

Laboratory accreditation

The test facility is recognized, certified, or accredited by the following organizations:

A2LA-Lab Cert. No.: 4340.01

CTC Laboratories, Inc. EMC Laboratory has been accredited by A2LA for technical competence in the field of electrical testing, and proved to be in compliance with ISO/IEC 17025:2017 General Requirements for the Competence of Testing and Calibration Laboratories and any additional program requirements in the identified field of testing.

Industry Canada (Registration No.: 9783A, CAB Identifier: CN0029)

CTC Laboratories, Inc. EMC Laboratory has been registered by Certification and Engineer Bureau of Industry Canada for the performance of with Registration NO.: 9783A on Jan, 2016.

FCC (Registration No.: 951311, Designation Number CN1208)

CTC Laboratories, Inc. EMC Laboratory has been registered and fully described in a report filed with the (FCC) Federal Communications Commission. The acceptance letter from the FCC is maintained in our files. Registration 951311, Aug 26, 2017.

1.5. Measurement Uncertainty

The data and results referenced in this document are true and accurate. The reader is cautioned that there may be errors within the calibration limits of the equipment and facilities. The measurement uncertainty was calculated for all measurements listed in this test report acc. to TR-100028-01 "Electromagnetic compatibility and Radio spectrum Matters (ERM); Uncertainties in the measurement of mobile radio equipment characteristics; Part 1" and TR-100028-02 "Electromagnetic compatibility and Radio spectrum Matters (ERM); Uncertainties in the measurement of mobile radio equipment characteristics; Part 2" and is documented in the CTC Laboratories, Inc. quality system acc. to DIN EN ISO/IEC 17025. Furthermore, component and process variability of devices similar to that tested may result in additional deviation. The manufacturer has the sole responsibility of continued compliance of the device.

Below is the best measurement capability for CTC Laboratories, Inc.



| Test Items | Measurement Uncertainty | Notes |
|---|---|-------|
| DTS Bandwidth | $\pm 0.0196\%$ | (1) |
| Maximum Conducted Output Power | ± 0.686 dB | (1) |
| Maximum Power Spectral Density Level | ± 0.743 dB | (1) |
| Band-edge Compliance | ± 1.328 dB | (1) |
| Unwanted Emissions In Non-restricted Freq Bands | 9kHz-1GHz: ± 0.746 dB 1GHz-26GHz: ± 1.328 dB | (1) |
| Conducted Emissions 9kHz~30MHz | ± 3.08 dB | (1) |
| Radiated Emissions 30~1000MHz | ± 4.51 dB | (1) |
| Radiated Emissions 1~18GHz | ± 5.84 dB | (1) |
| Radiated Emissions 18~40GHz | ± 6.12 dB | (1) |

Note (1): This uncertainty represents an expanded uncertainty expressed at approximately the 95% confidence level using a coverage factor of k=2.

1.6. Environmental conditions

During the measurement the environmental conditions were within the listed ranges:

| | |
|--------------------|-------------|
| Temperature: | 21°C ~ 27°C |
| Relative Humidity: | 40% ~ 60% |
| Air Pressure: | 101kPa |



2. GENERAL INFORMATION

2.1. Client Information

| | |
|---------------|--|
| Applicant: | Imin Technology Pte Ltd |
| Address: | 11 Bishan Street 21, #03-05 Bosch Building, Singapore, 573943 |
| Manufacturer: | Imin Technology Pte Ltd |
| Address: | 11 Bishan Street 21, #03-05 Bosch Building, Singapore, 573943 |
| Factory 1: | Jiangxi Neostra Electronic Co. Ltd |
| Address: | 279 Shenzhen Road, Jingtangshan economic and Technological Development Zone, Ji'an, Jiangxi, China |
| Factory 2: | Neosta Technology Sdn. Bhd. |
| Address: | No. 78, Jln I-Park SAC 5, Taman Perindustrian i-Park SAC, 81400 Senai, Johor, Malaysia |

2.2. General Description of EUT

| | |
|-----------------------|--|
| Product Name: | POS Device |
| Trade Mark: |  |
| Model/Type reference: | I23M03 |
| Listed Model(s): | / |
| Power supply: | 5Vdc/2A from AC/DC Adapter 7.6Vdc from 2500mAh Li-ion Battery |
| Adapter 1 Model: | ADS-10LA-06 05010EPCU Input: 100-240V~ 50/60Hz 0.3A Max Output: 5Vdc/2A |
| Adapter 2 Model: | TPA-67050200UU Input: 100-240V~ 50/60Hz 0.3A Output: 5Vdc/2A |
| Hardware version: | / |
| Software version: | / |
| BT 5.0/ BLE | |
| Modulation: | GFSK |
| Data rate: | 1Mbps |
| Operation frequency: | 2402MHz~2480MHz |
| Channel number: | 40 |
| Channel separation: | 2MHz |
| Antenna type: | FPC Antenna |
| Antenna gain: | 1.9dBi Max |



2.3. Accessory Equipment information

| Equipment Information | | | |
|-----------------------|-------|-----|--------------|
| Name | Model | S/N | Manufacturer |
| / | / | / | / |

| Cable Information | | | |
|-------------------|---------------|--------------|--------|
| Name | Shielded Type | Ferrite Core | Length |
| / | / | / | / |

| Test Software Information | | | |
|---------------------------|----------|---|---|
| Name | Versions | / | / |
| Engineering mode | / | / | / |

2.4. Operation state

Operation Frequency List: The EUT has been tested under typical operating condition. The Applicant provides communication tools software to control the EUT for staying in continuous transmitting and receiving mode for testing. BT BLE, 40 channels are provided to the EUT. Channels 00/19/39 were selected for testing. Operation Frequency List:

| Channel | Frequency (MHz) |
|-----------|-----------------|
| 00 | 2402 |
| 01 | 2404 |
| : | : |
| 18 | 2438 |
| 19 | 2440 |
| 20 | 2442 |
| : | : |
| 38 | 2478 |
| 39 | 2480 |

Note: The display in grey were the channel selected for testing.

Test mode

| |
|--|
| For RF test items: |
| The engineering test program was provided and enabled to make EUT continuous transmit. |
| For AC power line conducted emissions: |
| The EUT was set to connect with the Bluetooth instrument under large package sizes transmission. |
| For Radiated spurious emissions test item: |
| The engineering test program was provided and enabled to make EUT continuous transmit. The EUT in each of three orthogonal axis emissions had been tested, but only the worst case (X axis) data recorded in the report. |



2.5. Measurement Instruments List

| RF Test System | | | | | |
|----------------|---------------------------------------|--------------|-----------|------------|------------------|
| Item | Test Equipment | Manufacturer | Model No. | Serial No. | Calibrated Until |
| 1 | Spectrum Analyzer | R&S | FSV40-N | 101331 | Mar. 14, 2024 |
| 2 | Spectrum Analyzer | R&S | FSV40-N | 101654 | Aug. 07, 2024 |
| 3 | Spectrum Analyzer | R&S | FSU26 | 100105 | Dec. 12, 2024 |
| 4 | MXA Signal Analyzer | Keysight | N9020A | MY46471737 | Dec. 12, 2024 |
| 5 | MXA Signal Analyzer | Keysight | N9020A | MY52091402 | Aug. 22, 2024 |
| 6 | MXG Vector Signal Generator | Agilent | N5182A | MY47420864 | Dec. 12, 2024 |
| 7 | PSG Analog Signal Generator | Agilent | E8257D | MY46521908 | Dec. 12, 2024 |
| 8 | EXG Analog Signal Generator | Keysight | N5173B | MY59100842 | Dec. 12, 2024 |
| 9 | MXG Vector Signal Generator | Keysight | N5182B | MY59100212 | Dec. 12, 2024 |
| 10 | Wideband Radio Communication Tester | R&S | CMW500 | 102257 | May. 25, 2024 |
| 11 | Wideband Radio Communication Tester | R&S | CMW500 | 102414 | Dec. 12, 2024 |
| 12 | High and low temperature test chamber | ESPEC | MT3035 | / | Mar. 24, 2024 |
| 13 | RF Control Unit | Tonscend | JS0806-2 | / | Aug. 22, 2024 |
| 14 | Test Software | Tonscend | JS1120-3 | V3.3.38 | / |

| Radiated Emission (3m chamber 2) | | | | | |
|----------------------------------|--------------------------|--------------|------------|------------|------------------|
| Item | Test Equipment | Manufacturer | Model No. | Serial No. | Calibrated Until |
| 1 | Trilog-Broadband Antenna | Schwarzbeck | VULB 9168 | 9168-1013 | Dec. 07, 2024 |
| 2 | Horn Antenna | Schwarzbeck | BBHA 9120D | 9120D-648 | Dec. 07, 2024 |
| 3 | Spectrum Analyzer | R&S | FSU26 | 100105 | Dec. 12, 2024 |
| 4 | Spectrum Analyzer | R&S | FSV40-N | 101331 | Mar. 14, 2024 |
| 5 | Pre-Amplifier | SONOMA | 310 | 186194 | Dec. 12, 2024 |
| 6 | Low Noise Pre-Amplifier | EMCI | EMC051835 | 980075 | Dec. 12, 2024 |
| 7 | Test Receiver | R&S | ESCI7 | 100967 | Dec. 12, 2024 |
| 8 | 3m chamber 2 | Frankonia | EE025 | / | Oct. 23, 2024 |
| 9 | Test Software | FARA | EZ-EMC | FA-03A2 | / |

| Radiated Emission (3m chamber 3) | | | | | |
|----------------------------------|------------------------------|--------------|------------|------------|------------------|
| Item | Test Equipment | Manufacturer | Model No. | Serial No. | Calibrated Until |
| 1 | Trilog-Broadband Antenna | Schwarzbeck | VULB 9163 | 01026 | Dec. 18, 2024 |
| 2 | Horn Antenna | Schwarzbeck | BBHA 9120D | 9120D-647 | Dec. 01, 2024 |
| 3 | Test Receiver | Keysight | N9038A | MY56400071 | Dec. 12, 2024 |
| 4 | Broadband Amplifier | SCHWARZBECK | BBV9743B | 259 | Dec. 12, 2024 |
| 5 | Mirowave Broadband Amplifier | SCHWARZBECK | BBV9718C | 111 | Dec. 12, 2024 |

CTC Laboratories, Inc.

1-2/F., Building 2, Jiaquan Building, Guanlan High-Tech Park, Shenzhen, Guangdong, China

Tel.: (86)755-27521059

Fax: (86)755-27521011

Http://www.sz-ctc.org.cn



For anti-fake verification, please visit the official website of Certification and Accreditation Administration of the People's Republic of China : [yz.cnca.cn](http://www.cnca.cn)



| | | | | | |
|---|---------------|--------|--------|---------|---------------|
| 6 | 3m chamber 3 | YIHENG | EE106 | / | Aug. 28, 2026 |
| 7 | Test Software | FARA | EZ-EMC | FA-03A2 | / |

| Conducted Emission | | | | | |
|--------------------|-------------------|--------------|-----------|----------------|------------------|
| Item | Test Equipment | Manufacturer | Model No. | Serial No. | Calibrated Until |
| 1 | LISN | R&S | ENV216 | 101112 | Dec. 12, 2024 |
| 2 | LISN | R&S | ENV216 | 101113 | Dec. 12, 2024 |
| 3 | EMI Test Receiver | R&S | ESCS30 | 100353 | Dec. 12, 2024 |
| 4 | ISN CAT6 | Schwarzbeck | NTFM 8158 | CAT6-8158-0046 | Dec. 12, 2024 |
| 5 | ISN CAT5 | Schwarzbeck | NTFM 8158 | CAT5-8158-0046 | Dec. 12, 2024 |
| 6 | Test Software | R&S | EMC32 | 6.10.10 | / |

- Note: 1. The Cal. Interval was one year.
 2. The Cal. Interval was three year of the chamber
 3. The cable loss has calculated in test result which connection between each test instruments.

3. TEST ITEM AND RESULTS

3.1. Conducted Emission

Limit

FCC CFR Title 47 Part 15 Subpart C Section 15.207/ RSS - Gen 8.8

| Frequency range (MHz) | Limit (dBuV) | |
|-----------------------|--------------|-----------|
| | Quasi-peak | Average |
| 0.15-0.5 | 66 to 56* | 56 to 46* |
| 0.5-5 | 56 | 46 |
| 5-30 | 60 | 50 |

* Decreases with the logarithm of the frequency.

Test Configuration

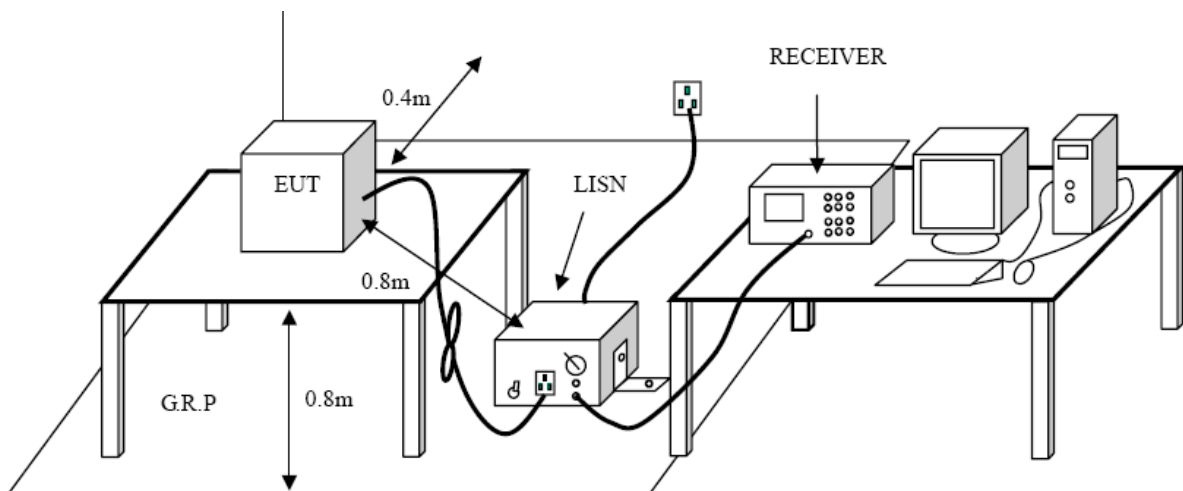

Test Procedure

1. The EUT was setup according to ANSI C63.10:2013 requirements.
2. The EUT was placed on a platform of nominal size, 1 m by 1.5 m, Raised 80 cm above the conducting ground plane. The vertical conducting plane was located 40 cm to the rear of the EUT. All other surfaces of EUT were at least 80 cm from any other grounded conducting surface.
3. The EUT and simulators are connected to the main power through a line impedances stabilization network (LISN). The LISN provides a 50ohm /50uH coupling impedance for the measuring equipment. The peripheral devices are also connected to the main power through a LISN. (Please refer to the block diagram of the test setup and photographs)
4. Each current-carrying conductor of the EUT power cord, except the ground (safety) conductor, was individually connected through a LISN to the input power source.
5. The excess length of the power cord between the EUT and the LISN receptacle were folded back and forth at the center of the lead to form a bundle not exceeding 40 cm in length.
6. Conducted Emissions were investigated over the frequency range from 0.15MHz to 30MHz using a receiver bandwidth of 9 kHz.
7. During the above scans, the emissions were maximized by cable manipulation.



Test Mode:

Please refer to the clause 2.4.

Test Results

| | |
|-----------------------|-----------------------|
| Test Voltage: | AC 120V/60 Hz |
| Terminal: | Line |
| Adapter Model: | ADS-10LA-06 05010EPCU |

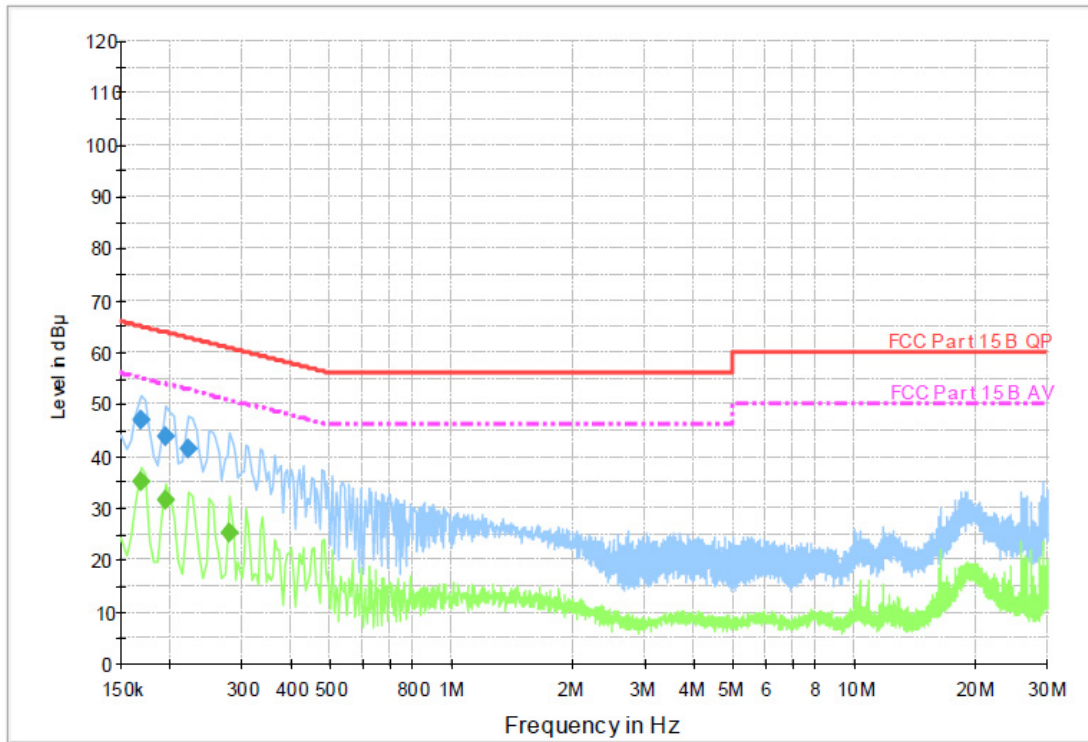

Final Measurement Detector 1

| Frequency (MHz) | QuasiPeak (dBµ V) | Meas. Time (ms) | Bandwidth (kHz) | Filter | Line | Corr. (dB) | Margin (dB) | Limit (dBµ V) | Comment |
|-----------------|-------------------|-----------------|-----------------|--------|------|------------|-------------|---------------|---------|
| 0.168000 | 47.0 | 1000.00 | 9.000 | On | L1 | 9.3 | 18.1 | 65.1 | |
| 0.195000 | 43.9 | 1000.00 | 9.000 | On | L1 | 9.3 | 19.9 | 63.8 | |
| 0.222000 | 41.3 | 1000.00 | 9.000 | On | L1 | 9.3 | 21.4 | 62.7 | |

Final Measurement Detector 2

| Frequency (MHz) | Average (dBµ V) | Meas. Time (ms) | Bandwidth (kHz) | Filter | Line | Corr. (dB) | Margin (dB) | Limit (dBµ V) | Comment |
|-----------------|-----------------|-----------------|-----------------|--------|------|------------|-------------|---------------|---------|
| 0.168000 | 35.2 | 1000.00 | 9.000 | On | L1 | 9.3 | 19.9 | 55.1 | |
| 0.195000 | 31.5 | 1000.00 | 9.000 | On | L1 | 9.3 | 22.3 | 53.8 | |
| 0.280500 | 25.1 | 1000.00 | 9.000 | On | L1 | 9.3 | 25.7 | 50.8 | |

Emission Level= Read Level+ Correct Factor



| | |
|-----------------------|-----------------------|
| Test Voltage: | AC 120V/60 Hz |
| Terminal: | Neutral |
| Adapter Model: | ADS-10LA-06 05010EPCU |

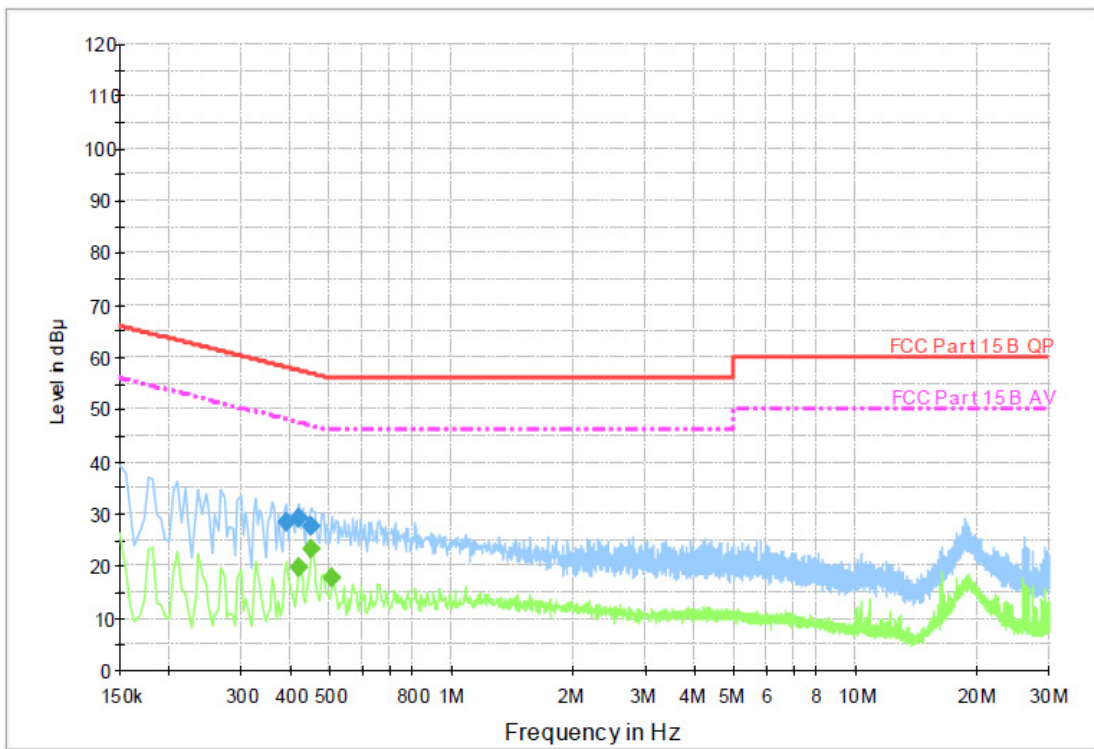

Final Measurement Detector 1

| Frequency (MHz) | QuasiPeak (dBµ V) | Meas. Time (ms) | Bandwidth (kHz) | Filter | Line | Corr. (dB) | Margin (dB) | Limit (dBµ V) | Comment |
|-----------------|-------------------|-----------------|-----------------|--------|------|------------|-------------|---------------|---------|
| 0.388500 | 28.3 | 1000.00 | 9.000 | On | N | 9.4 | 29.8 | 58.1 | |
| 0.415500 | 29.0 | 1000.00 | 9.000 | On | N | 9.4 | 28.5 | 57.5 | |
| 0.447000 | 27.8 | 1000.00 | 9.000 | On | N | 9.4 | 29.1 | 56.9 | |

Final Measurement Detector 2

| Frequency (MHz) | Average (dBµ V) | Meas. Time (ms) | Bandwidth (kHz) | Filter | Line | Corr. (dB) | Margin (dB) | Limit (dBµ V) | Comment |
|-----------------|-----------------|-----------------|-----------------|--------|------|------------|-------------|---------------|---------|
| 0.415500 | 19.7 | 1000.00 | 9.000 | On | N | 9.4 | 27.8 | 47.5 | |
| 0.447000 | 23.1 | 1000.00 | 9.000 | On | N | 9.4 | 23.8 | 46.9 | |
| 0.505500 | 17.9 | 1000.00 | 9.000 | On | N | 9.4 | 28.1 | 46.0 | |

Emission Level= Read Level+ Correct Factor



| | |
|-----------------------|----------------|
| Test Voltage: | AC 120V/60 Hz |
| Terminal: | Line |
| Adapter Model: | TPA-67050200UU |

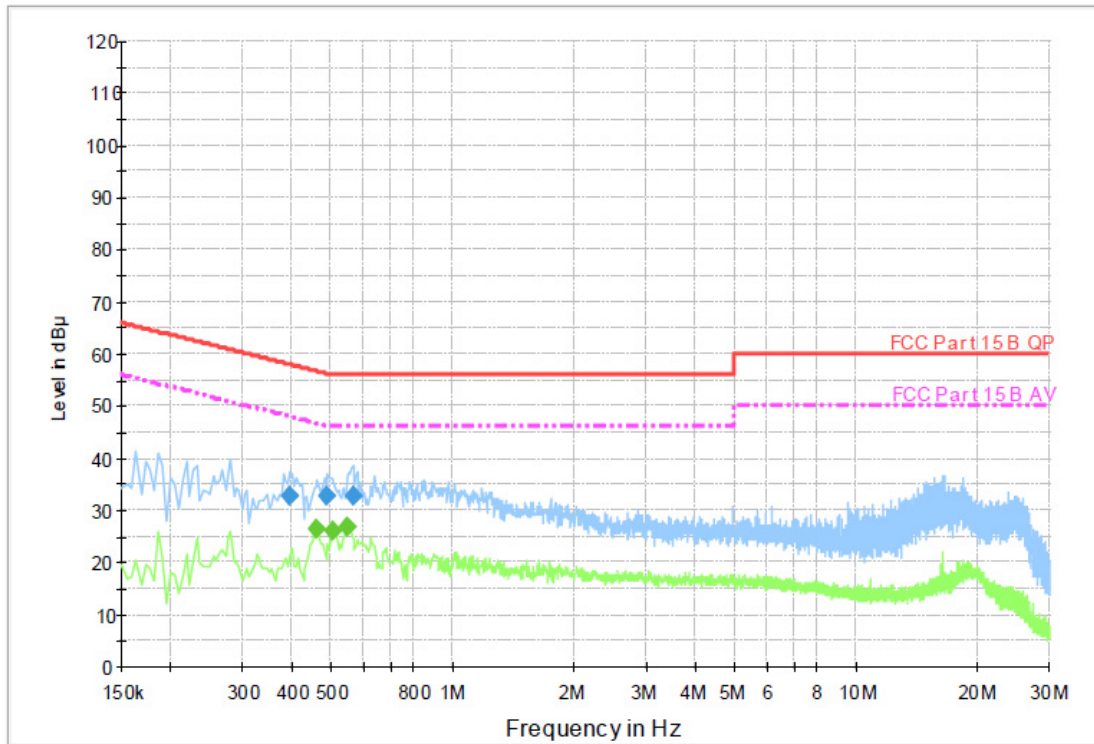

Final Measurement Detector 1

| Frequency (MHz) | QuasiPeak (dBμ V) | Meas. Time (ms) | Bandwidth (kHz) | Filter | Line | Corr. (dB) | Margin (dB) | Limit (dBμ V) | Comment |
|-----------------|-------------------|-----------------|-----------------|--------|------|------------|-------------|---------------|---------|
| 0.393000 | 32.6 | 1000.00 | 9.000 | On | L1 | 9.5 | 25.4 | 58.0 | |
| 0.487500 | 32.8 | 1000.00 | 9.000 | On | L1 | 9.5 | 23.4 | 56.2 | |
| 0.564000 | 32.7 | 1000.00 | 9.000 | On | L1 | 9.5 | 23.3 | 56.0 | |

Final Measurement Detector 2

| Frequency (MHz) | Average (dBμ V) | Meas. Time (ms) | Bandwidth (kHz) | Filter | Line | Corr. (dB) | Margin (dB) | Limit (dBμ V) | Comment |
|-----------------|-----------------|-----------------|-----------------|--------|------|------------|-------------|---------------|---------|
| 0.456000 | 26.3 | 1000.00 | 9.000 | On | L1 | 9.5 | 20.5 | 46.8 | |
| 0.501000 | 26.2 | 1000.00 | 9.000 | On | L1 | 9.5 | 19.8 | 46.0 | |
| 0.546000 | 27.0 | 1000.00 | 9.000 | On | L1 | 9.5 | 19.0 | 46.0 | |

Emission Level= Read Level+ Correct Factor



| | |
|-----------------------|----------------|
| Test Voltage: | AC 120V/60 Hz |
| Terminal: | Neutral |
| Adapter Model: | TPA-67050200UU |

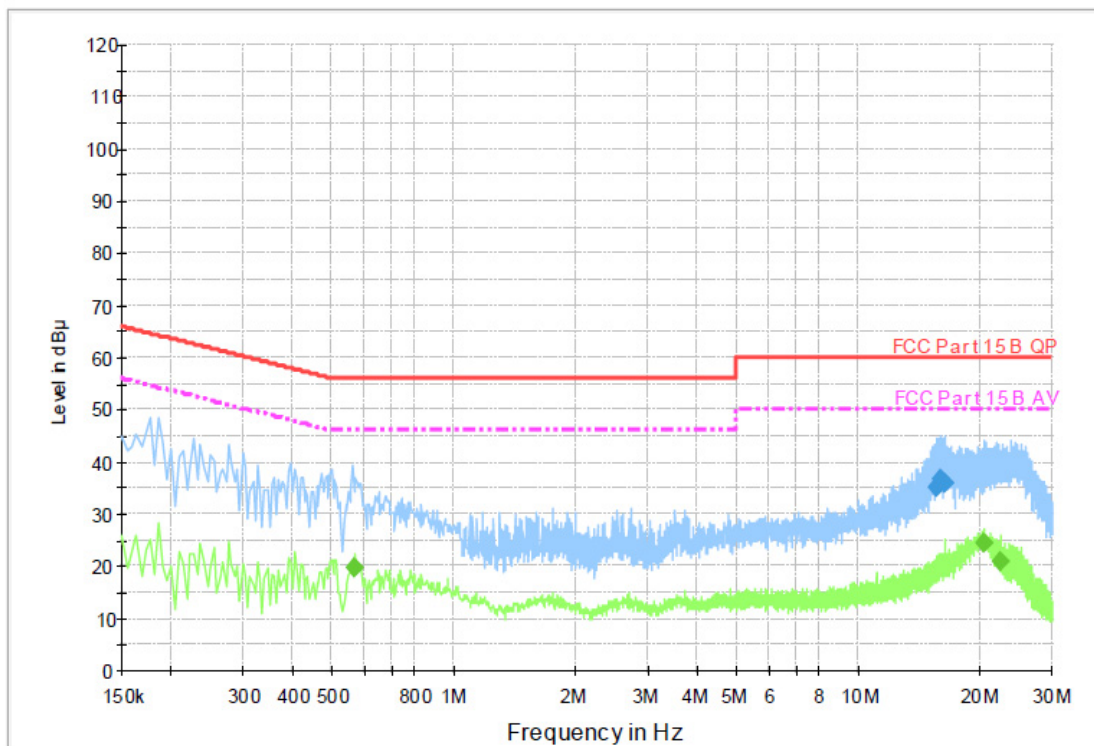

Final Measurement Detector 1

| Frequency (MHz) | QuasiPeak (dBμ V) | Meas. Time (ms) | Bandwidth (kHz) | Filter | Line | Corr. (dB) | Margin (dB) | Limit (dBμ V) | Comment |
|-----------------|-------------------|-----------------|-----------------|--------|------|------------|-------------|---------------|---------|
| 15.598500 | 35.3 | 1000.00 | 9.000 | On | N | 9.5 | 24.7 | 60.0 | |
| 15.823500 | 36.5 | 1000.00 | 9.000 | On | N | 9.5 | 23.5 | 60.0 | |
| 16.242000 | 36.0 | 1000.00 | 9.000 | On | N | 9.5 | 24.0 | 60.0 | |

Final Measurement Detector 2

| Frequency (MHz) | Average (dBμ V) | Meas. Time (ms) | Bandwidth (kHz) | Filter | Line | Corr. (dB) | Margin (dB) | Limit (dBμ V) | Comment |
|-----------------|-----------------|-----------------|-----------------|--------|------|------------|-------------|---------------|---------|
| 0.568500 | 19.5 | 1000.00 | 9.000 | On | N | 9.4 | 26.5 | 46.0 | |
| 20.251500 | 24.6 | 1000.00 | 9.000 | On | N | 9.5 | 25.4 | 50.0 | |
| 22.339500 | 21.1 | 1000.00 | 9.000 | On | N | 9.5 | 28.9 | 50.0 | |

Emission Level= Read Level+ Correct Factor

3.2. Radiated Emission

Limit

FCC CFR Title 47 Part 15 Subpart C Section 15.209/ RSS – Gen 8.9

| Frequency | Limit (dBuV/m @3m) | Value |
|-------------------|--------------------|------------|
| 30 MHz ~ 88 MHz | 40.00 | Quasi-peak |
| 88 MHz ~ 216 MHz | 43.50 | Quasi-peak |
| 216 MHz ~ 960 MHz | 46.00 | Quasi-peak |
| 960 MHz ~ 1 GHz | 54.00 | Quasi-peak |
| Above 1 GHz | 54.00 | Average |
| | 74.00 | Peak |

Note:

- (1) The tighter limit applies at the band edges.
- (2) Emission Level (dBuV/m)=20log Emission Level (uV/m).

Test Configuration

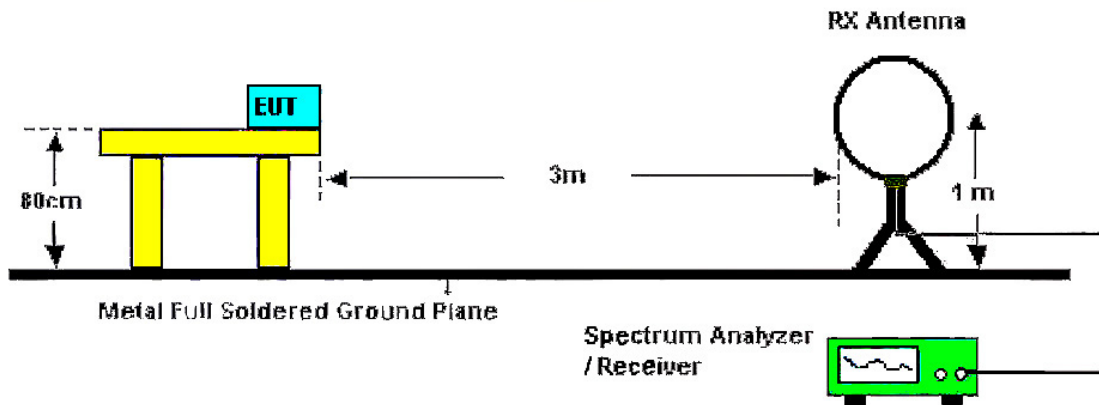

Below 30MHz Test Setup

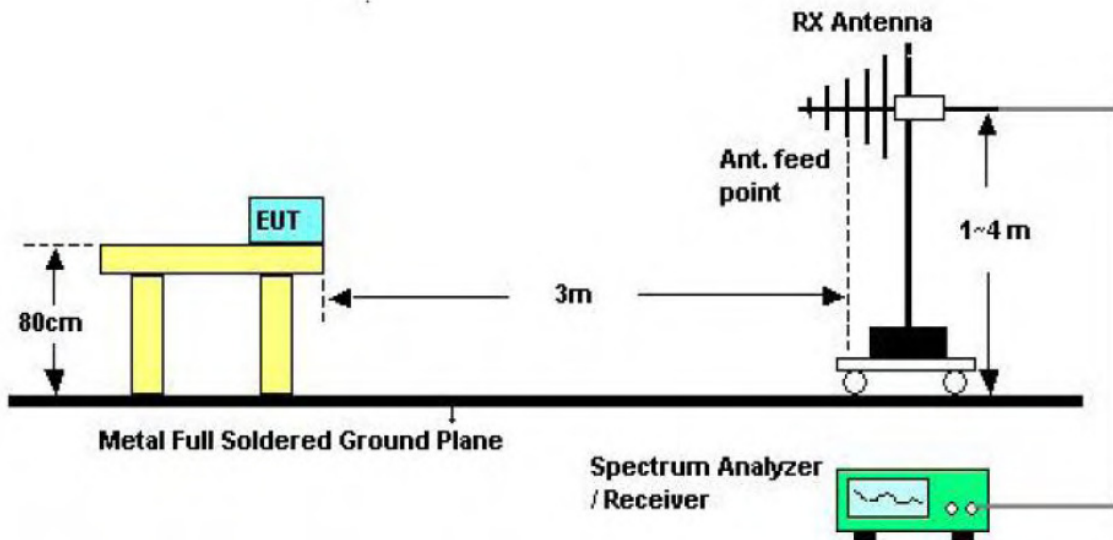

Below 1000MHz Test Setup

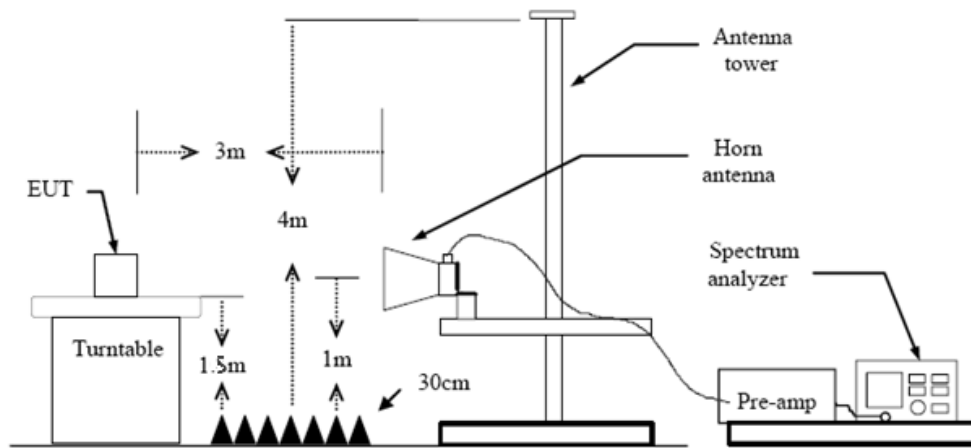

Above 1GHz Test Setup

Test Procedure

1. The EUT was setup and tested according to ANSI C63.10:2013
 2. The EUT is placed on a turn table which is 0.8 meter above ground for below 1 GHz, and 1.5 m for above 1 GHz. The turn table is rotated 360 degrees to determine the position of the maximum emission level.
 3. The EUT was set 3 meters from the receiving antenna, which was mounted on the top of a variable height antenna tower.
 4. For each suspected emission, the EUT was arranged to its worst case and then tune the Antenna tower (from 1 m to 4 m) and turntable (from 0 degree to 360 degrees) to find the maximum reading. A pre-amp and a high pass filter are used for the test in order to get better signal level to comply with the guidelines.
 5. Set to the maximum power setting and enable the EUT transmit continuously.
 6. Use the following spectrum analyzer settings
 - (1) Span shall wide enough to fully capture the emission being measured;
 - (2) Below 30 MHz:
9kHz – 150kHz, RBW=200Hz, VBW \geq RBW, Sweep=auto, Detector function=peak, Trace=max hold;
150kHz – 30MHz, RBW=9kHz, VBW \geq RBW, Sweep=auto, Detector function=peak, Trace=max hold; If the emission level of the EUT measured by the peak detector is 3 dB lower than the applicable limit, the peak emission level will be reported. Otherwise, the emission measurement will be repeated using the quasi-peak detector and reported.
 - (3) 30 MHz - 1 GHz:
RBW=120 kHz, VBW=300 kHz, Sweep=auto, Detector function=peak, Trace=max hold;
If the emission level of the EUT measured by the peak detector is 3 dB lower than the applicable limit, the peak emission level will be reported. Otherwise, the emission measurement will be repeated using the quasi-peak detector and reported.
 - (3) From 1 GHz to 10th harmonic:
RBW=1MHz, VBW=3MHz Peak detector for Peak value.
RBW=1MHz, VBW \geq 1/T Peak detector for Average value.
- Note 1: For the 1/T& Duty Cycle please refer to clause 3.8 Duty Cycle.

Test Mode

Please refer to the clause 2.4.

Test Result

9 KHz~30 MHz

From 9 KHz to 30 MHz: Conclusion: PASS

Note: The amplitude of spurious emissions which are attenuated by more than 20dB below the permissible value has no need to be reported.



30MHz-1GHz

| | |
|------------|-----------------------------|
| Ant. Pol. | Horizontal |
| Test Mode: | TX Mode 2402MHz |
| Remark: | Only worse case is reported |

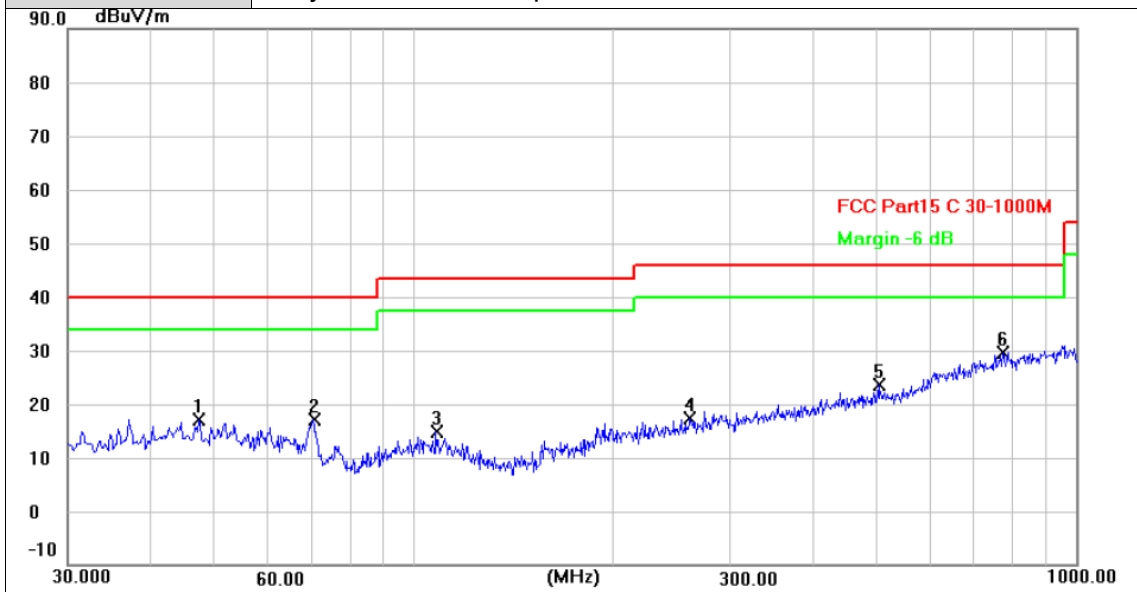

| No. | Frequency (MHz) | Reading (dBuV) | Factor (dB/m) | Level (dBuV/m) | Limit (dBuV/m) | Margin (dB) | Detector |
|-----|-----------------|----------------|---------------|----------------|----------------|-------------|----------|
| 1 | 47.4600 | 32.72 | -15.71 | 17.01 | 40.00 | -22.99 | QP |
| 2 | 70.4167 | 37.03 | -19.98 | 17.05 | 40.00 | -22.95 | QP |
| 3 | 108.2467 | 32.49 | -17.71 | 14.78 | 43.50 | -28.72 | QP |
| 4 | 261.8299 | 33.38 | -15.94 | 17.44 | 46.00 | -28.56 | QP |
| 5 | 503.6833 | 33.93 | -10.42 | 23.51 | 46.00 | -22.49 | QP |
| 6 * | 774.9600 | 35.29 | -5.68 | 29.61 | 46.00 | -16.39 | QP |

Remarks:

- Factor (dB/m) = Antenna Factor (dB/m)+Cable Factor (dB)-Pre-amplifier Factor
- Margin value = Level -Limit value



| | |
|-------------------|-----------------------------|
| Ant. Pol. | Vertical |
| Test Mode: | TX Mode 2402MHz |
| Remark: | Only worse case is reported |

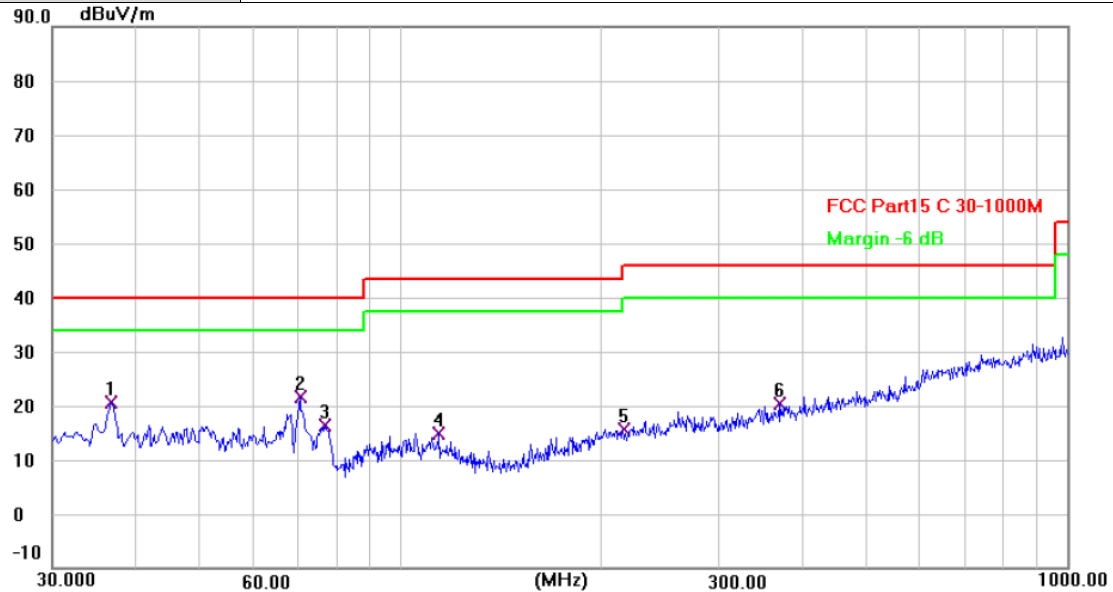

| No. | Frequency (MHz) | Reading (dBuV) | Factor (dB/m) | Level (dBuV/m) | Limit (dBuV/m) | Margin (dB) | Detector |
|-----|-----------------|----------------|---------------|----------------|----------------|-------------|----------|
| 1 | 36.7900 | 38.00 | -17.31 | 20.69 | 40.00 | -19.31 | QP |
| 2 * | 70.7400 | 41.64 | -20.10 | 21.54 | 40.00 | -18.46 | QP |
| 3 | 76.8833 | 38.10 | -21.72 | 16.38 | 40.00 | -23.62 | QP |
| 4 | 114.3900 | 33.35 | -18.41 | 14.94 | 43.50 | -28.56 | QP |
| 5 | 215.9167 | 32.99 | -17.27 | 15.72 | 43.50 | -27.78 | QP |
| 6 | 369.5000 | 33.49 | -13.04 | 20.45 | 46.00 | -25.55 | QP |

Remarks:

1. Factor (dB/m) = Antenna Factor (dB/m)+Cable Factor (dB)-Pre-amplifier Factor
2. Margin value = Level -Limit value



Above 1GHz

| | |
|-------------------|--|
| Ant. Pol. | Horizontal |
| Test Mode: | TX BLE Mode 2402MHz |
| Remark: | No report for the emission which more than 10 dB below the prescribed limit. |

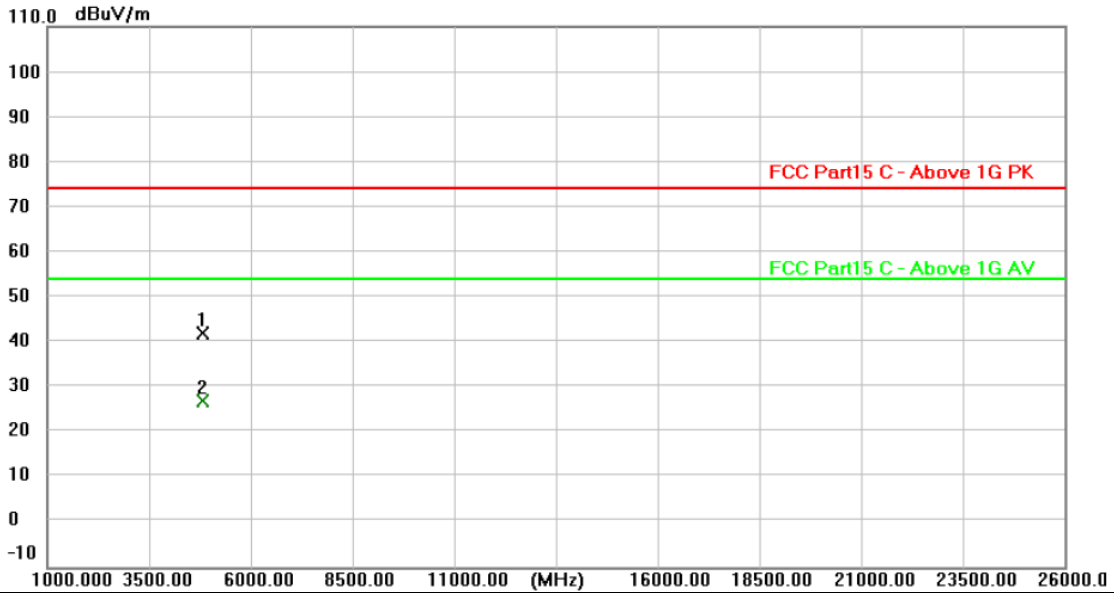

| No. | Frequency (MHz) | Reading (dBuV) | Factor (dB/m) | Level (dBuV/m) | Limit (dBuV/m) | Margin (dB) | Detector |
|-----|-----------------|----------------|---------------|----------------|----------------|-------------|----------|
| 1 | 4804.045 | 40.17 | 2.00 | 42.17 | 74.00 | -31.83 | peak |
| 2 * | 4804.470 | 25.09 | 2.00 | 27.09 | 54.00 | -26.91 | AVG |

Remarks:
 1. Factor (dB/m) = Antenna Factor (dB/m)+Cable Factor (dB)-Pre-amplifier Factor
 2. Margin value = Level -Limit value



| | |
|-------------------|--|
| Ant. Pol. | Vertical |
| Test Mode: | TX BLE Mode 2402MHz |
| Remark: | No report for the emission which more than 10 dB below the prescribed limit. |

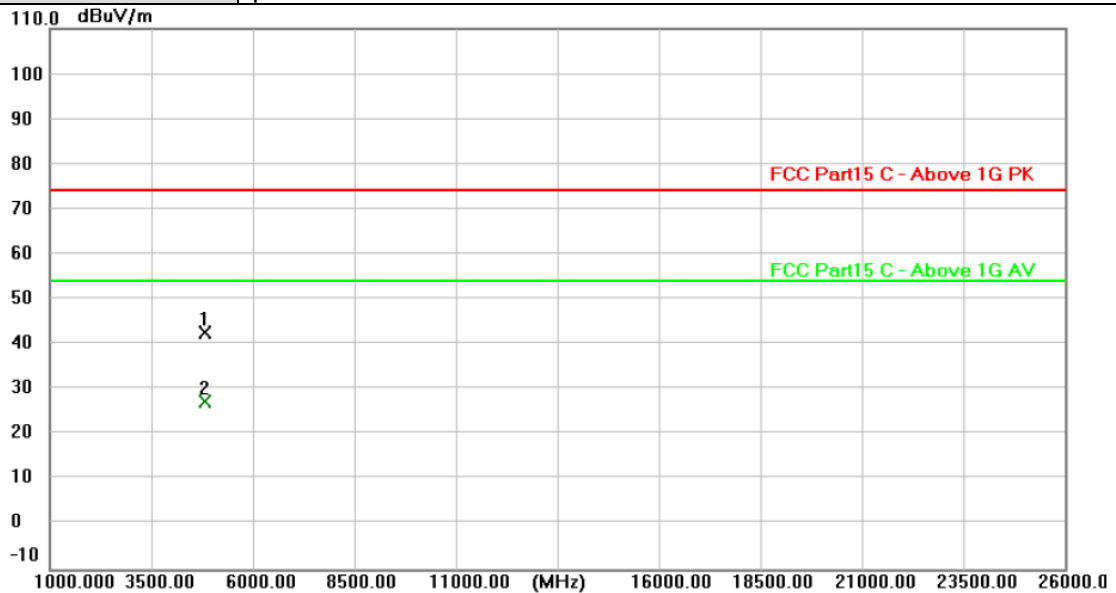

| No. | Frequency (MHz) | Reading (dBuV) | Factor (dB/m) | Level (dBuV/m) | Limit (dBuV/m) | Margin (dB) | Detector |
|-----|-----------------|----------------|---------------|----------------|----------------|-------------|----------|
| 1 | 4803.868 | 40.53 | 2.00 | 42.53 | 74.00 | -31.47 | peak |
| 2 * | 4804.077 | 25.21 | 2.00 | 27.21 | 54.00 | -26.79 | AVG |

Remarks:
 1. Factor (dB/m) = Antenna Factor (dB/m)+Cable Factor (dB)-Pre-amplifier Factor
 2. Margin value = Level -Limit value



| | |
|-------------------|--|
| Ant. Pol. | Horizontal |
| Test Mode: | TX BLE Mode 2440MHz |
| Remark: | No report for the emission which more than 10 dB below the prescribed limit. |

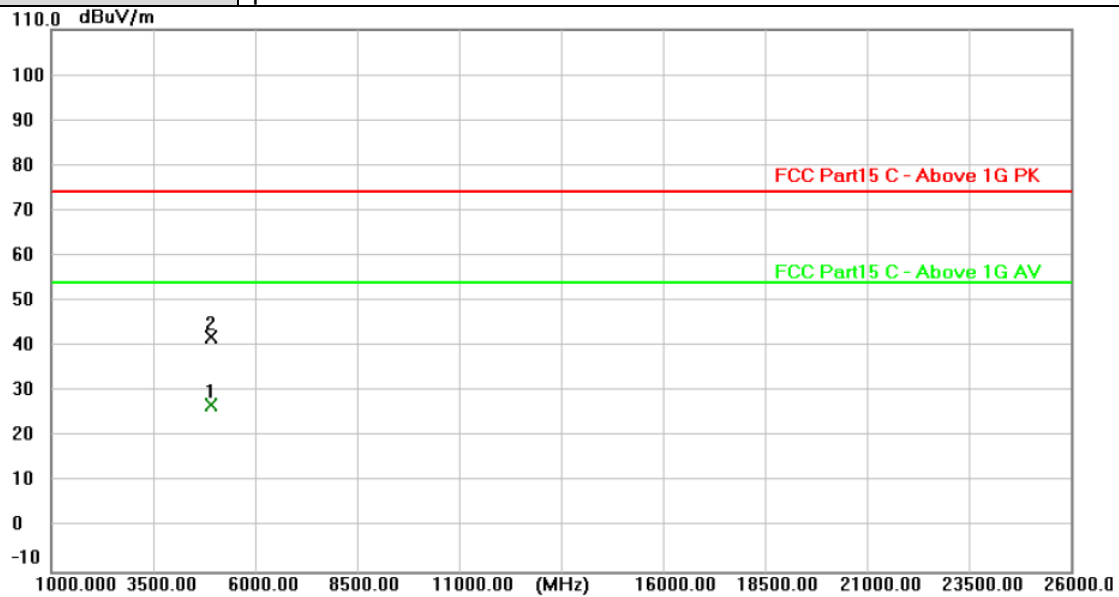

| No. | Frequency (MHz) | Reading (dBuV) | Factor (dB/m) | Level (dBuV/m) | Limit (dBuV/m) | Margin (dB) | Detector |
|-----|-----------------|----------------|---------------|----------------|----------------|-------------|----------|
| 1 * | 4879.826 | 24.89 | 2.09 | 26.98 | 54.00 | -27.02 | AVG |
| 2 | 4880.201 | 40.05 | 2.09 | 42.14 | 74.00 | -31.86 | peak |

Remarks:
 1. Factor (dB/m) = Antenna Factor (dB/m) + Cable Factor (dB) - Pre-amplifier Factor
 2. Margin value = Level - Limit value



| | |
|-------------------|--|
| Ant. Pol. | Vertical |
| Test Mode: | TX BLE Mode 2440MHz |
| Remark: | No report for the emission which more than 10 dB below the prescribed limit. |

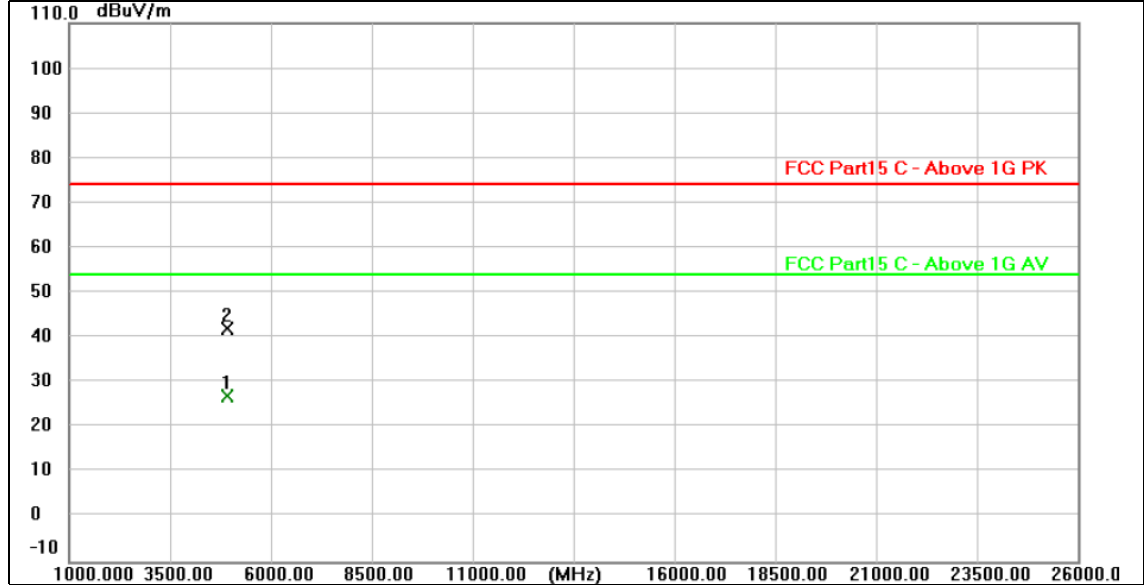

| No. | Frequency (MHz) | Reading (dBUV) | Factor (dB/m) | Level (dBUV/m) | Limit (dBUV/m) | Margin (dB) | Detector |
|-----|-----------------|----------------|---------------|----------------|----------------|-------------|----------|
| 1 * | 4879.634 | 24.94 | 2.09 | 27.03 | 54.00 | -26.97 | AVG |
| 2 | 4880.445 | 40.07 | 2.09 | 42.16 | 74.00 | -31.84 | peak |

Remarks:
 1. Factor (dB/m) = Antenna Factor (dB/m)+Cable Factor (dB)-Pre-amplifier Factor
 2. Margin value = Level -Limit value



| | |
|-------------------|--|
| Ant. Pol. | Horizontal |
| Test Mode: | TX BLE Mode 2480MHz |
| Remark: | No report for the emission which more than 10 dB below the prescribed limit. |

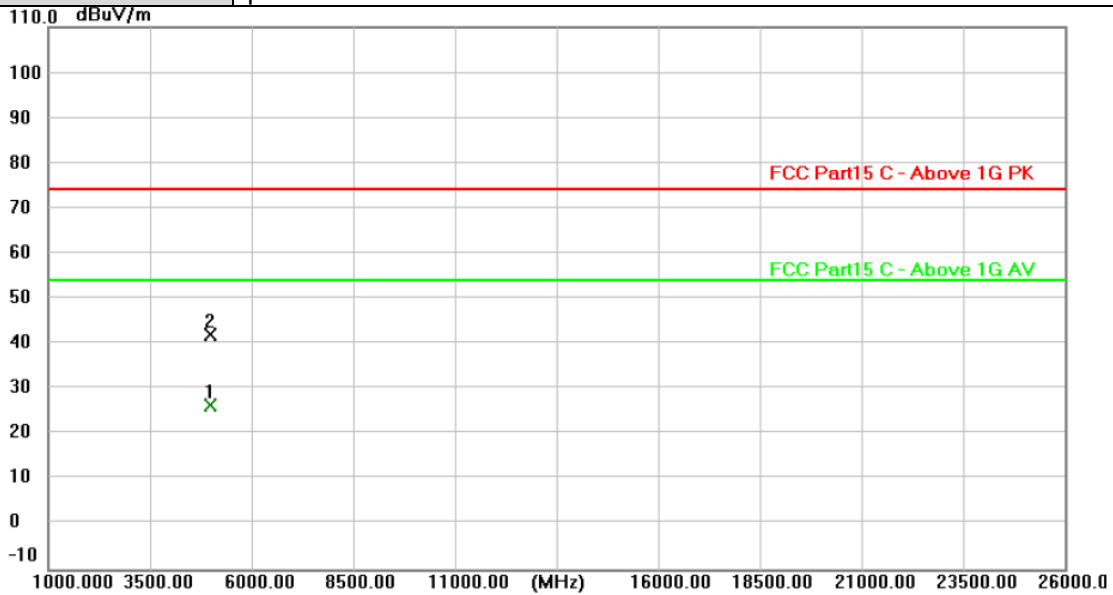

| No. | Frequency (MHz) | Reading (dBuV) | Factor (dB/m) | Level (dBuV/m) | Limit (dBuV/m) | Margin (dB) | Detector |
|-----|-----------------|----------------|---------------|----------------|----------------|-------------|----------|
| 1 * | 4959.926 | 24.26 | 2.21 | 26.47 | 54.00 | -27.53 | AVG |
| 2 | 4959.938 | 39.74 | 2.21 | 41.95 | 74.00 | -32.05 | peak |

Remarks:
 1. Factor (dB/m) = Antenna Factor (dB/m)+Cable Factor (dB)-Pre-amplifier Factor
 2. Margin value = Level -Limit value



| | |
|-------------------|--|
| Ant. Pol. | Vertical |
| Test Mode: | TX BLE Mode 2480MHz |
| Remark: | No report for the emission which more than 10 dB below the prescribed limit. |

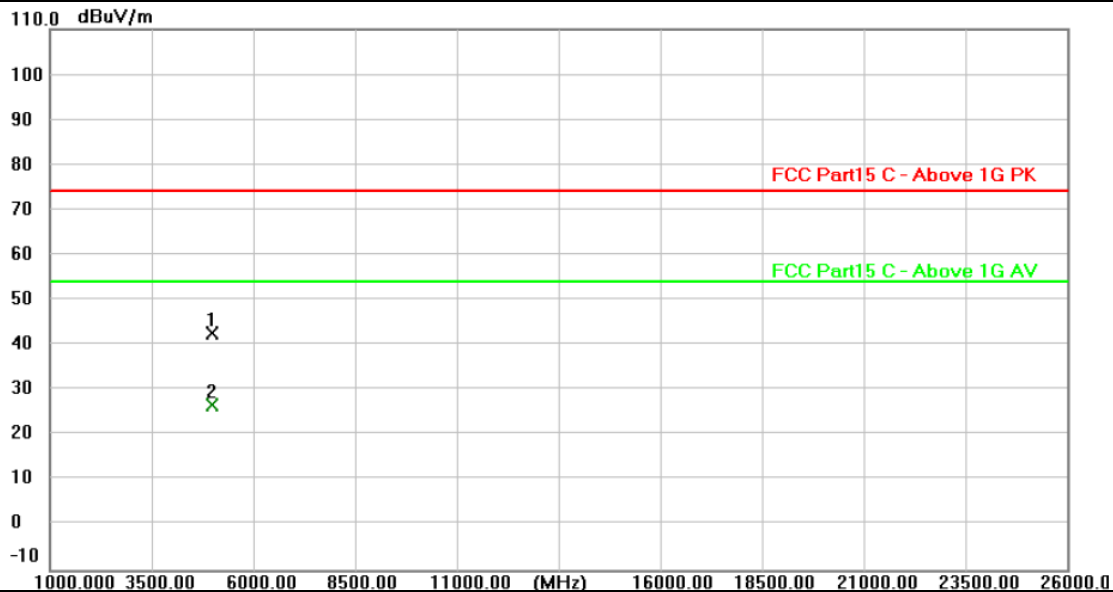

| No. | Frequency (MHz) | Reading (dBuV) | Factor (dB/m) | Level (dBuV/m) | Limit (dBuV/m) | Margin (dB) | Detector |
|-----|-----------------|----------------|---------------|----------------|----------------|-------------|----------|
| 1 | 4959.627 | 40.41 | 2.21 | 42.62 | 74.00 | -31.38 | peak |
| 2 * | 4960.399 | 24.49 | 2.21 | 26.70 | 54.00 | -27.30 | AVG |

Remarks:
 1. Factor (dB/m) = Antenna Factor (dB/m)+Cable Factor (dB)-Pre-amplifier Factor
 2. Margin value = Level -Limit value

3.3. Band Edge Emissions (Radiated)

Limit

FCC CFR Title 47 Part 15 Subpart C Section 15.247 (d)/ RSS 247 5.5:

| Restricted Frequency Band (MHz) | (dBuV/m)(at 3m) | |
|---------------------------------|-----------------|---------|
| | Peak | Average |
| 2310 ~ 2390 | 74 | 54 |
| 2483.5 ~ 2500 | 74 | 54 |

Test Configuration

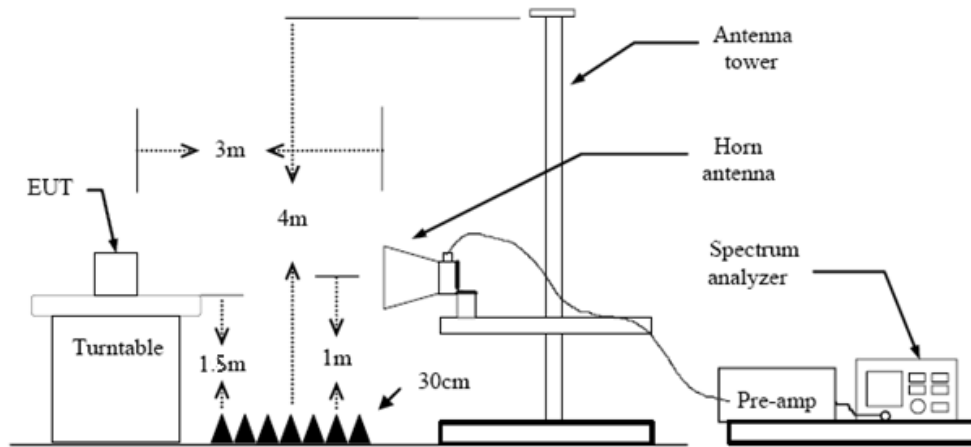

Test Procedure

1. The EUT was setup and tested according to ANSI C63.10:2013 requirements.
2. The EUT is placed on a turn table which is 1.5 meter above ground. The turn table is rotated 360 degrees to determine the position of the maximum emission level.
3. The EUT was positioned such that the distance from antenna to the EUT was 3 meters.
4. The antenna is scanned from 1 meter to 4 meters to find out the maximum emission level. This is repeated for both horizontal and vertical polarization of the antenna. In order to find the maximum emission, all of the interface cables were manipulated according to ANSI C63.10:2013 on radiated measurement.
5. The receiver set as follow:
 RBW=1MHz, VBW=3MHz Peak detector for Peak value.
 RBW=1MHz, VBW see note 1 with Peak Detector for Average Value.

Note 1: For measurements above 1 GHz the resolution bandwidth is set to 1 MHz, then the video bandwidth is set to 3 MHz for peak measurements and 1 MHz resolution bandwidth with 1/T video bandwidth with peak detector for average measurements. For the Duty Cycle please refer to clause 3.8 Duty Cycle.

Test Mode

Please refer to the clause 2.4.



Test Results

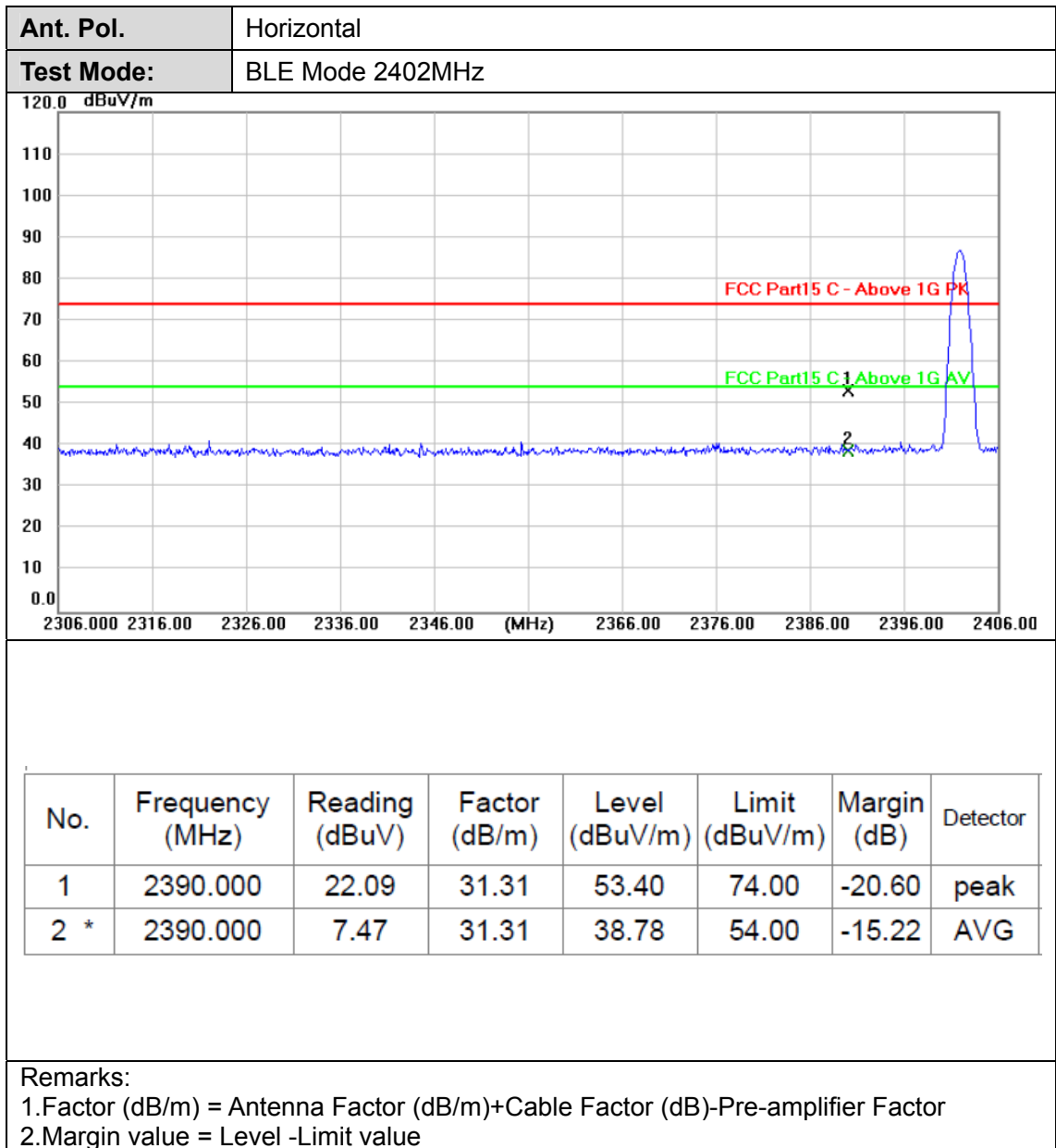



| | |
|-------------------|------------------|
| Ant. Pol. | Vertical |
| Test Mode: | BLE Mode 2402MHz |

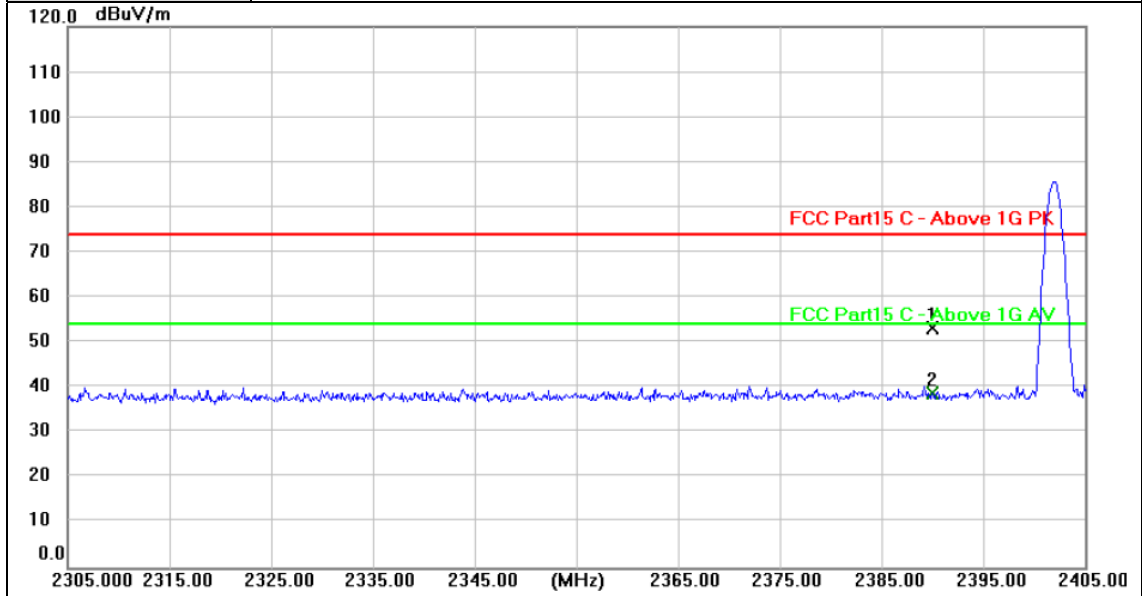

| No. | Frequency (MHz) | Reading (dBuV) | Factor (dB/m) | Level (dBuV/m) | Limit (dBuV/m) | Margin (dB) | Detector |
|-----|-----------------|----------------|---------------|----------------|----------------|-------------|----------|
| 1 | 2390.000 | 21.93 | 31.31 | 53.24 | 74.00 | -20.76 | peak |
| 2 * | 2390.000 | 7.68 | 31.31 | 38.99 | 54.00 | -15.01 | AVG |

Remarks:

- Factor (dB/m) = Antenna Factor (dB/m)+Cable Factor (dB)-Pre-amplifier Factor
- Margin value = Level -Limit value

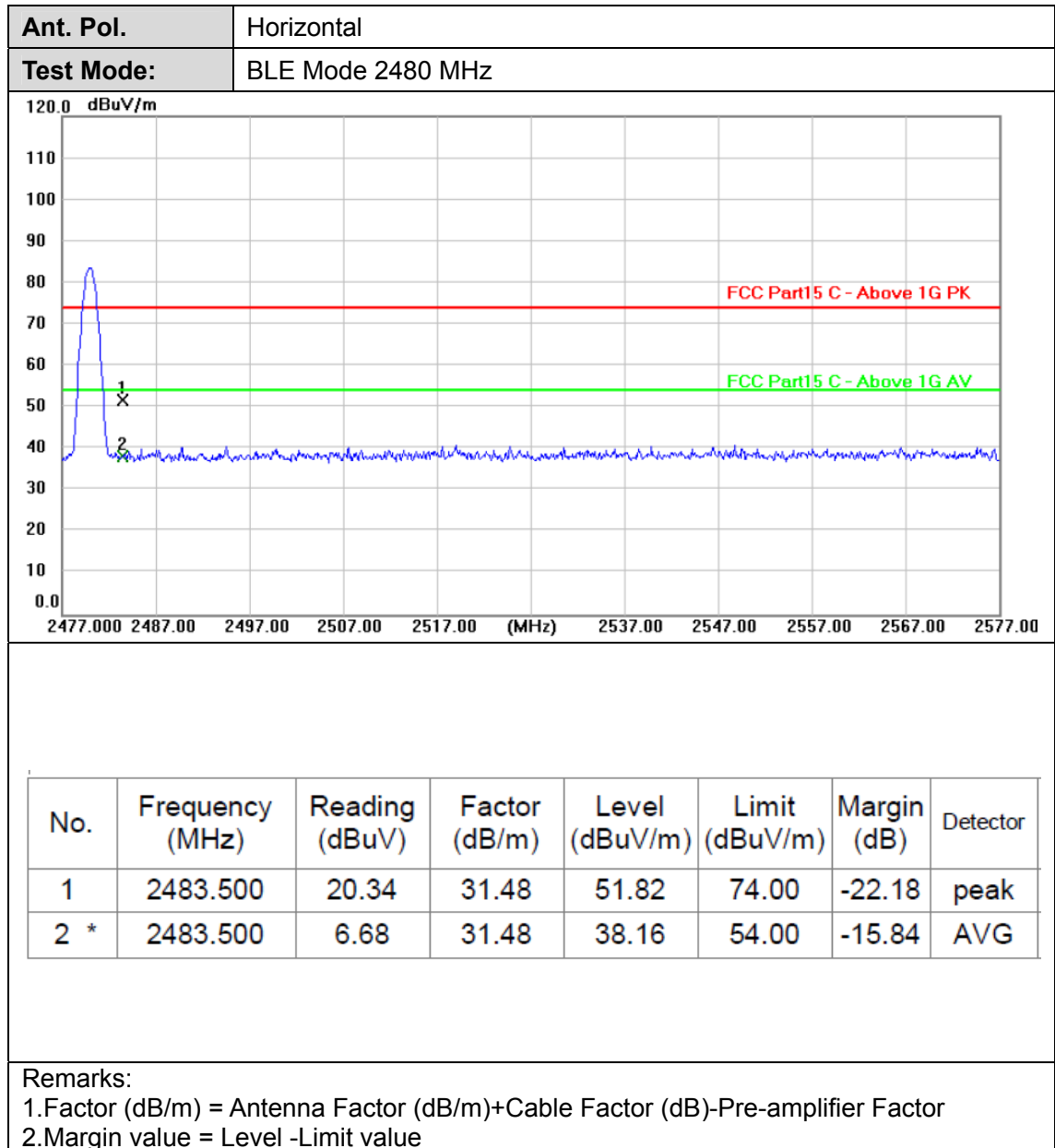



| | | | | | | | |
|--|-------------------|----------------|---------------|----------------|----------------|-------------|----------|
| Ant. Pol. | Vertical | | | | | | |
| Test Mode: | BLE Mode 2480 MHz | | | | | | |
| | | | | | | | |
| No. | Frequency (MHz) | Reading (dBuV) | Factor (dB/m) | Level (dBuV/m) | Limit (dBuV/m) | Margin (dB) | Detector |
| 1 | 2483.500 | 22.01 | 31.48 | 53.49 | 74.00 | -20.51 | peak |
| 2 * | 2483.500 | 7.02 | 31.48 | 38.50 | 54.00 | -15.50 | AVG |
| Remarks: 1. Factor (dB/m) = Antenna Factor (dB/m)+Cable Factor (dB)-Pre-amplifier Factor 2. Margin value = Level -Limit value | | | | | | | |

3.4. Band edge and Spurious Emissions (Conducted)

Limit

FCC CFR Title 47 Part 15 Subpart C Section 15.247 (d): In any 100 kHz bandwidth outside the frequency band in which the spread spectrum intentional radiator is operating, the radio frequency power that is produced by the intentional radiator shall be at least 20 dB below that in the 100 kHz bandwidth within the band that contains the highest level of the desired power, based on either an RF conducted or a radiated measurement.

Test Configuration

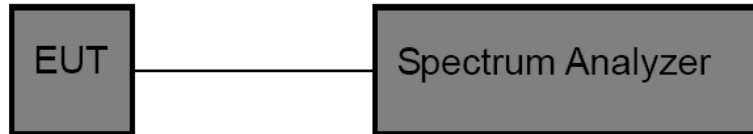

Test Procedure

1. The transmitter output was connected to the spectrum analyzer through an attenuator, the path loss was compensated to the results for each measurement.
2. Set to the maximum power setting and enable the EUT transmit continuously
3. Use the following spectrum analyzer settings:
RBW = 100 kHz, VBW \geq RBW, scan up through 10th harmonic.
Sweep = auto, Detector function = peak, Trace = max hold
4. Measure and record the results in the test report.

Test Mode

Please refer to the clause 2.4.

Test Results

(1) Band edge Conducted Test

| Test Mode | Frequency[MHz] | Ref Level[dBm] | Result[dBm] | Limit[dBm] | Verdict |
|-----------|----------------|----------------|-------------|---------------|---------|
| BLE | 2402 | -1.020 | -58.663 | \leq -21.02 | PASS |
| | 2480 | -1.436 | -60.736 | \leq -21.44 | PASS |



BLE_Low_2402

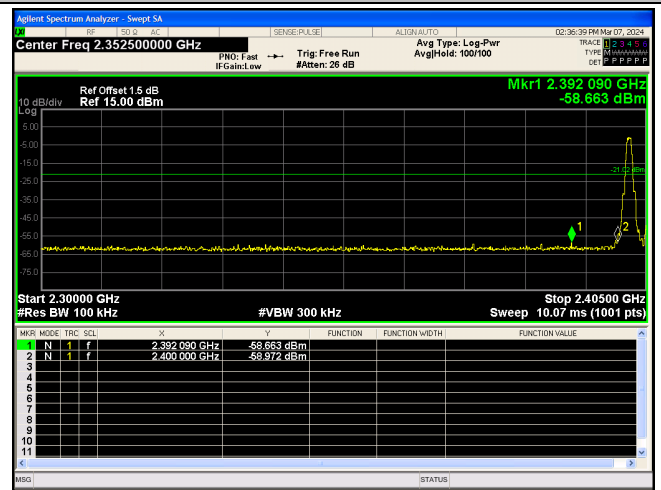
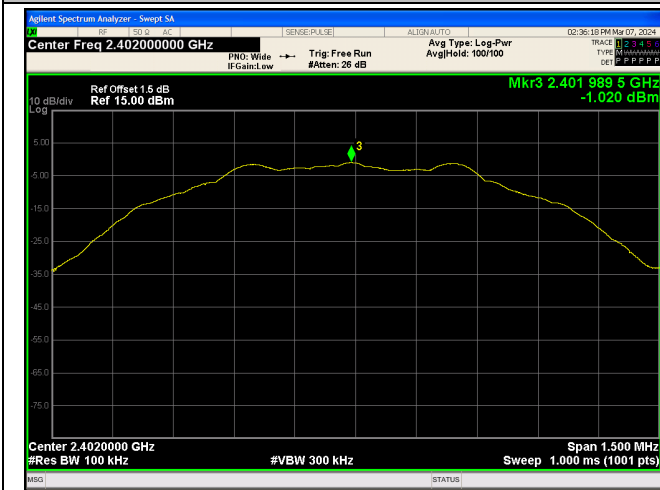

BLE_High_2480

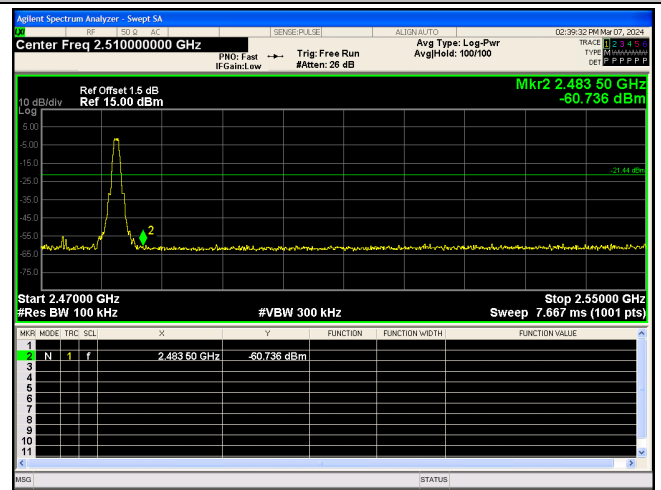
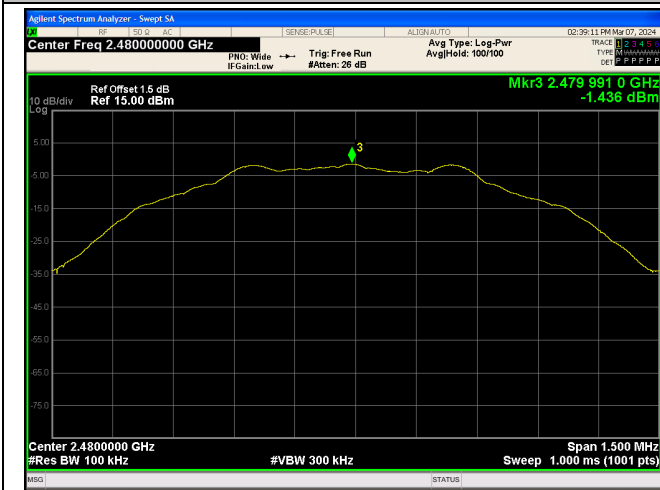

CTC Laboratories, Inc.

1-2/F., Building 2, Jiaquan Building, Guanlan High-Tech Park, Shenzhen, Guangdong, China
Tel.: (86)755-27521059

Fax: (86)755-27521011 Http://www.sz-ctc.org.cn
For anti-fake verification, please visit the official website of Certification and Accreditation Administration of the People's Republic of China : yz.cnca.cn



**(2) Conducted Spurious Emissions Test**

| Test Mode | Frequency [MHz] | Freq Range [MHz] | Ref Level [dBm] | Result[dBm] | Limit[dBm] | Verdict |
|-----------|-----------------|------------------|-----------------|-------------|---------------|---------|
| BLE | 2402 | Reference | -1.020 | -1.020 | --- | PASS |
| | | 30~25000 | -1.020 | -46.073 | ≤ -21.02 | PASS |
| | 2440 | Reference | -1.474 | -1.474 | --- | PASS |
| | | 30~25000 | -1.474 | -45.916 | ≤ -21.47 | PASS |
| | 2480 | Reference | -1.436 | -1.436 | --- | PASS |
| | | 30~25000 | -1.436 | -45.113 | ≤ -21.44 | PASS |



BLE_2402_0~Reference

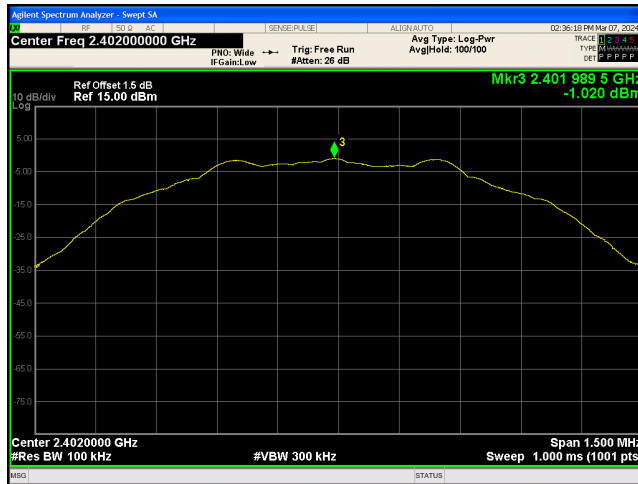

BLE_2402_30~25000

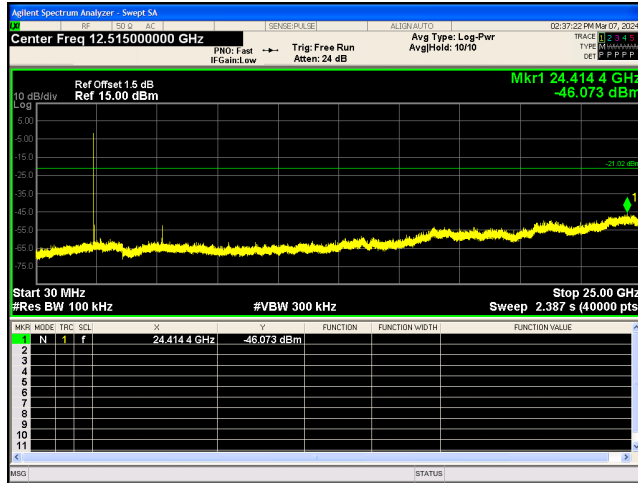

BLE_2440_0~Reference

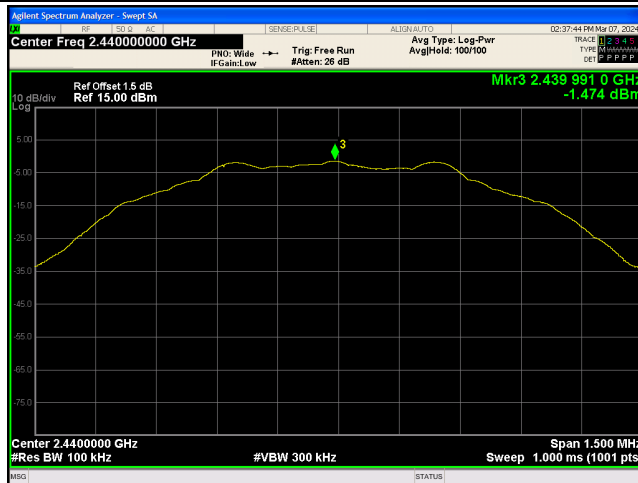

BLE_2440_30~25000

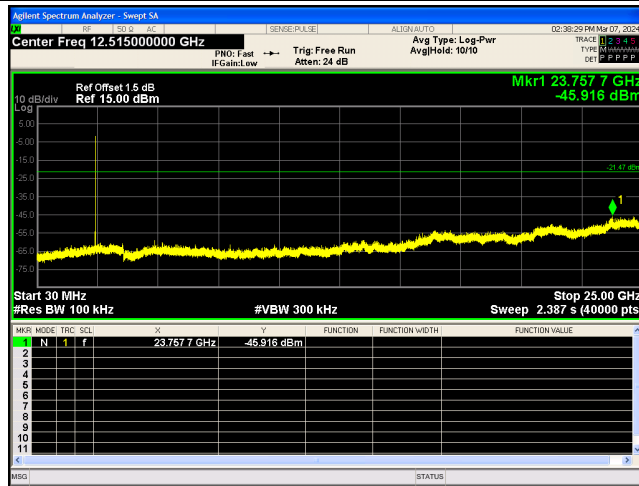

BLE_2480_0~Reference

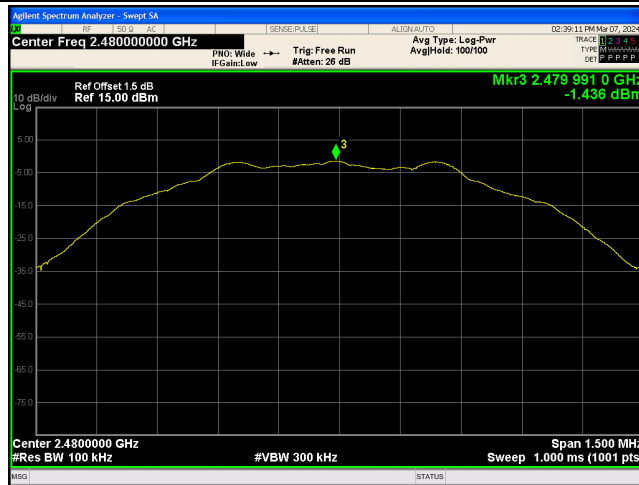

BLE_2480_30~25000

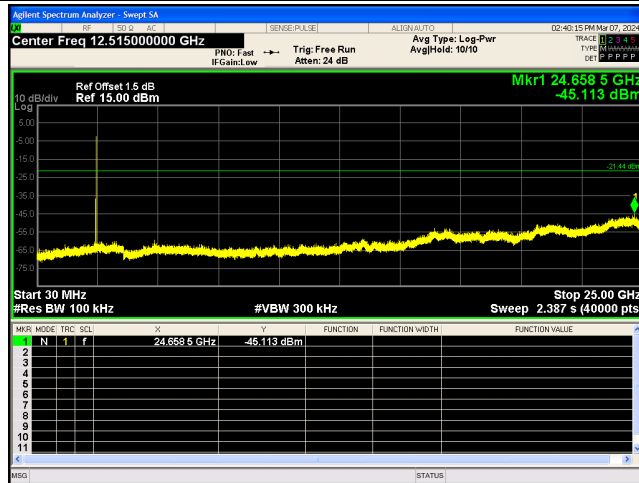



3.5. DTS Bandwidth

Limit

FCC CFR Title 47 Part 15 Subpart C Section 15.247 (a)(2)/ RSS-247 5.2 a:

| Test Item | Limit | Frequency Range(MHz) |
|---------------|-----------------------------------|----------------------|
| DTS Bandwidth | ≥ 500 KHz (6dB bandwidth) | 2400~2483.5 |

Test Configuration

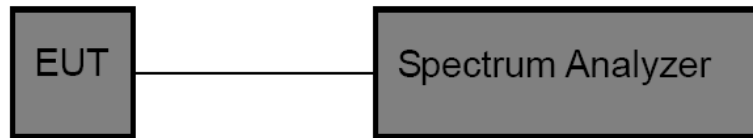

Test Procedure

5. The EUT was directly connected to the spectrum analyzer and antenna output port as show in the block diagram above.
6. DTS Spectrum Setting:
 - (1) Set RBW = 100 kHz.
 - (2) Set the video bandwidth (VBW) ≥ 3 RBW.
 - (3) Detector = Peak.
 - (4) Trace mode = Max hold.
 - (5) Sweep = Auto couple.
- OCB Spectrum Setting:
 - (1) Set RBW = 1% ~ 5% occupied bandwidth.
 - (2) Set the video bandwidth (VBW) ≥ 3 RBW.
 - (3) Detector = Peak.
 - (4) Trace mode = Max hold.
 - (5) Sweep = Auto couple.

Test Mode

Please refer to the clause 2.4.

Test Results

| Test Mode | Frequency[MHz] | DTS BW[MHz] | Limit[MHz] | Verdict |
|-----------|----------------|-------------|------------|---------|
| BLE | 2402 | 0.686 | ≥ 0.5 | PASS |
| | 2440 | 0.685 | ≥ 0.5 | PASS |
| | 2480 | 0.673 | ≥ 0.5 | PASS |



BLE_2402

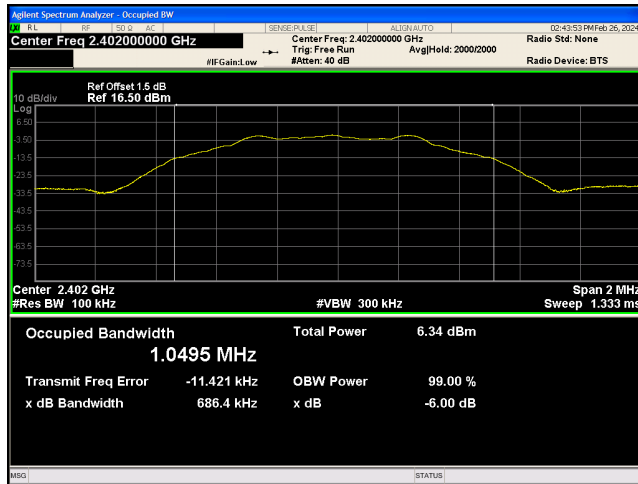

BLE_2440

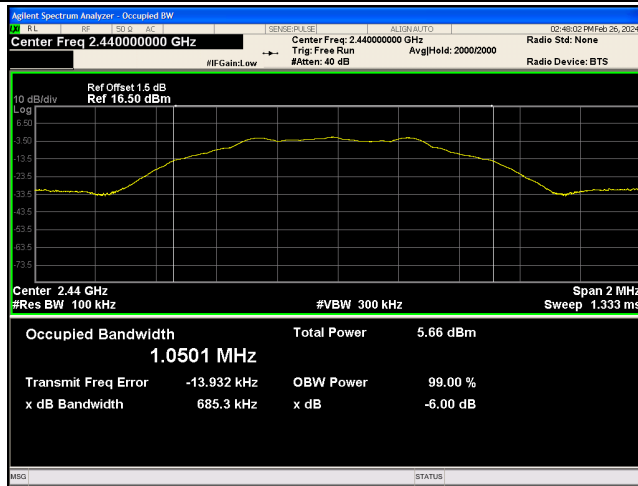

BLE_2480

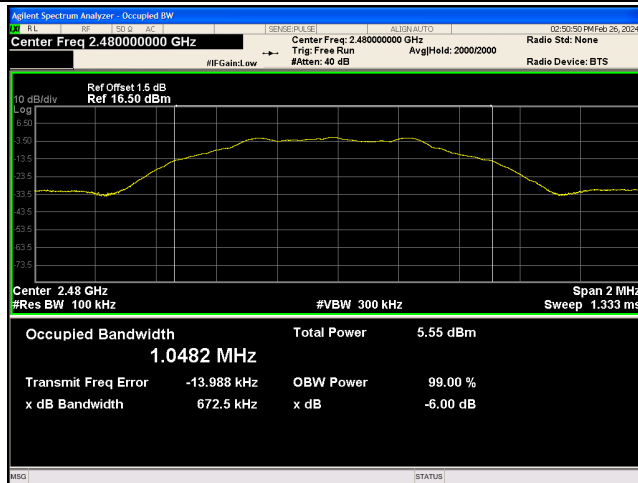



3.6. Peak Output Power

Limit

FCC CFR Title 47 Part 15 Subpart C Section 15.247 (b)(3)/ RSS-247 5.4 d:

| Section | Test Item | Limit | Frequency Range(MHz) |
|-------------------------|--------------------------------|-----------------|----------------------|
| CFR 47 FCC 15.247(b)(3) | Maximum conducted output power | 1 Watt or 30dBm | 2400~2483.5 |
| ISED RSS-247 5.4 d | EIRP | 4 Watt or 36dBm | 2400~2483.5 |

Test Configuration

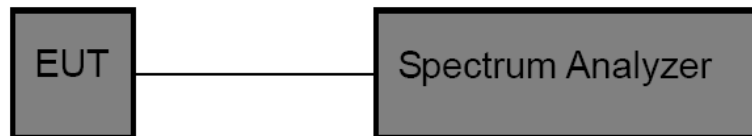

Test Procedure

- The EUT was directly connected to the spectrum analyzer and antenna output port as show in the block diagram above.
- Spectrum Setting:
 Peak Detector: $RBW \geq DTS \text{ Bandwidth}$, $VBW \geq 3 * RBW$.
 Sweep time=Auto.
 Detector= Peak.
 Trace mode= Maxhold.
 Allow trace to fully stabilize. Then use the peak marker function to determine the maximum amplitude level.

Test Mode

Please refer to the clause 2.4.

Test Result

| Test Mode | Frequency[MHz] | Result[dBm] | Limit[dBm] | Verdict |
|-----------|----------------|-------------|------------|---------|
| BLE | 2402 | 0.097 | ≤ 30 | PASS |
| | 2440 | -0.808 | ≤ 30 | PASS |
| | 2480 | -0.799 | ≤ 30 | PASS |



Test plot as follows:

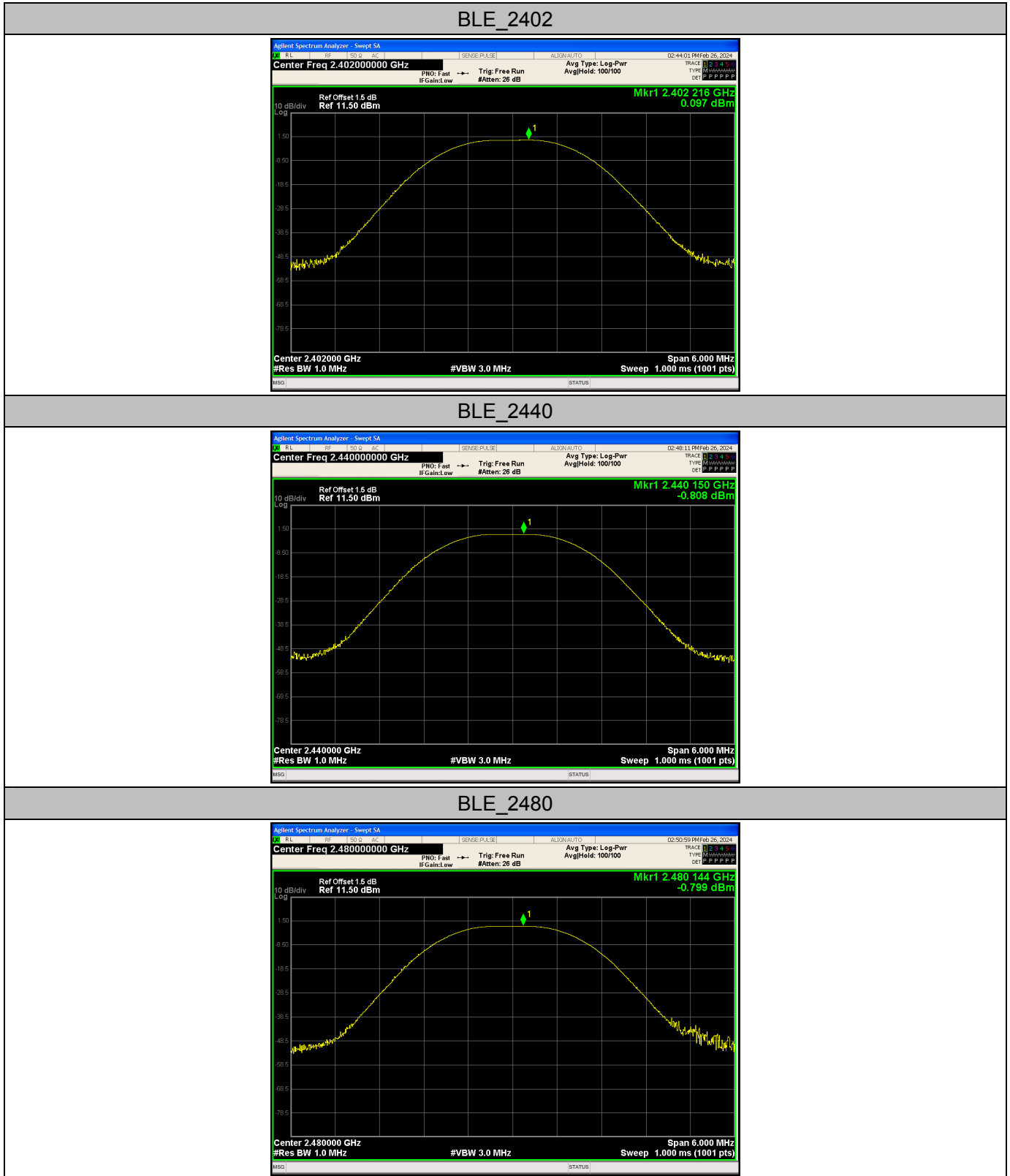

CTC Laboratories, Inc.

1-2/F., Building 2, Jiaquan Building, Guanlan High-Tech Park, Shenzhen, Guangdong, China
Tel.: (86)755-27521059

Fax: (86)755-27521011 [Http://www.sz-ctc.org.cn](http://www.sz-ctc.org.cn)



For anti-fake verification, please visit the official website of Certification and Accreditation Administration of the People's Republic of China : yz.cnca.cn



3.7. Power Spectral Density

Limit

FCC CFR Title 47 Part 15 Subpart C Section 15.247 (e)/ RSS-247 5.2 b:

| Test Item | Limit | Frequency Range(MHz) |
|------------------------|--------------------|----------------------|
| Power Spectral Density | 8dBm(in any 3 kHz) | 2400~2483.5 |

Test Configuration

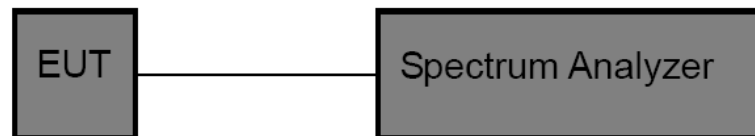

Test Procedure

- The EUT was directly connected to the spectrum analyzer and antenna output port as show in the block diagram above.
- The EUT was directly connected to the Spectrum Analyzer and antenna output port as show in the block diagram above. The measurement according to section 10.2 of KDB 558074 D01 DTS Meas Guidance v05r02.
- Spectrum Setting:
Set analyzer center frequency to DTS channel center frequency.
Set the span to 1.5 times the DTS bandwidth.
Set the RBW to: 3 kHz
Set the VBW to: 10 kHz
Detector: peak
Sweep time: auto
Allow trace to fully stabilize. Then use the peak marker function to determine the maximum amplitude level.

Test Mode

Please refer to the clause 2.4.

Test Result

| Test Mode | Frequency[MHz] | Result[dBm/3kHz] | Limit[dBm/3kHz] | Verdict |
|-----------|----------------|------------------|-----------------|---------|
| BLE | 2402 | -14.973 | <=8 | PASS |
| | 2440 | -15.739 | <=8 | PASS |
| | 2480 | -15.720 | <=8 | PASS |



BLE_2402

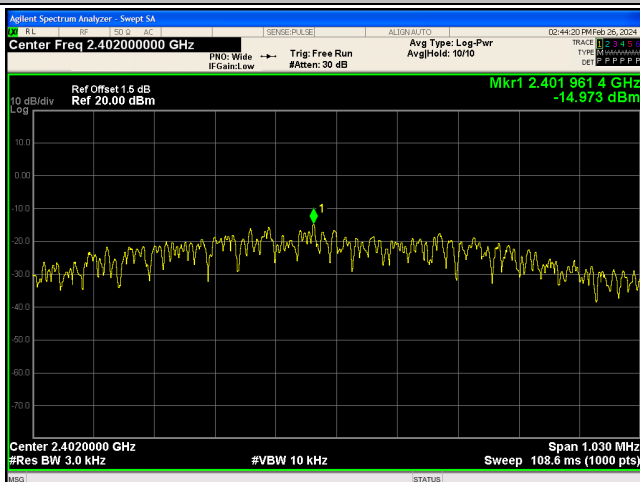

BLE_2440

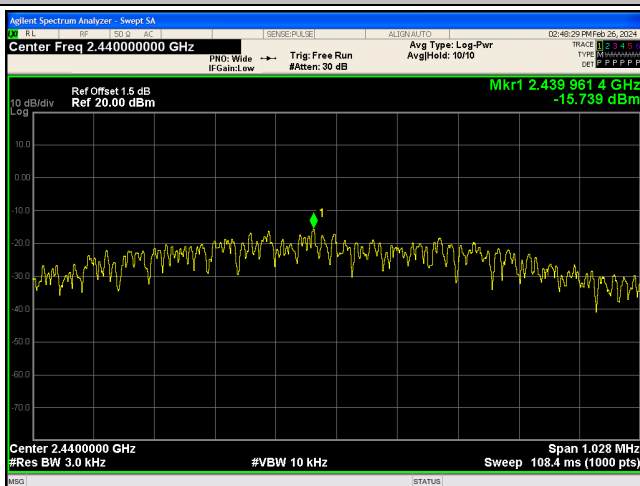

BLE_2480

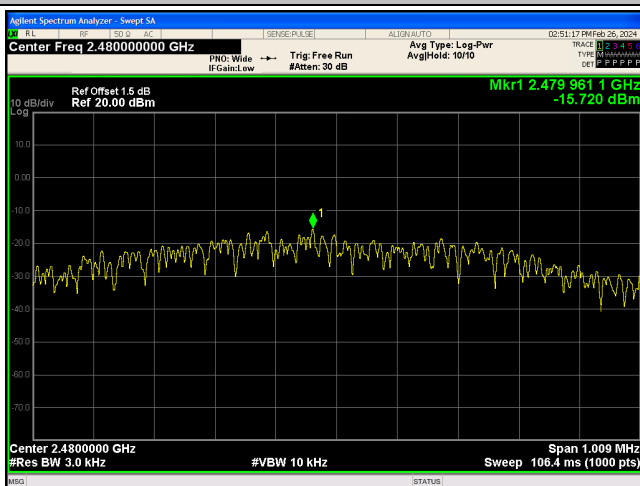

CTC Laboratories, Inc.

1-2/F., Building 2, Jiaquan Building, Guanlan High-Tech Park, Shenzhen, Guangdong, China
Tel.: (86)755-27521059

Fax: (86)755-27521011 Http://www.sz-ctc.org.cn
For anti-fake verification, please visit the official website of Certification and Accreditation Administration of the People's Republic of China : yz.cnca.cn



3.8. Duty Cycle

Limit

None, for report purposes only.

Test Configuration

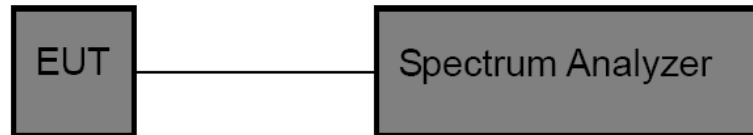

Test Procedure

1. The EUT was directly connected to the spectrum analyzer and antenna output port as show in the block diagram above.
2. The EUT was directly connected to the Spectrum Analyzer and antenna output port as show in the block diagram above. The measurement according to section 10.2 of KDB 558074 D01 DTS Meas Guidance v05r02.
3. Spectrum Setting:
Set analyzer center frequency to test channel center frequency.
Set the span to 0Hz
Set the RBW to 8MHz
Set the VBW to 8MHz
Detector: Peak
Sweep time: Auto
Allow trace to fully stabilize. Then use the peak marker function to determine the maximum amplitude level.

Test Mode

Please refer to the clause 2.4.

Test Result

| Test Mode | Frequency [MHz] | Transmission Duration [ms] | Transmission Period [ms] | Duty Cycle [%] | 1/T Minimum VBW (kHz) | Final setting For VBW (kHz) |
|-----------|-----------------|----------------------------|--------------------------|----------------|-----------------------|-----------------------------|
| BLE | 2402 | 0.381 | 0.622 | 61.20 | 2.625 | 3 |
| | 2440 | 0.384 | 0.622 | 61.75 | 2.604 | 3 |
| | 2480 | 0.381 | 0.622 | 61.20 | 2.625 | 3 |



BLE_2402

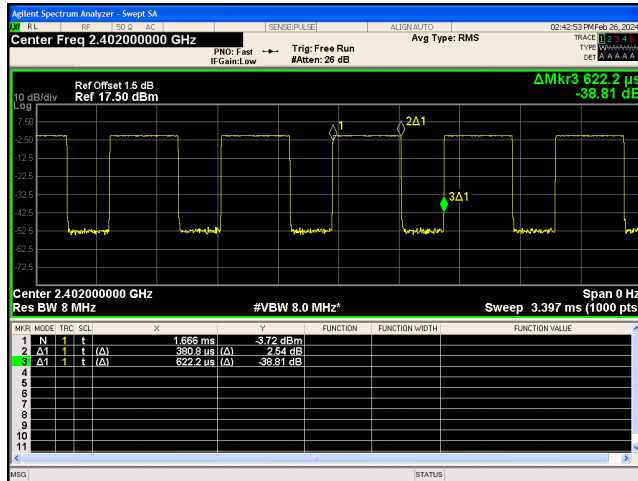

BLE_2440

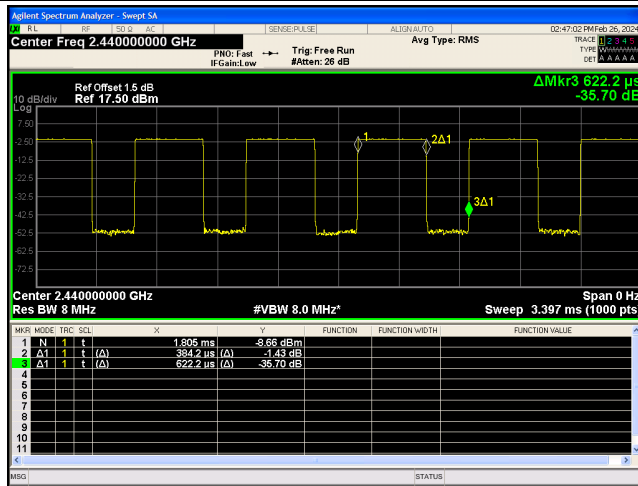

BLE_2480

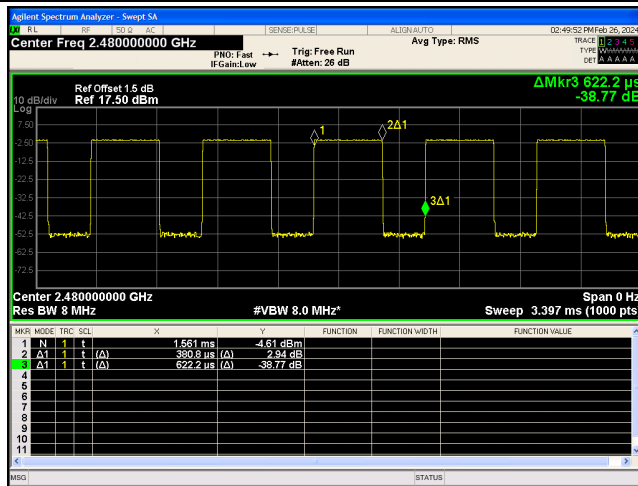



3.9. Antenna requirement

Requirement

FCC CFR Title 47 Part 15 Subpart C Section 15.203:

An intentional radiator shall be designed to ensure that no antenna other than that furnished by the responsible party shall be used with the device. The use of a permanently attached antenna or of antenna that uses a unique coupling to the intentional radiator, the manufacturer may design the unit so that a broken antenna can be replaced by the user, but the use of a standard antenna jack or electrical connector is prohibited.

FCC CFR Title 47 Part 15 Subpart C Section 15.247(c) (1)(i):

(i) Systems operating in the 2400~2483.5 MHz band that is used exclusively for fixed. Point-to-point operations may employ transmitting antennas with directional gain greater than 6dBi provided the maximum conducted output power of the intentional radiator is reduced by 1 dB for every 3 dB that the directional gain of the antenna exceeds 6dBi.

Test Result

The directional gain of the antenna less than 6dBi, please refer to the EUT internal photographs antenna photo.

*****THE END*****