



**Shenzhen Global Test Service Co.,Ltd.**

No.7-101 and 8A-104, Building 7 and 8, DCC Cultural and Creative Garden, No.98, Pingxin North Road, Shangmugu Community, Pinghu Street, Longgang District, Shenzhen, Guangdong

## FCC PART 15 SUBPART C TEST REPORT

### FCC PART 15.407

**Report Reference No.....: GTS20230704026-1-23**

**FCC ID.....: 2AYD5-I23D01**

Compiled by

( position+printed name+signature) .: File administrators Peter Xiao

Supervised by

( position+printed name+signature) .: Test Engineer Evan Ouyang

Approved by

( position+printed name+signature) .: Manager Jason Hu



Date of issue .....: Aug.18, 2023

**Representative Laboratory Name.:** Shenzhen Global Test Service Co.,Ltd.

Address .....: No.7-101 and 8A-104, Building 7 and 8, DCC Cultural and Creative Garden, No.98, Pingxin North Road, Shangmugu Community, Pinghu Street, Longgang District, Shenzhen, Guangdong,China

**Applicant's name.....: Imin Technology Pte Ltd**

Address .....: 11 Bishan Street 21, #03-05 Bosch Building, Singapore 573943

**Test specification .....**

Standard.....: **FCC Part 15.407: General technical requirements**

TRF Originator.....: Shenzhen Global Test Service Co.,Ltd.

Master TRF .....: Dated 2014-12

**Shenzhen Global Test Service Co.,Ltd. All rights reserved.**

This publication may be reproduced in whole or in part for non-commercial purposes as long as the Shenzhen Global Test Service Co.,Ltd. is acknowledged as copyright owner and source of the material. Shenzhen Global Test Service Co.,Ltd. takes no responsibility for and will not assume liability for damages resulting from the reader's interpretation of the reproduced material due to its placement and context.

**Test item description .....** POS Device

Trade Mark .....:

Manufacturer .....: Imin Technology Pte Ltd

Model/Type reference .....: I23D01

Listed Models .....: N/A

Operation Frequency.....: From 5180MHz to 5240MHz/ 5260MHz to 5320MHz/ 5500MHz to 5700MHz/ 5745MHz to 5825MHz

Hardware Version .....: N/A

Software Version.....: N/A

Rating .....: DC 24V/2.5A by adapter

Result .....: **PASS**

# TEST REPORT

<b>Test Report No. :</b> GTS20230704026-1-23	Aug.18, 2023 Date of issue
--	-------------------------------

Equipment under Test : POS Device

Model /Type : I23D01

Listed model : N/A

**Applicant** : **Imin Technology Pte Ltd**

Address : 11 Bishan Street 21, #03-05 Bosch Building, Singapore 573943

**Manufacturer** : **Imin Technology Pte Ltd**

Address : 11 Bishan Street 21, #03-05 Bosch Building, Singapore 573943

<b>Test Result:</b>	<b>PASS</b>
---------------------	-------------

The test report merely corresponds to the test sample.  
It is not permitted to copy extracts of these test result without the written permission of the test laboratory.

## Contents

<b>1. TEST STANDARDS .....</b>	<b>4</b>
<b>2. SUMMARY .....</b>	<b>5</b>
2.1. General Remarks .....	5
2.2. Product Description .....	5
2.3. Equipment Under Test .....	6
2.4. Short description of the Equipment under Test (EUT) .....	6
2.5. EUT operation mode .....	6
2.6. Block Diagram of Test Setup .....	7
2.7. Related Submittal(s) / Grant (s) .....	8
2.8. EUT Exercise Software .....	8
2.9. Special Accessories .....	8
2.10. External I/O Cable .....	8
2.11. Modifications .....	8
<b>3. TEST ENVIRONMENT .....</b>	<b>9</b>
3.1. Address of the test laboratory .....	9
3.2. Test Facility .....	9
3.3. Environmental conditions .....	9
3.4. Statement of the measurement uncertainty .....	9
3.5. Test Description .....	10
3.6. Equipments Used during the Test.....	12
<b>4. TEST CONDITIONS AND RESULTS .....</b>	<b>13</b>
4.1. AC Power Conducted Emission .....	13
4.2. Radiated Emission .....	26
4.3. Duty Cycle .....	45
4.4. Maximum Average Output Power .....	46
4.5. Power Spectral Density .....	50
4.6. 99% and 6dB Bandwidth .....	56
4.7. 99% and 26dBc Bandwidth .....	57
4.8. Conducted Spurious Emissions and Band Edge Compliance .....	58
4.9. Frequency Stability.....	63
4.10. Antenna Requirement .....	67
<b>5. TEST SETUP PHOTOS OF THE EUT.....</b>	<b>68</b>
<b>6. EXTERNAL AND INTERNAL PHOTOS OF THE EUT .....</b>	<b>68</b>

## 1. TEST STANDARDS

The tests were performed according to following standards:

[FCC Rules Part 15.407](#): General technical requirements.

[ANSI C63.10-2020](#): American National Standard for Testing Unlicensed Wireless Devices

[KDB 789033 D02 General U-NII Test Procedures New Rules v02r01](#): UNII, U-NII, U-NII Test Procedures

## 2. SUMMARY

### 2.1. General Remarks

Date of receipt of test sample	:	Jul.21, 2023
Testing commenced on	:	Jul.21, 2023
Testing concluded on	:	Aug.17, 2023

### 2.2. Product Description

Product Name:	POS Device
Trade Mark:	
Model/Type reference:	I23D01
List Model:	N/A
Model Declaration	N/A
Power supply:	DC 24V/2.5A by adapter
Hardware Version	N/A
Software Version	N/A
Sample ID	GTS20230704026-1-S0001-1#& GTS20230704026-1-S0001-2#
Bluetooth	
Frequency Range	2402MHz ~ 2480MHz
Channel Number	79 channels for Bluetooth (DSS) 40 channels for Bluetooth (DTS)
Channel Spacing	1MHz for Bluetooth (DSS) 2MHz for Bluetooth (DTS)
Modulation Type	GFSK, $\pi/4$ -DQPSK, 8DPSK for Bluetooth (DSS) GFSK for Bluetooth (DTS)
2.4GWLAN	
WLAN Operation frequency	IEEE 802.11b:2412-2462MHz IEEE 802.11g:2412-2462MHz IEEE 802.11n HT20:2412-2462MHz IEEE 802.11ax HE20:2412-2462MHz
WLAN Modulation Type	IEEE 802.11b: DSSS(CCK,DQPSK,DBPSK) IEEE 802.11g: OFDM(64QAM, 16QAM, QPSK, BPSK) IEEE 802.11n HT20: OFDM (64QAM, 16QAM, QPSK,BPSK) IEEE 802.11ax HE20: OFDMA (1024QAM,256QAM,64QAM,16QAM, QPSK,BPSK)
Channel number:	11 Channel for IEEE 802.11b/g/n/ax (HT20)
Channel separation:	5MHz
WIFI(5.2G/5.3G/5.7G/5.8G Band)	
WLAN Operation frequency	5180-5240MHz/ 5260MHz to 5320MHz/ 5500MHz to 5700MHz/ 5745MHz to 5825MHz
WLAN Modulation Type	IEEE 802.11a: OFDM(64QAM, 16QAM, QPSK, BPSK) IEEE 802.11n HT20: OFDM (64QAM, 16QAM, QPSK,BPSK) IEEE 802.11ac VHT20: OFDM (256QAM,64QAM, 16QAM, QPSK,BPSK) IEEE 802.11ax HE20: OFDMA (1024QAM,256QAM,64QAM, 16QAM, QPSK,BPSK) IEEE 802.11n HT40: OFDM (64QAM, 16QAM, QPSK,BPSK) IEEE 802.11ac VHT40: OFDM (256QAM,64QAM, 16QAM, QPSK,BPSK)



IEEE 802.11a/ac20/ac40/ac80/ax20/ax40/ax80/n20/n40:

UNII-1		UNII-1		UNII-1	
Channel	Frequency (MHz)	Channel	Frequency (MHz)	Channel	Frequency (MHz)
<b>36</b>	<b>5180</b>	38	5190	42	5210
<b>40</b>	<b>5200</b>	46	5230		
44	5220				
<b>48</b>	<b>5240</b>				

U-NI-2A		U-NI-2A		U-NI-2A	
Channel	Frequency (MHz)	Channel	Frequency (MHz)	Channel	Frequency (MHz)
52	5260	54	5270	58	5290
56	5280	62	5310		
60	5300				
64	5320				

U-NI-2C		U-NI-2C		U-NI-2C	
Channel	Frequency (MHz)	Channel	Frequency (MHz)	Channel	Frequency (MHz)
100	5500	102	5510	106	5530
104	5520	110	5550	122	5610
108	5540	118	5590		
112	5560	126	5630		
116	5580	134	5670		
120	5600				
124	5620				
128	5640				
132	5660				
136	5680				
140	5700				

U-NI-3		U-NI-3		U-NI-3	
Channel	Frequency (MHz)	Channel	Frequency (MHz)	Channel	Frequency (MHz)
<b>149</b>	<b>5745</b>	151	5755	155	5775
153	5765	159	5795		
<b>157</b>	<b>5785</b>				
161	5805				
<b>165</b>	<b>5825</b>				

The EUT has been tested under operating condition.

This test was performed with EUT in X, Y, Z position and the worst case was found when EUT in X position.

AC main conducted emission pre-test voltage at both AC 120V/60Hz and AC 240V/60Hz, recorded worst case;

AC main conducted emission pre-test at charge from PC modes, recorded worst case;

Worst-case mode and channel used for 9 KHz-1000 MHz radiated emissions was the mode and channel with the highest output power, that was determined to be IEEE 802.11ac VHT20 mode (HCH).

AX mode tested all RU, only worst case mode (Full RU) recorded in report.

## 2.6. Block Diagram of Test Setup

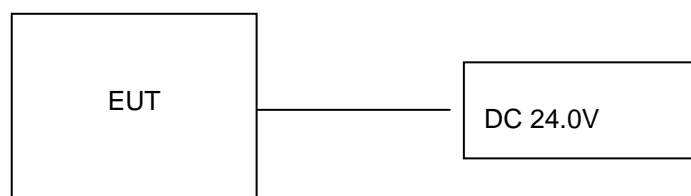

## 2.7. Related Submittal(s) / Grant (s)

This submittal(s) (test report) is intended for **FCC ID: 2AYD5-I23D01** filing to comply with Section 15.407 of the FCC Part 15, Subpart E Rules.

## 2.8. EUT Exercise Software

The system was configured for testing in a continuous transmits condition and change test channels by software (adb model) provided by application.

## 2.9. Special Accessories

Manufacturer	Description	Model	Serial Number	Certificate
Jiangsu Chenyang Electron Co.,Ltd.	Adapter	CYSE65-240250	--	SDOC
Shenzhen SOY Technology Co.,Ltd.	Adapter	SOY-2400250-332-A	--	SDOC
JiangSu Sunward Electronic Technology Co., Ltd	Adapter	AD65CM249250A	--	SDOC
SHENZHEN HONOR ELECTRONIC CO.,LTD.	Adapter	ADS-65HI-19A-1 24060E	--	SDOC
LENOVO	PC	DESKYOP-EUIVCNR	--	SDOC
LENOVO	Keyboard	T460S	--	SDOC
LENOVO	Mouse	Howard	--	SDOC
SONY	Earphone	MDR-XB550AP	--	SDOC
aigo	USB flash disk	U330	--	SDOC

Note: The PC, Keyboard, Mouse, Earphone and USB flash disk is only used for auxiliary testing.

## 2.10. External I/O Cable

I/O Port Description	Quantity	Cable
DC IN Port	1	Non-Shielded, 1.0m
USB Port	3	N/A
LAN Port	1	Non-Shielded, 10m
Type-C Port	1	N/A
TF Cart	1	N/A
RJ11 Port	2	N/A
Earphone	1	N/A

## 2.11. Modifications

No modifications were implemented to meet testing criteria.



### 3. TEST ENVIRONMENT

#### 3.1. Address of the test laboratory

**Shenzhen Global Test Service Co.,Ltd.**

No.7-101 and 8A-104, Building 7 and 8, DCC Cultural and Creative Garden, No.98, Pingxin North Road, Shangmugu Community, Pinghu Street, Longgang District, Shenzhen, Guangdong, China.

#### 3.2. Test Facility

The test facility is recognized, certified, or accredited by the following organizations:

CNAS (No. CNAS L8169)

Shenzhen Global Test Service Co., Ltd. has been assessed and proved to be in compliance with CNAS-CL01 Accreditation Criteria for Testing and Calibration Laboratories (identical to ISO/IEC 17025: 2019 General Requirements) for the Competence of Testing and Calibration Laboratories.

A2LA (Certificate No. 4758.01)

Shenzhen Global Test Service Co., Ltd. has been assessed by the American Association for Laboratory Accreditation (A2LA). Certificate No. 4758.01.

Industry Canada Registration Number. is 24189.

FCC Designation Number is CN1234.

FCC Registered Test Site Number is165725.

#### 3.3. Environmental conditions

During the measurement the environmental conditions were within the listed ranges:

Temperature:	15-35 ° C
Humidity:	30-60 %
Atmospheric pressure:	950-1050mbar

#### 3.4. Statement of the measurement uncertainty

The data and results referenced in this document are true and accurate. The reader is cautioned that there may be errors within the calibration limits of the equipment and facilities. The measurement uncertainty was calculated for all measurements listed in this test report acc. to CISPR 16 - 4 „Specification for radio disturbance and immunity measuring apparatus and methods – Part 4: Uncertainty in EMC Measurements“ and is documented in the Shenzhen Global Test Service Co.,Ltd quality system acc. to DIN EN ISO/IEC 17025. Furthermore, component and process variability of devices similar to that tested may result in additional deviation. The manufacturer has the sole responsibility of continued compliance of the device.

Hereafter the best measurement capability for Shenzhen GTS laboratory is reported:

Test	Range	Measurement Uncertainty	Notes
Radiated Emission	30~1000MHz	4.10 dB	(1)
Radiated Emission	1~18GHz	4.32 dB	(1)
Radiated Emission	18-40GHz	5.54 dB	(1)
Conducted Disturbance	0.15~30MHz	3.12 dB	(1)

This uncertainty represents an expanded uncertainty expressed at approximately the 95% confidence level using a coverage factor of k=2.

### 3.5. Test Description

Applied Standard: FCC Part 15 Subpart E				
FCC Rules	Description of Test	Test Sample	Result	Remark
/	On Time and Duty Cycle	GTS20230704026-1-S0001-1#	Compliant	Appendix D Appendix E Appendix F Appendix G
§15.407(a)	Maximum Conducted Output Power	GTS20230704026-1-S0001-1#	Compliant	Appendix D Appendix E Appendix F Appendix G
§15.407(a)	Power Spectral Density	GTS20230704026-1-S0001-1#	Compliant	Appendix D Appendix E Appendix F Appendix G
§15.407(a)	26dB&6dB Bandwidth and 99% Bandwidth	GTS20230704026-1-S0001-1#	Compliant	Appendix D Appendix E Appendix F Appendix G
§15.209, §15.407(b)	Radiated Emissions	GTS20230704026-1-S0001-1# GTS20230704026-1-S0001-2#	Compliant	Note 1
§15.209, §15.407(b)	Conducted Spurious Emissions and Band Edges Test	GTS20230704026-1-S0001-1#	Compliant	Appendix D Appendix E Appendix F Appendix G
§15.209, §15.407(b)	Emissions at Restricted Band	GTS20230704026-1-S0001-1#	Compliant	Note 1
§15.407(g)	Frequency Stability	GTS20230704026-1-S0001-1#	Compliant	Note 1
§15.207(a)	AC Mians Line Conducted Emissions	GTS20230704026-1-S0001-2#	Compliant	Note 1
§15.203 §15.407(h)	Antenna Requirements	GTS20230704026-1-S0001-1#	Compliant	Note 1
§15.407 §2.1091	RF Exposure	/	Compliant	Note 2

Remark:

1. The measurement uncertainty is not included in the test result.
2. NA = Not Applicable; NP = Not Performed
3. Note 1 – Test results inside test report;
4. Note 2 – Test results in other test report (MPE Report).
5. We tested all test mode and recorded worst case in report

Preliminary tests were performed in different data rate to find the worst radiated emission. The data rate shown in the table below is the worst-case rate with respect to the specific test item. Investigation has been done on all the possible configurations for searching the worst cases. The following table is a list of the test modes shown in this test report.

Test Items	Mode	Data Rate
Maximum Peak Conducted Output Power	802.11a	6 Mbps
Power Spectral Density	802.11ac20/ac40/ac80 802.11n HT20/40/ax20/ax40/ax80	MCS0
6dB Bandwidth		
26dB Bandwidth		
Radiated Emission30M~1GHz& Radiated Emission 1GHz~10 <sup>th</sup> Harmonic		
Band Edge	802.11a	6 Mbps
	802.11ac20/ac40/ac80 802.11n HT20/40/ax20/ax40/ax80	MCS0

### 3.6. Equipments Used during the Test

Test Equipment	Manufacturer	Model No.	Serial No.	Calibration Date	Calibration Due Date
LISN	CYBERTEK	EM5040A	E1850400105	2023/07/13	2024/07/12
LISN	R&S	ESH2-Z5	893606/008	2023/07/13	2024/07/12
EMI Test Receiver	R&S	ESPI3	101841-cd	2023/07/13	2024/07/12
EMI Test Receiver	R&S	ESCI7	101102	2022/09/09	2023/09/08
Spectrum Analyzer	Agilent	N9020A	MY48010425	2022/09/09	2023/09/08
Spectrum Analyzer	R&S	FSV40	100019	2023/07/13	2024/07/12
Vector Signal generator	Agilent	N5181A	MY49060502	2023/07/13	2024/07/12
Signal generator	Agilent	N5182A	3610AO1069	2022/09/09	2023/09/08
Climate Chamber	ESPEC	EL-10KA	A20120523	2022/09/09	2023/09/08
Controller	EM Electronics	Controller EM 1000	N/A	N/A	N/A
Horn Antenna	Schwarzbeck	BBHA 9120D	01622	2022/09/09	2023/09/08
Active Loop Antenna	Beijing Da Ze Technology Co.,Ltd.	ZN30900C	15006	2022/09/09	2023/09/08
Bilog Antenna	Schwarzbeck	VULB9163	000976	2023/07/13	2024/07/12
Broadband Horn Antenna	SCHWARZBECK	BBHA 9170	791	2022/09/09	2023/09/08
Amplifier	Schwarzbeck	BBV 9743	#202	2023/07/13	2024/07/12
Amplifier	Schwarzbeck	BBV9179	9719-025	2023/07/13	2024/07/12
Amplifier	EMCI	EMC051845B	980355	2023/07/13	2024/07/12
Temperature/Humidity Meter	Gangxing	CTH-608	02	2023/07/13	2024/07/12
High-Pass Filter	K&L	9SH10-2700/X12750-O/O	KL142031	2023/07/13	2024/07/12
High-Pass Filter	K&L	41H10-1375/U12750-O/O	KL142032	2023/07/13	2024/07/12
RF Cable(below 1GHz)	HUBER+SUHNER	RG214	RE01	2023/07/13	2024/07/12
RF Cable(above 1GHz)	HUBER+SUHNER	RG214	RE02	2023/07/13	2024/07/12
Data acquisition card	Agilent	U2531A	TW53323507	2023/07/13	2024/07/12
Power Sensor	Agilent	U2021XA	MY5365004	2023/07/13	2024/07/12
Test Control Unit	Tonscend	JS0806-1	178060067	2023/07/13	2024/07/12
Automated filter bank	Tonscend	JS0806-F	19F8060177	2023/07/13	2024/07/12
EMI Test Software	Tonscend	JS1120-1	Ver 2.6.8.0518	/	/
EMI Test Software	Tonscend	JS1120-3	Ver 2.5.77.0418	/	/
EMI Test Software	Tonscend	JS32-CE	Ver 2.5	/	/
EMI Test Software	Tonscend	JS32-RE	Ver 2.5.1.8	/	/

Note: The Cal.Interval was one year.

## 4. TEST CONDITIONS AND RESULTS

### 4.1. AC Power Conducted Emission

#### TEST CONFIGURATION

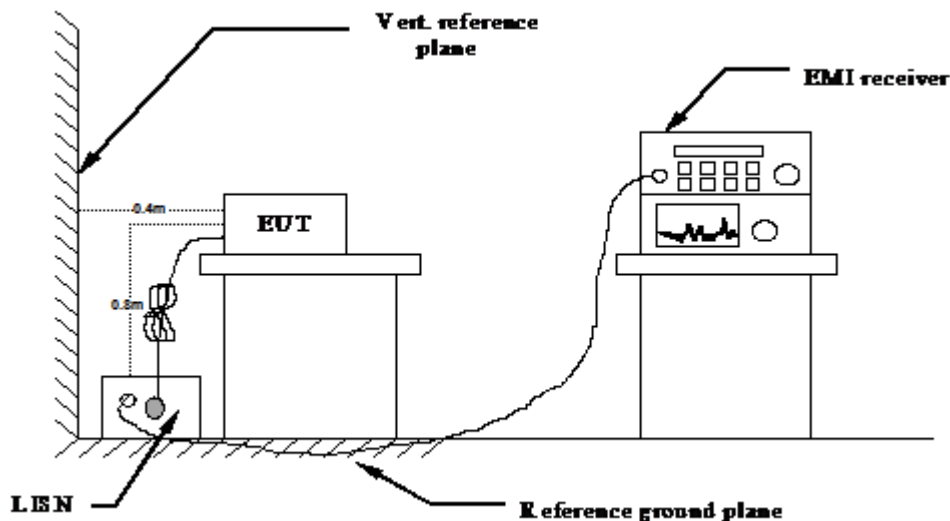

#### TEST PROCEDURE

- 1 The equipment was set up as per the test configuration to simulate typical actual usage per the user's manual. The EUT is a tabletop system, a wooden table with a height of 0.8 meters is used and is placed on the ground plane as per ANSI C63.10-2020.
- 2 Support equipment, if needed, was placed as per ANSI C63.10-2020
- 3 All I/O cables were positioned to simulate typical actual usage as per ANSI C63.10-2020
- 4 The EUT received DC 24.0V power, the adapter received AC120V/60Hz or AC 240V/60Hz power through a Line Impedance Stabilization Network (LISN) which supplied power source and was grounded to the ground plane.
- 5 All support equipments received AC power from a second LISN, if any.
- 6 The EUT test program was started. Emissions were measured on each current carrying line of the EUT using a spectrum Analyzer / Receiver connected to the LISN powering the EUT. The LISN has two monitoring points: Line 1 (Hot Side) and Line 2 (Neutral Side). Two scans were taken: one with Line 1 connected to Analyzer / Receiver and Line 2 connected to a 50 ohm load; the second scan had Line 1 connected to a 50 ohm load and Line 2 connected to the Analyzer / Receiver.
- 7 Analyzer / Receiver scanned from 150 KHz to 30MHz for emissions in each of the test modes.
- 8 During the above scans, the emissions were maximized by cable manipulation.

#### AC Power Conducted Emission Limit

For intentional device, according to § 15.207(a) AC Power Conducted Emission Limits is as following :

Frequency range (MHz)	Limit (dBuV)	
	Quasi-peak	Average
0.15-0.5	66 to 56*	56 to 46*
0.5-5	56	46
5-30	60	50

\* Decreases with the logarithm of the frequency.

#### TEST RESULTS

Remark: We measured Conducted Emission at all mode in AC 120V/60Hz, the worst case was recorded .

Temperature	25°C	Humidity	60%
Test Engineer	Evan Ouyang	Configurations	IEEE 802.11ac20 HCH

Version A:  
 Adapter: CYSE65-240250

Power supply:	AC 120V/60Hz	Polarization	L
---------------	--------------	--------------	---

Test Graph

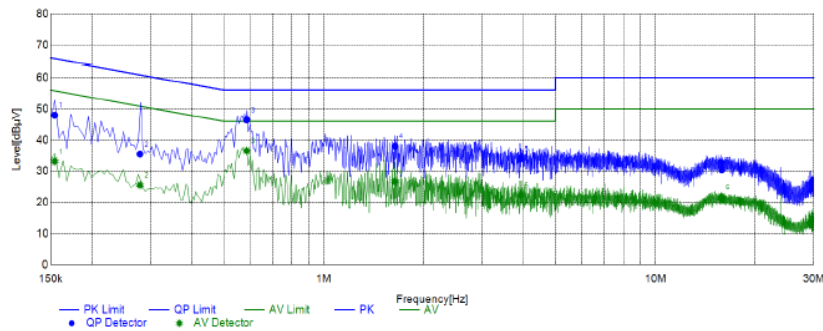

Final Data List

NO.	Frequency	QP	AVG.	Factor	QP	AVG.	QP	AVG.	QP	AVG.	Line	Remark
		Reading	Reading		Result	Result	Limit	Limit	Margin	Margin		
1	0.1542	38.35	23.61	9.60	47.95	33.21	65.77	55.77	17.82	22.56	L1	PASS
2	0.2792	26.10	16.13	9.44	35.54	25.57	60.84	50.84	25.30	25.27	L1	PASS
3	0.5852	36.85	26.91	9.66	46.51	36.57	56.00	46.00	9.49	9.43	L1	PASS
4	1.6407	28.72	17.39	9.37	38.09	26.76	56.00	46.00	17.91	19.24	L1	PASS
5	3.9156	24.61	12.94	9.41	34.02	22.35	56.00	46.00	21.98	23.65	L1	PASS
6	15.8552	21.27	12.56	9.18	30.45	21.74	60.00	50.00	29.55	28.26	L1	PASS

Note: 1. Result (dBµ A) = Reading (dBµ A) + Factor (dB).

2. Factor (dB) = Cable loss (dB) + LISN Factor (dB).

Power supply:	AC 120V/60Hz	Polarization	N
---------------	--------------	--------------	---

Test Graph

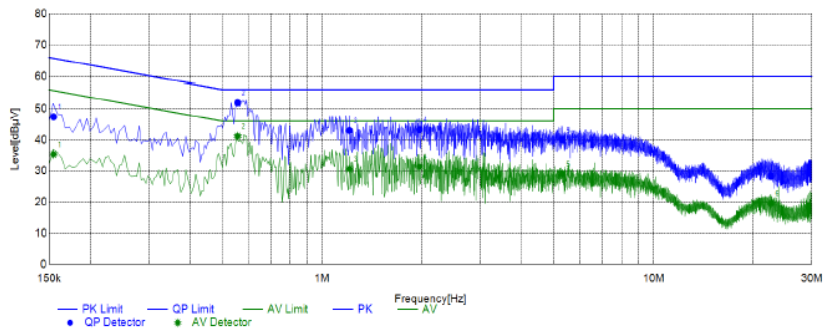

Final Data List

NO.	Frequency	QP	AVG.	Factor	QP	AVG.	QP	AVG.	QP	AVG.	Line	Remark
		Reading	Reading		Result	Result	Limit	Limit	Margin	Margin		
1	0.1547	37.77	25.74	9.61	47.38	35.35	65.74	55.74	18.36	20.39	N	PASS
2	0.5558	42.48	31.77	9.40	51.88	41.17	56.00	46.00	4.12	4.83	N	PASS
3	1.2088	33.65	21.29	9.38	43.03	30.67	56.00	46.00	12.97	15.33	N	PASS
4	1.9675	33.99	22.09	9.34	43.33	31.43	56.00	46.00	12.67	14.57	N	PASS
5	5.3082	30.66	19.80	9.33	39.99	29.13	60.00	50.00	20.01	20.87	N	PASS
6	22.6305	19.09	10.41	9.25	28.34	19.66	60.00	50.00	31.66	30.34	N	PASS

Note: 1. Result (dBµ A) = Reading (dBµ A) + Factor (dB).

2. Factor (dB) = Cable loss (dB) + LISN Factor (dB).

Adapter: SOY-2400250-332-A

Power supply:	AC 120V/60Hz	Polarization	L
---------------	--------------	--------------	---

Test Graph

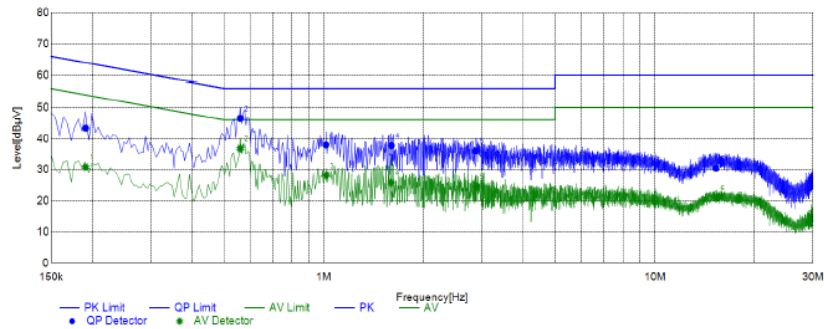

Final Data List												
NO.	Frequency	QP	AVG.	Factor	QP	AVG.	QP	AVG.	QP	AVG.	Line	Remark
		Reading	Reading		Result	Result	Limit	Limit	Margin	Margin		
1	0.1907	33.81	21.29	9.57	43.38	30.86	64.01	54.01	20.63	23.15	L1	PASS
2	0.5594	36.95	27.27	9.58	46.53	36.85	56.00	46.00	9.47	9.15	L1	PASS
3	1.0142	28.60	18.80	9.38	37.98	28.18	56.00	46.00	18.02	17.82	L1	PASS
4	1.5977	28.40	16.47	9.38	37.78	25.85	56.00	46.00	18.22	20.15	L1	PASS
5	2.8795	26.69	15.30	9.35	36.04	24.65	56.00	46.00	19.96	21.35	L1	PASS
6	15.3147	21.29	11.92	9.16	30.45	21.08	60.00	50.00	29.55	28.92	L1	PASS

Note: 1. Result (dBu A) = Reading (dBu A) + Factor (dB).

2. Factor (dB) = Cable loss (dB) + LISN Factor (dB).

Power supply:	AC 120V/60Hz	Polarization	N
---------------	--------------	--------------	---

Test Graph

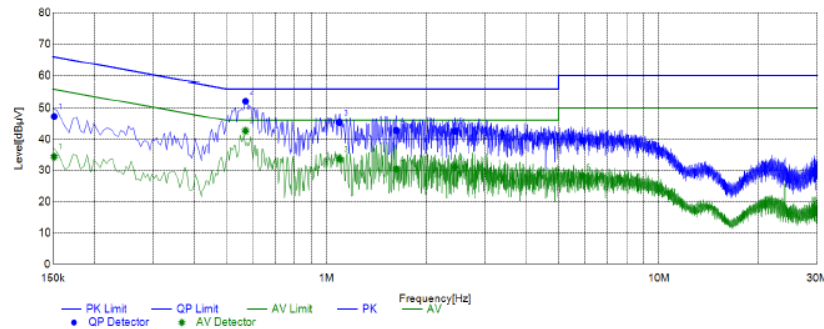

Final Data List												
NO.	Frequency	QP	AVG.	Factor	QP	AVG.	QP	AVG.	QP	AVG.	Line	Remark
		Reading	Reading		Result	Result	Limit	Limit	Margin	Margin		
1	0.1515	37.64	24.79	9.61	47.25	34.40	65.92	55.92	18.67	21.52	N	PASS
2	0.5705	42.74	33.31	9.40	52.14	42.71	56.00	46.00	3.86	3.29	N	PASS
3	1.0945	35.98	24.31	9.37	45.35	33.68	56.00	46.00	10.65	12.32	N	PASS
4	1.6221	33.49	21.07	9.36	42.85	30.43	56.00	46.00	13.15	15.57	N	PASS
5	2.4335	33.28	21.78	9.34	42.62	31.12	56.00	46.00	13.38	14.88	N	PASS
6	5.8820	30.19	18.87	9.34	39.53	28.21	60.00	50.00	20.47	21.79	N	PASS

Note: 1. Result (dBu A) = Reading (dBu A) + Factor (dB).

2. Factor (dB) = Cable loss (dB) + LISN Factor (dB).

Adapter: AD65CM249250A

Power supply:	AC 120V/60Hz	Polarization	L
---------------	--------------	--------------	---

Test Graph

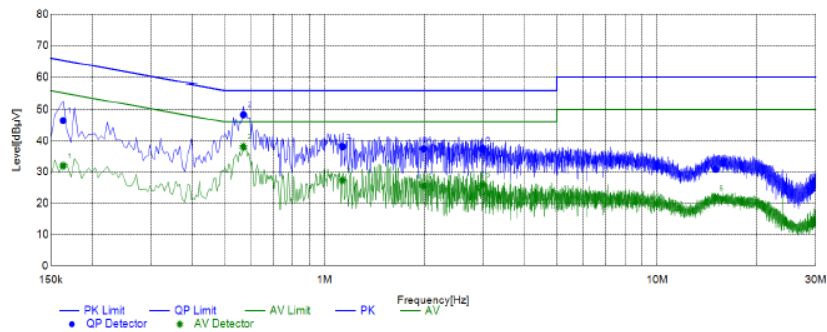

Final Data List												
NO.	Frequency	QP	AVG.	Factor	QP	AVG.	QP	AVG.	QP	AVG.	Line	Remark
		Reading	Reading		Result	Result	Limit	Limit	Margin	Margin		
1	0.1634	36.86	22.40	9.60	46.46	32.00	65.29	55.29	18.83	23.29	L1	PASS
2	0.5699	38.75	28.48	9.61	48.36	38.09	56.00	46.00	7.64	7.91	L1	PASS
3	1.1308	28.73	17.93	9.39	38.12	27.32	56.00	46.00	17.88	18.68	L1	PASS
4	1.9895	28.07	16.25	9.35	37.42	25.60	56.00	46.00	18.58	20.40	L1	PASS
5	2.9840	28.11	16.63	9.35	37.46	25.98	56.00	46.00	18.54	20.02	L1	PASS
6	14.9886	21.83	12.62	9.16	30.99	21.78	60.00	50.00	29.01	28.22	L1	PASS

Note: 1. Result (dBµ A) = Reading (dBµ A) + Factor (dB).

2. Factor (dB) = Cable loss (dB) + LISN Factor (dB).

Power supply:	AC 120V/60Hz	Polarization	N
---------------	--------------	--------------	---

Test Graph

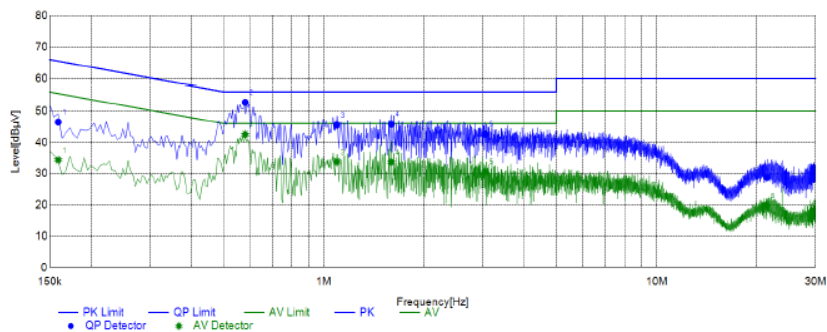

Final Data List												
NO.	Frequency	QP	AVG.	Factor	QP	AVG.	QP	AVG.	QP	AVG.	Line	Remark
		Reading	Reading		Result	Result	Limit	Limit	Margin	Margin		
1	0.1592	36.89	24.76	9.60	46.49	34.36	65.51	55.51	19.02	21.15	N	PASS
2	0.5796	43.36	33.13	9.40	52.76	42.53	56.00	46.00	3.24	3.47	N	PASS
3	1.0938	36.15	24.43	9.37	45.52	33.80	56.00	46.00	10.48	12.20	N	PASS
4	1.5938	36.43	24.31	9.36	45.79	33.67	56.00	46.00	10.21	12.33	N	PASS
5	3.0537	33.34	21.34	9.33	42.67	30.67	56.00	46.00	13.33	15.33	N	PASS
6	21.4419	19.50	10.56	9.24	28.74	19.80	60.00	50.00	31.26	30.20	N	PASS

Note: 1. Result (dBµ A) = Reading (dBµ A) + Factor (dB).

2. Factor (dB) = Cable loss (dB) + LISN Factor (dB).



Adapter: ADS-65HI-19A-1 24060E

Power supply:	AC 120V/60Hz	Polarization	L
---------------	--------------	--------------	---

Test Graph

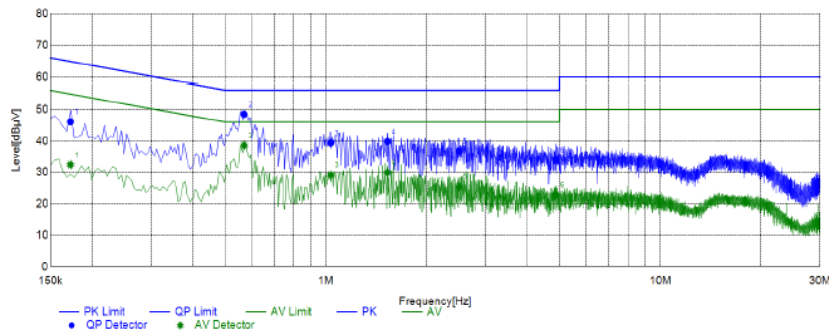

Final Data List

NO.	Frequency	QP	AVG.	Factor	QP	AVG.	QP	AVG.	QP	AVG.	Line	Remark
		Reading	Reading		Result	Result	Limit	Limit	Margin	Margin		
1	0.1724	36.51	22.83	9.60	46.11	32.43	64.85	54.85	18.74	22.42	L1	PASS
2	0.5696	38.85	28.99	9.61	48.46	38.60	56.00	46.00	7.54	7.40	L1	PASS
3	1.0330	29.95	19.88	9.38	39.33	29.26	56.00	46.00	16.67	16.74	L1	PASS
4	1.5264	30.41	20.58	9.38	39.79	29.96	56.00	46.00	16.21	16.04	L1	PASS
5	2.4999	27.43	16.16	9.36	36.79	25.52	56.00	46.00	19.21	20.48	L1	PASS
6	4.8736	24.63	13.54	9.36	33.99	22.90	56.00	46.00	22.01	23.10	L1	PASS

Note: 1. Result (dBµ A) = Reading (dBµ A) + Factor (dB).

2. Factor (dB) = Cable loss (dB) + LISN Factor (dB).

Power supply:	AC 120V/60Hz	Polarization	N
---------------	--------------	--------------	---

Test Graph

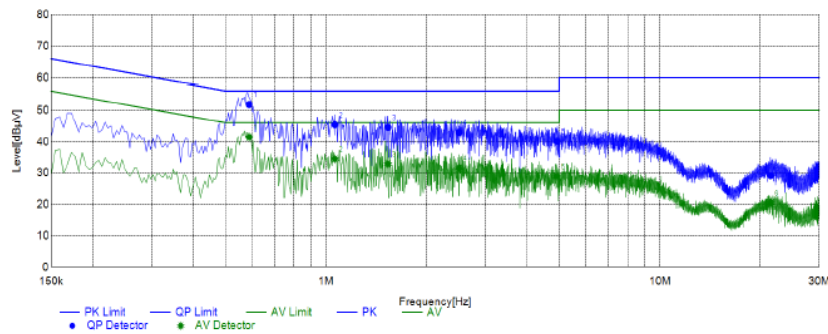

Final Data List

NO.	Frequency	QP	AVG.	Factor	QP	AVG.	QP	AVG.	QP	AVG.	Line	Remark
		Reading	Reading		Result	Result	Limit	Limit	Margin	Margin		
1	0.5880	42.41	32.01	9.40	51.81	41.41	56.00	46.00	4.19	4.59	N	PASS
2	1.0625	36.01	25.13	9.37	45.38	34.50	56.00	46.00	10.62	11.50	N	PASS
3	1.5312	35.19	23.51	9.36	44.55	32.87	56.00	46.00	11.45	13.13	N	PASS
4	2.5000	33.63	22.26	9.34	42.97	31.60	56.00	46.00	13.03	14.40	N	PASS
5	4.9213	30.80	19.61	9.33	40.13	28.94	56.00	46.00	15.87	17.06	N	PASS
6	21.4666	19.90	11.19	9.24	29.14	20.43	60.00	50.00	30.86	29.57	N	PASS

Note: 1. Result (dBµ A) = Reading (dBµ A) + Factor (dB).

2. Factor (dB) = Cable loss (dB) + LISN Factor (dB).

Version B:  
Adapter: CYSE65-240250

Power supply:	AC 120V/60Hz	Polarization	L
---------------	--------------	--------------	---

Test Graph

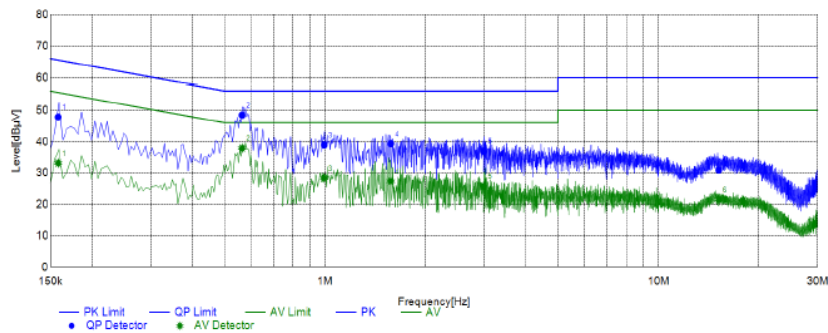

Final Data List												
NO.	Frequency	QP	AVG.	Factor	QP	AVG.	QP	AVG.	QP	AVG.	Line	Remark
		Reading	Reading		Result	Result	Limit	Limit	Margin	Margin		
1	0.1583	38.21	23.55	9.60	47.81	33.15	65.55	55.55	17.74	22.40	L1	PASS
2	0.5640	38.86	28.34	9.59	48.45	37.93	56.00	46.00	7.55	8.07	L1	PASS
3	0.9932	29.56	18.99	9.38	38.94	28.37	56.00	46.00	17.06	17.63	L1	PASS
4	1.5747	29.96	18.02	9.38	39.34	27.40	56.00	46.00	16.66	18.60	L1	PASS
5	2.9880	27.66	16.50	9.35	37.01	25.85	56.00	46.00	18.99	20.15	L1	PASS
6	15.1666	21.88	12.45	9.16	31.04	21.61	60.00	50.00	28.96	28.39	L1	PASS

Note: 1. Result (dBµ A) = Reading (dBµ A) + Factor (dB).

2. Factor (dB) = Cable loss (dB) + LISN Factor (dB).

Power supply:	AC 120V/60Hz	Polarization	N
---------------	--------------	--------------	---

Test Graph

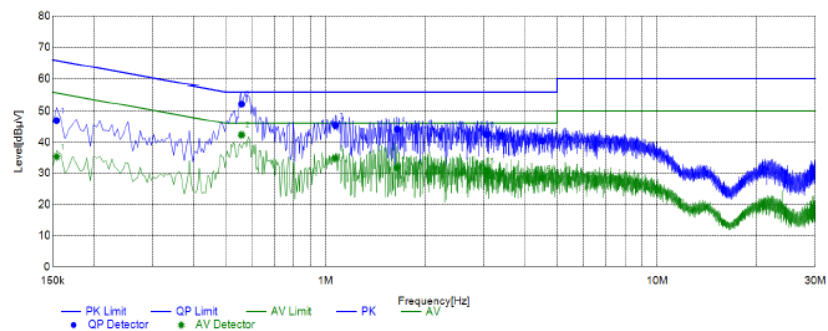

Final Data List												
NO.	Frequency	QP	AVG.	Factor	QP	AVG.	QP	AVG.	QP	AVG.	Line	Remark
		Reading	Reading		Result	Result	Limit	Limit	Margin	Margin		
1	0.1542	37.30	25.70	9.61	46.91	35.31	65.77	55.77	18.86	20.46	N	PASS
2	0.5577	42.79	32.95	9.40	52.19	42.35	56.00	46.00	3.81	3.65	N	PASS
3	1.0696	35.99	25.48	9.37	45.36	34.85	56.00	46.00	10.64	11.15	N	PASS
4	1.6441	34.76	22.50	9.35	44.11	31.85	56.00	46.00	11.89	14.15	N	PASS
5	3.0573	33.09	21.42	9.33	42.42	30.75	56.00	46.00	13.58	15.25	N	PASS
6	4.5054	31.04	19.17	9.37	40.41	28.54	56.00	46.00	15.59	17.46	N	PASS

Note: 1. Result (dBµ A) = Reading (dBµ A) + Factor (dB).

2. Factor (dB) = Cable loss (dB) + LISN Factor (dB).

Adapter: SOY-2400250-332-A

Power supply:	AC 120V/60Hz	Polarization	L
---------------	--------------	--------------	---

Test Graph

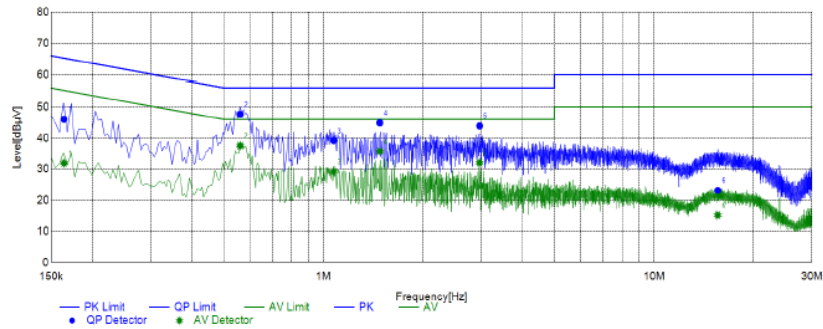

Final Data List												
NO.	Frequency	QP	AVG.	Factor	QP	AVG.	QP	AVG.	QP	AVG.	Line	Remark
		Reading	Reading		Result	Result	Limit	Limit	Margin	Margin		
1	0.1642	36.43	22.35	9.60	46.03	31.95	65.25	55.25	19.22	23.30	L1	PASS
2	0.5600	38.07	27.99	9.58	47.65	37.57	56.00	46.00	8.35	8.43	L1	PASS
3	1.0725	29.79	19.88	9.39	39.18	29.27	56.00	46.00	16.82	16.73	L1	PASS
4	1.4807	35.51	26.34	9.38	44.89	35.72	56.00	46.00	11.11	10.28	L1	PASS
5	2.9636	34.57	22.71	9.35	43.92	32.06	56.00	46.00	12.08	13.94	L1	PASS
6	15.5827	14.06	6.08	9.17	23.23	15.25	60.00	50.00	36.77	34.75	L1	PASS

Note: 1. Result (dBµ A) = Reading (dBµ A) + Factor (dB).

2. Factor (dB) = Cable loss (dB) + LISN Factor (dB).

Power supply:	AC 120V/60Hz	Polarization	N
---------------	--------------	--------------	---

Test Graph

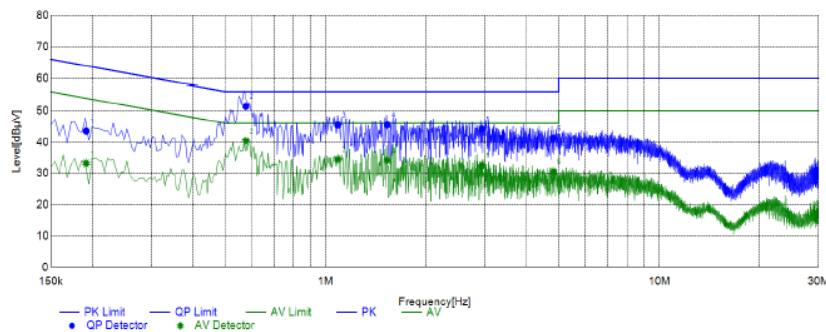

Final Data List												
NO.	Frequency	QP	AVG.	Factor	QP	AVG.	QP	AVG.	QP	AVG.	Line	Remark
		Reading	Reading		Result	Result	Limit	Limit	Margin	Margin		
1	0.1914	33.94	23.58	9.60	43.54	33.18	63.98	53.98	20.44	20.80	N	PASS
2	0.5760	42.00	30.97	9.40	51.40	40.37	56.00	46.00	4.60	5.63	N	PASS
3	1.0865	36.08	25.11	9.37	45.45	34.48	56.00	46.00	10.55	11.52	N	PASS
4	1.5301	36.14	24.78	9.36	45.50	34.14	56.00	46.00	10.50	11.86	N	PASS
5	2.9396	34.87	23.18	9.33	44.20	32.51	56.00	46.00	11.80	13.49	N	PASS
6	4.8081	31.96	21.25	9.34	41.30	30.59	56.00	46.00	14.70	15.41	N	PASS

Note: 1. Result (dBµ A) = Reading (dBµ A) + Factor (dB).

2. Factor (dB) = Cable loss (dB) + LISN Factor (dB).

Adapter: AD65CM249250A

Power supply:	AC 120V/60Hz	Polarization	L
---------------	--------------	--------------	---

Test Graph

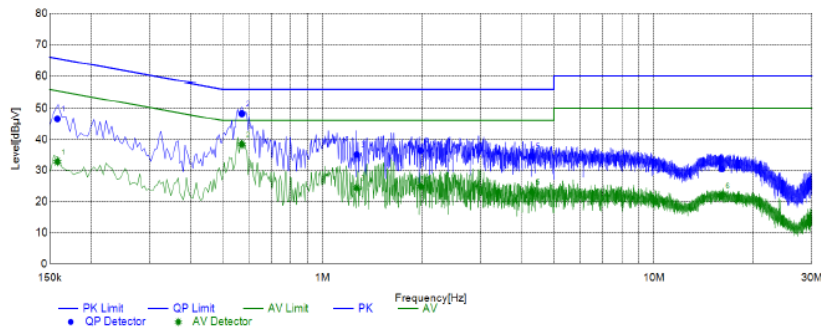

Final Data List												
NO.	Frequency	QP	AVG.	Factor	QP	AVG.	QP	AVG.	QP	AVG.	Line	Remark
		Reading	Reading		Result	Result	Limit	Limit	Margin	Margin		
1	0.1583	36.98	23.22	9.60	46.58	32.82	65.55	55.55	18.97	22.73	L1	PASS
2	0.5707	38.67	28.81	9.61	48.28	38.42	56.00	46.00	7.72	7.58	L1	PASS
3	1.2678	25.74	15.00	9.39	35.13	24.39	56.00	46.00	20.87	21.61	L1	PASS
4	1.9772	27.05	15.59	9.35	36.40	24.94	56.00	46.00	19.60	21.06	L1	PASS
5	4.2826	25.26	13.78	9.40	34.66	23.18	56.00	46.00	21.34	22.82	L1	PASS
6	16.0495	21.40	12.84	9.16	30.56	22.00	60.00	50.00	29.44	28.00	L1	PASS

Note: 1. Result (dBµ A) = Reading (dBµ A) + Factor (dB).

2. Factor (dB) = Cable loss (dB) + LISN Factor (dB).

Power supply:	AC 120V/60Hz	Polarization	N
---------------	--------------	--------------	---

Test Graph

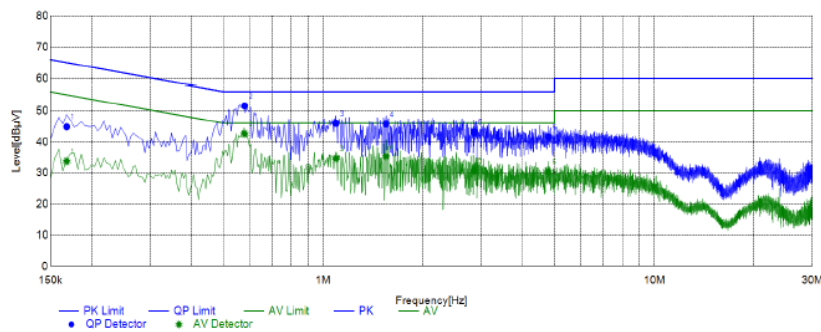

Final Data List												
NO.	Frequency	QP	AVG.	Factor	QP	AVG.	QP	AVG.	QP	AVG.	Line	Remark
		Reading	Reading		Result	Result	Limit	Limit	Margin	Margin		
1	0.1679	35.26	24.13	9.59	44.85	33.72	65.06	55.06	20.21	21.34	N	PASS
2	0.5785	42.14	33.22	9.40	51.54	42.62	56.00	46.00	4.46	3.38	N	PASS
3	1.0938	36.60	25.34	9.37	45.97	34.71	56.00	46.00	10.03	11.29	N	PASS
4	1.5472	36.40	25.97	9.36	45.76	35.33	56.00	46.00	10.24	10.67	N	PASS
5	2.8532	33.85	21.54	9.33	43.18	30.87	56.00	46.00	12.82	15.13	N	PASS
6	4.7851	32.26	21.05	9.34	41.60	30.39	56.00	46.00	14.40	15.61	N	PASS

Note: 1. Result (dBµ A) = Reading (dBµ A) + Factor (dB).

2. Factor (dB) = Cable loss (dB) + LISN Factor (dB).

Adapter: ADS-65HI-19A-1 24060E

Power supply:	AC 120V/60Hz	Polarization	L
---------------	--------------	--------------	---

Test Graph

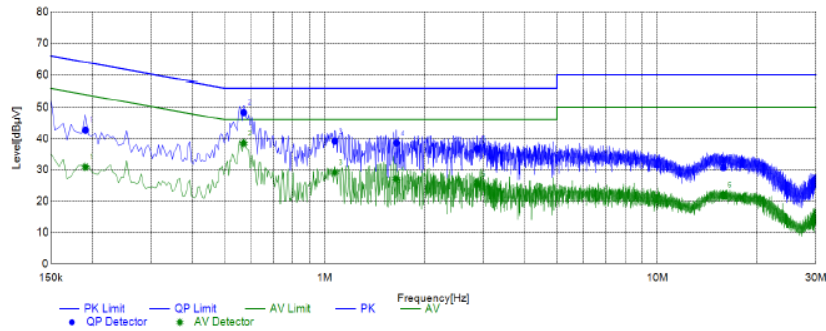

Final Data List												
NO.	Frequency	QP	AVG.	Factor	QP	AVG.	QP	AVG.	QP	AVG.	Line	Remark
		Reading	Reading		Result	Result	Limit	Limit	Margin	Margin		
1	0.1908	33.16	21.37	9.57	42.73	30.94	64.00	54.00	21.27	23.06	L1	PASS
2	0.5709	38.72	28.86	9.61	48.33	38.47	56.00	46.00	7.67	7.53	L1	PASS
3	1.0719	29.79	19.86	9.39	39.18	29.25	56.00	46.00	16.82	16.75	L1	PASS
4	1.6423	29.23	17.78	9.37	38.60	27.15	56.00	46.00	17.40	18.85	L1	PASS
5	2.8764	27.45	16.15	9.35	36.80	25.50	56.00	46.00	19.20	20.50	L1	PASS
6	15.8120	21.59	12.97	9.17	30.76	22.14	60.00	50.00	29.24	27.86	L1	PASS

Note: 1. Result (dBµ A) = Reading (dBµ A) + Factor (dB).

2. Factor (dB) = Cable loss (dB) + LISN Factor (dB).

Power supply:	AC 120V/60Hz	Polarization	N
---------------	--------------	--------------	---

Test Graph

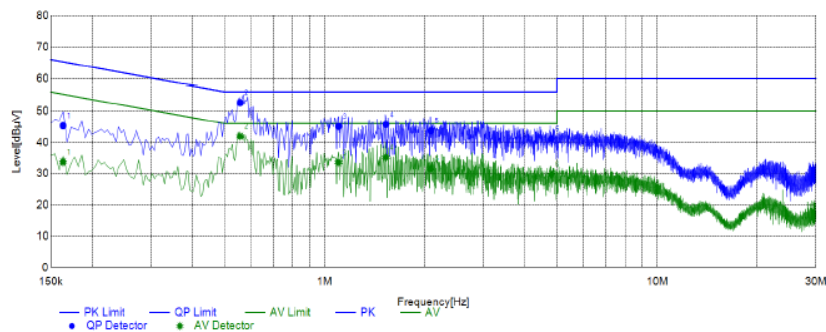

Final Data List												
NO.	Frequency	QP	AVG.	Factor	QP	AVG.	QP	AVG.	QP	AVG.	Line	Remark
		Reading	Reading		Result	Result	Limit	Limit	Margin	Margin		
1	0.1633	35.70	24.08	9.60	45.30	33.68	65.29	55.29	19.99	21.61	N	PASS
2	0.5571	43.24	32.53	9.40	52.64	41.93	56.00	46.00	3.36	4.07	N	PASS
3	1.1014	35.68	24.20	9.37	45.05	33.57	56.00	46.00	10.95	12.43	N	PASS
4	1.5261	36.38	25.89	9.36	45.74	35.25	56.00	46.00	10.26	10.75	N	PASS
5	2.0832	34.37	22.22	9.35	43.72	31.57	56.00	46.00	12.28	14.43	N	PASS
6	4.8063	31.86	20.54	9.34	41.20	29.88	56.00	46.00	14.80	16.12	N	PASS

Note: 1. Result (dBµ A) = Reading (dBµ A) + Factor (dB).

2. Factor (dB) = Cable loss (dB) + LISN Factor (dB).

Version C:  
Adapter: CYSE65-240250

Power supply:	AC 120V/60Hz	Polarization	L
---------------	--------------	--------------	---

Test Graph

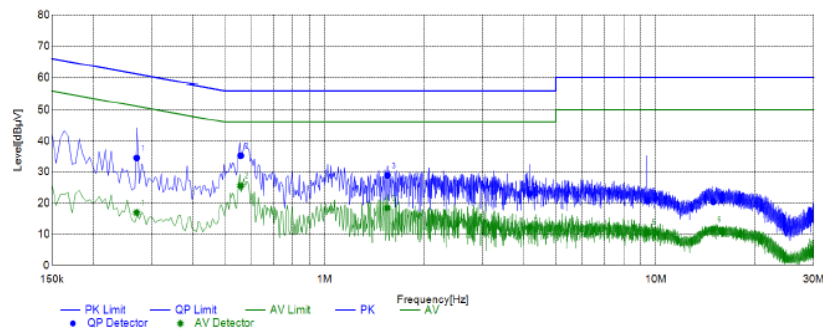

Final Data List												
NO.	Frequency	QP	AVG.	Factor	QP	AVG.	QP	AVG.	QP	AVG.	Line	Remark
		Reading	Reading		Result	Result	Limit	Limit	Margin	Margin		
1	0.2706	34.42	16.82	0.10	34.52	16.92	61.10	51.10	26.58	34.18	L1	PASS
2	0.5576	35.10	25.46	0.13	35.23	25.59	56.00	46.00	20.77	20.41	L1	PASS
3	1.5484	28.71	18.22	0.22	28.93	18.44	56.00	46.00	27.07	27.56	L1	PASS
4	4.1680	22.79	12.07	0.27	23.06	12.34	56.00	46.00	32.94	33.66	L1	PASS
5	9.4437	20.66	10.54	0.14	20.80	10.68	60.00	50.00	39.20	39.32	L1	PASS
6	14.9365	20.79	11.89	-0.25	20.54	11.64	60.00	50.00	39.46	38.36	L1	PASS

Note: 1. Result (dBµ A) = Reading (dBµ A) + Factor (dB).

2. Factor (dB) = Cable loss (dB) + LISN Factor (dB).

Power supply:	AC 120V/60Hz	Polarization	N
---------------	--------------	--------------	---

Test Graph

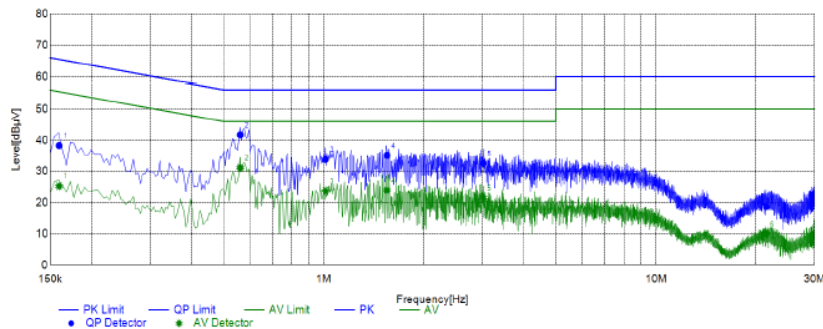

Final Data List												
NO.	Frequency	QP	AVG.	Factor	QP	AVG.	QP	AVG.	QP	AVG.	Line	Remark
		Reading	Reading		Result	Result	Limit	Limit	Margin	Margin		
1	0.1596	38.25	25.30	0.04	38.29	25.34	65.49	55.49	27.20	30.15	N	PASS
2	0.5605	41.60	31.09	0.12	41.72	31.21	56.00	46.00	14.28	14.79	N	PASS
3	1.0116	33.73	23.65	0.13	33.86	23.78	56.00	46.00	22.14	22.22	N	PASS
4	1.5494	34.95	23.75	0.21	35.16	23.96	56.00	46.00	20.84	22.04	N	PASS
5	3.0226	32.32	21.34	0.27	32.59	21.61	56.00	46.00	23.41	24.39	N	PASS
6	21.4720	19.09	10.40	-0.33	18.76	10.07	60.00	50.00	41.24	39.93	N	PASS

Note: 1. Result (dBµ A) = Reading (dBµ A) + Factor (dB).

2. Factor (dB) = Cable loss (dB) + LISN Factor (dB).

Adapter: SOY-2400250-332-A

Power supply:	AC 120V/60Hz	Polarization	L
---------------	--------------	--------------	---

Test Graph

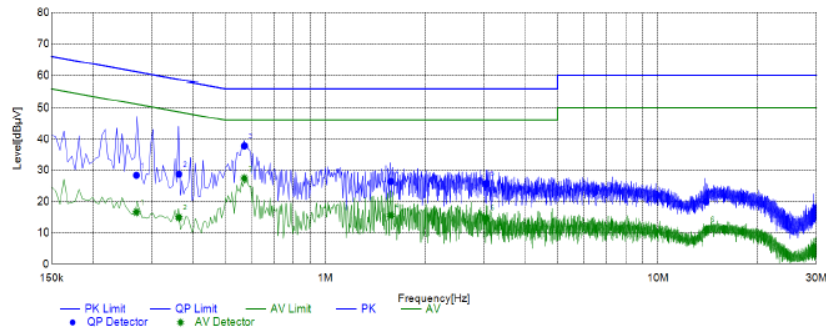

Final Data List												
NO.	Frequency	QP	AVG.	Factor	QP	AVG.	QP	AVG.	QP	AVG.	Line	Remark
		Reading	Reading		Result	Result	Limit	Limit	Margin	Margin		
1	0.2702	28.26	16.44	0.10	28.36	16.54	61.11	51.11	32.75	34.57	L1	PASS
2	0.3625	28.64	14.84	0.11	28.75	14.95	58.67	48.67	29.92	33.72	L1	PASS
3	0.5706	37.67	27.28	0.13	37.80	27.41	56.00	46.00	18.20	18.59	L1	PASS
4	1.5750	26.22	15.38	0.22	26.44	15.60	56.00	46.00	29.56	30.40	L1	PASS
5	3.0527	25.47	14.44	0.28	25.75	14.72	56.00	46.00	30.25	31.28	L1	PASS
6	13.9941	20.15	11.23	-0.18	19.97	11.05	60.00	50.00	40.03	38.95	L1	PASS

Note: 1. Result (dBµ A) = Reading (dBµ A) + Factor (dB).  
 2. Factor (dB) = Cable loss (dB) + LISN Factor (dB).

Power supply:	AC 120V/60Hz	Polarization	N
---------------	--------------	--------------	---

Test Graph

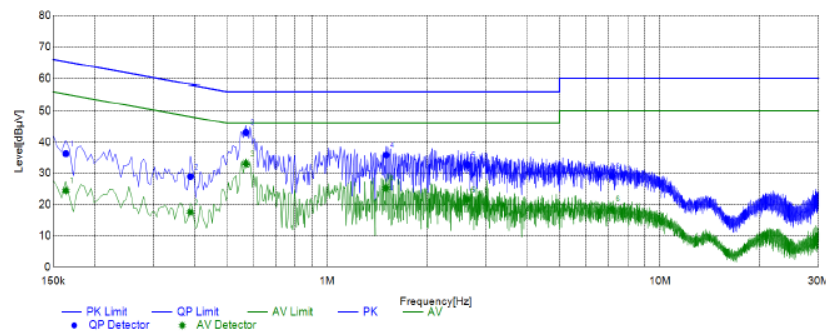

Final Data List												
NO.	Frequency	QP	AVG.	Factor	QP	AVG.	QP	AVG.	QP	AVG.	Line	Remark
		Reading	Reading		Result	Result	Limit	Limit	Margin	Margin		
1	0.1639	36.27	24.40	0.05	36.32	24.45	65.26	55.26	28.94	30.81	N	PASS
2	0.3878	28.84	17.46	0.10	28.94	17.56	58.11	48.11	29.17	30.55	N	PASS
3	0.5702	42.96	32.97	0.12	43.08	33.09	56.00	46.00	12.92	12.91	N	PASS
4	1.5054	35.61	25.12	0.20	35.81	25.32	56.00	46.00	20.19	20.68	N	PASS
5	2.6394	32.39	21.35	0.28	32.67	21.63	56.00	46.00	23.33	24.37	N	PASS
6	7.1770	28.97	18.40	0.20	29.17	18.60	60.00	50.00	30.83	31.40	N	PASS

Note: 1. Result (dBµ A) = Reading (dBµ A) + Factor (dB).  
 2. Factor (dB) = Cable loss (dB) + LISN Factor (dB).

Adapter: AD65CM249250A

Power supply:	AC 120V/60Hz	Polarization	L
---------------	--------------	--------------	---

Test Graph

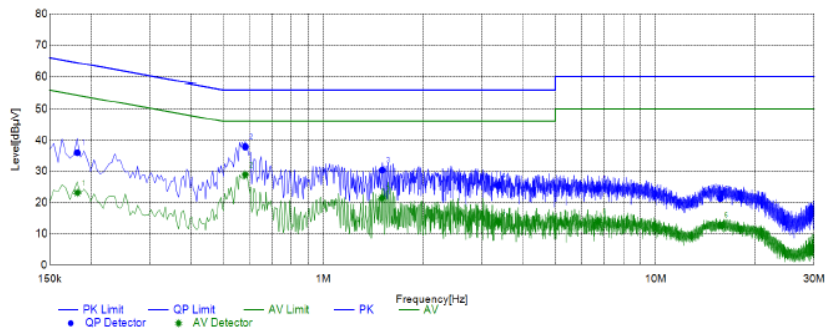

Final Data List												
NO.	Frequency	QP	AVG.	Factor	QP	AVG.	QP	AVG.	QP	AVG.	Line	Remark
		Reading	Reading		Result	Result	Limit	Limit	Margin	Margin		
1	0.1818	35.83	23.05	0.13	35.96	23.18	64.40	54.40	28.44	31.22	L1	PASS
2	0.5817	37.75	28.83	0.13	37.88	28.96	56.00	46.00	18.12	17.04	L1	PASS
3	1.5045	30.18	21.24	0.21	30.39	21.45	56.00	46.00	25.61	24.55	L1	PASS
4	3.3593	25.18	13.64	0.28	25.46	13.92	56.00	46.00	30.54	32.08	L1	PASS
5	6.7304	24.19	13.84	0.22	24.41	14.06	60.00	50.00	35.59	35.94	L1	PASS
6	15.6749	21.66	13.20	-0.30	21.36	12.90	60.00	50.00	38.64	37.10	L1	PASS

Note: 1. Result (dBµ A) = Reading (dBµ A) + Factor (dB).

2. Factor (dB) = Cable loss (dB) + LISN Factor (dB).

Power supply:	AC 120V/60Hz	Polarization	N
---------------	--------------	--------------	---

Test Graph

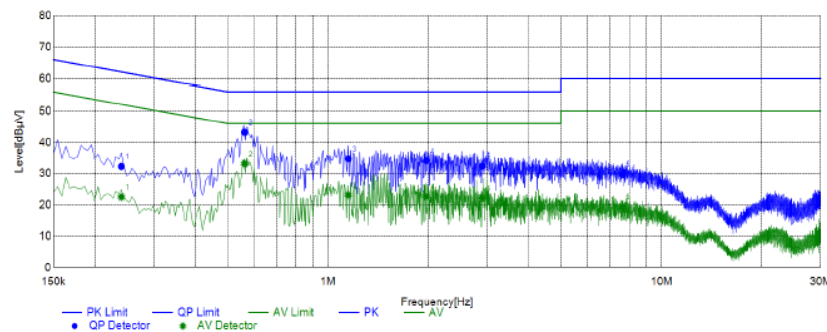

Final Data List												
NO.	Frequency	QP	AVG.	Factor	QP	AVG.	QP	AVG.	QP	AVG.	Line	Remark
		Reading	Reading		Result	Result	Limit	Limit	Margin	Margin		
1	0.2396	32.23	22.47	0.09	32.32	22.56	62.11	52.11	29.79	29.55	N	PASS
2	0.5620	43.14	33.06	0.12	43.26	33.18	56.00	46.00	12.74	12.82	N	PASS
3	1.1502	34.59	23.02	0.16	34.75	23.18	56.00	46.00	21.25	22.82	N	PASS
4	1.9701	33.91	22.46	0.27	34.18	22.73	56.00	46.00	21.82	23.27	N	PASS
5	2.9028	32.14	21.91	0.28	32.42	22.19	56.00	46.00	23.58	23.81	N	PASS
6	7.6254	29.60	19.29	0.19	29.79	19.48	60.00	50.00	30.21	30.52	N	PASS

Note: 1. Result (dBµ A) = Reading (dBµ A) + Factor (dB).

2. Factor (dB) = Cable loss (dB) + LISN Factor (dB).



Adapter: ADS-65HI-19A-1 24060E

Power supply:	AC 120V/60Hz	Polarization	L
---------------	--------------	--------------	---

Test Graph

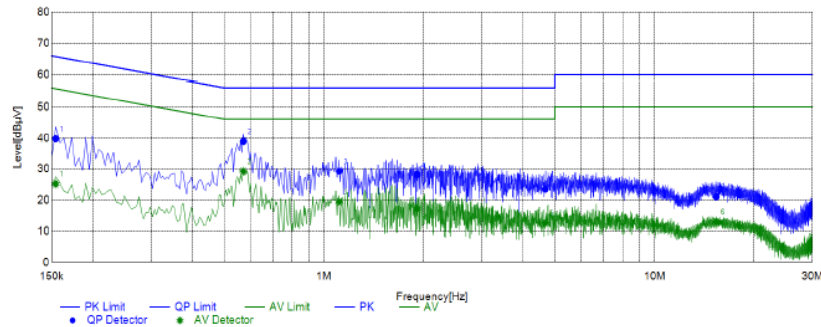

Final Data List												
NO.	Frequency	QP	AVG.	Factor	QP	AVG.	QP	AVG.	QP	AVG.	Line	Remark
		Reading	Reading		Result	Result	Limit	Limit	Margin	Margin		
1	0.1542	39.54	25.09	0.20	39.74	25.29	65.77	55.77	26.03	30.48	L1	PASS
2	0.5701	38.72	29.22	0.13	38.85	29.35	56.00	46.00	17.15	16.65	L1	PASS
3	1.1125	29.18	19.37	0.16	29.34	19.53	56.00	46.00	26.66	26.47	L1	PASS
4	1.9153	27.93	16.93	0.27	28.20	17.20	56.00	46.00	27.80	28.80	L1	PASS
5	4.6761	23.29	12.37	0.26	23.55	12.63	56.00	46.00	32.45	33.37	L1	PASS
6	15.3846	21.41	13.35	-0.28	21.13	13.07	60.00	50.00	38.87	36.93	L1	PASS

Note: 1. Result (dBµ A) = Reading (dBµ A) + Factor (dB).

2. Factor (dB) = Cable loss (dB) + LISN Factor (dB).

Power supply:	AC 120V/60Hz	Polarization	N
---------------	--------------	--------------	---

Test Graph

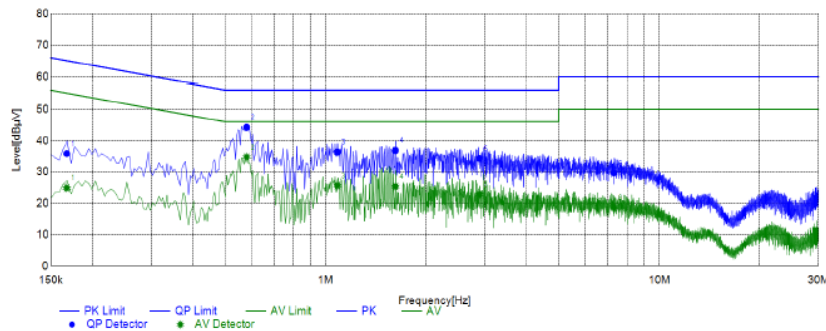

Final Data List												
NO.	Frequency	QP	AVG.	Factor	QP	AVG.	QP	AVG.	QP	AVG.	Line	Remark
		Reading	Reading		Result	Result	Limit	Limit	Margin	Margin		
1	0.1674	35.82	24.91	0.05	35.87	24.96	65.09	55.09	29.22	30.13	N	PASS
2	0.5791	44.14	34.66	0.12	44.26	34.78	56.00	46.00	11.74	11.22	N	PASS
3	1.0847	36.21	25.56	0.15	36.36	25.71	56.00	46.00	19.64	20.29	N	PASS
4	1.6185	36.69	25.18	0.22	36.91	25.40	56.00	46.00	19.09	20.60	N	PASS
5	2.8913	34.07	22.56	0.28	34.35	22.84	56.00	46.00	21.65	23.16	N	PASS
6	7.3093	29.51	18.55	0.21	29.72	18.76	60.00	50.00	30.28	31.24	N	PASS

Note: 1. Result (dBµ A) = Reading (dBµ A) + Factor (dB).

2. Factor (dB) = Cable loss (dB) + LISN Factor (dB).

## 4.2. Radiated Emission

### TEST CONFIGURATION

Frequency range 9 KHz – 30MHz

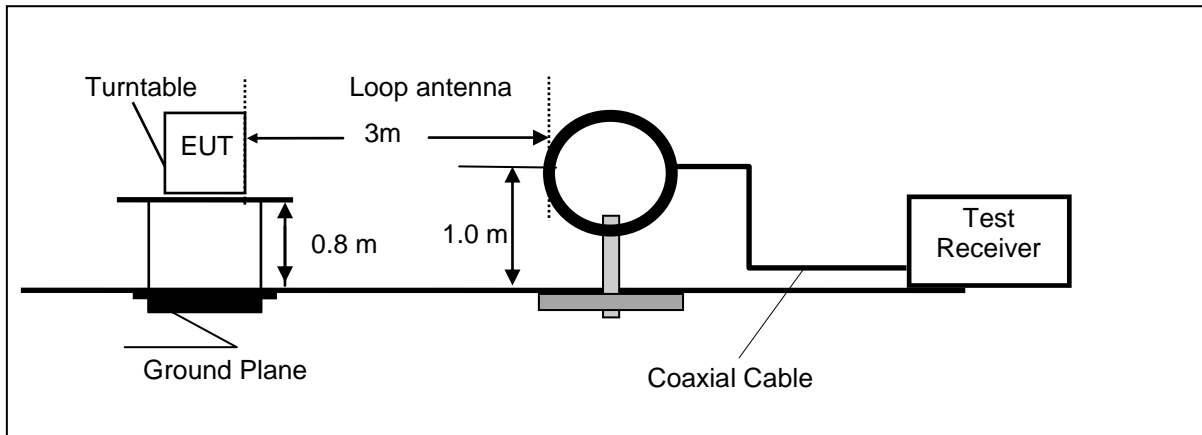

Frequency range 30MHz – 1000MHz

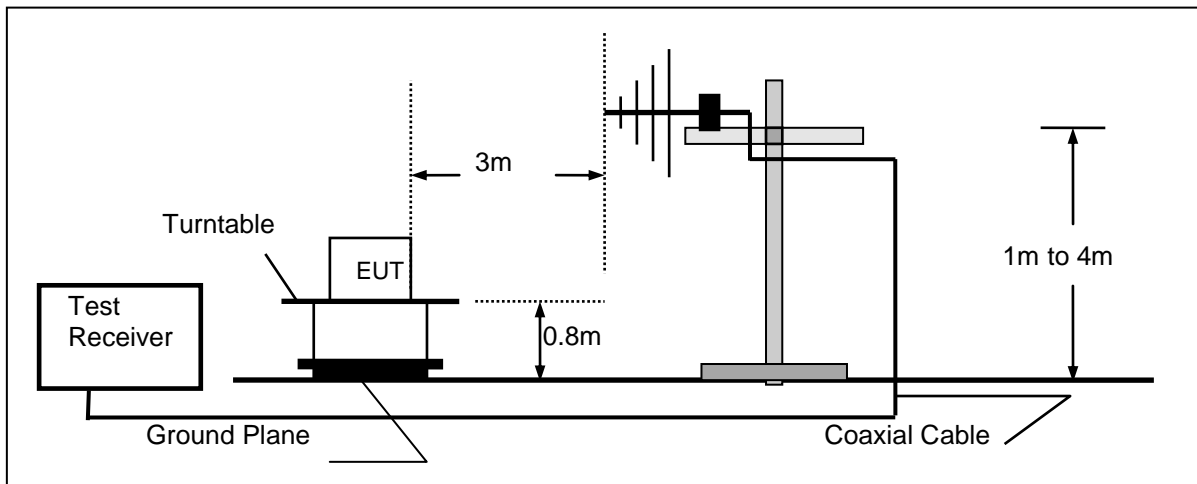

Frequency range above 1GHz

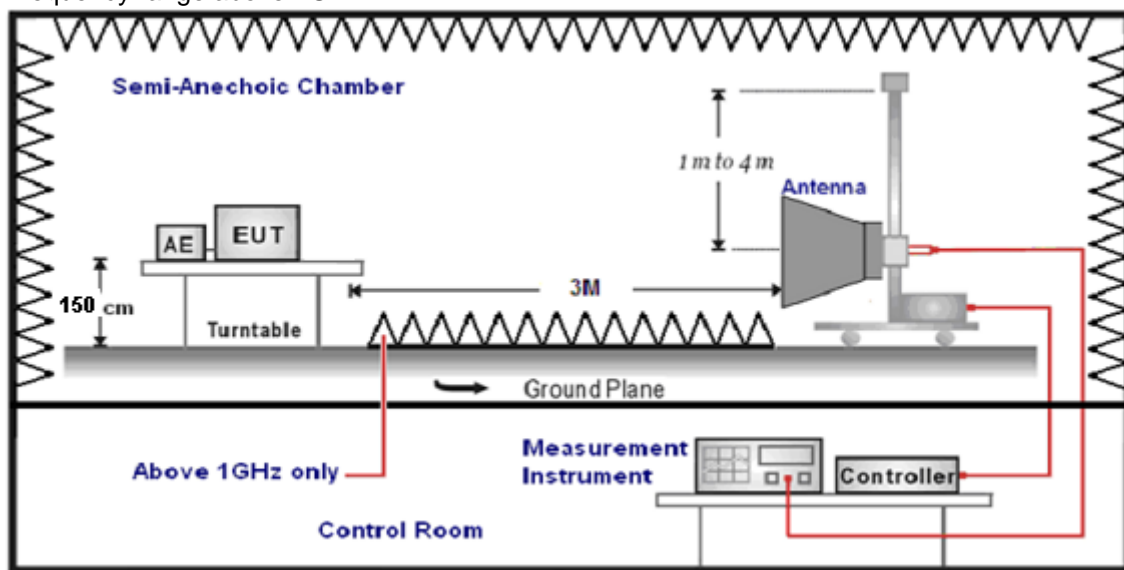

**TEST PROCEDURE**

1. The EUT was placed on a turn table which is 0.8m above ground plane when testing frequency range 9 KHz –1GHz;the EUT was placed on a turn table which is 1.5m above ground plane when testing above 1GHz.
2. Maximum procedure was performed by raising the receiving antenna from 1m to 4m and rotating the turn table from 0° to 360° to acquire the highest emissions from EUT.
3. And also, each emission was to be maximized by changing the polarization of receiving antenna both horizontal and vertical.
4. Repeat above procedures until all frequency measurements have been completed.
5. The EUT minimum operation frequency was 24MHz and maximum operation frequency was 5825MHz.so radiated emission test frequency band from 9KHz to 40GHz.
6. The distance between test antenna and EUT as following table states:

Test Frequency range	Test Antenna Type	Test Distance
9KHz-30MHz	Active Loop Antenna	3
30MHz-1GHz	Ultra-Broadband Antenna	3
1GHz-18GHz	Double Ridged Horn Antenna	3
18GHz-25GHz	Horn Antenna	1

7. Setting test receiver/spectrum as following table states:

Test Frequency range	Test Receiver/Spectrum Setting	Detector
9KHz-150KHz	RBW=200Hz/VBW=3KHz, Sweep time=Auto	QP
150KHz-30MHz	RBW=9KHz/VBW=100KHz, Sweep time=Auto	QP
30MHz-1GHz	RBW=120KHz/VBW=1000KHz, Sweep time=Auto	QP
1GHz-40GHz	Peak Value: RBW=1MHz/VBW=3MHz, Sweep time=Auto Average Value: RBW=1MHz/VBW=10Hz, Sweep time=Auto	Peak

**Field Strength Calculation**

The field strength is calculated by adding the Antenna Factor and Cable Factor and subtracting the Amplifier Gain and Duty Cycle Correction Factor(if any) from the measured reading. The basic equation with a sample calculation is as follows:

**FS = RA + AF + CL - AG**

Where FS = Field Strength	CL = Cable Attenuation Factor (Cable Loss)
RA = Reading Amplitude	AG = Amplifier Gain
AF = Antenna Factor	

Transd=AF +CL-AG

**RADIATION LIMIT**

According to §15.407 (b): Except as shown in paragraph (b)(7) of this section, the maximum emissions outside of the frequency bands of operation shall be attenuated in accordance with the following limits

Frequency (MHz)	EIRP Limit (dBm)	Equivalent Field Strength at 3m (dBµV/m)
5150-5250	-27	68.2
5250-5350	-27	68.2
5470-5725	-27	68.2
5725-5850	-27 (beyond 10MHz of the bandedge)	68.2
	-17 (within 10 MHz of band edge)	78.2

Frequency (MHz)	Distance (Meters)	Radiated (dBµV/m)	Radiated (µV/m)
0.009-0.49	3	$20\log(2400/F(KHz))+40\log(300/3)$	2400/F(KHz)
0.49-1.705	3	$20\log(24000/F(KHz))+ 40\log(30/3)$	24000/F(KHz)
1.705-30	3	$20\log(30)+ 40\log(30/3)$	30
30-88	3	40.0	100
88-216	3	43.5	150
216-960	3	46.0	200
Above 960	3	54.0	500

**TEST RESULTS**

Remark: We measured Radiated Emission at all mode from 9KHz to 25GHz in AC 120V/60Hz and the worst case was recorded.

Temperature	23.4°C	Humidity	54.5%
Test Engineer	Evan Ouyang	Configurations	IEEE 802.11ac20 HCH

**For 9 KHz~30MHz**

Freq. (MHz)	Level (dBuV)	Over Limit (dB)	Over Limit (dBuV)	Remark
-	-	-	-	See Note

Note:

The amplitude of spurious emissions which are attenuated by more than 20 dB below the permissible value has no need to be reported.

Distance extrapolation factor =  $40 \log(\text{specific distance} / \text{test distance})$  (dB);

Limit line = specific limits (dBuV) + distance extrapolation factor.

For 30MHz-1GHz  
Version A:

Adapter: CYSE65-240250

Horizontal

Test Graph

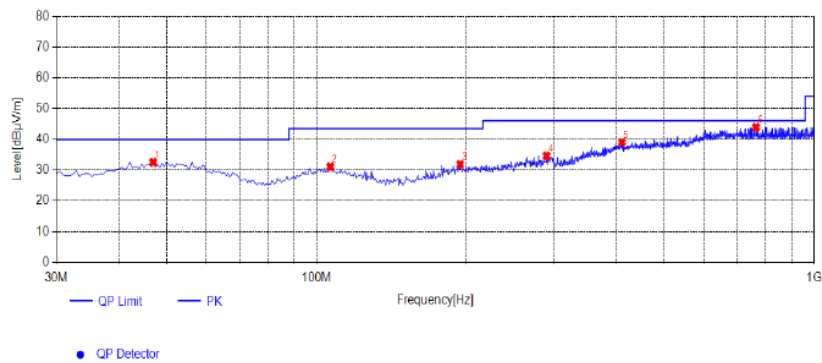

Suspected List

NO.	Frequency [MHz]	Reading [dBµV/m]	Factor [dB]	Result [dBµV/m]	Limit [dBµV/m]	Margin [dB]	Height [cm]	Angle [°]	Detector	Polarity	Remark
1	46.975	43.49	-10.93	32.56	40.00	7.44	100	358	PK	Horizontal	PASS
2	106.63	42.97	-11.88	31.09	43.50	12.41	100	90	PK	Horizontal	PASS
3	194.415	44.59	-12.68	31.91	43.50	11.59	100	284	PK	Horizontal	PASS
4	289.96	44.05	-9.46	34.59	46.00	11.41	100	52	PK	Horizontal	PASS
5	411.21	42.42	-3.38	39.04	46.00	6.96	100	324	PK	Horizontal	PASS
6	764.29	42.92	0.97	43.89	46.00	2.11	100	186	PK	Horizontal	PASS

Note: 1. Result (dBµV/m) = Reading(dBµV/m) + Factor (dB) .

2. Factor (dB) = Antenna Factor (dB/m) + Cable loss (dB) - Pre Amplifier gain (dB).

Vertical

Test Graph

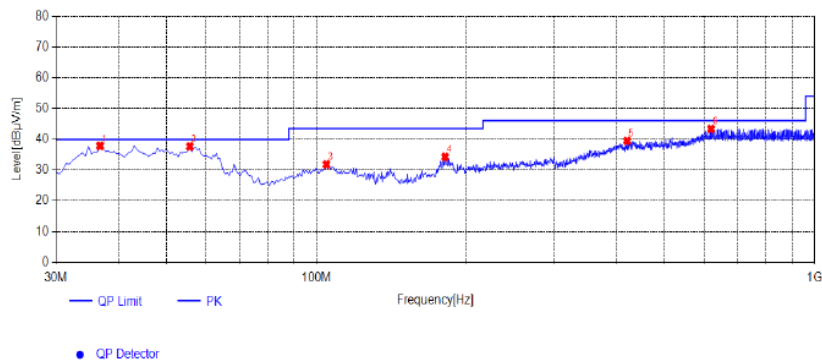

Suspected List

NO.	Frequency [MHz]	Reading [dBµV/m]	Factor [dB]	Result [dBµV/m]	Limit [dBµV/m]	Margin [dB]	Height [cm]	Angle [°]	Detector	Polarity	Remark
1	36.79	51.95	-14.12	37.83	40.00	2.17	100	48	PK	Vertical	PASS
2	55.705	49.48	-11.87	37.61	40.00	2.39	100	349	PK	Vertical	PASS
3	104.69	44.02	-12.19	31.83	43.50	11.67	100	269	PK	Vertical	PASS
4	181.32	48.73	-14.48	34.25	43.50	9.25	100	292	PK	Vertical	PASS
5	420.425	43.32	-3.85	39.47	46.00	6.53	100	230	PK	Vertical	PASS
6	619.76	44.56	-1.19	43.37	46.00	2.63	100	131	PK	Vertical	PASS

Note: 1. Result (dBµV/m) = Reading(dBµV/m) + Factor (dB) .

2. Factor (dB) = Antenna Factor (dB/m) + Cable loss (dB) - Pre Amplifier gain (dB).

Adapter: SOY-2400250-332-A

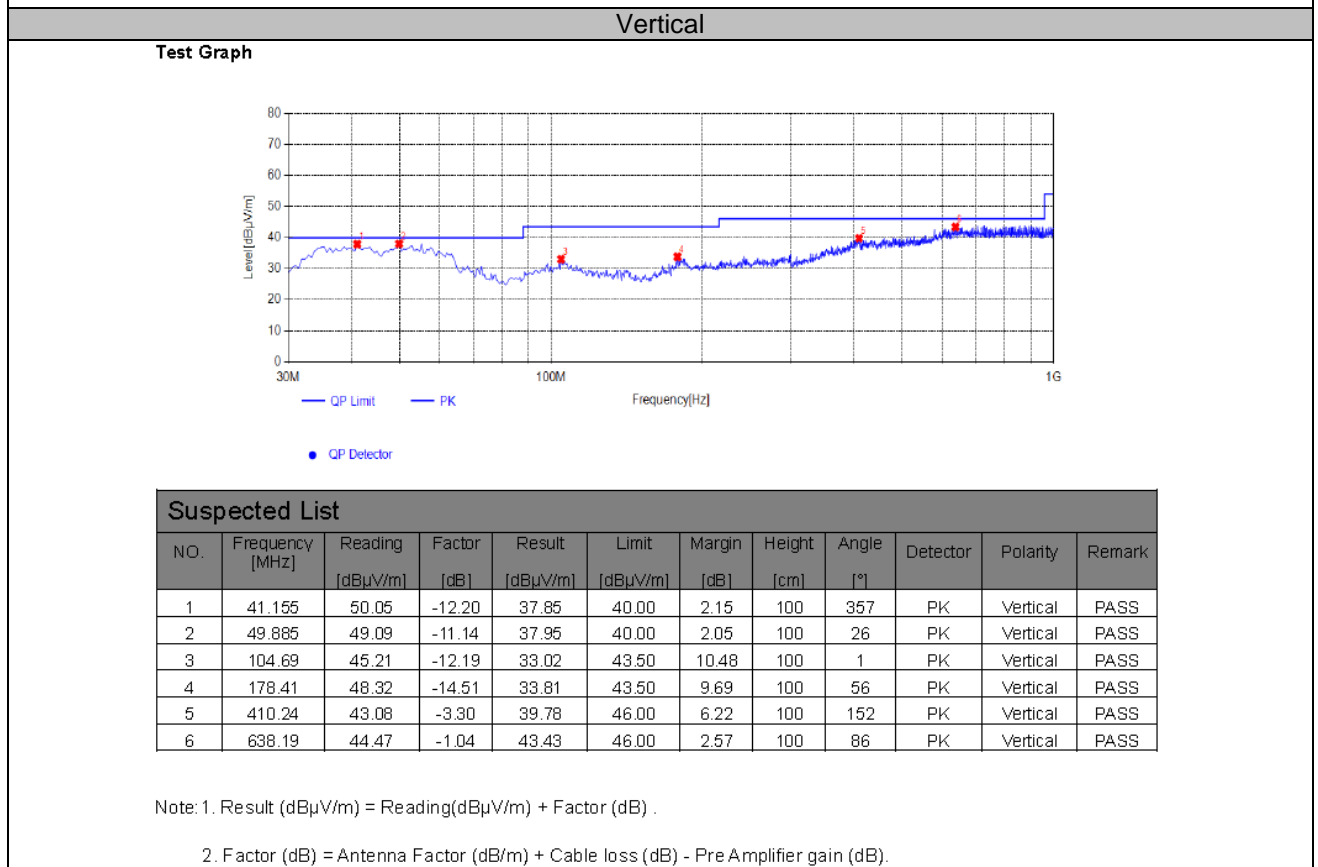
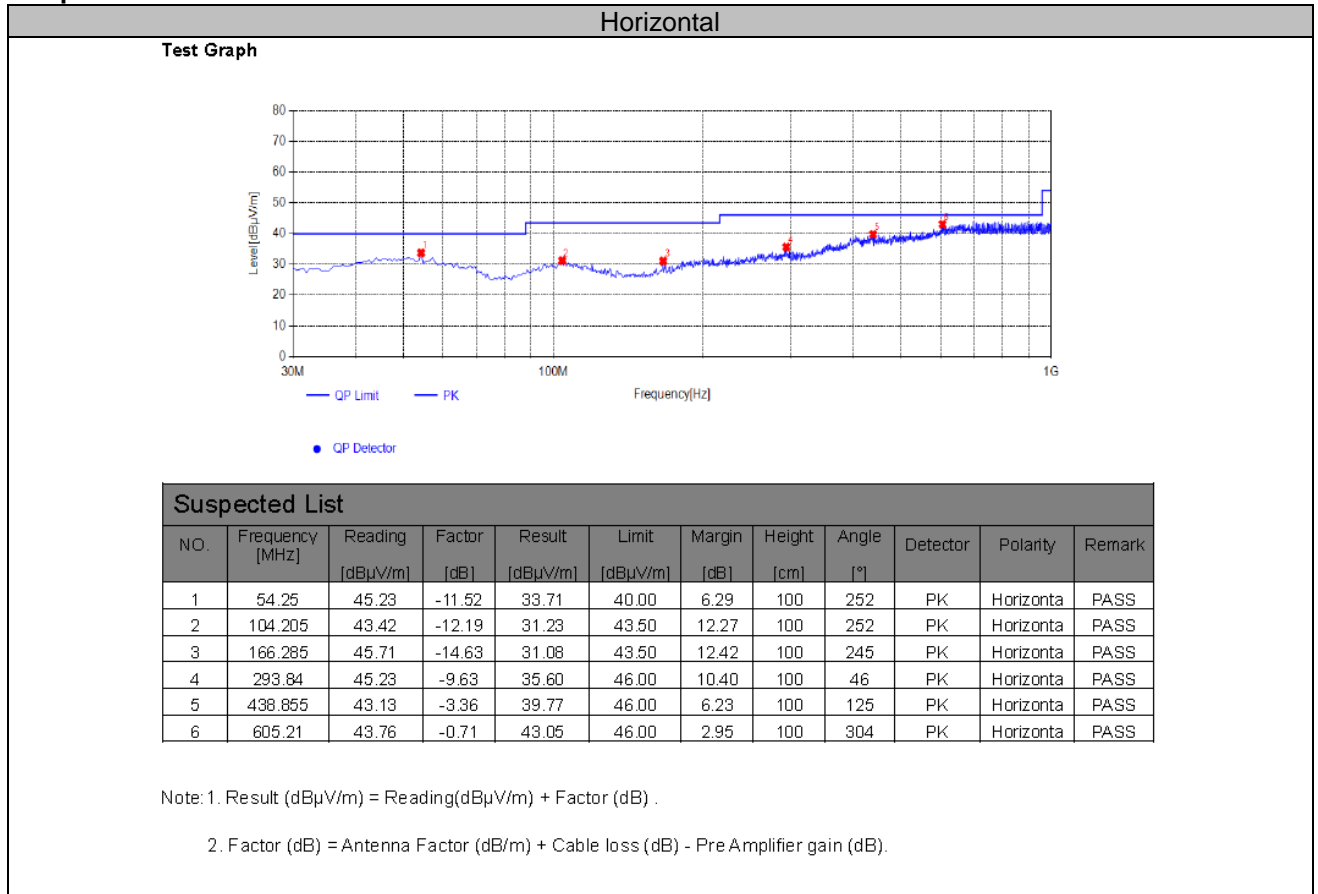

Adapter: AD65CM249250A

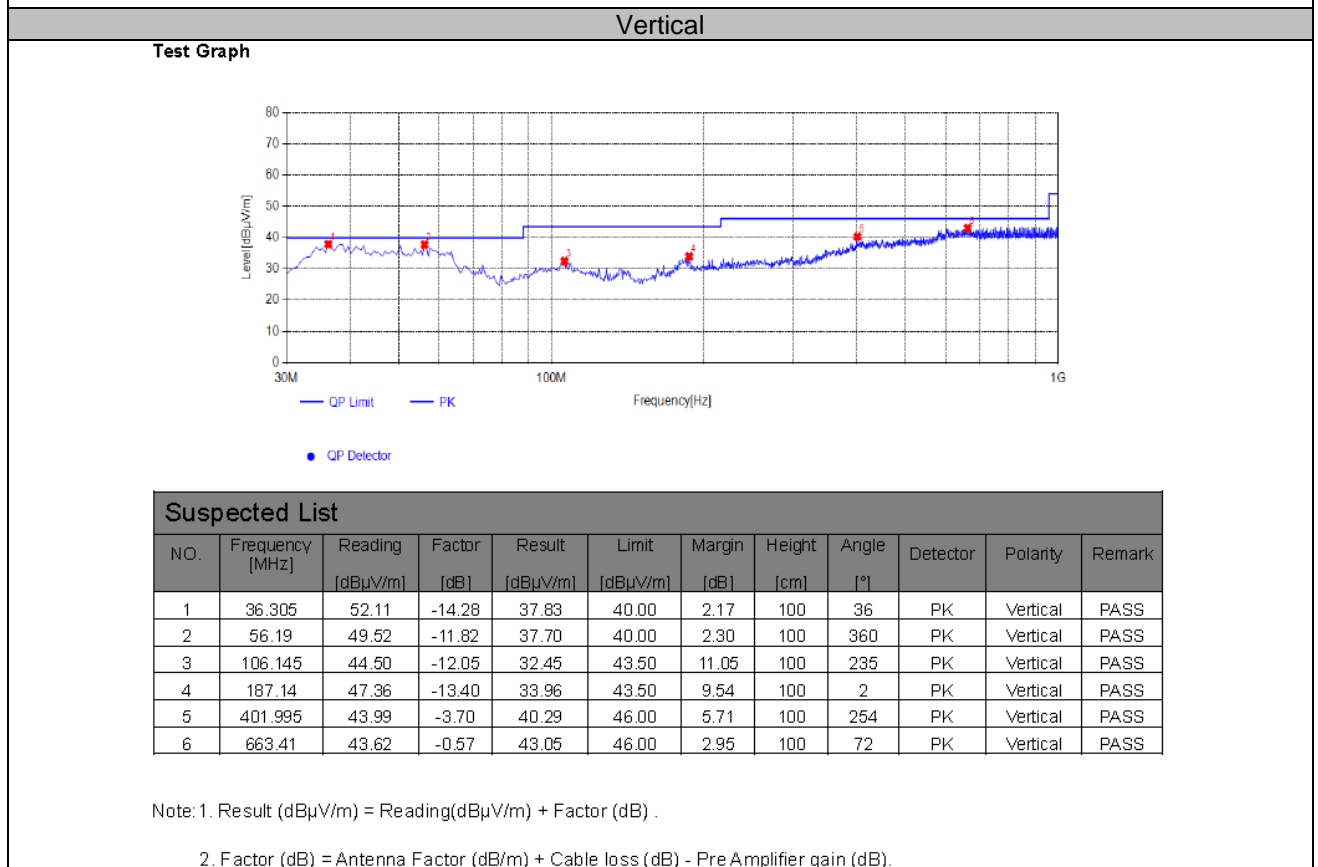
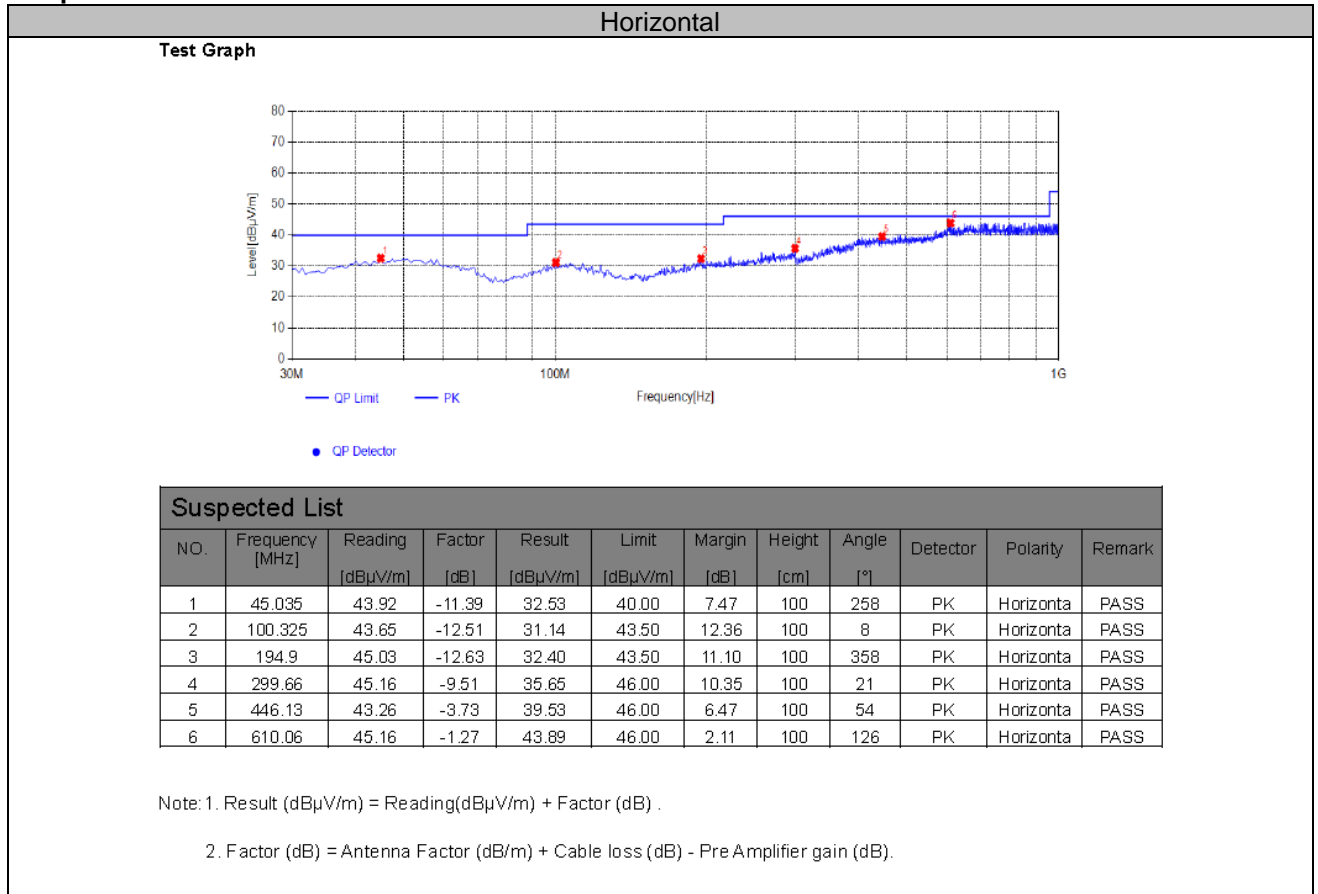

Adapter: ADS-65HI-19A-1 24060E

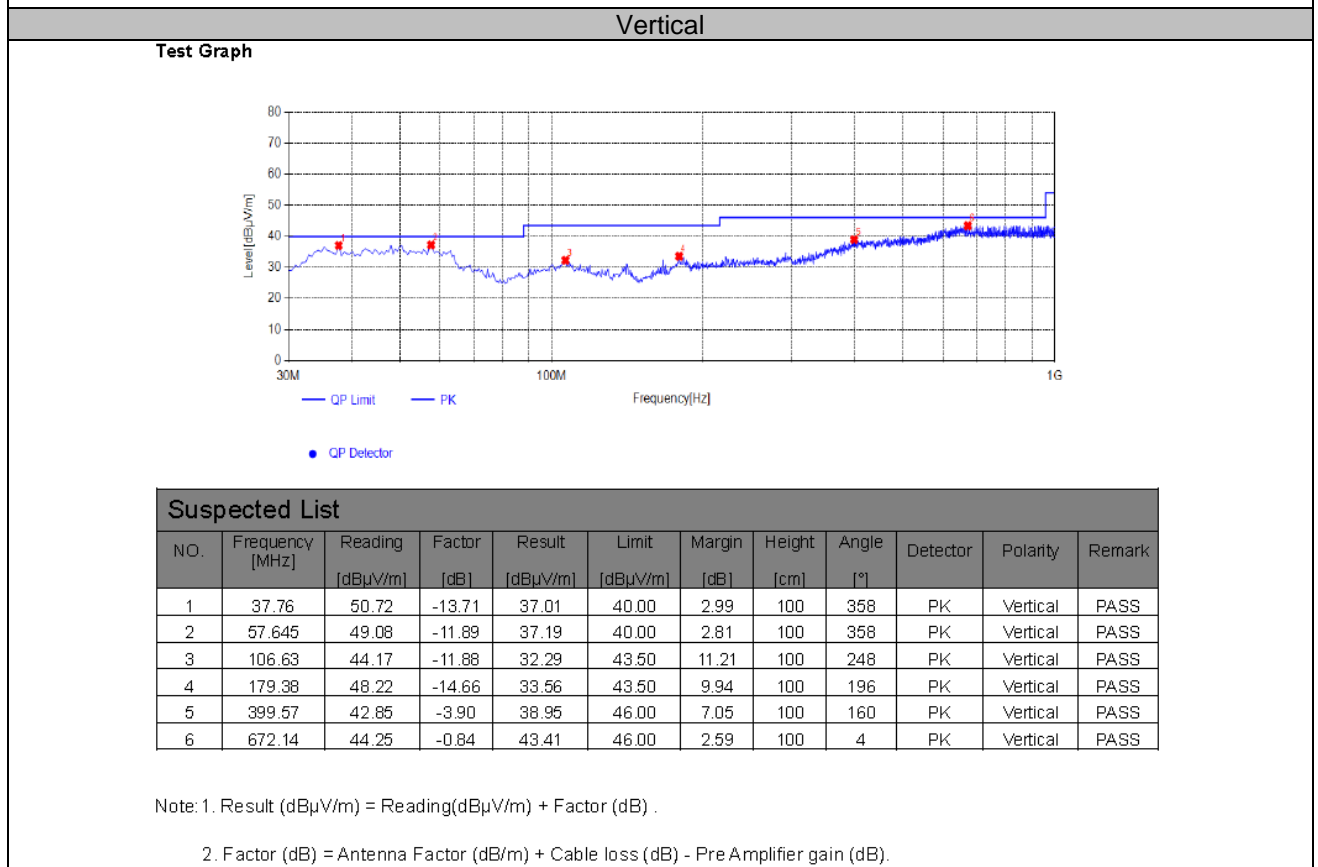
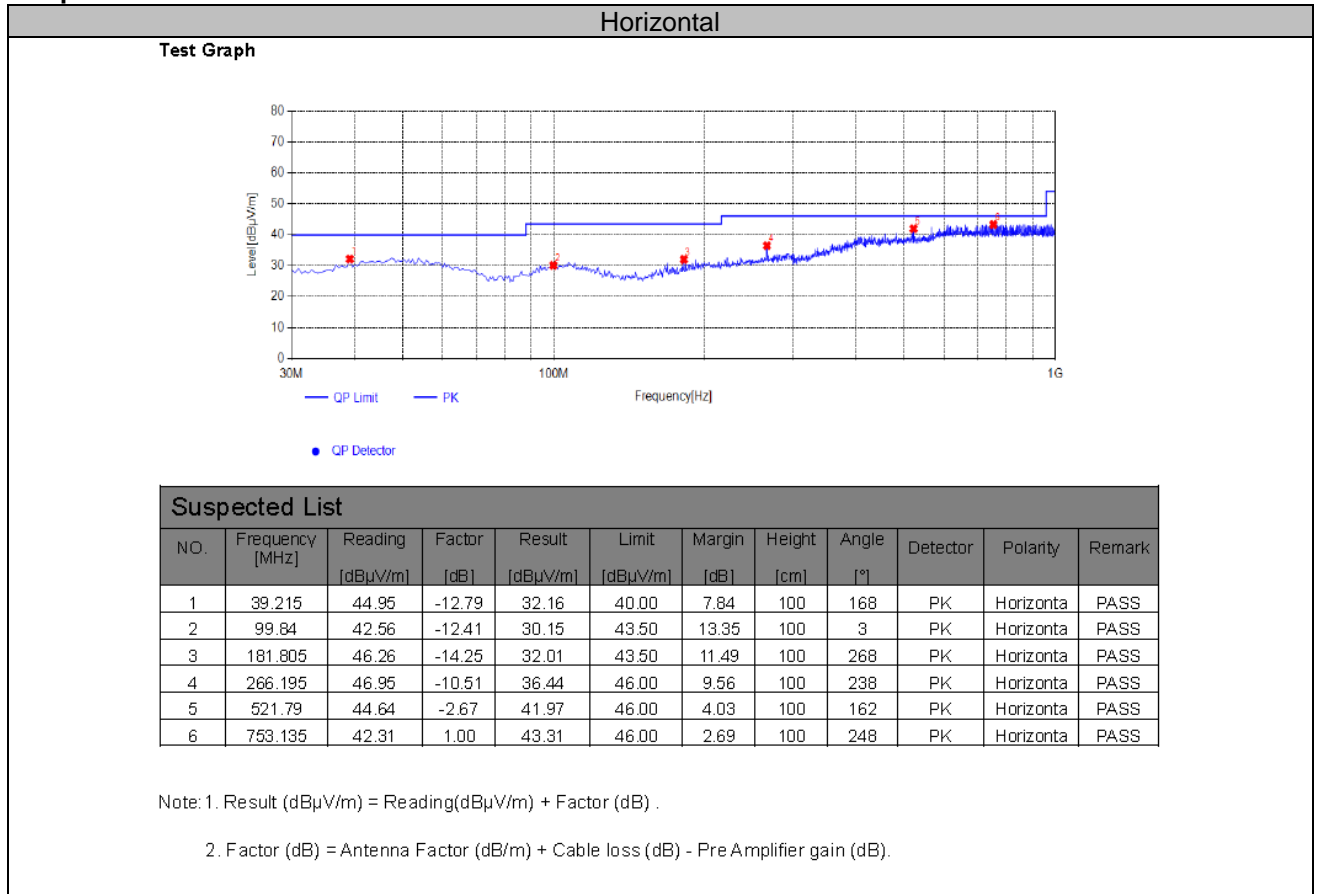



Version B:

Adapter: CYSE65-240250

**Horizontal**

Test Graph

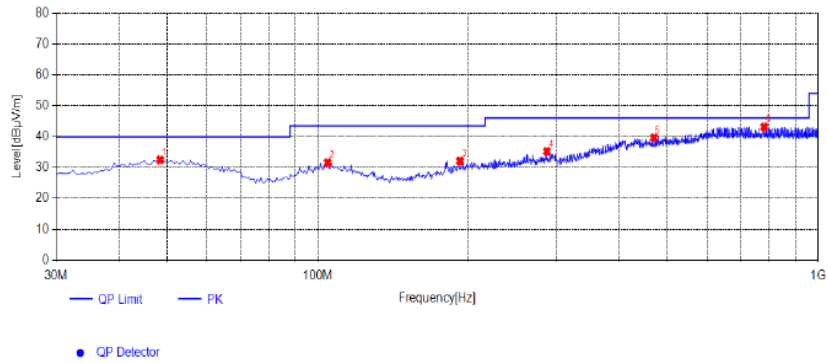

Suspected List

NO.	Frequency [MHz]	Reading [dBµV/m]	Factor [dB]	Result [dBµV/m]	Limit [dBµV/m]	Margin [dB]	Height [cm]	Angle [°]	Detector	Polarity	Remark
1	48.43	43.82	-11.36	32.46	40.00	7.54	100	176	PK	Horizontal	PASS
2	104.69	43.79	-12.19	31.60	43.50	11.90	100	288	PK	Horizontal	PASS
3	192.475	45.09	-12.98	32.11	43.50	11.39	100	282	PK	Horizontal	PASS
4	287.05	44.89	-9.72	35.17	46.00	10.83	100	110	PK	Horizontal	PASS
5	469.895	43.27	-3.63	39.64	46.00	6.36	100	272	PK	Horizontal	PASS
6	780.78	41.79	1.37	43.16	46.00	2.84	100	106	PK	Horizontal	PASS

Note: 1. Result (dBµV/m) = Reading(dBµV/m) + Factor (dB) .

2. Factor (dB) = Antenna Factor (dB/m) + Cable loss (dB) - Pre Amplifier gain (dB).

**Vertical**

Test Graph

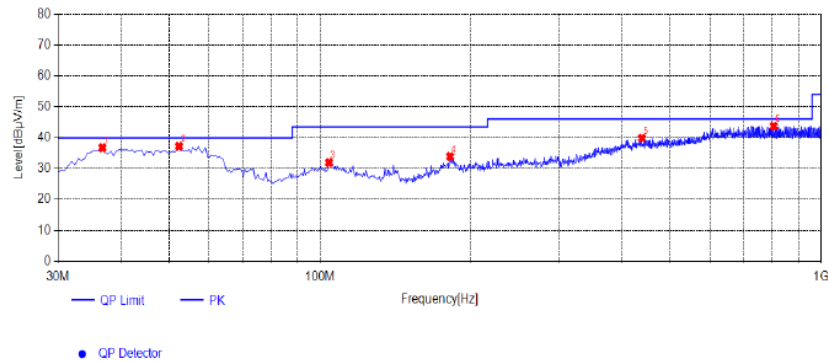

Suspected List

NO.	Frequency [MHz]	Reading [dBµV/m]	Factor [dB]	Result [dBµV/m]	Limit [dBµV/m]	Margin [dB]	Height [cm]	Angle [°]	Detector	Polarity	Remark
1	36.79	50.82	-14.12	36.70	40.00	3.30	100	39	PK	Vertical	PASS
2	52.31	48.45	-11.29	37.16	40.00	2.84	100	349	PK	Vertical	PASS
3	104.205	44.13	-12.19	31.94	43.50	11.56	100	337	PK	Vertical	PASS
4	181.805	48.16	-14.25	33.91	43.50	9.59	100	39	PK	Vertical	PASS
5	438.855	43.27	-3.36	39.91	46.00	6.09	100	191	PK	Vertical	PASS
6	804.06	41.96	1.76	43.72	46.00	2.28	100	264	PK	Vertical	PASS

Note: 1. Result (dBµV/m) = Reading(dBµV/m) + Factor (dB) .

2. Factor (dB) = Antenna Factor (dB/m) + Cable loss (dB) - Pre Amplifier gain (dB).

Adapter: SOY-2400250-332-A

**Horizontal**

**Test Graph**

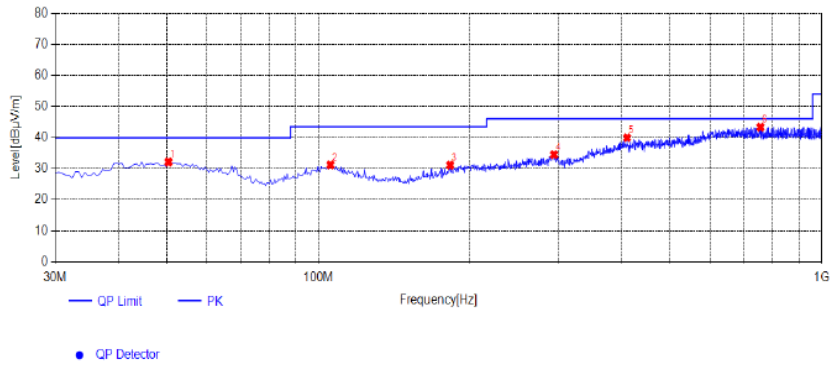

**Suspected List**

NO.	Frequency [MHz]	Reading [dBµV/m]	Factor [dB]	Result [dBµV/m]	Limit [dBµV/m]	Margin [dB]	Height [cm]	Angle [°]	Detector	Polarity	Remark
1	50.37	43.26	-11.11	32.15	40.00	7.85	100	228	PK	Horizontal	PASS
2	105.66	43.33	-12.11	31.22	43.50	12.28	100	287	PK	Horizontal	PASS
3	182.775	44.96	-13.82	31.14	43.50	12.36	100	89	PK	Horizontal	PASS
4	293.84	44.10	-9.63	34.47	46.00	11.53	100	264	PK	Horizontal	PASS
5	410.725	43.25	-3.29	39.96	46.00	6.04	100	160	PK	Horizontal	PASS
6	756.045	42.34	1.02	43.36	46.00	2.64	100	297	PK	Horizontal	PASS

Note: 1. Result (dBµV/m) = Reading(dBµV/m) + Factor (dB) .

2. Factor (dB) = Antenna Factor (dB/m) + Cable loss (dB) - Pre Amplifier gain (dB).

**Vertical**

**Test Graph**

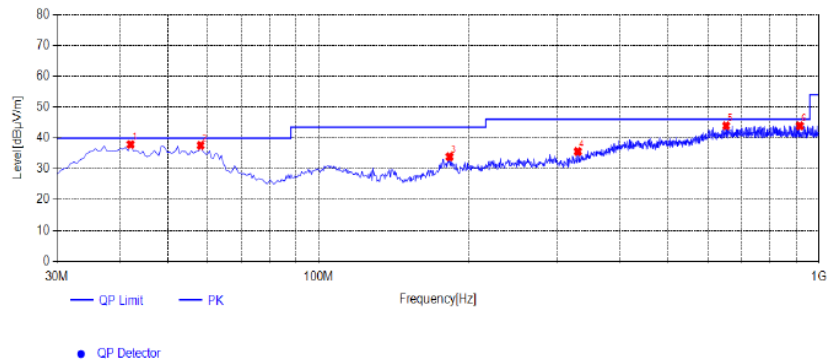

**Suspected List**

NO.	Frequency [MHz]	Reading [dBµV/m]	Factor [dB]	Result [dBµV/m]	Limit [dBµV/m]	Margin [dB]	Height [cm]	Angle [°]	Detector	Polarity	Remark
1	42.125	49.93	-12.08	37.85	40.00	2.15	100	66	PK	Vertical	PASS
2	58.13	49.66	-12.15	37.51	40.00	2.49	100	341	PK	Vertical	PASS
3	182.775	47.72	-13.82	33.90	43.50	9.60	100	228	PK	Vertical	PASS
4	329.73	43.56	-7.99	35.57	46.00	10.43	100	57	PK	Vertical	PASS
5	652.74	44.52	-0.57	43.95	46.00	2.05	100	285	PK	Vertical	PASS
6	916.095	40.40	3.53	43.93	46.00	2.07	100	106	PK	Vertical	PASS

Note: 1. Result (dBµV/m) = Reading(dBµV/m) + Factor (dB) .

2. Factor (dB) = Antenna Factor (dB/m) + Cable loss (dB) - Pre Amplifier gain (dB).

Adapter: AD65CM249250A

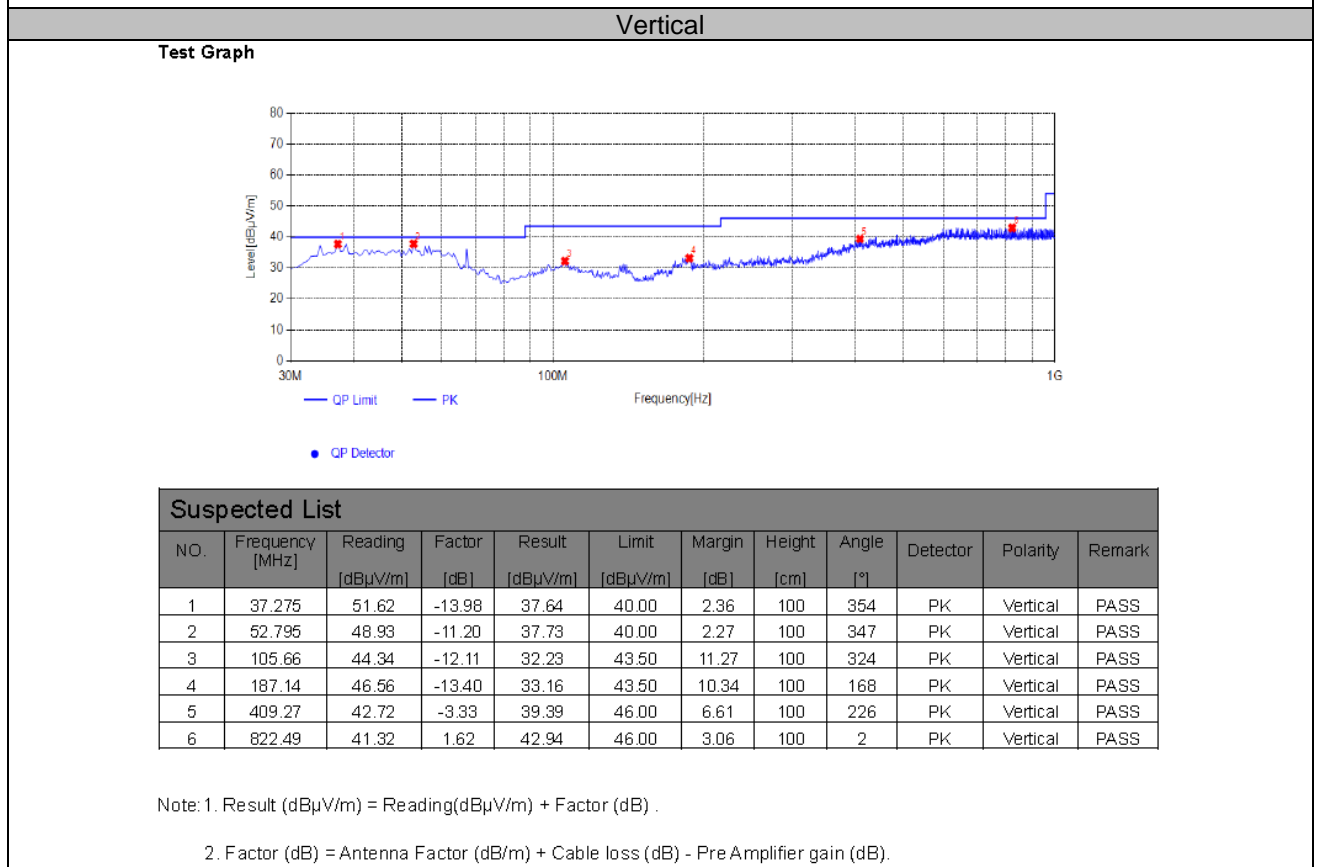
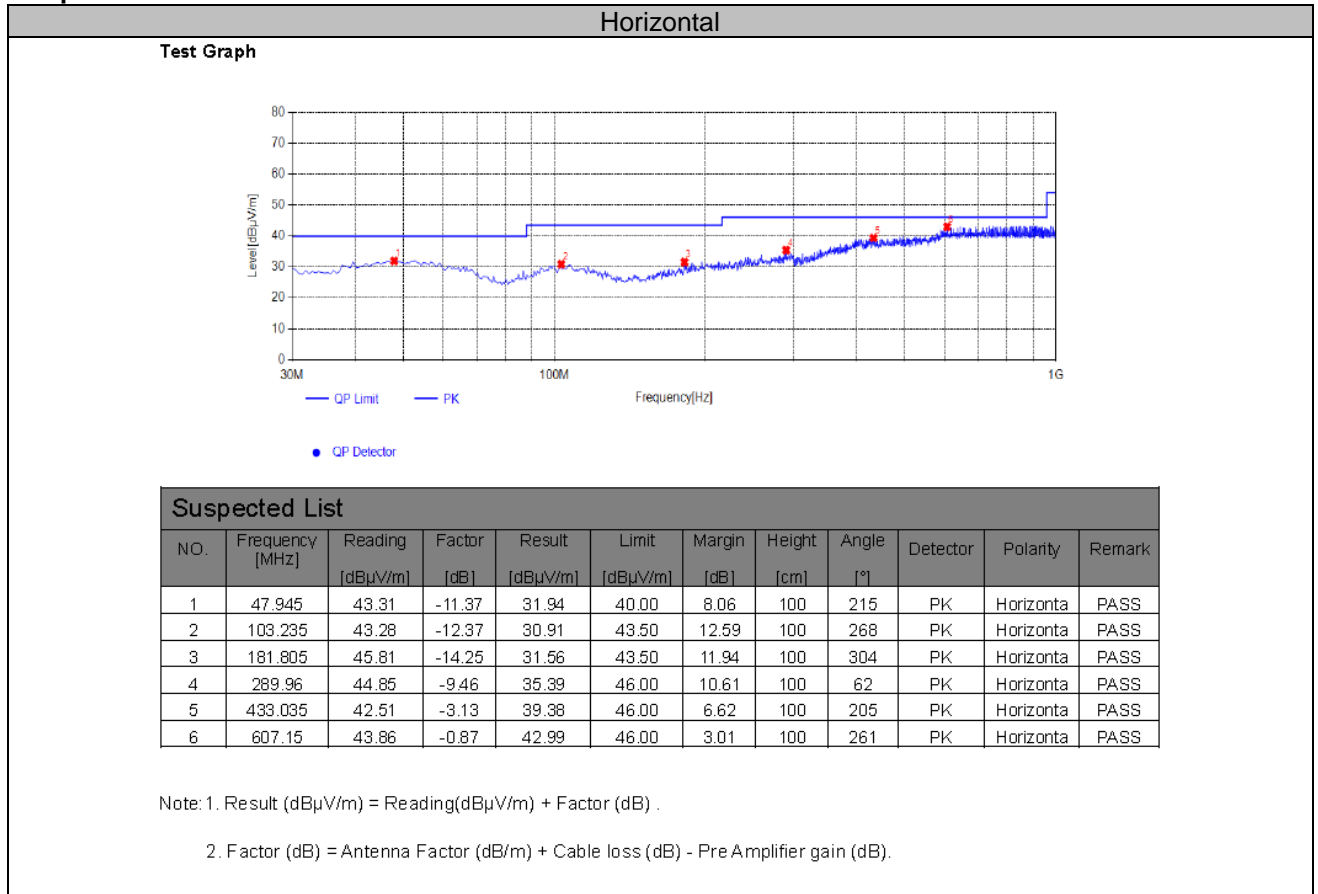

Adapter: ADS-65HI-19A-1 24060E

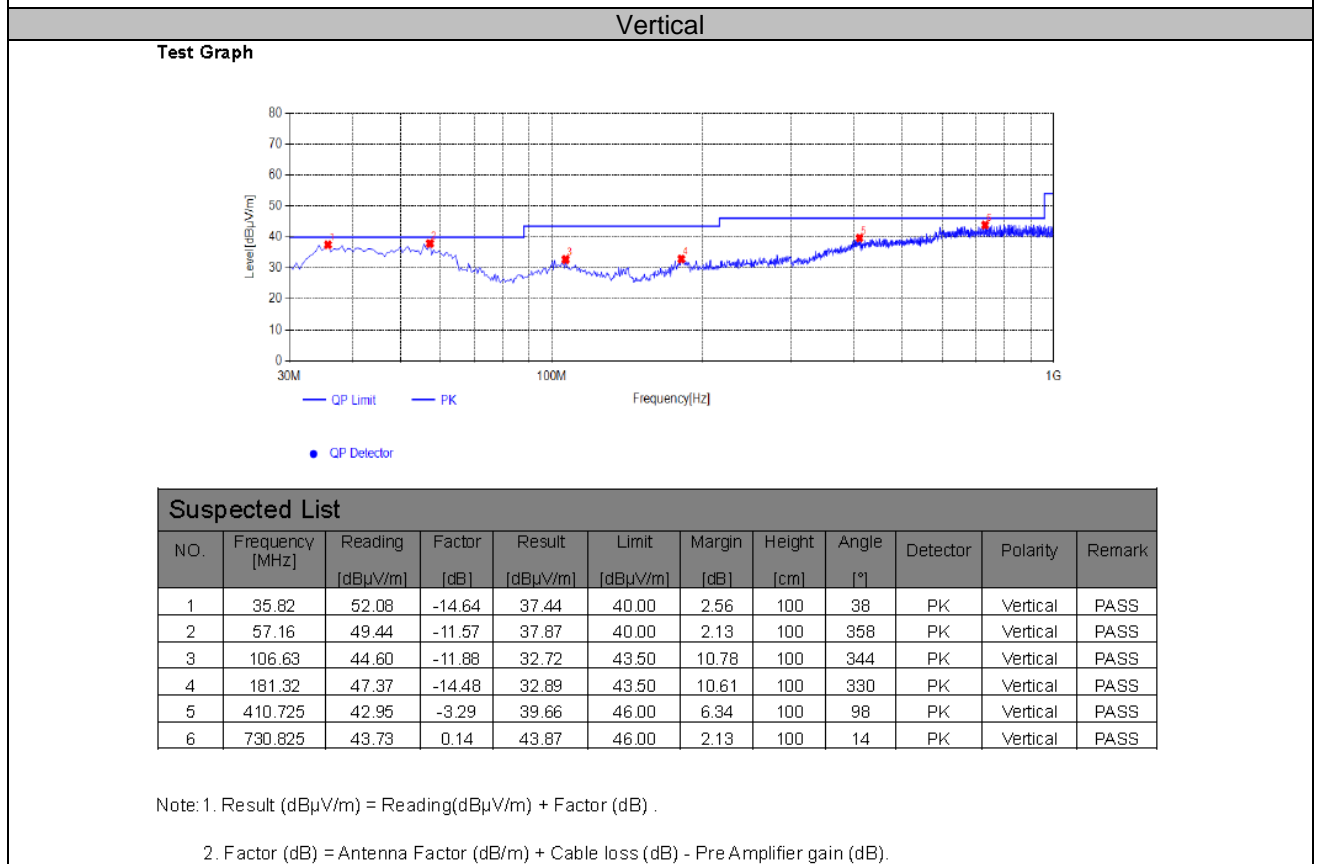
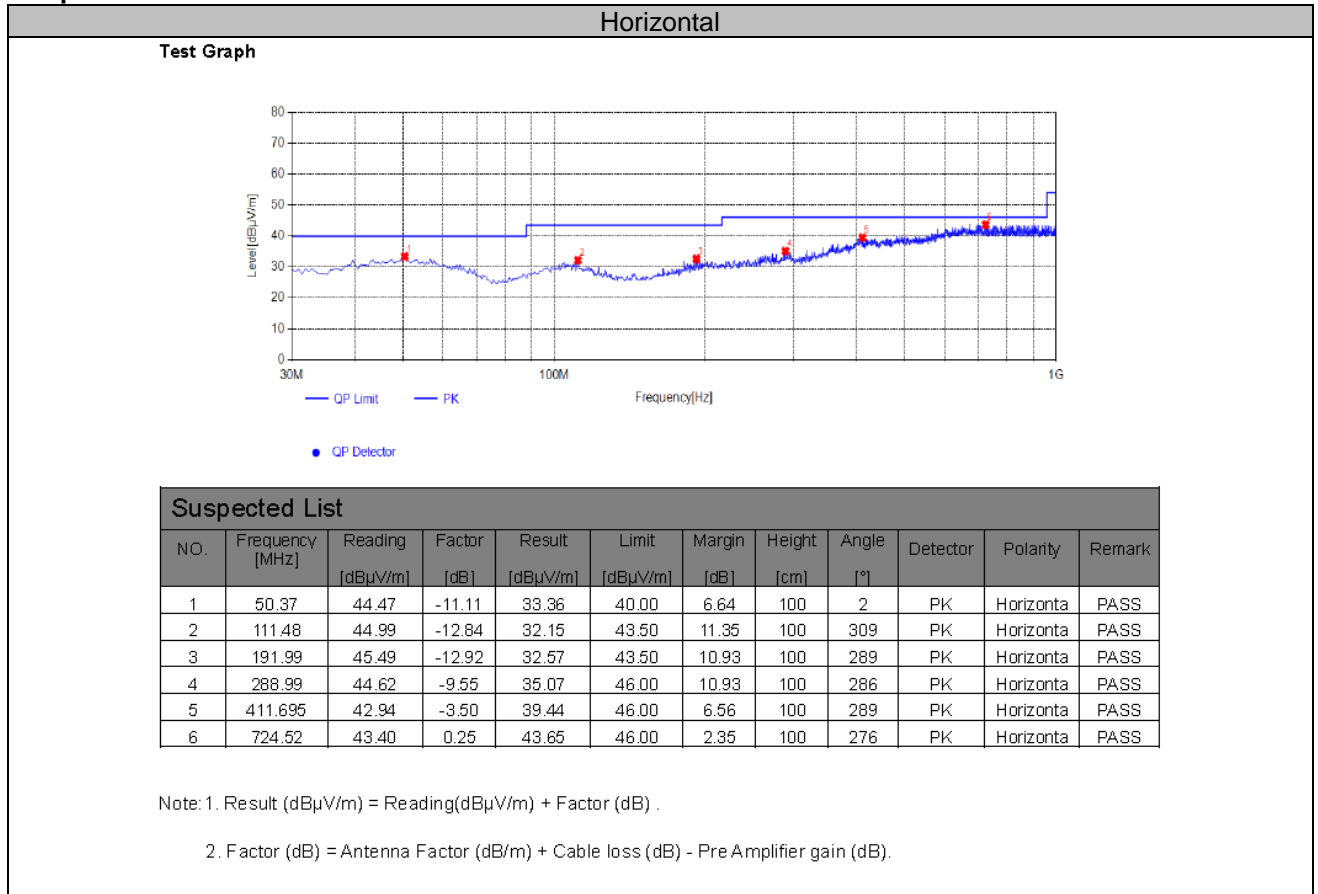

Version C:

Adapter: CYSE65-240250

**Horizontal**

Test Graph

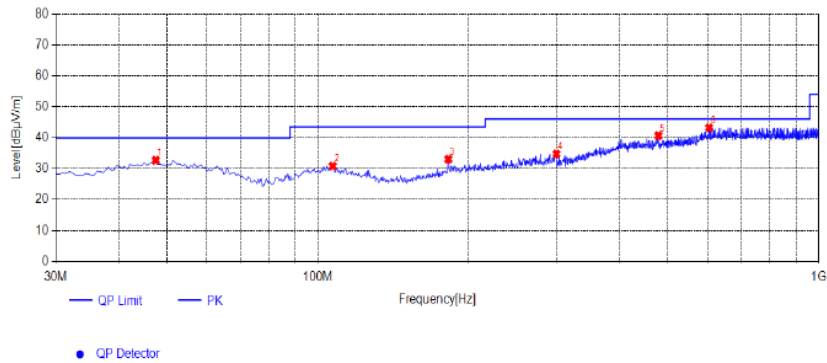

Suspected List

NO.	Frequency [MHz]	Reading [dBµV/m]	Factor [dB]	Result [dBµV/m]	Limit [dBµV/m]	Margin [dB]	Height [cm]	Angle [°]	Detector	Polarity	Remark
1	47.46	43.93	-11.21	32.72	40.00	7.28	100	248	PK	Horizontal	PASS
2	107.115	42.65	-11.80	30.85	43.50	12.65	100	60	PK	Horizontal	PASS
3	182.29	47.08	-14.03	33.05	43.50	10.45	100	47	PK	Horizontal	PASS
4	299.66	44.25	-9.51	34.74	46.00	11.26	100	262	PK	Horizontal	PASS
5	478.625	43.76	-3.04	40.72	46.00	5.28	100	291	PK	Horizontal	PASS
6	604.24	44.09	-0.84	43.25	46.00	2.75	100	160	PK	Horizontal	PASS

Note: 1. Result (dBµV/m) = Reading(dBµV/m) + Factor (dB) .

2. Factor (dB) = Antenna Factor (dB/m) + Cable loss (dB) - Pre Amplifier gain (dB).

**Vertical**

Test Graph

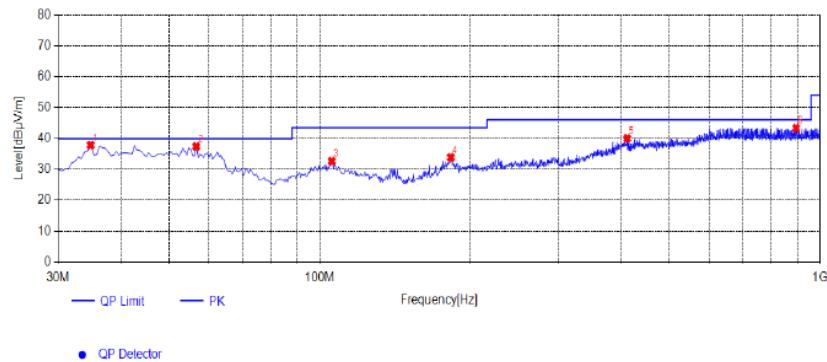

Suspected List

NO.	Frequency [MHz]	Reading [dBµV/m]	Factor [dB]	Result [dBµV/m]	Limit [dBµV/m]	Margin [dB]	Height [cm]	Angle [°]	Detector	Polarity	Remark
1	34.85	52.58	-14.75	37.83	40.00	2.17	100	59	PK	Vertical	PASS
2	56.675	48.96	-11.61	37.35	40.00	2.65	100	354	PK	Vertical	PASS
3	105.66	44.77	-12.11	32.66	43.50	10.84	100	2	PK	Vertical	PASS
4	182.775	47.67	-13.82	33.85	43.50	9.65	100	222	PK	Vertical	PASS
5	411.695	43.53	-3.50	40.03	46.00	5.97	100	3	PK	Vertical	PASS
6	895.725	40.83	2.53	43.36	46.00	2.64	100	102	PK	Vertical	PASS

Note: 1. Result (dBµV/m) = Reading(dBµV/m) + Factor (dB) .

2. Factor (dB) = Antenna Factor (dB/m) + Cable loss (dB) - Pre Amplifier gain (dB).

Adapter: SOY-2400250-332-A

**Horizontal**

**Test Graph**

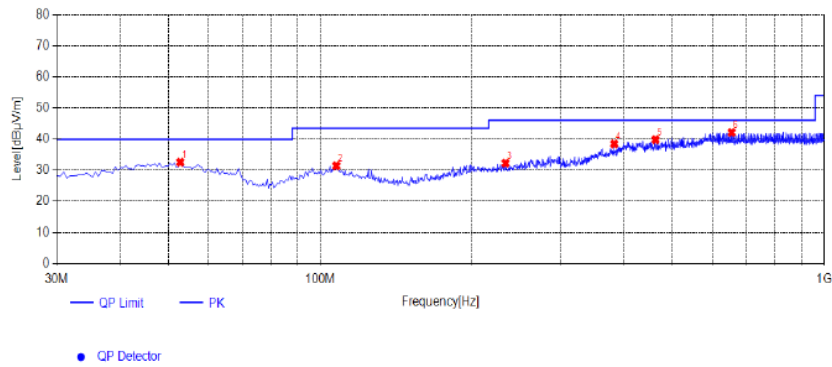

**Suspected List**

NO.	Frequency [MHz]	Reading [dBµV/m]	Factor [dB]	Result [dBµV/m]	Limit [dBµV/m]	Margin [dB]	Height [cm]	Angle [°]	Detector	Polarity	Remark
1	52.795	43.78	-11.20	32.58	40.00	7.42	100	56	PK	Horizontal	PASS
2	107.6	43.40	-11.97	31.43	43.50	12.07	100	352	PK	Horizontal	PASS
3	233.215	43.99	-11.72	32.27	46.00	13.73	100	129	PK	Horizontal	PASS
4	383.08	43.72	-5.28	38.44	46.00	7.56	100	12	PK	Horizontal	PASS
5	462.62	43.02	-3.20	39.82	46.00	6.18	100	2	PK	Horizontal	PASS
6	655.165	42.56	-0.41	42.15	46.00	3.85	100	2	PK	Horizontal	PASS

Note: 1. Result (dBµV/m) = Reading(dBµV/m) + Factor (dB) .

2. Factor (dB) = Antenna Factor (dB/m) + Cable loss (dB) - Pre Amplifier gain (dB).

**Vertical**

**Test Graph**

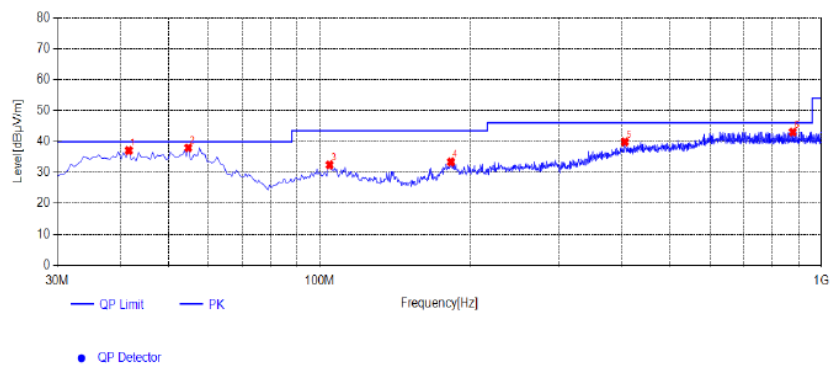

**Suspected List**

NO.	Frequency [MHz]	Reading [dBµV/m]	Factor [dB]	Result [dBµV/m]	Limit [dBµV/m]	Margin [dB]	Height [cm]	Angle [°]	Detector	Polarity	Remark
1	41.64	49.19	-12.13	37.06	40.00	2.94	100	0	PK	Vertical	PASS
2	54.735	49.75	-11.83	37.92	40.00	2.08	100	314	PK	Vertical	PASS
3	104.69	44.64	-12.19	32.45	43.50	11.05	100	6	PK	Vertical	PASS
4	182.775	47.21	-13.82	33.39	43.50	10.11	100	174	PK	Vertical	PASS
5	405.875	43.32	-3.45	39.87	46.00	6.13	100	108	PK	Vertical	PASS
6	877.78	41.18	1.90	43.08	46.00	2.92	100	171	PK	Vertical	PASS

Note: 1. Result (dBµV/m) = Reading(dBµV/m) + Factor (dB) .

2. Factor (dB) = Antenna Factor (dB/m) + Cable loss (dB) - Pre Amplifier gain (dB).

Adapter: AD65CM249250A

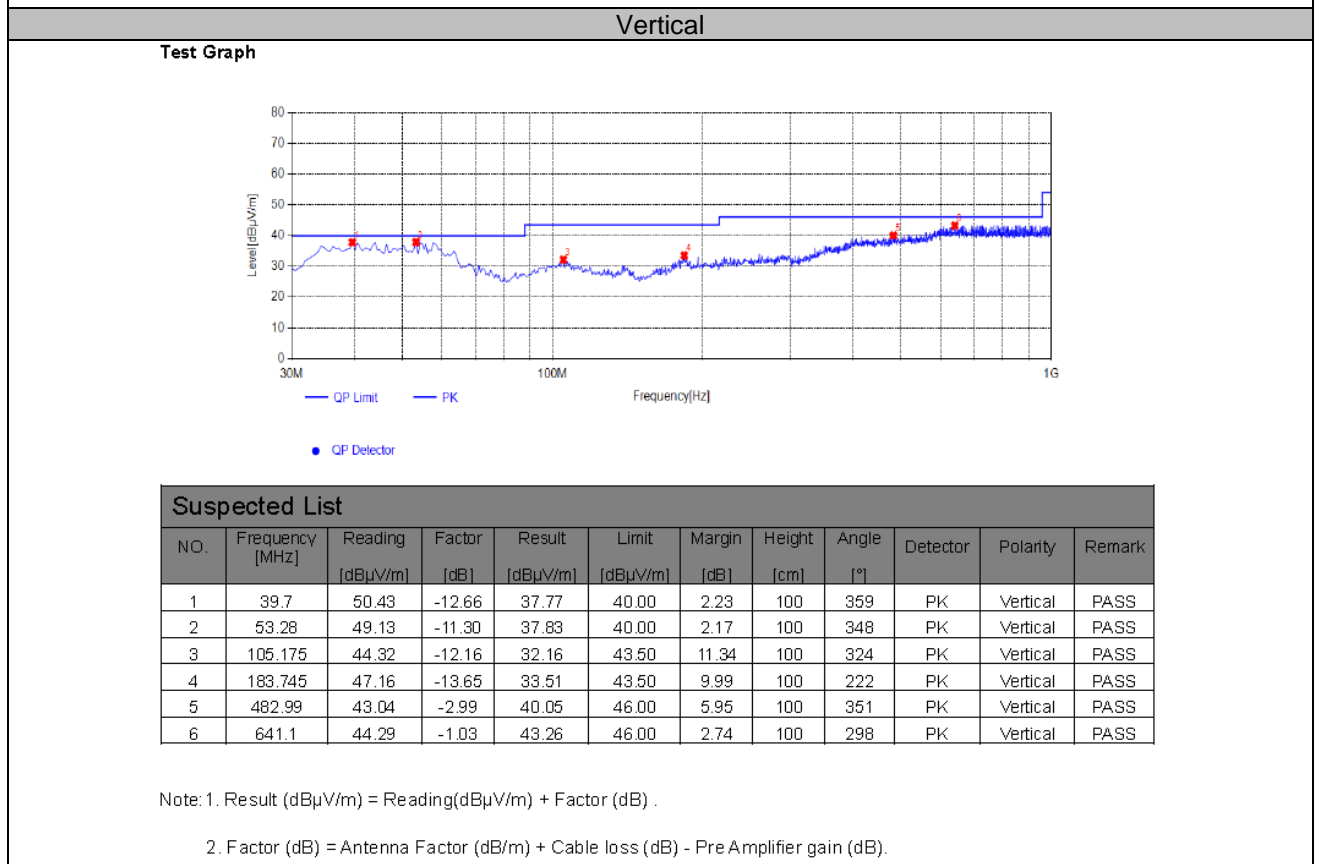
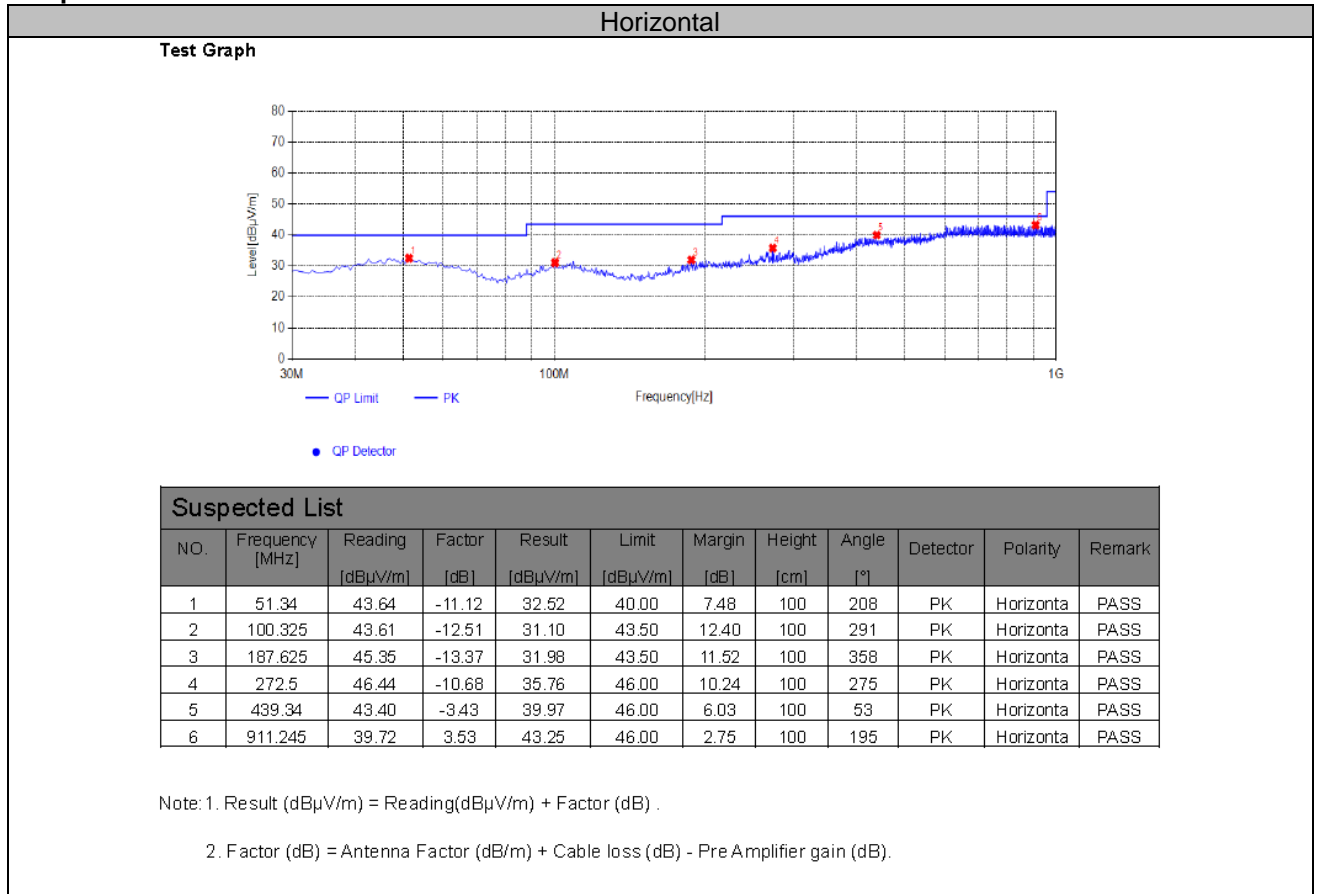

Adapter: ADS-65HI-19A-1 24060E

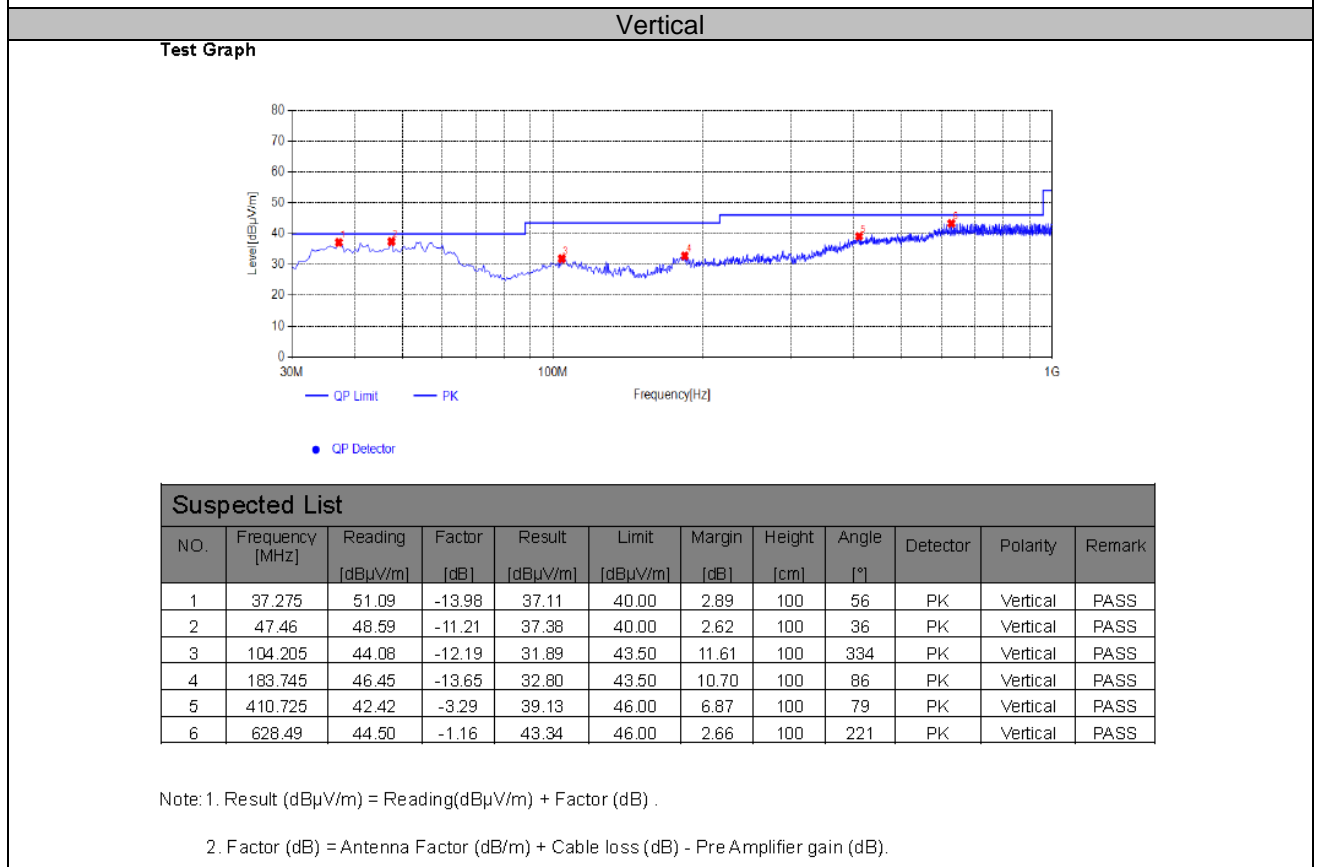
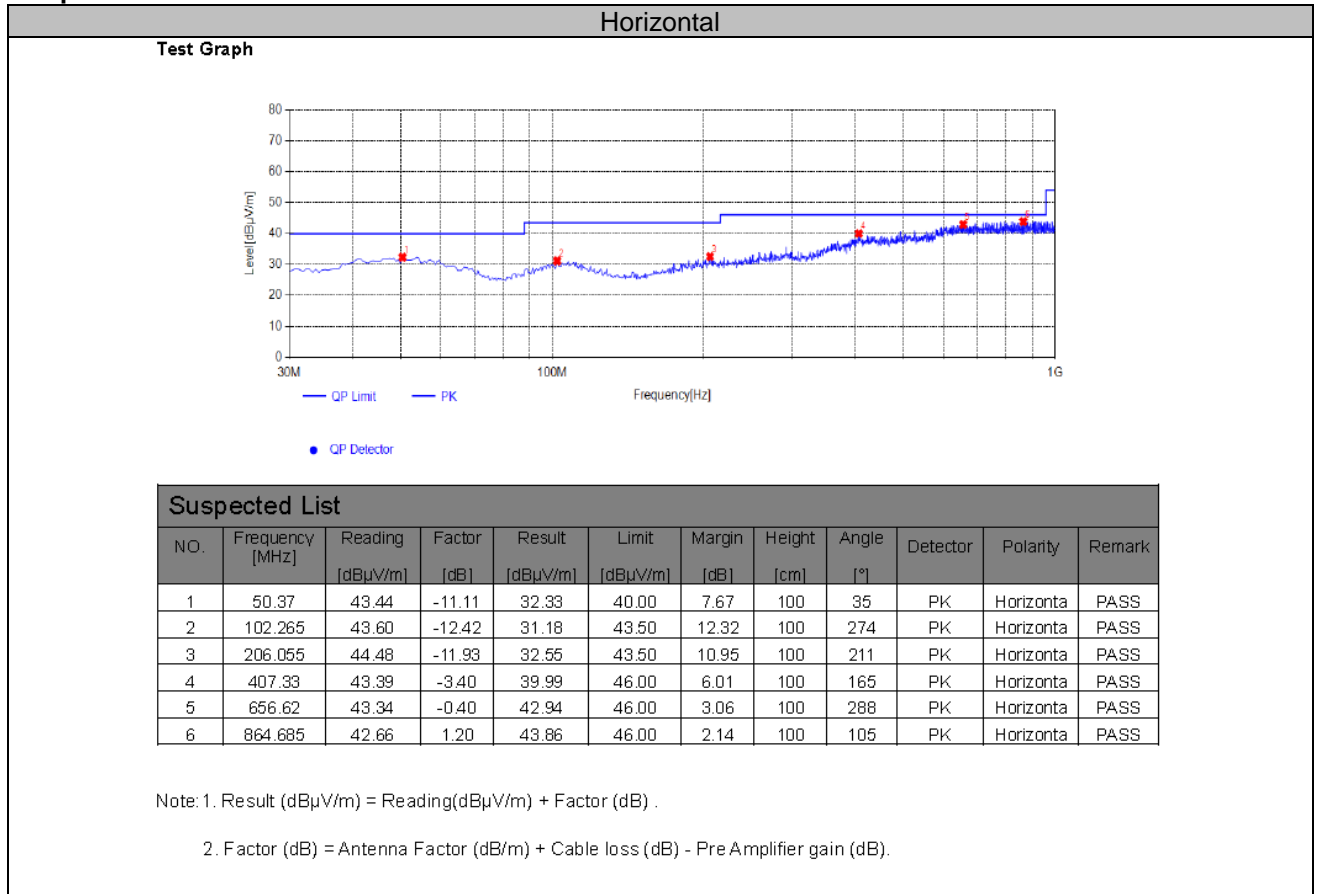



For 1GHz to 40GHz  
5150-5250MHz:

IEEE 802.11ac HT20\_MIMO  
802.11ac20 Mode\_Channel 36\_5180 MHz

Item (Mark)	Freq (MHz)	Read Level (dB $\mu$ V)	Antenna Factor (dB/m)	PRM Factor dB	Cable Loss (dB)	Result Level (dB $\mu$ V/m)	Limit Line (dB $\mu$ V/m)	Margin (dB)	Detector	Polarization
1	10360	40.45	38.55	33.13	11.26	57.13	68.20	-11.07	Peak	Horizontal
1	10360	30.59	38.55	33.13	11.26	47.27	54.00	-6.73	AV	Horizontal
1	10360	41.62	38.55	33.13	11.26	58.30	68.20	-9.90	Peak	Vertical
1	10360	28.39	38.55	33.13	11.26	45.07	54.00	-8.93	AV	Vertical

802.11ac20 Mode\_Channel 40\_5200 MHz

Item (Mark)	Freq (MHz)	Read Level (dB $\mu$ V)	Antenna Factor (dB/m)	PRM Factor dB	Cable Loss (dB)	Result Level (dB $\mu$ V/m)	Limit Line (dB $\mu$ V/m)	Margin (dB)	Detector	Polarization
1	10400	40.49	38.55	33.13	11.26	57.17	68.20	-11.03	Peak	Horizontal
1	10400	31.19	38.55	33.13	11.26	47.87	54.00	-6.13	AV	Horizontal
1	10400	40.44	38.55	33.13	11.26	57.12	68.20	-11.08	Peak	Vertical
1	10400	28.43	38.55	33.13	11.26	45.11	54.00	-8.89	AV	Vertical

802.11ac20 Mode\_Channel 48\_5240 MHz

Item (Mark)	Freq (MHz)	Read Level (dB $\mu$ V)	Antenna Factor (dB/m)	PRM Factor dB	Cable Loss (dB)	Result Level (dB $\mu$ V/m)	Limit Line (dB $\mu$ V/m)	Margin (dB)	Detector	Polarization
1	10480	39.13	38.55	33.13	11.26	55.81	68.20	-12.39	Peak	Horizontal
1	10480	30.78	38.55	33.13	11.26	47.46	54.00	-6.54	AV	Horizontal
1	10480	41.55	38.55	33.13	11.26	58.23	68.20	-9.97	Peak	Vertical
1	10480	28.89	38.55	33.13	11.26	45.57	54.00	-8.43	AV	Vertical

IEEE 802.11ax HT20\_MIMO  
802.11ax20 Mode\_Channel 36\_5180 MHz

Item (Mark)	Freq (MHz)	Read Level (dB $\mu$ V)	Antenna Factor (dB/m)	PRM Factor dB	Cable Loss (dB)	Result Level (dB $\mu$ V/m)	Limit Line (dB $\mu$ V/m)	Margin (dB)	Detector	Polarization
1	10360	40.51	38.55	33.13	11.26	57.19	68.20	-11.01	Peak	Horizontal
1	10360	30.67	38.55	33.13	11.26	47.35	54.00	-6.65	AV	Horizontal
1	10360	41.06	38.55	33.13	11.26	57.74	68.20	-10.46	Peak	Vertical
1	10360	29.66	38.55	33.13	11.26	46.34	54.00	-7.66	AV	Vertical

802.11ax20 Mode\_Channel 40\_5200 MHz

Item (Mark)	Freq (MHz)	Read Level (dB $\mu$ V)	Antenna Factor (dB/m)	PRM Factor dB	Cable Loss (dB)	Result Level (dB $\mu$ V/m)	Limit Line (dB $\mu$ V/m)	Margin (dB)	Detector	Polarization
1	10400	40.37	38.55	33.13	11.26	57.05	68.20	-11.15	Peak	Horizontal
1	10400	30.27	38.55	33.13	11.26	46.95	54.00	-7.05	AV	Horizontal
1	10400	40.39	38.55	33.13	11.26	57.07	68.20	-11.13	Peak	Vertical
1	10400	29.80	38.55	33.13	11.26	46.48	54.00	-7.52	AV	Vertical

802.11ax20 Mode\_Channel 48\_5240 MHz

Item (Mark)	Freq (MHz)	Read Level (dB $\mu$ V)	Antenna Factor (dB/m)	PRM Factor dB	Cable Loss (dB)	Result Level (dB $\mu$ V/m)	Limit Line (dB $\mu$ V/m)	Margin (dB)	Detector	Polarization
1	10480	39.04	38.55	33.13	11.26	55.72	68.20	-12.48	Peak	Horizontal
1	10480	31.79	38.55	33.13	11.26	48.47	54.00	-5.53	AV	Horizontal
1	10480	41.93	38.55	33.13	11.26	58.61	68.20	-9.59	Peak	Vertical
1	10480	28.10	38.55	33.13	11.26	44.78	54.00	-9.22	AV	Vertical

## 5260-5320MHz:

**IEEE 802.11ac HT20\_MIMO**  
**802.11ac20 Mode Channel 52\_ 5280 MHz**

Item (Mark)	Freq (MHz)	Read Level (dB $\mu$ V)	Antenna Factor (dB/m)	PRM Factor dB	Cable Loss (dB)	Result Level (dB $\mu$ V/m)	Limit Line (dB $\mu$ V/m)	Margin (dB)	Detector	Polarization
1	10520	40.27	38.55	33.13	11.26	56.95	68.20	-11.25	Peak	Horizontal
1	10520	31.61	38.55	33.13	11.26	48.29	54.00	-5.71	AV	Horizontal
1	10520	40.77	38.55	33.13	11.26	57.45	68.20	-10.75	Peak	Vertical
1	10520	29.11	38.55	33.13	11.26	45.79	54.00	-8.21	AV	Vertical

**802.11ac20 Mode Channel 56\_ 5280 MHz**

Item (Mark)	Freq (MHz)	Read Level (dB $\mu$ V)	Antenna Factor (dB/m)	PRM Factor dB	Cable Loss (dB)	Result Level (dB $\mu$ V/m)	Limit Line (dB $\mu$ V/m)	Margin (dB)	Detector	Polarization
1	10560	40.85	38.55	33.13	11.26	57.53	68.20	-10.67	Peak	Horizontal
1	10560	30.66	38.55	33.13	11.26	47.34	54.00	-6.66	AV	Horizontal
1	10560	41.80	38.55	33.13	11.26	58.48	68.20	-9.72	Peak	Vertical
1	10560	29.17	38.55	33.13	11.26	45.85	54.00	-8.15	AV	Vertical

**802.11ac20 Mode Channel 64\_ 5320 MHz**

Item (Mark)	Freq (MHz)	Read Level (dB $\mu$ V)	Antenna Factor (dB/m)	PRM Factor dB	Cable Loss (dB)	Result Level (dB $\mu$ V/m)	Limit Line (dB $\mu$ V/m)	Margin (dB)	Detector	Polarization
1	10640	40.78	38.55	33.13	11.26	57.46	68.20	-10.74	Peak	Horizontal
1	10640	31.77	38.55	33.13	11.26	48.45	54.00	-5.55	AV	Horizontal
1	10640	40.13	38.55	33.13	11.26	56.81	68.20	-11.39	Peak	Vertical
1	10640	29.08	38.55	33.13	11.26	45.76	54.00	-8.24	AV	Vertical

**IEEE 802.11ax HT20\_MIMO**  
**802.11ax20 Mode Channel 52\_ 5280 MHz**

Item (Mark)	Freq (MHz)	Read Level (dB $\mu$ V)	Antenna Factor (dB/m)	PRM Factor dB	Cable Loss (dB)	Result Level (dB $\mu$ V/m)	Limit Line (dB $\mu$ V/m)	Margin (dB)	Detector	Polarization
1	10520	39.40	38.55	33.13	11.26	56.08	68.20	-12.12	Peak	Horizontal
1	10520	31.36	38.55	33.13	11.26	48.04	54.00	-5.96	AV	Horizontal
1	10520	40.70	38.55	33.13	11.26	57.38	68.20	-10.82	Peak	Vertical
1	10520	28.19	38.55	33.13	11.26	44.87	54.00	-9.13	AV	Vertical

**802.11ax20 Mode Channel 56\_ 5280 MHz**

Item (Mark)	Freq (MHz)	Read Level (dB $\mu$ V)	Antenna Factor (dB/m)	PRM Factor dB	Cable Loss (dB)	Result Level (dB $\mu$ V/m)	Limit Line (dB $\mu$ V/m)	Margin (dB)	Detector	Polarization
1	10560	39.92	38.55	33.13	11.26	56.60	68.20	-11.60	Peak	Horizontal
1	10560	30.09	38.55	33.13	11.26	46.77	54.00	-7.23	AV	Horizontal
1	10560	41.92	38.55	33.13	11.26	58.60	68.20	-9.60	Peak	Vertical
1	10560	29.73	38.55	33.13	11.26	46.41	54.00	-7.59	AV	Vertical

**802.11ax20 Mode Channel 64\_ 5320 MHz**

Item (Mark)	Freq (MHz)	Read Level (dB $\mu$ V)	Antenna Factor (dB/m)	PRM Factor dB	Cable Loss (dB)	Result Level (dB $\mu$ V/m)	Limit Line (dB $\mu$ V/m)	Margin (dB)	Detector	Polarization
1	10640	39.01	38.55	33.13	11.26	55.69	68.20	-12.51	Peak	Horizontal
1	10640	31.34	38.55	33.13	11.26	48.02	54.00	-5.98	AV	Horizontal
1	10640	41.10	38.55	33.13	11.26	57.78	68.20	-10.42	Peak	Vertical
1	10640	28.28	38.55	33.13	11.26	44.96	54.00	-9.04	AV	Vertical

## 5500-5700MHz:

**IEEE 802.11ac HT20\_MIMO**  
**802.11ac20 Mode Channel 100\_5500 MHz**

Item (Mark)	Freq (MHz)	Read Level (dB $\mu$ V)	Antenna Factor (dB/m)	PRM Factor dB	Cable Loss (dB)	Result Level (dB $\mu$ V/m)	Limit Line (dB $\mu$ V/m)	Margin (dB)	Detector	Polarization
1	11000	39.31	38.55	33.13	11.26	55.99	68.20	-12.21	Peak	Horizontal
1	11000	31.92	38.55	33.13	11.26	48.60	54.00	-5.40	AV	Horizontal
1	11000	41.35	38.55	33.13	11.26	58.03	68.20	-10.17	Peak	Vertical
1	11000	28.32	38.55	33.13	11.26	45.00	54.00	-9.00	AV	Vertical

**802.11ac20 Mode Channel 120\_5600 MHz**

Item (Mark)	Freq (MHz)	Read Level (dB $\mu$ V)	Antenna Factor (dB/m)	PRM Factor dB	Cable Loss (dB)	Result Level (dB $\mu$ V/m)	Limit Line (dB $\mu$ V/m)	Margin (dB)	Detector	Polarization
1	11200	39.58	38.55	33.13	11.26	56.26	68.20	-11.94	Peak	Horizontal
1	11200	30.84	38.55	33.13	11.26	47.52	54.00	-6.48	AV	Horizontal
1	11200	41.94	38.55	33.13	11.26	58.62	68.20	-9.58	Peak	Vertical
1	11200	29.58	38.55	33.13	11.26	46.26	54.00	-7.74	AV	Vertical

**802.11ac20 Mode Channel 140\_5700 MHz**

Item (Mark)	Freq (MHz)	Read Level (dB $\mu$ V)	Antenna Factor (dB/m)	PRM Factor dB	Cable Loss (dB)	Result Level (dB $\mu$ V/m)	Limit Line (dB $\mu$ V/m)	Margin (dB)	Detector	Polarization
1	11400	40.09	38.55	33.13	11.26	56.77	68.20	-11.43	Peak	Horizontal
1	11400	30.27	38.55	33.13	11.26	46.95	54.00	-7.05	AV	Horizontal
1	11400	40.05	38.55	33.13	11.26	56.73	68.20	-11.47	Peak	Vertical
1	11400	28.18	38.55	33.13	11.26	44.86	54.00	-9.14	AV	Vertical

**IEEE 802.11ax HT20\_MIMO**  
**802.11ax20 Mode Channel 100\_5500 MHz**

Item (Mark)	Freq (MHz)	Read Level (dB $\mu$ V)	Antenna Factor (dB/m)	PRM Factor dB	Cable Loss (dB)	Result Level (dB $\mu$ V/m)	Limit Line (dB $\mu$ V/m)	Margin (dB)	Detector	Polarization
1	11000	39.57	38.55	33.13	11.26	56.25	68.20	-11.95	Peak	Horizontal
1	11000	30.87	38.55	33.13	11.26	47.55	54.00	-6.45	AV	Horizontal
1	11000	41.85	38.55	33.13	11.26	58.53	68.20	-9.67	Peak	Vertical
1	11000	29.66	38.55	33.13	11.26	46.34	54.00	-7.66	AV	Vertical

**802.11ax20 Mode Channel 120\_5600 MHz**

Item (Mark)	Freq (MHz)	Read Level (dB $\mu$ V)	Antenna Factor (dB/m)	PRM Factor dB	Cable Loss (dB)	Result Level (dB $\mu$ V/m)	Limit Line (dB $\mu$ V/m)	Margin (dB)	Detector	Polarization
1	11200	40.35	38.55	33.13	11.26	57.03	68.20	-11.17	Peak	Horizontal
1	11200	31.48	38.55	33.13	11.26	48.16	54.00	-5.84	AV	Horizontal
1	11200	41.72	38.55	33.13	11.26	58.40	68.20	-9.80	Peak	Vertical
1	11200	28.54	38.55	33.13	11.26	45.22	54.00	-8.78	AV	Vertical

**802.11ax20 Mode Channel 140\_5700 MHz**

Item (Mark)	Freq (MHz)	Read Level (dB $\mu$ V)	Antenna Factor (dB/m)	PRM Factor dB	Cable Loss (dB)	Result Level (dB $\mu$ V/m)	Limit Line (dB $\mu$ V/m)	Margin (dB)	Detector	Polarization
1	11400	39.32	38.55	33.13	11.26	56.00	68.20	-12.20	Peak	Horizontal
1	11400	31.91	38.55	33.13	11.26	48.59	54.00	-5.41	AV	Horizontal
1	11400	41.35	38.55	33.13	11.26	58.03	68.20	-10.17	Peak	Vertical
1	11400	28.70	38.55	33.13	11.26	45.38	54.00	-8.62	AV	Vertical

## 5725-5850MHz:

## IEEE 802.11ac HT20\_MIMO

## 802.11ac20 Mode\_Channel 149\_5745 MHz

Item (Mark)	Freq (MHz)	Read Level (dB $\mu$ V)	Antenna Factor (dB/m)	PRM Factor dB	Cable Loss (dB)	Result Level (dB $\mu$ V/m)	Limit Line (dB $\mu$ V/m)	Margin (dB)	Detector	Polarization
1	11490	40.27	38.55	33.13	11.26	56.95	68.20	-11.25	Peak	Horizontal
1	11490	31.58	38.55	33.13	11.26	48.26	54.00	-5.74	AV	Horizontal
1	11490	40.85	38.55	33.13	11.26	57.53	68.20	-10.67	Peak	Vertical
1	11490	29.72	38.55	33.13	11.26	46.40	54.00	-7.60	AV	Vertical

## 802.11ac20 Mode\_Channel 157\_5785 MHz

Item (Mark)	Freq (MHz)	Read Level (dB $\mu$ V)	Antenna Factor (dB/m)	PRM Factor dB	Cable Loss (dB)	Result Level (dB $\mu$ V/m)	Limit Line (dB $\mu$ V/m)	Margin (dB)	Detector	Polarization
1	11570	40.37	38.55	33.13	11.26	57.05	68.20	-11.15	Peak	Horizontal
1	11570	31.04	38.55	33.13	11.26	47.72	54.00	-6.28	AV	Horizontal
1	11570	40.37	38.55	33.13	11.26	57.05	68.20	-11.15	Peak	Vertical
1	11570	29.82	38.55	33.13	11.26	46.50	54.00	-7.50	AV	Vertical

## 802.11ac20 Mode\_Channel 165\_5825 MHz

Item (Mark)	Freq (MHz)	Read Level (dB $\mu$ V)	Antenna Factor (dB/m)	PRM Factor dB	Cable Loss (dB)	Result Level (dB $\mu$ V/m)	Limit Line (dB $\mu$ V/m)	Margin (dB)	Detector	Polarization
1	11650	40.40	38.55	33.13	11.26	57.08	68.20	-11.12	Peak	Horizontal
1	11650	30.49	38.55	33.13	11.26	47.17	54.00	-6.83	AV	Horizontal
1	11650	41.67	38.55	33.13	11.26	58.35	68.20	-9.85	Peak	Vertical
1	11650	28.41	38.55	33.13	11.26	45.09	54.00	-8.91	AV	Vertical

## IEEE 802.11ax HT20\_MIMO

## 802.11ax20 Mode\_Channel 149\_5745 MHz

Item (Mark)	Freq (MHz)	Read Level (dB $\mu$ V)	Antenna Factor (dB/m)	PRM Factor dB	Cable Loss (dB)	Result Level (dB $\mu$ V/m)	Limit Line (dB $\mu$ V/m)	Margin (dB)	Detector	Polarization
1	11490	39.56	38.55	33.13	11.26	56.24	68.20	-11.96	Peak	Horizontal
1	11490	31.29	38.55	33.13	11.26	47.97	54.00	-6.03	AV	Horizontal
1	11490	40.91	38.55	33.13	11.26	57.59	68.20	-10.61	Peak	Vertical
1	11490	28.71	38.55	33.13	11.26	45.39	54.00	-8.61	AV	Vertical

## 802.11ax20 Mode\_Channel 157\_5785 MHz

Item (Mark)	Freq (MHz)	Read Level (dB $\mu$ V)	Antenna Factor (dB/m)	PRM Factor dB	Cable Loss (dB)	Result Level (dB $\mu$ V/m)	Limit Line (dB $\mu$ V/m)	Margin (dB)	Detector	Polarization
1	11570	39.36	38.55	33.13	11.26	56.04	68.20	-12.16	Peak	Horizontal
1	11570	30.12	38.55	33.13	11.26	46.80	54.00	-7.20	AV	Horizontal
1	11570	41.56	38.55	33.13	11.26	58.24	68.20	-9.96	Peak	Vertical
1	11570	28.69	38.55	33.13	11.26	45.37	54.00	-8.63	AV	Vertical

## 802.11ax20 Mode\_Channel 165\_5825 MHz

Item (Mark)	Freq (MHz)	Read Level (dB $\mu$ V)	Antenna Factor (dB/m)	PRM Factor dB	Cable Loss (dB)	Result Level (dB $\mu$ V/m)	Limit Line (dB $\mu$ V/m)	Margin (dB)	Detector	Polarization
1	11650	39.23	38.55	33.13	11.26	55.91	68.20	-12.29	Peak	Horizontal
1	11650	31.83	38.55	33.13	11.26	48.51	54.00	-5.49	AV	Horizontal
1	11650	41.39	38.55	33.13	11.26	58.07	68.20	-10.13	Peak	Vertical
1	11650	28.76	38.55	33.13	11.26	45.44	54.00	-8.56	AV	Vertical

## REMARKS:

1. Result Level = Read Level + Antenna Factor + Cable loss - PRM Factor.
2. Margin = Result Level - Limit
3. The other emission levels were very low against the limit.
4. Detector AV is setting spectrum/receiver. RBW=1MHz/VBW=10Hz/Sweep time=Auto/Detector=Peak;

**NOTE: All the modes have been tested and recorded worst mode in the report(Version A\_Adapter: CYSE65-240250).**

### 4.3. Duty Cycle

#### TEST CONFIGURATION

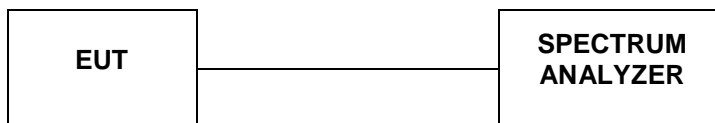

#### TEST PROCEDURE

According to KDB789033 D02 General U-NII Test Procedures New Rules v02r01 Duty Cycle (x), Transmission Duration (T):

- a. A diode detector and an oscilloscope that together have sufficiently short response time to permit accurate measurements of the on and off times of the transmitted signal
- b. The zero-span mode on a spectrum analyzer or EMI receiver, if the response time and spacing between bins on the sweep are sufficient to permit accurate measurements of the on and off times of the transmitted signal. Set the center frequency of the instrument to the center frequency of the transmission. Set  $RBW \geq EBW$  if possible; otherwise, set RBW to the largest available value. Set  $VBW \geq RBW$ . Set detector = peak or average. The zerospan measurement method shall not be used unless both RBW and VBW are  $> 50/T$ , where T is defined in section II.B.1.a), and the number of sweep points across duration T exceeds 100. (For example, if VBW and/or RBW are limited to 3 MHz, then the zero-span method of measuring duty cycle shall not be used if  $T \leq 16.7$  microseconds.)

#### TEST RESULTS

For reporting purpose only.

##### **Antenna 0:**

Please refer to Appendix C-ANT 0-Appendix D.3.

Please refer to Appendix C-ANT 0-Appendix E.3.

Please refer to Appendix C-ANT 0-Appendix F.3.

Please refer to Appendix C-ANT 0-Appendix G.3.

##### **Antenna 1:**

Please refer to Appendix C-ANT 1-Appendix D.3.

Please refer to Appendix C-ANT 1-Appendix E.3.

Please refer to Appendix C-ANT 1-Appendix F.3.

Please refer to Appendix C-ANT 1-Appendix G.3.

#### 4.4. Maximum Average Output Power

##### TEST CONFIGURATION

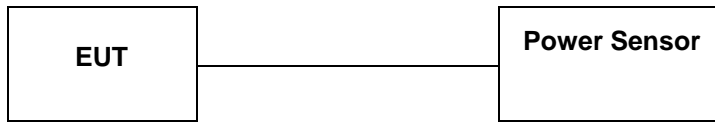

##### TEST PROCEDURE

According to KDB789033 D02 General U-NII Test Procedures New Rules v02r01 Measurement using a Power Meter (PM):

- a. Measurements may be performed using a wideband RF power meter with a thermocouple detector or equivalent if all of the conditions listed below are satisfied
  - 1. The EUT is configured to transmit continuously or to transmit with a constant duty cycle
  - 2. At all times when the EUT is transmitting, it must be transmitting at its maximum power control level.
  - 3. The integration period of the power meter exceeds the repetition period of the transmitted signal by at least a factor of five.
- b. If the transmitter does not transmit continuously, measure the duty cycle, x, of the transmitter output signal as described in section II.B
- c. Measure the average power of the transmitter. This measurement is an average over both the on and off periods of the transmitter.

Adjust the measurement in dBm by adding  $10 \log(1/x)$  where x is the duty cycle (e.g.,  $10 \log(1/0.25)$  if the duty cycle is 25 percent).

##### LIMIT

According to §15.407(a): The maximum output power should be not exceed follow:

Frequency Range (MHz)	Limit
5150-5250	Fixed: 1 Watt (30dBm) Mobile and portable: 250mW (24dBm)
5250-5350	250mW (24dBm)
5470-5725	250mW (24dBm)
5725-5850	1 Watt (30dBm)

Note: The maximum e.i.r.p at any elevation angle above 30 degrees as measured from the horizon must not exceed 125mW(21dBm)

##### TEST RESULTS

For reporting purpose only.

##### **Antenna 0:**

Please refer to Appendix C-ANT 0-Appendix D.4.

Please refer to Appendix C-ANT 0-Appendix E.4.

Please refer to Appendix C-ANT 0-Appendix F.4.

Please refer to Appendix C-ANT 0-Appendix G.4.

##### **Antenna 1:**

Please refer to Appendix C-ANT 1-Appendix D.4.

Please refer to Appendix C-ANT 1-Appendix E.4.

Please refer to Appendix C-ANT 1-Appendix F.4.

Please refer to Appendix C-ANT 1-Appendix G.4.

**MIMO\*2**  
**5150-5250MHz:**

Type	Channel	Power (dBm) ANT 0	Power (dBm) ANT 1	Total (dBm)	Limit (dBm)	Result
802.11n HT20	36	12.93	9.34	14.51	24.00	Pass
	40	13.37	10.14	15.06		
	48	9.07	12.74	14.29		
802.11n HT40	38	9.34	9.83	12.60	24.00	Pass
	46	9.69	12.79	14.52		
802.11ac20	36	7.82	11.65	13.15	24.00	Pass
	40	8.50	9.97	12.31		
	48	11.82	12.61	15.24		
802.11ac40	38	9.48	8.16	11.88	24.00	Pass
	46	12.46	11.02	14.81		
802.11ac80	42	10.10	8.57	12.41	24.00	Pass
802.11ax20	36	11.19	9.63	13.49	24.00	Pass
	40	11.98	9.98	14.10		
	48	11.48	13.25	15.46		
802.11ax40	38	10.55	9.97	13.28	24.00	Pass
	46	12.11	12.98	15.58		
802.11ax80	42	9.59	7.18	11.56	24.00	Pass

**5260-5320MHz:**

Type	Channel	Power (dBm) ANT 0	Power (dBm) ANT 1	Total (dBm)	Limit (dBm)	Result
802.11n HT20	52	12.75	12.46	15.62	24.00	Pass
	56	12.50	12.62	15.57		
	64	12.45	11.42	14.98		
802.11n HT40	54	9.16	12.48	14.14	24.00	Pass
	58	9.05	11.50	13.46		
802.11ac20	52	11.61	12.34	15.00	24.00	Pass
	56	11.12	12.60	14.93		
	64	10.91	11.54	14.25		
802.11ac40	54	12.30	10.88	14.66	24.00	Pass
	58	11.68	10.37	14.08		
802.11ac80	62	9.82	10.25	13.05	24.00	Pass
802.11ax20	52	14.24	12.98	16.67	24.00	Pass
	56	13.68	12.51	16.14		
	64	13.86	11.36	15.80		
802.11ax40	54	13.42	10.39	15.17	24.00	Pass
	58	13.64	9.93	15.18		
802.11ax80	62	12.19	9.03	13.90	24.00	Pass

## 5500-5700MHz:

Type	Channel	Power (dBm) ANT 0	Power (dBm) ANT 1	Total (dBm)	Limit (dBm)	Result
802.11n HT20	100	11.16	12.82	15.08	24.00	Pass
	120	8.47	11.65	13.36		
	140	9.88	11.41	13.72		
802.11n HT40	102	11.19	11.48	14.35	24.00	Pass
	118	8.64	10.52	12.69		
	134	7.10	9.43	11.43		
802.11ac20	100	13.83	12.81	16.36	24.00	Pass
	120	11.17	11.60	14.40		
	140	9.88	11.64	13.86		
802.11ac40	102	11.24	11.83	14.56	24.00	Pass
	118	9.57	10.95	13.32		
	134	7.81	10.61	12.44		
802.11ac80	106	10.77	7.67	12.50	24.00	Pass
	122	8.58	7.71	11.18		
802.11ax20	100	11.07	10.86	13.98	24.00	Pass
	120	10.86	10.20	13.55		
	140	9.86	8.63	12.30		
802.11ax40	102	11.51	11.86	14.70	24.00	Pass
	118	7.55	7.80	10.69		
	134	7.51	7.68	10.61		
802.11ax80	106	10.84	7.05	12.36	24.00	Pass
	122	7.00	8.22	12.73		



## 5745-5825MHz:

Type	Channel	Power (dBm) ANT 0	Power (dBm) ANT 1	Total (dBm)	Limit (dBm)	Result
802.11n HT20	149	13.83	9.23	15.12	30.00	Pass
	157	13.87	10.59	15.54		
	165	13.34	10.34	15.10		
802.11n HT40	151	9.36	7.04	11.36	30.00	Pass
	159	10.01	7.50	11.94		
802.11ac20	149	11.36	11.25	14.32	30.00	Pass
	157	12.22	11.62	14.94		
	165	12.78	11.98	15.41		
802.11ac40	151	8.87	10.05	12.51	30.00	Pass
	159	9.80	10.92	13.41		
802.11ac80	155	9.95	9.94	12.96	30.00	Pass
802.11ax20	149	8.84	10.92	13.01	30.00	Pass
	157	10.24	11.74	14.06		
	165	10.33	12.18	14.36		
802.11ax40	151	8.58	9.36	12.00	30.00	Pass
	159	9.26	9.52	12.40		
802.11ax80	155	11.16	8.46	13.03	30.00	Pass

## Remark:

The Directional Gain= Gain of individual transmit antennas (dBi) + Array gain;

Array gain =  $10 \log(N_{ant})$ , where  $N_{ant}$  is the number of transmit antennas

Directional Gain=5.01 dBi

Limit (dBm)=30dBm-(Directional Gain-6dBi)

### 4.5. Power Spectral Density

#### TEST CONFIGURATION

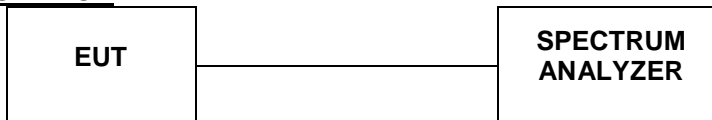

#### TEST PROCEDURE

According to KDB789033 D02 General U-NII Test Procedures New Rules v02r01: The rules requires “maximum power spectral density” measurements where the intent is to measure the maximum value of the time average of the power spectral density measured during a period of continuous transmission

- a. Create an average power spectrum for the EUT operating mode being tested by following the instructions in section II.E.2. for measuring maximum conducted output power using a spectrum analyzer or EMI receiver: select the appropriate test method (SA-1, SA-2, SA-3, or alternatives to each) and apply it up to, but not including, the step labeled, “Compute power...”. (This procedure is required even if the maximum conducted output power measurement was performed using a power meter, method PM.)
- b. Use the peak search function on the instrument to find the peak of the spectrum and record its value.
- c. Make the following adjustments to the peak value of the spectrum, if applicable:
  1. If Method SA-2 or SA-2 Alternative was used, add  $10 \log(1/x)$ , where x is the duty cycle, to the peak of the spectrum.
  2. ) If Method SA-3 Alternative was used and the linear mode was used in step II.E.2.g)(viii), add 1 dB to the final result to compensate for the difference between linear averaging and power averaging.
- d. The result is the Maximum PSD over 1 MHz reference bandwidth.
- e. For devices operating in the bands 5.15-5.25 GHz, 5.25-5.35 GHz, and 5.47-5.725 GHz, the above procedures make use of 1 MHz RBW to satisfy directly the 1 MHz reference bandwidth specified in § 15.407(a)(5). For devices operating in the band 5.725-5.85 GHz, the rules specify a measurement bandwidth of 500 kHz. Many spectrum analyzers do not have 500 kHz RBW, thus a narrower RBW may need to be used. The rules permit the use of a RBWs less than 1 MHz, or 500 kHz, “provided that the measured power is integrated over the full reference bandwidth” to show the total power over the specified measurement bandwidth (i.e., 1 MHz, or 500 kHz). If measurements are performed using a reduced resolution bandwidth (< 1 MHz, or < 500 kHz) and integrated over 1 MHz, or 500 KHz bandwidth, the following adjustments to the procedures apply:
  1. Set  $RBW \geq 1/T$ , where T is defined in section II.B.I.a).
  2. Set  $VBW \geq 3 RBW$ .
  3. If measurement bandwidth of Maximum PSD is specified in 500 kHz, add  $10\log(500kHz/RBW)$  to the measured result, whereas RBW (< 500 KHz) is the reduced resolution bandwidth of the spectrum analyzer set during measurement.
  4. If measurement bandwidth of Maximum PSD is specified in 1 MHz, add  $10\log(1MHz/RBW)$  to the measured result, whereas RBW (< 1 MHz) is the reduced resolution bandwidth of spectrum analyzer set during measurement.
  5. Care must be taken to ensure that the measurements are performed during a period of continuous transmission or are corrected upward for duty cycle.

Note: As a practical matter, it is recommended to use reduced RBW of 100 KHz for the sections 5.c) and 5.d) above, since  $RBW=100 KHz$  is available on nearly all spectrum analyzers.
- f. Adjust the measurement in dBm by adding  $10 \log(1/x)$  where x is the duty cycle (e.g.,  $10 \log(1/0.25)$  if the duty cycle is 25 percent).

#### LIMIT

According to §15.407(a): The maximum output power should be not exceed follow:

Frequency Range (MHz)	Limit
5150-5250	Other then Mobile and portable:17dBm/MHz Mobile and portable:11dBm/MHz
5250-5350	11dBm/MHz
5470-5725	11dBm/MHz
5725-5850	30dBm/500kHz

**TEST RESULTS**

For reporting purpose only.

**Antenna 0:**

Please refer to Appendix C-ANT 0-Appendix D.5.

Please refer to Appendix C-ANT 0-Appendix E.5.

Please refer to Appendix C-ANT 0-Appendix F.5.

Please refer to Appendix C-ANT 0-Appendix G.5.

**Antenna 1:**

Please refer to Appendix C-ANT 1-Appendix D.5.

Please refer to Appendix C-ANT 1-Appendix E.5.

Please refer to Appendix C-ANT 1-Appendix F.5.

Please refer to Appendix C-ANT 1-Appendix G.5.

## MIMO\*2

## 5150-5250MHz:

Type	Channel	PSD (dBm/1MHz) ANT 0	PSD (dBm/1MHz ) ANT 1	Total (dBm/1MHz )	Limit (dBm/1MHz )	Result
802.11n HT20	36	1.89	-1.65	3.48	11.00	Pass
	40	2.35	-0.77	4.07		
	48	5.19	1.93	6.87		
802.11n HT40	38	-6.25	-3.71	-1.79	11.00	Pass
	46	-3.08	-0.68	1.29		
802.11ac 20	36	-3.86	0.61	1.94	11.00	Pass
	40	-3.19	-1.03	1.03		
	48	0.35	1.79	4.14		
802.11ac 40	38	-4.41	-4.7	-1.54	11.00	Pass
	46	-1.29	-1.75	1.50		
802.11ac 80	42	-6.42	-6.93	-3.66	11.00	Pass
802.11ax 20	36	-0.69	-1.79	1.81	11.00	Pass
	40	0.02	-1.46	2.35		
	48	2.91	1.95	5.47		
802.11ax 40	38	-3.61	-4.06	-0.82	11.00	Pass
	46	-0.04	-1.05	2.49		
802.11ax 80	42	-7.25	-9.66	-5.28	11.00	Pass

## 5260-5320MHz:

Type	Channel	PSD (dBm/1MHz) ANT 0	PSD (dBm/1MHz ) ANT 1	Total (dBm/1MHz )	Limit (dBm/1MHz )	Result
802.11n HT20	52	4.84	1.69	6.55	11.00	Pass
	56	4.59	1.84	6.44		
	64	4.61	0.83	6.13		
802.11n HT40	54	-3.61	-0.99	0.90	11.00	Pass
	58	-3.7	-2.03	0.23		
802.11ac 20	52	-0.16	1.5	3.76	11.00	Pass
	56	-0.6	1.68	3.70		
	64	-0.68	0.61	3.02		
802.11ac 40	54	-1.65	-1.84	1.27	11.00	Pass
	58	-2.05	-2.16	0.91		
802.11ac 80	62	-6.86	-5.56	-3.15	11.00	Pass
802.11ax 20	52	2.46	1.72	5.12	11.00	Pass
	56	1.8	1.2	4.52		
	64	2.11	0.09	4.23		
802.11ax 40	54	-0.83	-3.89	0.91	11.00	Pass
	58	-0.65	-4.18	0.94		
802.11ax 80	62	-5.02	-8.26	-3.33	11.00	Pass

## 5500-5700MHz:

Type	Channel	PSD (dBm/1MHz) ANT 0	PSD (dBm/1MHz ) ANT 1	Total (dBm/1MHz )	Limit (dBm/1MHz )	Result
802.11n HT20	100	0.02	1.58	3.88	11.00	Pass
	120	-2.53	0.58	2.31		
	140	-1.23	0.33	2.63		
802.11n HT40	102	-2.59	-1.23	1.15	11.00	Pass
	118	-5	-3.15	-0.97		
	134	-6.36	-4.38	-2.25		
802.11ac 20	100	2.49	1.49	5.03	11.00	Pass
	120	-0.07	0.29	3.12		
	140	-1.41	0.47	2.64		
802.11ac 40	102	-1.46	-1.03	1.77	11.00	Pass
	118	-3.09	-1.8	0.61		
	134	-4.86	-2.12	-0.27		
802.11ac 80	106	-4.17	-7.76	-2.59	11.00	Pass
	122	-6.74	-8.85	-4.66		
802.11ax 20	100	2.35	-0.82	4.06	11.00	Pass
	120	-0.74	-1.44	1.93		
	140	-1.73	-2.93	0.72		
802.11ax 40	102	-2.95	-2.43	0.33	11.00	Pass
	118	-6.46	-6.41	-3.42		
	134	-9.94	-7.68	-5.65		
802.11ax 80	106	-5.78	-9.46	-4.23	11.00	Pass
	122	-10.04	-8.26	-3.84		

## 5725-5850MHz:

Type	Channel	PSD (dBm/500KHz) ANT 0	PSD (dBm/500KHz) ANT 1	Total (dBm/500KHz)	Limit (dBm/500KHz)	Result
802.11 n HT20	149	0.01	-4.26	1.39	30.00	Pass
	157	1.04	-2.85	2.53		
	165	1.58	-3.14	2.84		
802.11 n HT40	151	-5.46	-8.26	-3.63	30.00	Pass
	159	-4.53	-7.89	-2.88		
802.11 ac20	149	-2.88	-2.24	0.46	30.00	Pass
	157	-1.6	-1.73	1.35		
	165	-1.38	-1.35	1.65		
802.11 ac40	151	-6.86	-4.64	-2.60	30.00	Pass
	159	-5.75	-3.77	-1.64		
802.11 ac80	155	-10.11	-7.33	-5.49	30.00	Pass
802.11 ax20	149	-5.02	-2.8	-0.76	30.00	Pass
	157	-3.77	-1.81	0.33		
	165	-3.61	-1.31	0.70		
802.11 ax40	151	-6.76	-6.6	-3.67	30.00	Pass
	159	-6.75	-6.16	-3.43		
802.11 ax80	155	-7.63	-10.42	-5.79	30.00	Pass

## Remark:

The Directional Gain= Gain of individual transmit antennas (dBi) + Array gain;

Array gain =  $10 \log(\text{Nant})$ , where Nant is the number of transmit antennas

Directional Gain=5.01 dBi

Limit (dBm)=30dBm-(Directional Gain-6dBi)

## 4.6. 99% and 6dB Bandwidth

### TEST CONFIGURATION

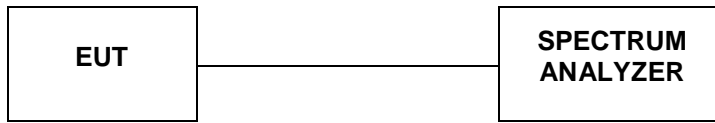

### TEST PROCEDURE

According to KDB789033 D02 General U-NII Test Procedures New Rules v02r01 for one of the following procedures may be used for section 15.407(e) specifies the minimum 6 dB emission bandwidth of at least 500 KHz for the band 5.715-5.85 GHz. The following procedure shall be used for measuring this bandwidth:

- a. Set RBW = 100 kHz.
- b. Set the video bandwidth (VBW)  $\geq 3 \times$  RBW
- c. Detector = Peak.
- d. Trace mode = max hold.
- e. Sweep = auto couple.
- f. Allow the trace to stabilize
- g. Measure the maximum width of the emission that is constrained by the frequencies associated with the two outermost amplitude points (upper and lower frequencies) that are attenuated by 6 dB relative to the maximum level measured in the fundamental emission.

Note: The automatic bandwidth measurement capability of a spectrum analyzer or EMI receiver may be employed if it implements the functionality described above.

### LIMIT

For Section 15.407(e) specifies the minimum 6 dB emission bandwidth of at least 500 KHz for the band 5.715-5.85 GHz

### TEST RESULTS

For reporting purpose only.

#### **Antenna 0:**

Please refer to Appendix C-ANT 0-Appendix G.1.

Please refer to Appendix C-ANT 0-Appendix G.2.

#### **Antenna 1:**

Please refer to Appendix C-ANT 1-Appendix G.1.

Please refer to Appendix C-ANT 1-Appendix G.2.



## 4.7. 99% and 26dBc Bandwidth

### TEST CONFIGURATION

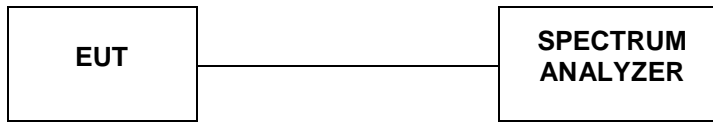

### TEST PROCEDURE

According to KDB789033 D02 General U-NII Test Procedures New Rules v02r01 for one of the following procedures may be used for Emission Bandwidth (EBW) measurement:

- Set RBW = 220 kHz/430 kHz /820 kHz (approximately 1% of the emission bandwidth).
- Set the video bandwidth (VBW) = 3\* RBW)
- Detector = Peak.
- Trace mode = max hold.
- Sweep = auto couple.
- Allow the trace to stabilize
- Measure the maximum width of the emission that is 26 dB down from the maximum of the emission. Compare this with the RBW setting of the analyzer. Readjust RBW and repeat measurement as needed until the RBW/EBW ratio is approximately 1%.

Note: The automatic bandwidth measurement capability of a spectrum analyzer or EMI receiver may be employed if it implements the functionality described above.

### LIMIT

No Limits for 26dBc Bandwidth

### TEST RESULTS

For reporting purpose only.

#### **Antenna 0:**

Please refer to Appendix C-ANT 0-Appendix D.1.

Please refer to Appendix C-ANT 0-Appendix E.1.

Please refer to Appendix C-ANT 0-Appendix F.1.

Please refer to Appendix C-ANT 0-Appendix D.2.

Please refer to Appendix C-ANT 0-Appendix E.2.

Please refer to Appendix C-ANT 0-Appendix F.2.

#### **Antenna 1:**

Please refer to Appendix C-ANT 1-Appendix D.1.

Please refer to Appendix C-ANT 1-Appendix E.1.

Please refer to Appendix C-ANT 1-Appendix F.1.

Please refer to Appendix C-ANT 1-Appendix D.2.

Please refer to Appendix C-ANT 1-Appendix E.2.

Please refer to Appendix C-ANT 1-Appendix F.2.

### 4.8. Conducted Spurious Emissions and Band Edge Compliance

#### TEST CONFIGURATION

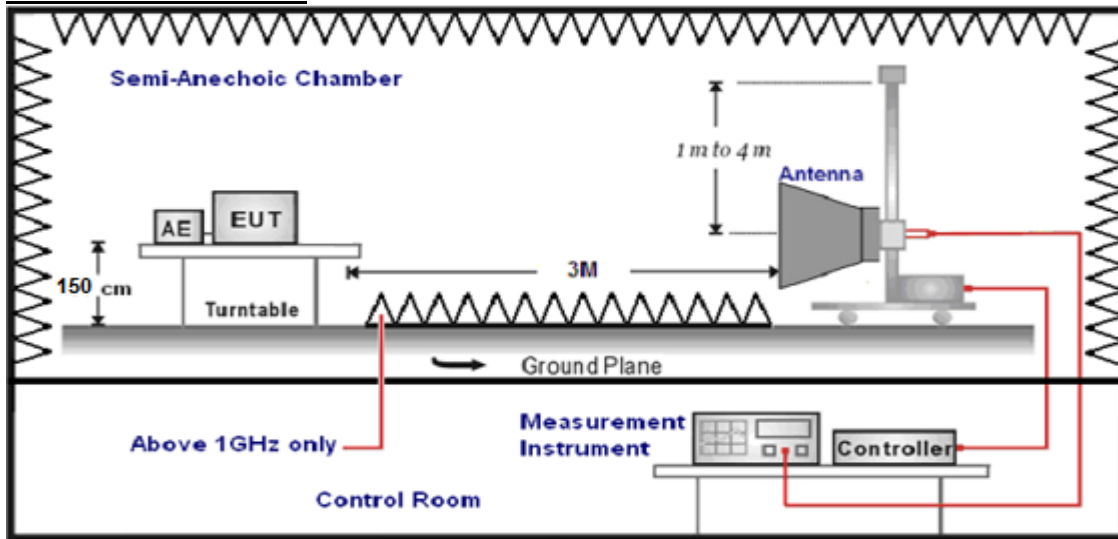

#### LIMIT

20dBc in any 100 kHz bandwidth outside the operating frequency band. In case the emission fall within the restricted band specified on 15.205(a), then the 15.209(a) limit in the table below has to be followed.

Frequency (MHz)	Distance (Meters)	Radiated (dBµV/m)	Radiated (µV/m)
0.009-0.49	3	$20\log(2400/F(KHz))+40\log(300/3)$	$2400/F(KHz)$
0.49-1.705	3	$20\log(24000/F(KHz))+40\log(30/3)$	$24000/F(KHz)$
1.705-30	3	$20\log(30)+40\log(30/3)$	30
30-88	3	40.0	100
88-216	3	43.5	150
216-960	3	46.0	200
Above 960	3	54.0	500

According to §15.407 (b): Except as shown in paragraph (b)(7) of this section, the maximum emissions outside of the frequency bands of operation shall be attenuated in accordance with the following limits

Frequency (MHz)	EIRP Limit (dBm)	Equivalent Field Strength at 3m (dBµV/m)
5150-5250	-27	68.2
5250-5350	-27	68.2
5470-5725	-27	68.2
5725-5850	-27 (beyond 10MHz of the bandedge)	68.2
	-17 (within 10 MHz of band edge)	78.2

#### TEST PROCEDURE

- The EUT was placed on a turn table which is 1.5m above 1GHz.
- Maximum procedure was performed by raising the receiving antenna from 1m to 4m and rotating the turn table from 0° to 360° to acquire the highest emissions from EUT.
- And also, each emission was to be maximized by changing the polarization of receiving antenna both horizontal and vertical.
- Repeat above procedures until all frequency measurements have been completed..
- The distance between test antenna and EUT as following table states:

Test Frequency range	Test Antenna Type	Test Distance
1GHz-18GHz	Double Ridged Horn Antenna	3

- Setting test receiver/spectrum as following table states:

Test Frequency range	Test Receiver/Spectrum Setting	Detector
1GHz-18GHz	Peak Value: RBW=1MHz/VBW=3MHz, Sweep time=Auto Average Value: RBW=1MHz/VBW=10Hz, Sweep time=Auto	Peak

**Field Strength Calculation**

The field strength is calculated by adding the Antenna Factor and Cable Factor and subtracting the Amplifier Gain and Duty Cycle Correction Factor(if any) from the measured reading. The basic equation with a sample calculation is as follows:

$$FS = RA + AF + CL - AG$$

Where FS = Field Strength	CL = Cable Attenuation Factor (Cable Loss)
RA = Reading Amplitude	AG = Amplifier Gain
AF = Antenna Factor	

**TEST RESULTS**

Remark:For radiated bandedge We measured at both mode, recorded worst case in antenna 0's 802.11 ac20 mode;

**For Radiated Bandedge Measurement**

Temperature	23.4°C	Humidity	54.5%
Test Engineer	Evan Ouyang	Configurations	IEEE 802.11a/n/ac

802.11 ac20/ Channel 36 :5180 MHz									
Freq (MHz)	Read Level (dBµV)	Antenna Factor (dB/m)	PRM Factor (dB)	Cable Loss (dB)	Result Level (dBµV/m)	Limit Line (dBµV/m)	Margin (dB)	Detector	Polarization
4500.0	35.25	35.58	29.04	8.28	50.07	68.20	-18.13	Peak	Horizontal
4500.0	30.13	35.58	29.04	8.28	44.95	54.00	-9.05	AV	Horizontal
5150.0	39.12	35.58	29.04	8.28	53.94	68.20	-14.26	Peak	Horizontal
5150.0	30.50	35.58	29.04	8.28	45.32	54.00	-8.68	AV	Horizontal

802.11 ac20/ Channel 36 :5180 MHz									
Freq (MHz)	Read Level (dBµV)	Antenna Factor (dB/m)	PRM Factor (dB)	Cable Loss (dB)	Result Level (dBµV/m)	Limit Line (dBµV/m)	Margin (dB)	Detector	Polarization
4500.0	35.15	35.58	29.04	8.28	49.97	68.20	-18.23	Peak	Vertical
4500.0	30.09	35.58	29.04	8.28	44.91	54.00	-9.09	AV	Vertical
5150.0	39.06	35.58	29.04	8.28	53.88	68.20	-14.32	Peak	Vertical
5150.0	30.53	35.58	29.04	8.28	45.35	54.00	-8.65	AV	Vertical

802.11 ac20/ Channel 48 :5240 MHz									
Freq (MHz)	Read Level (dBµV)	Antenna Factor (dB/m)	PRM Factor (dB)	Cable Loss (dB)	Result Level (dBµV/m)	Limit Line (dBµV/m)	Margin (dB)	Detector	Polarization
5350.0	35.15	35.42	29.06	8.39	49.90	68.20	-18.30	Peak	Horizontal
5350.0	30.29	35.42	29.06	8.39	45.04	54.00	-8.96	AV	Horizontal
5460.0	39.05	35.42	29.06	8.39	53.80	68.20	-14.40	Peak	Horizontal
5460.0	30.59	35.42	29.06	8.39	45.34	54.00	-8.66	AV	Horizontal

802.11 ac20/ Channel 48 :5240 MHz									
Freq (MHz)	Read Level (dBµV)	Antenna Factor (dB/m)	PRM Factor (dB)	Cable Loss (dB)	Result Level (dBµV/m)	Limit Line (dBµV/m)	Margin (dB)	Detector	Polarization
5350.0	35.24	35.42	29.06	8.39	49.99	68.20	-18.21	Peak	Vertical
5350.0	30.17	35.42	29.06	8.39	44.92	54.00	-9.08	AV	Vertical
5460.0	39.23	35.42	29.06	8.39	53.98	68.20	-14.22	Peak	Vertical
5460.0	30.64	35.42	29.06	8.39	45.39	54.00	-8.61	AV	Vertical

802.11 a/ Channel 52 :5260 MHz									
Freq (MHz)	Read Level (dBμV)	Antenna Factor (dB/m)	PRM Factor (dB)	Cable Loss (dB)	Result Level (dBμV/m)	Limit Line (dBμV/m)	Margin (dB)	Detector	Polarization
4500.0	30.08	35.35	29.07	8.43	44.79	68.20	-23.41	Peak	Horizontal
4500.0	30.29	35.35	29.07	8.43	45.00	54.00	-9.00	AV	Horizontal
5150.0	32.26	35.35	29.07	8.43	46.97	68.20	-21.23	Peak	Horizontal
5150.0	30.52	35.35	29.07	8.43	45.23	54.00	-8.77	AV	Horizontal

802.11 a/ Channel 52 :5260 MHz									
Freq (MHz)	Read Level (dBμV)	Antenna Factor (dB/m)	PRM Factor (dB)	Cable Loss (dB)	Result Level (dBμV/m)	Limit Line (dBμV/m)	Margin (dB)	Detector	Polarization
4500.0	30.12	35.35	29.07	8.43	44.83	68.20	-23.37	Peak	Vertical
4500.0	30.40	35.35	29.07	8.43	45.11	54.00	-8.89	AV	Vertical
5150.0	32.09	35.35	29.07	8.43	46.80	68.20	-21.40	Peak	Vertical
5150.0	30.54	35.35	29.07	8.43	45.25	54.00	-8.75	AV	Vertical

802.11 a/ Channel 64 :5320 MHz									
Freq (MHz)	Read Level (dBμV)	Antenna Factor (dB/m)	PRM Factor (dB)	Cable Loss (dB)	Result Level (dBμV/m)	Limit Line (dBμV/m)	Margin (dB)	Detector	Polarization
5350.0	30.12	35.3	29.11	8.51	44.82	68.20	-23.38	Peak	Horizontal
5350.0	30.16	35.3	29.11	8.51	44.86	54.00	-9.14	AV	Horizontal
5460.0	32.16	35.3	29.11	8.51	46.86	68.20	-21.34	Peak	Horizontal
5460.0	30.59	35.3	29.11	8.51	45.29	54.00	-8.71	AV	Horizontal

802.11 a/ Channel 64 :5320 MHz									
Freq (MHz)	Read Level (dBμV)	Antenna Factor (dB/m)	PRM Factor (dB)	Cable Loss (dB)	Result Level (dBμV/m)	Limit Line (dBμV/m)	Margin (dB)	Detector	Polarization
5350.0	30.22	35.3	29.11	8.51	44.92	68.20	-23.28	Peak	Vertical
5350.0	30.29	35.3	29.11	8.51	44.99	54.00	-9.01	AV	Vertical
5460.0	32.24	35.3	29.11	8.51	46.94	68.20	-21.26	Peak	Vertical
5460.0	30.64	35.3	29.11	8.51	45.34	54.00	-8.66	AV	Vertical

802.11 a/ Channel 100 :5500 MHz									
Freq (MHz)	Read Level (dBμV)	Antenna Factor (dB/m)	PRM Factor (dB)	Cable Loss (dB)	Result Level (dBμV/m)	Limit Line (dBμV/m)	Margin (dB)	Detector	Polarization
5460.0	30.27	35.29	29.13	8.65	45.08	68.20	-23.12	Peak	Horizontal
5460.0	30.14	35.29	29.13	8.65	44.95	54.00	-9.05	AV	Horizontal
5470.0	32.01	35.29	29.13	8.65	46.82	68.20	-21.38	Peak	Horizontal
5470.0	30.56	35.29	29.13	8.65	45.37	54.00	-8.63	AV	Horizontal

802.11 a/ Channel 100 :5500 MHz									
Freq (MHz)	Read Level (dBμV)	Antenna Factor (dB/m)	PRM Factor (dB)	Cable Loss (dB)	Result Level (dBμV/m)	Limit Line (dBμV/m)	Margin (dB)	Detector	Polarization
5460.0	30.03	35.29	29.13	8.65	44.84	68.20	-23.36	Peak	Vertical
5460.0	30.19	35.29	29.13	8.65	45.00	54.00	-9.00	AV	Vertical
5470.0	32.27	35.29	29.13	8.65	47.08	68.20	-21.12	Peak	Vertical
5470.0	30.67	35.29	29.13	8.65	45.48	54.00	-8.52	AV	Vertical

802.11 a/ Channel 140 :5700 MHz									
Freq (MHz)	Read Level (dBμV)	Antenna Factor (dB/m)	PRM Factor (dB)	Cable Loss (dB)	Result Level (dBμV/m)	Limit Line (dBμV/m)	Margin (dB)	Detector	Polarization
5725.0	30.24	35.29	29.18	8.8	45.15	68.20	-23.05	Peak	Horizontal
5725.0	30.41	35.29	29.18	8.8	45.32	54.00	-8.68	AV	Horizontal
5735.0	32.03	35.29	29.18	8.8	46.94	68.20	-21.26	Peak	Horizontal
5735.0	30.72	35.29	29.18	8.8	45.63	54.00	-8.37	AV	Horizontal

802.11 a/ Channel 140 :5700 MHz									
Freq (MHz)	Read Level (dBµV)	Antenna Factor (dB/m)	PRM Factor (dB)	Cable Loss (dB)	Result Level (dBµV/m)	Limit Line (dBµV/m)	Margin (dB)	Detector	Polarization
5725.0	30.25	35.29	29.18	8.8	45.16	68.20	-23.04	Peak	Vertical
5725.0	30.18	35.29	29.18	8.8	45.09	54.00	-8.91	AV	Vertical
5735.0	32.04	35.29	29.18	8.8	46.95	68.20	-21.25	Peak	Vertical
5735.0	30.73	35.29	29.18	8.8	45.64	54.00	-8.36	AV	Vertical

802.11 ac20/ Channel 149 :5745 MHz									
Freq (MHz)	Read Level (dBµV)	Antenna Factor (dB/m)	PRM Factor (dB)	Cable Loss (dB)	Result Level (dBµV/m)	Limit Line (dBµV/m)	Margin (dB)	Detector	Polarization
5650.0	45.89	35.29	29.18	8.8	60.80	68.20	-7.40	Peak	Horizontal
5700.0	35.10	35.29	29.18	8.8	50.01	68.20	-18.19	Peak	Horizontal
5720.0	46.98	35.29	29.18	8.8	61.89	68.20	-6.31	Peak	Horizontal
5725.0	35.66	35.29	29.18	8.8	50.57	68.20	-17.63	Peak	Horizontal

802.11 ac20/ Channel 149 :5745 MHz									
Freq (MHz)	Read Level (dBµV)	Antenna Factor (dB/m)	PRM Factor (dB)	Cable Loss (dB)	Result Level (dBµV/m)	Limit Line (dBµV/m)	Margin (dB)	Detector	Polarization
5650.0	45.95	35.29	29.18	8.8	60.86	68.20	-7.34	Peak	Vertical
5700.0	34.92	35.29	29.18	8.8	49.83	68.20	-18.37	Peak	Vertical
5720.0	47.19	35.29	29.18	8.8	62.10	68.20	-6.10	Peak	Vertical
5725.0	35.79	35.29	29.18	8.8	50.70	68.20	-17.50	Peak	Vertical

802.11 ac20/ Channel 165 :5825 MHz									
Freq (MHz)	Read Level (dBµV)	Antenna Factor (dB/m)	PRM Factor (dB)	Cable Loss (dB)	Result Level (dBµV/m)	Limit Line (dBµV/m)	Margin (dB)	Detector	Polarization
5850.0	46.18	33.21	35.82	9.52	53.09	68.20	-15.11	Peak	Horizontal
5855.0	35.53	33.21	35.82	9.52	42.44	68.20	-25.76	Peak	Horizontal
5875.0	47.17	32.82	35.82	9.52	53.69	68.20	-14.51	Peak	Horizontal
5925.0	35.79	32.82	35.82	9.52	42.31	68.20	-25.89	Peak	Horizontal

802.11 ac20/ Channel 165 :5825 MHz									
Freq (MHz)	Read Level (dBµV)	Antenna Factor (dB/m)	PRM Factor (dB)	Cable Loss (dB)	Result Level (dBµV/m)	Limit Line (dBµV/m)	Margin (dB)	Detector	Polarization
5850.0	45.92	33.21	35.82	9.52	52.83	68.20	-15.37	Peak	Vertical
5855.0	35.39	33.21	35.82	9.52	42.30	68.20	-25.90	Peak	Vertical
5875.0	47.20	32.82	35.82	9.52	53.72	68.20	-14.48	Peak	Vertical
5925.0	35.79	32.82	35.82	9.52	42.31	68.20	-25.89	Peak	Vertical

REMARKS:

1. Result Level = Read Level + Antenna Factor + Cable loss - PRM Factor.
2. Margin value = Result Level-Limit value.
2. The other emission levels were very low against the limit.
3. The average measurement was not performed when the peak measured data under the limit of average detection.
4. Detector AV is setting spectrum/receiver. RBW=1MHz/VBW=10Hz/Sweep time=Auto/Detector=Peak;

**NOTE: All the modes have been tested and recorded worst mode in the report(Version A\_Adapter: CYSE65-240250).**

**For Conducted Band edge Measurement**

For reporting purpose only.

**Antenna 0:**

Please refer to Appendix C-ANT 0-Appendix D.6.

Please refer to Appendix C-ANT 0-Appendix E.6.

Please refer to Appendix C-ANT 0-Appendix F.6.

Please refer to Appendix C-ANT 0-Appendix G.6.

**Antenna 1:**

Please refer to Appendix C-ANT 1-Appendix D.6.

Please refer to Appendix C-ANT 1-Appendix E.6.

Please refer to Appendix C-ANT 1-Appendix F.6.

Please refer to Appendix C-ANT 1-Appendix G.6.

**For Conducted Spurious Emissions Measurement**

For reporting purpose only.

**Antenna 0:**

Please refer to Appendix C-ANT 0-Appendix D.7.

Please refer to Appendix C-ANT 0-Appendix E.7.

Please refer to Appendix C-ANT 0-Appendix F.7.

Please refer to Appendix C-ANT 0-Appendix G.7.

**Antenna 1:**

Please refer to Appendix C-ANT 1-Appendix D.7.

Please refer to Appendix C-ANT 1-Appendix E.7.

Please refer to Appendix C-ANT 1-Appendix F.7.

Please refer to Appendix C-ANT 1-Appendix G.7.

## 4.9. Frequency Stability

### Standard Applicable

According to FCC §15.407(g) “Manufacturers of U-NII devices are responsible for ensuring frequency stability such that an emission is maintained within the band of operation under all conditions of normal operation as specified in the user manual.”

According to FCC §2.1055(a) “The frequency stability shall be measured with variation of ambient temperature as follows:”

(1) From  $-30^{\circ}$  to  $+50^{\circ}$  centigrade for all equipment except that specified in paragraphs (a) (2) and (3) of this section.

(2) From  $-20^{\circ}$  to  $+50^{\circ}$  centigrade for equipment to be licensed for use in the Maritime Services under part 80 of this chapter, except for Class A, B, and S Emergency Position Indicating Radiobeacons (EPIRBS), and equipment to be licensed for use above 952 MHz at operational fixed stations in all services, stations in the Local Television Transmission Service and Point-to-Point Microwave Radio Service under part 21 of this chapter, equipment licensed for use aboard aircraft in the Aviation Services under part 87 of this chapter, and equipment authorized for use in the Family Radio Service under part 95 of this chapter.

(3) From  $0^{\circ}$  to  $+50^{\circ}$  centigrade for equipment to be licensed for use in the Radio Broadcast Services under part 73 of this chapter.

### Test Configuration

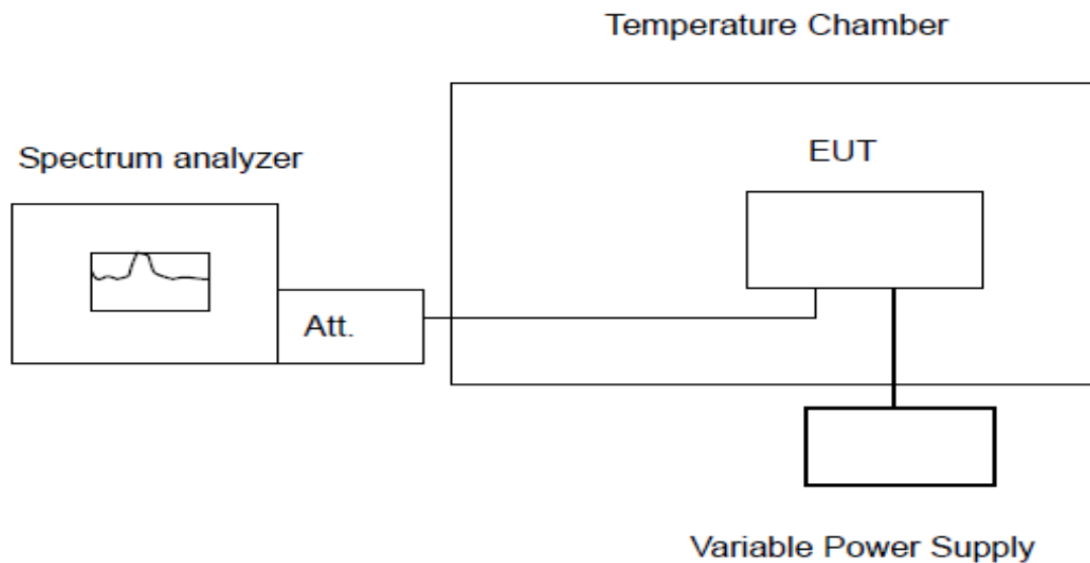

### Test Procedure

The equipment under test was connected to an external AC or DC power supply and input rated voltage. RF output was connected to a frequency counter or spectrum analyzer via feed through attenuators. The EUT was placed inside the temperature chamber. Set the spectrum analyzer RBW low enough to obtain the desired frequency resolution and measure EUT 20 degree operating frequency as reference frequency. Turn EUT off and set the chamber temperature to  $-30$  degree. After the temperature stabilized for approximately 30 minutes recorded the frequency. Repeat step measure with 10 degree increased per stage until the highest temperature of  $+50$  degree reached.

**Test Results**

PASS

Remark:

1. Measured all conditions and recorded worst case.

IEEE 802.11a Mode / 5180 – 5240 MHz / 5180 MHz

Environment Temperature (Degree)	Voltage (V)	Measured Frequency (MHz)	Limit Range (MHz)	Test Results
20	DC 26.4V	5171.629255	5150 – 5250	PASS
20	DC 21.6V	5171.574791	5150 – 5250	PASS
50	DC 24.0V	5171.536943	5150 – 5250	PASS
40	DC 24.0V	5171.663897	5150 – 5250	PASS
30	DC 24.0V	5171.576904	5150 – 5250	PASS
20	DC 24.0V	5171.575600	5150 – 5250	PASS
10	DC 24.0V	5171.502811	5150 – 5250	PASS
0	DC 24.0V	5171.550690	5150 – 5250	PASS
-10	DC 24.0V	5171.647721	5150 – 5250	PASS
-20	DC 24.0V	5171.601182	5150 – 5250	PASS
-30	DC 24.0V	5171.543441	5150 – 5250	PASS

IEEE 802.11a Mode / 5180 – 5240 MHz / 5240 MHz

Environment Temperature (Degree)	Voltage (V)	Measured Frequency (MHz)	Limit Range (MHz)	Test Results
20	DC 26.4V	5248.563680	5150 – 5250	PASS
20	DC 21.6V	5248.639740	5150 – 5250	PASS
50	DC 24.0V	5248.641325	5150 – 5250	PASS
40	DC 24.0V	5248.512211	5150 – 5250	PASS
30	DC 24.0V	5248.699666	5150 – 5250	PASS
20	DC 24.0V	5248.688278	5150 – 5250	PASS
10	DC 24.0V	5248.583934	5150 – 5250	PASS
0	DC 24.0V	5248.629025	5150 – 5250	PASS
-10	DC 24.0V	5248.556321	5150 – 5250	PASS
-20	DC 24.0V	5248.684074	5150 – 5250	PASS
-30	DC 24.0V	5248.526484	5150 – 5250	PASS



## IEEE 802.11a Mode / 5260 – 5320 MHz / 5260 MHz

Environment Temperature (Degree)	Voltage (V)	Measured Frequency (MHz)	Limit Range (MHz)	Test Results
20	DC 26.4V	5251.560215	5250 – 5350	PASS
20	DC 21.6V	5251.687324	5250 – 5350	PASS
50	DC 24.0V	5251.602747	5250 – 5350	PASS
40	DC 24.0V	5251.642634	5250 – 5350	PASS
30	DC 24.0V	5251.579278	5250 – 5350	PASS
20	DC 24.0V	5251.663476	5250 – 5350	PASS
10	DC 24.0V	5251.574768	5250 – 5350	PASS
0	DC 24.0V	5251.510915	5250 – 5350	PASS
-10	DC 24.0V	5251.522259	5250 – 5350	PASS
-20	DC 24.0V	5251.662242	5250 – 5350	PASS
-30	DC 24.0V	5251.531787	5250 – 5350	PASS

## IEEE 802.11a Mode / 5260 – 5320 MHz / 5320 MHz

Environment Temperature (Degree)	Voltage (V)	Measured Frequency (MHz)	Limit Range (MHz)	Test Results
20	DC 26.4V	5328.686671	5250 – 5350	PASS
20	DC 21.6V	5328.648113	5250 – 5350	PASS
50	DC 24.0V	5328.635164	5250 – 5350	PASS
40	DC 24.0V	5328.595685	5250 – 5350	PASS
30	DC 24.0V	5328.501610	5250 – 5350	PASS
20	DC 24.0V	5328.503756	5250 – 5350	PASS
10	DC 24.0V	5328.537208	5250 – 5350	PASS
0	DC 24.0V	5328.661008	5250 – 5350	PASS
-10	DC 24.0V	5328.627057	5250 – 5350	PASS
-20	DC 24.0V	5328.594846	5250 – 5350	PASS
-30	DC 24.0V	5328.664623	5250 – 5350	PASS

## IEEE 802.11a Mode / 5500 – 5700 MHz / 5500 MHz

Environment Temperature (Degree)	Voltage (V)	Measured Frequency (MHz)	Limit Range (MHz)	Test Results
20	DC 26.4V	5491.624570	5470 – 5725	PASS
20	DC 21.6V	5491.683192	5470 – 5725	PASS
50	DC 24.0V	5491.679316	5470 – 5725	PASS
40	DC 24.0V	5491.649705	5470 – 5725	PASS
30	DC 24.0V	5491.538644	5470 – 5725	PASS
20	DC 24.0V	5491.535626	5470 – 5725	PASS
10	DC 24.0V	5491.549169	5470 – 5725	PASS
0	DC 24.0V	5491.518846	5470 – 5725	PASS
-10	DC 24.0V	5491.515172	5470 – 5725	PASS
-20	DC 24.0V	5491.626893	5470 – 5725	PASS
-30	DC 24.0V	5491.699718	5470 – 5725	PASS

IEEE 802.11a Mode / 5500 – 5700 MHz / 5700 MHz

Environment Temperature (Degree)	Voltage (V)	Measured Frequency (MHz)	Limit Range (MHz)	Test Results
20	DC 26.4V	5708.509988	5470 – 5725	PASS
20	DC 21.6V	5708.567456	5470 – 5725	PASS
50	DC 24.0V	5708.691345	5470 – 5725	PASS
40	DC 24.0V	5708.665815	5470 – 5725	PASS
30	DC 24.0V	5708.516122	5470 – 5725	PASS
20	DC 24.0V	5708.585852	5470 – 5725	PASS
10	DC 24.0V	5708.532277	5470 – 5725	PASS
0	DC 24.0V	5708.693336	5470 – 5725	PASS
-10	DC 24.0V	5708.580788	5470 – 5725	PASS
-20	DC 24.0V	5708.697472	5470 – 5725	PASS
-30	DC 24.0V	5708.504930	5470 – 5725	PASS

IEEE 802.11a Mode / 5745 – 5825 MHz / 5745 MHz

Environment Temperature (Degree)	Voltage (V)	Measured Frequency (MHz)	Limit Range (MHz)	Test Results
20	DC 26.4V	5736.572831	5725 – 5850	PASS
20	DC 21.6V	5736.645921	5725 – 5850	PASS
50	DC 24.0V	5736.590789	5725 – 5850	PASS
40	DC 24.0V	5736.626193	5725 – 5850	PASS
30	DC 24.0V	5736.649580	5725 – 5850	PASS
20	DC 24.0V	5736.670310	5725 – 5850	PASS
10	DC 24.0V	5736.519517	5725 – 5850	PASS
0	DC 24.0V	5736.575579	5725 – 5850	PASS
-10	DC 24.0V	5736.663810	5725 – 5850	PASS
-20	DC 24.0V	5736.691981	5725 – 5850	PASS
-30	DC 24.0V	5736.636927	5725 – 5850	PASS

IEEE 802.11a Mode / 5745 – 5825 MHz / 5825 MHz

Environment Temperature (Degree)	Voltage (V)	Measured Frequency (MHz)	Limit Range (MHz)	Test Results
20	DC 26.4V	5833.632634	5725 – 5850	PASS
20	DC 21.6V	5833.678437	5725 – 5850	PASS
50	DC 24.0V	5833.551042	5725 – 5850	PASS
40	DC 24.0V	5833.571407	5725 – 5850	PASS
30	DC 24.0V	5833.641951	5725 – 5850	PASS
20	DC 24.0V	5833.586704	5725 – 5850	PASS
10	DC 24.0V	5833.631953	5725 – 5850	PASS
0	DC 24.0V	5833.683487	5725 – 5850	PASS
-10	DC 24.0V	5833.594873	5725 – 5850	PASS
-20	DC 24.0V	5833.599700	5725 – 5850	PASS
-30	DC 24.0V	5833.516761	5725 – 5850	PASS

## 4.10. Antenna Requirement

### Standard Applicable

For intentional device, according to FCC 47 CFR Section 15.203, an intentional radiator shall be designed to ensure that no antenna other than that furnished by the responsible party shall be used with the device.

And according to FCC 47 CFR Section 15.407 (a), if transmitting antennas of directional gain greater than 6dBi are used, the power shall be reduced by the amount in dB that the directional gain of the antenna exceeds 6dBi.

### **Antenna Information**

The antenna is Internal Aantenna, through the buckle stretched out, The directional gains of antenna used for transmitting is 2.00dBi.

Reference to the Test Report: **GTS20230704026-1-20.**

**5. TEST SETUP PHOTOS OF THE EUT**

Reference to the test report No. GTS20230704026-1-20.

**6. EXTERNAL AND INTERNAL PHOTOS OF THE EUT**

Reference to the test report No. GTS20230704026-1-20.

.....**End of Report**.....