



Shenzhen Global Test Service Co.,Ltd.

No.7-101 and 8A-104, Building 7 and 8, DCC Cultural and Creative Garden, No.98, Pingxin North Road, Shangmugu Community, Pinghu Street, Longgang District, Shenzhen, Guangdong

FCC PART 15 SUBPART C TEST REPORT

FCC PART 15.247

Report Reference No.:	GTS20230704026-1-22
FCC ID:	2AYD5-I23D01
Compiled by (position+printed name+signature)..:	File administrators Peter Xiao 
Supervised by (position+printed name+signature)..:	Test Engineer Jenny Zeng 
Approved by (position+printed name+signature)..:	Manager Jason Hu 
Date of issue.....:	Aug.18, 2023
Representative Laboratory Name .:	Shenzhen Global Test Service Co.,Ltd.
Address	No.7-101 and 8A-104, Building 7 and 8, DCC Cultural and Creative Garden, No.98, Pingxin North Road, Shangmugu Community, Pinghu Street, Longgang District, Shenzhen, Guangdong,China
Applicant's name	Imin Technology Pte Ltd
Address	11 Bishan Street 21, #03-05 Bosch Building, Singapore 573943
Test specification	
Standard	FCC Part 15.247: Operation within the bands 902-928 MHz, 2400-2483.5 MHz and 5725-5850 MHz
TRF Originator	Shenzhen Global Test Service Co.,Ltd.
Master TRF	Dated 2014-12
Shenzhen Global Test Service Co.,Ltd. All rights reserved.	
This publication may be reproduced in whole or in part for non-commercial purposes as long as the Shenzhen Global Test Service Co.,Ltd. is acknowledged as copyright owner and source of the material. Shenzhen Global Test Service Co.,Ltd. takes no responsibility for and will not assume liability for damages resulting from the reader's interpretation of the reproduced material due to its placement and context.	
Test item description	POS Device
Trade Mark	
Manufacturer	Imin Technology Pte Ltd
Model/Type reference.....	I23D01
Listed Models	N/A
Operation Frequency.....	From 2412MHz to 2462MHz
Hardware Version	N/A
Software Version	N/A
Rating	DC 24V/2.5A by adapter
Result.....	PASS

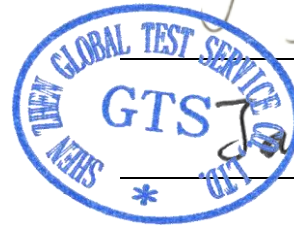

TEST REPORT

Test Report No. : GTS20230704026-1-22	Aug.18, 2023
	Date of issue

Equipment under Test : POS Device

Model /Type : I23D01

Listed model : N/A

Applicant : **Imin Technology Pte Ltd**

Address : 11 Bishan Street 21, #03-05 Bosch Building, Singapore 573943

Manufacturer : **Imin Technology Pte Ltd**

Address : 11 Bishan Street 21, #03-05 Bosch Building, Singapore 573943

Test Result:	PASS
---------------------	-------------

The test report merely corresponds to the test sample.
It is not permitted to copy extracts of these test result without the written permission of the test laboratory.

Contents

1. TEST STANDARDS	4
2. SUMMARY	5
2.1. General Remarks	5
2.2. Product Description	5
2.3. Equipment Under Test	7
2.4. Short description of the Equipment under Test (EUT)	7
2.5. EUT operation mode	7
2.6. Block Diagram of Test Setup	7
2.7. Related Submittal(s) / Grant (s)	8
2.8. EUT Exercise Software	8
2.9. Special Accessories	8
2.10. External I/O Cable	8
2.11. Modifications	8
3. TEST ENVIRONMENT	9
3.1. Address of the test laboratory	9
3.2. Test Facility	9
3.3. Environmental conditions	9
3.4. Statement of the measurement uncertainty	9
3.5. Test Description	10
3.6. Equipments Used during the Test.....	11
4. TEST CONDITIONS AND RESULTS	12
4.1. AC Power Conducted Emission	12
4.2. Radiated Emission	25
4.3. Maximum Peak Output Power	42
4.4. Power Spectral Density	43
4.5. 99% and 6dB Bandwidth	44
4.6. Conducted Spurious Emissions and Band Edge Compliance of RF Emission.....	45
4.7. Antenna Requirement	49
5. TEST SETUP PHOTOS OF THE EUT	50
6. EXTERNAL AND INTERNAL PHOTOS OF THE EUT	50

1. TEST STANDARDS

The tests were performed according to following standards:

[FCC Rules Part 15.247](#): Frequency Hopping, Direct Spread Spectrum and Hybrid Systems that are in operation within the bands of 902-928 MHz, 2400-2483.5 MHz, and 5725-5850 MHz.

[ANSI C63.10-2020](#): American National Standard for Testing Unlicensed Wireless Devices

[KDB 558074 D01 DTS Meas Guidance v05r02](#): Guidance for Performing Compliance Measurements on Digital Transmission Systems (DTS) Operating Under §15.247.

[KDB 662911 D01 Multiple Transmitter Output v02r01](#): Measurement of Transmitters with Multiple Output, MIMO, Smart Antenna.

2. SUMMARY

2.1. General Remarks

Date of receipt of test sample	:	Jul.21, 2023
Testing commenced on	:	Jul.21, 2023
Testing concluded on	:	Aug.17, 2023

2.2. Product Description

Product Name:	POS Device
Trade Mark:	
Model/Type reference:	I23D01
List Model:	N/A
Model Declaration	N/A
Power supply:	DC 24V/2.5A by adapter
Hardware Version	N/A
Software Version	N/A
Sample ID	GTS20230704026-1-S0001-1#& GTS20230704026-1-S0001-2#
Bluetooth	
Frequency Range	2402MHz ~ 2480MHz
Channel Number	79 channels for Bluetooth (DSS) 40 channels for Bluetooth (DTS)
Channel Spacing	1MHz for Bluetooth (DSS) 2MHz for Bluetooth (DTS)
Modulation Type	GFSK, $\pi/4$ -DQPSK, 8DPSK for Bluetooth (DSS) GFSK for Bluetooth (DTS)
2.4GWLAN	
WLAN Operation frequency	IEEE 802.11b:2412-2462MHz IEEE 802.11g:2412-2462MHz IEEE 802.11n HT20:2412-2462MHz IEEE 802.11ax HE20:2412-2462MHz
WLAN Modulation Type	IEEE 802.11b: DSSS(CCK,DQPSK,DBPSK) IEEE 802.11g: OFDM(64QAM, 16QAM, QPSK, BPSK) IEEE 802.11n HT20: OFDM (64QAM, 16QAM, QPSK,BPSK) IEEE 802.11ax HE20: OFDMA(1024QAM,256QAM,64QAM,16QAM, QPSK,BPSK)
Channel number:	11 Channel for IEEE 802.11b/g/n/ax (HT20)
Channel separation:	5MHz
WIFI(5.2G/5.3G/5.7G/5.8G Band)	
WLAN Operation frequency	5180-5240MHz/ 5260MHz to 5320MHz/ 5500MHz to 5700MHz/ 5745MHz to 5825MHz
WLAN Modulation Type	IEEE 802.11a: OFDM(64QAM, 16QAM, QPSK, BPSK) IEEE 802.11n HT20: OFDM (64QAM, 16QAM, QPSK,BPSK) IEEE 802.11ac VHT20: OFDM (256QAM,64QAM, 16QAM, QPSK,BPSK) IEEE 802.11ax HE20: OFDMA (1024QAM,256QAM,64QAM, 16QAM, QPSK,BPSK) IEEE 802.11n HT40: OFDM (64QAM, 16QAM, QPSK,BPSK) IEEE 802.11ac VHT40: OFDM (256QAM,64QAM, 16QAM, QPSK,BPSK)

	IEEE 802.11ax HE40: OFDMA (1024QAM,256QAM,64QAM, 16QAM, QPSK,BPSK) IEEE 802.11ac VHT80: OFDM (256QAM,64QAM, 16QAM, QPSK,BPSK) IEEE 802.11ax HE80: OFDMA (1024QAM,256QAM,64QAM, 16QAM, QPSK,BPSK)
Channel number:	4 Channels for 20MHz bandwidth(5180-5240MHz) 4 Channels for 20MHz bandwidth(5260-5320MHz) 11 Channels for 20MHz bandwidth(5500-5700MHz) 5 channels for 20MHz bandwidth(5745-5825MHz) 2 channels for 40MHz bandwidth(5190~5230MHz) 2 channels for 40MHz bandwidth(5270~5310MHz) 5 Channels for 40MHz bandwidth(5510-5670MHz) 2 channels for 40MHz bandwidth(5755~5795MHz) 1 channels for 80MHz bandwidth(5210MHz) 1 channels for 80MHz bandwidth(5290MHz) 2 Channels for 80MHz bandwidth(5530-5610MHz) 1 channels for 80MHz bandwidth(5775MHz)
Antenna Description	Three Internal antenna respectively.WLAN support 2*2MIMO technology. ANT0 used for WIFI TX/RX, 2.00 dBi(Max.) for 2.4G Band and 2.00dBi(Max.) for 5G Band ANT1 used for WIFI TX/RX, 2.00 dBi(Max.) for 2.4G Band and 2.00dBi (Max.) for 5G Band ANT2 used for BT TX/RX, 2.00 dBi(Max.) for 2.4G Band
Remark:The I23D01 model has 3 versions; Version A: Two identical large screens Version B: One large display and one small display Version C: Only one large display	

2.3. Equipment Under Test

Power supply system utilised

Power supply voltage	:	<input type="radio"/> 230V / 50 Hz	<input type="radio"/> 120V / 60Hz
		<input type="radio"/> 12 V DC	<input checked="" type="radio"/> 24 V DC
		<input type="radio"/> Other (specified in blank below)	

DC 24.0V

2.4. Short description of the Equipment under Test (EUT)

For more details, refer to the user’s manual of the EUT.

2.5. EUT operation mode

The application provider specific test software to control sample in continuous TX and RX (Duty Cycle >98%) for testing meet KDB558074 test requirement.

IEEE 802.11b/g/n/ax: Thirteen channels are provided to the EUT.

Antenna	Chain 0		Chain 1		Simultaneously
	20MHz	40MHz	20MHz	40MHz	
IEEE 802.11b	<input checked="" type="checkbox"/>	<input type="checkbox"/>	<input checked="" type="checkbox"/>	<input type="checkbox"/>	<input type="checkbox"/>
IEEE 802.11g	<input checked="" type="checkbox"/>	<input type="checkbox"/>	<input checked="" type="checkbox"/>	<input type="checkbox"/>	<input type="checkbox"/>
IEEE 802.11n	<input checked="" type="checkbox"/>	<input type="checkbox"/>	<input checked="" type="checkbox"/>	<input type="checkbox"/>	<input checked="" type="checkbox"/>
IEEE 802.11ax	<input checked="" type="checkbox"/>	<input type="checkbox"/>	<input checked="" type="checkbox"/>	<input type="checkbox"/>	<input checked="" type="checkbox"/>

Channel	Frequency(MHz)	Channel	Frequency(MHz)
1	2412	8	2447
2	2417	9	2452
3	2422	10	2457
4	2427	11	2462
5	2432		
6	2437		
7	2442		

The EUT has been tested under operating condition.

AC main conducted emission pre-test voltage at both AC 120V/60Hz and AC 240V/60Hz, recorded worst case;
 AC main conducted emission pre-test at charge from PC modes, recorded worst case;

This test was performed with EUT in X, Y, Z position and the worst case was found when EUT in X position.

Worst-case mode and channel used for 9 KHz-1000 MHz radiated emissions was the mode and channel with the highest output power, that was determined to be IEEE 802.11g mode (MCH).

AX mode tested all RU, only worst case mode (Full RU) recorded in report.

2.6. Block Diagram of Test Setup

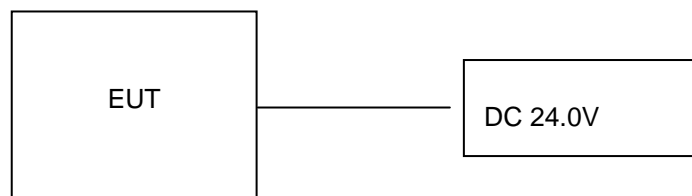

2.7. Related Submittal(s) / Grant (s)

This submittal(s) (test report) is intended for **FCC ID: 2AYD5-I23D01** filing to comply with Section 15.247 of the FCC Part 15, Subpart C Rules.

2.8. EUT Exercise Software

The system was configured for testing in a continuous transmits condition and change test channels by software (adb model) provided by application.

2.9. Special Accessories

Manufacturer	Description	Model	Serial Number	Certificate
Jiangsu Chenyang Electron Co.,Ltd.	Adapter	CYSE65-240250	--	SDOC
Shenzhen SOY Technology Co.,Ltd.	Adapter	SOY-2400250-332-A	--	SDOC
JiangSu Sunward Electronic Technology Co., Ltd	Adapter	AD65CM249250A	--	SDOC
SHENZHEN HONOR ELECTRONIC CO.,LTD.	Adapter	ADS-65HI-19A-1 24060E	--	SDOC
LENOVO	PC	DESKYOP-EUIVCNR	--	SDOC
LENOVO	Keyboard	T460S	--	SDOC
LENOVO	Mouse	Howard	--	SDOC
SONY	Earphone	MDR-XB550AP	--	SDOC
aigo	USB flash disk	U330	--	SDOC

Note: The PC, Keyboard, Mouse, Earphone and USB flash disk is only used for auxiliary testing.

2.10. External I/O Cable

I/O Port Description	Quantity	Cable
DC IN Port	1	Non-Shielded, 1.0m
USB Port	3	N/A
LAN Port	1	Non-Shielded, 10m
Type-C Port	1	N/A
TF Cart	1	N/A
RJ11 Port	2	N/A
Earphone	1	N/A

2.11. Modifications

No modifications were implemented to meet testing criteria.

3. TEST ENVIRONMENT

3.1. Address of the test laboratory

Shenzhen Global Test Service Co.,Ltd.

No.7-101 and 8A-104, Building 7 and 8, DCC Cultural and Creative Garden, No.98, Pingxin North Road, Shangmugu Community, Pinghu Street, Longgang District, Shenzhen, Guangdong,China.

3.2. Test Facility

The test facility is recognized, certified, or accredited by the following organizations:

CNAS (No. CNAS L8169)

Shenzhen Global Test Service Co., Ltd. has been assessed and proved to be in compliance with CNAS-CL01 Accreditation Criteria for Testing and Calibration Laboratories (identical to ISO/IEC 17025: 2019 General Requirements) for the Competence of Testing and Calibration Laboratories.

A2LA (Certificate No. 4758.01)

Shenzhen Global Test Service Co., Ltd. has been assessed by the American Association for Laboratory Accreditation (A2LA). Certificate No. 4758.01.

Industry Canada Registration Number. is 24189.

FCC Designation Number is CN1234.

FCC Registered Test Site Number is165725.

3.3. Environmental conditions

During the measurement the environmental conditions were within the listed ranges:

Temperature:	15-35 ° C
Humidity:	30-60 %
Atmospheric pressure:	950-1050mbar

3.4. Statement of the measurement uncertainty

The data and results referenced in this document are true and accurate. The reader is cautioned that there may be errors within the calibration limits of the equipment and facilities. The measurement uncertainty was calculated for all measurements listed in this test report acc. to CISPR 16 - 4 „Specification for radio disturbance and immunity measuring apparatus and methods – Part 4: Uncertainty in EMC Measurements“ and is documented in the Shenzhen Global Test Service Co.,Ltd quality system acc. to DIN EN ISO/IEC 17025. Furthermore, component and process variability of devices similar to that tested may result in additional deviation. The manufacturer has the sole responsibility of continued compliance of the device.

Hereafter the best measurement capability for Shenzhen GTS laboratory is reported:

Test	Range	Measurement Uncertainty	Notes
Radiated Emission	30~1000MHz	4.10 dB	(1)
Radiated Emission	1~18GHz	4.32 dB	(1)
Radiated Emission	18-40GHz	5.54 dB	(1)
Conducted Disturbance	0.15~30MHz	3.12 dB	(1)

This uncertainty represents an expanded uncertainty expressed at approximately the 95% confidence level using a coverage factor of k=2.

3.5. Test Description

Applied Standard: FCC Part 15 Subpart C				
FCC Rules	Description of Test	Test Sample	Result	Remark
/	On Time and Duty Cycle	GTS20230704026-1-S0001-1#	/	/
§15.247(b)	Maximum Conducted Output Power	GTS20230704026-1-S0001-1#	Compliant	Appendix C
§15.247(e)	Power Spectral Density	GTS20230704026-1-S0001-1#	Compliant	Appendix C
§15.247(a)(2)	6dB Bandwidth	GTS20230704026-1-S0001-1#	Compliant	Appendix C
§2.1047	99% Occupied Bandwidth	GTS20230704026-1-S0001-1#	Compliant	Appendix C
§15.209, §15.247(d)	Conducted Spurious Emissions and Band Edges Test	GTS20230704026-1-S0001-1#	Compliant	Appendix C
§15.209, §15.247(d)	Radiated Spurious Emissions	GTS20230704026-1-S0001-1# GTS20230704026-1-S0001-2#	Compliant	Note 1
§15.205	Emissions at Restricted Band	GTS20230704026-1-S0001-1#	Compliant	Note 1
§15.207(a)	AC Conducted Emissions	GTS20230704026-1-S0001-2#	Compliant	Note 1
§15.203 §15.247(c)	Antenna Requirements	GTS20230704026-1-S0001-1#	Compliant	Note 1
§15.247(i)§2.1091	RF Exposure	/	Compliant	Note 2

Remark:

1. The measurement uncertainty is not included in the test result.
2. NA = Not Applicable; NP = Not Performed
3. Note 1 – Test results inside test report;
4. Note 2 – Test results in other test report (MPE Report).
5. We tested all test mode and recorded worst case in report

Preliminary tests were performed in different data rate to find the worst radiated emission. The data rate shown in the table below is the worst-case rate with respect to the specific test item. Investigation has been done on all the possible configurations for searching the worst cases. The following table is a list of the test modes shown in this test report.

Test Items	Mode	Data Rate	Channel
Maximum Peak Conducted Output Power Power Spectral Density 6dB Bandwidth Spurious RF conducted emission Radiated Emission 9kHz~1GHz& Radiated Emission 1GHz~10 th Harmonic	11b/DSSS	1 Mbps	1/6/11
	11g/OFDM	6 Mbps	1/6/11
	11n(20MHz)/OFDM	6.5Mbps	1/6/11
	11ax(20MHz)/OFDMA	8.6Mbps	1/6/11
Band Edge	11b/DSSS	1 Mbps	1/11
	11g/OFDM	6 Mbps	1/11
	11n(20MHz)/OFDM	6.5Mbps	1/11
	11ax(20MHz)/OFDMA	8.6Mbps	1/11

3.6. Equipments Used during the Test

Test Equipment	Manufacturer	Model No.	Serial No.	Calibration Date	Calibration Due Date
LISN	CYBERTEK	EM5040A	E1850400105	2023/07/13	2024/07/12
LISN	R&S	ESH2-Z5	893606/008	2023/07/13	2024/07/12
EMI Test Receiver	R&S	ESPI3	101841-cd	2023/07/13	2024/07/12
EMI Test Receiver	R&S	ESCI7	101102	2022/09/09	2023/09/08
Spectrum Analyzer	Agilent	N9020A	MY48010425	2022/09/09	2023/09/08
Spectrum Analyzer	R&S	FSV40	100019	2023/07/13	2024/07/12
Vector Signal generator	Agilent	N5181A	MY49060502	2023/07/13	2024/07/12
Signal generator	Agilent	N5182A	3610AO1069	2022/09/09	2023/09/08
Climate Chamber	ESPEC	EL-10KA	A20120523	2022/09/09	2023/09/08
Controller	EM Electronics	Controller EM 1000	N/A	N/A	N/A
Horn Antenna	Schwarzbeck	BBHA 9120D	01622	2022/09/09	2023/09/08
Active Loop Antenna	Beijing Da Ze Technology Co.,Ltd.	ZN30900C	15006	2022/09/09	2023/09/08
Bilog Antenna	Schwarzbeck	VULB9163	000976	2023/07/13	2024/07/12
Broadband Horn Antenna	SCHWARZBECK	BBHA 9170	791	2022/09/09	2023/09/08
Amplifier	Schwarzbeck	BBV 9743	#202	2023/07/13	2024/07/12
Amplifier	Schwarzbeck	BBV9179	9719-025	2023/07/13	2024/07/12
Amplifier	EMCI	EMC051845B	980355	2023/07/13	2024/07/12
Temperature/Humidity Meter	Gangxing	CTH-608	02	2023/07/13	2024/07/12
High-Pass Filter	K&L	9SH10-2700/X12750-O/O	KL142031	2023/07/13	2024/07/12
High-Pass Filter	K&L	41H10-1375/U12750-O/O	KL142032	2023/07/13	2024/07/12
RF Cable(below 1GHz)	HUBER+SUHNER	RG214	RE01	2023/07/13	2024/07/12
RF Cable(above 1GHz)	HUBER+SUHNER	RG214	RE02	2023/07/13	2024/07/12
Data acquisition card	Agilent	U2531A	TW53323507	2023/07/13	2024/07/12
Power Sensor	Agilent	U2021XA	MY5365004	2023/07/13	2024/07/12
Test Control Unit	Tonscend	JS0806-1	178060067	2023/07/13	2024/07/12
Automated filter bank	Tonscend	JS0806-F	19F8060177	2023/07/13	2024/07/12
EMI Test Software	Tonscend	JS1120-1	Ver 2.6.8.0518	/	/
EMI Test Software	Tonscend	JS1120-3	Ver 2.5.77.0418	/	/
EMI Test Software	Tonscend	JS32-CE	Ver 2.5	/	/
EMI Test Software	Tonscend	JS32-RE	Ver 2.5.1.8	/	/

Note: The Cal.Interval was one year.

4. TEST CONDITIONS AND RESULTS

4.1. AC Power Conducted Emission

TEST CONFIGURATION

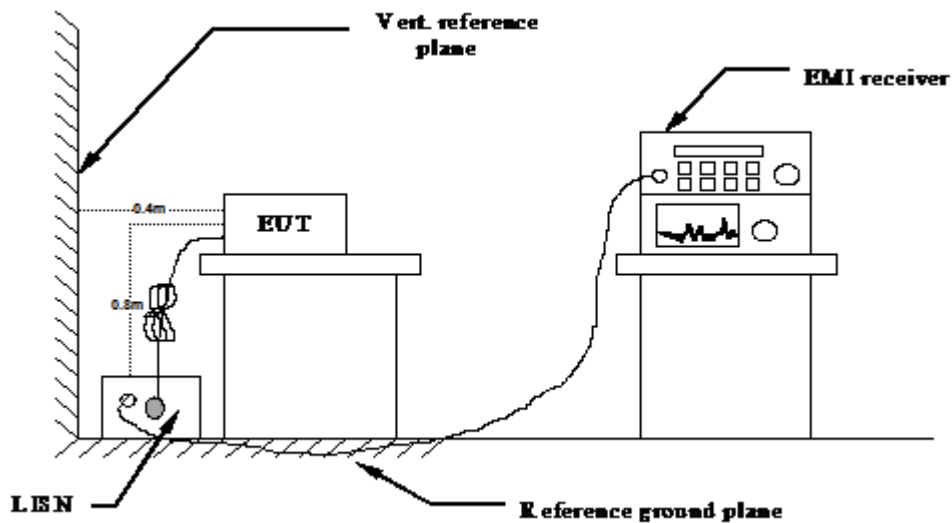

TEST PROCEDURE

- 1 The equipment was set up as per the test configuration to simulate typical actual usage per the user's manual. The EUT is a tabletop system, a wooden table with a height of 0.8 meters is used and is placed on the ground plane as per ANSI C63.10-2020.
- 2 Support equipment, if needed, was placed as per ANSI C63.10-2020.
- 3 All I/O cables were positioned to simulate typical actual usage as per ANSI C63.10-2020.
- 4 The EUT received DC 24V power, the adapter received AC120V/60Hz or AC 240V/60Hz power through a Line Impedance Stabilization Network (LISN) which supplied power source and was grounded to the ground plane.
- 5 All support equipments received AC power from a second LISN, if any.
- 6 The EUT test program was started. Emissions were measured on each current carrying line of the EUT using a spectrum Analyzer / Receiver connected to the LISN powering the EUT. The LISN has two monitoring points: Line 1 (Hot Side) and Line 2 (Neutral Side). Two scans were taken: one with Line 1 connected to Analyzer / Receiver and Line 2 connected to a 50 ohm load; the second scan had Line 1 connected to a 50 ohm load and Line 2 connected to the Analyzer / Receiver.
- 7 Analyzer / Receiver scanned from 150 KHz to 30MHz for emissions in each of the test modes.
- 8 During the above scans, the emissions were maximized by cable manipulation.

AC Power Conducted Emission Limit

For intentional device, according to § 15.207(a) AC Power Conducted Emission Limits is as following :

Frequency range (MHz)	Limit (dBuV)	
	Quasi-peak	Average
0.15-0.5	66 to 56*	56 to 46*
0.5-5	56	46
5-30	60	50

* Decreases with the logarithm of the frequency.

TEST RESULTS

Remark: We measured Conducted Emission at 802.11b/802.11g/802.11n HT20 /802.11ax HE20 mode from 150 KHz to 30MHz in AC120V and the worst case was recorded.

Temperature	25°C	Humidity	60%
Test Engineer	Jenny Zeng	Configurations	IEEE 802.11g (MCH)

Version A:
Adapter: CYSE65-240250

Power supply:	AC 120V/60Hz	Polarization	L
---------------	--------------	--------------	---

Test Graph

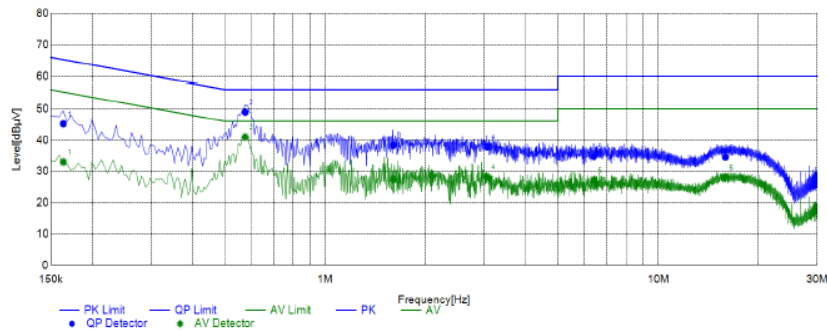

Final Data List

NO.	Frequency	QP	AVG.	Factor	QP	AVG.	QP	AVG.	QP	AVG.	Line	Remark
		Reading	Reading		Result	Result	Limit	Limit	Margin	Margin		
1	0.1636	35.59	23.40	9.60	45.19	33.00	65.28	55.28	20.09	22.28	L1	PASS
2	0.5752	39.24	31.42	9.63	48.87	41.05	56.00	46.00	7.13	4.95	L1	PASS
3	1.5999	29.00	18.09	9.38	38.38	27.47	56.00	46.00	17.62	18.53	L1	PASS
4	3.0658	28.45	18.90	9.35	37.80	28.25	56.00	46.00	18.20	17.75	L1	PASS
5	6.4117	25.40	17.88	9.33	34.73	27.21	60.00	50.00	25.27	22.79	L1	PASS
6	15.9129	25.36	18.96	9.18	34.54	28.14	60.00	50.00	25.46	21.86	L1	PASS

Note: 1. Result (dBµ A) = Reading (dBµ A) + Factor (dB).

2. Factor (dB) = Cable loss (dB) + LISN Factor (dB).

Power supply:	AC 120V/60Hz	Polarization	N
---------------	--------------	--------------	---

Test Graph

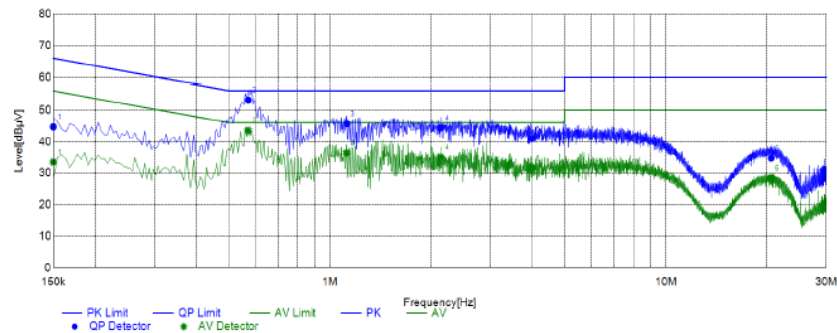

Final Data List

NO.	Frequency	QP	AVG.	Factor	QP	AVG.	QP	AVG.	QP	AVG.	Line	Remark
		Reading	Reading		Result	Result	Limit	Limit	Margin	Margin		
1	0.1500	35.07	23.87	9.61	44.68	33.48	66.00	56.00	21.32	22.52	N	PASS
2	0.5712	43.74	34.13	9.40	53.14	43.53	56.00	46.00	2.86	2.47	N	PASS
3	1.1206	36.31	27.04	9.37	45.68	36.41	56.00	46.00	10.32	9.59	N	PASS
4	2.1382	35.01	25.78	9.35	44.36	35.13	56.00	46.00	11.64	10.87	N	PASS
5	3.9868	31.55	22.21	9.40	40.95	31.61	56.00	46.00	15.05	14.39	N	PASS
6	20.5675	25.54	19.22	9.24	34.78	28.46	60.00	50.00	25.22	21.54	N	PASS

Note: 1. Result (dBµ A) = Reading (dBµ A) + Factor (dB).

2. Factor (dB) = Cable loss (dB) + LISN Factor (dB).

Adapter: SOY-2400250-332-A

Power supply:	AC 120V/60Hz	Polarization	L
---------------	--------------	--------------	---

Test Graph

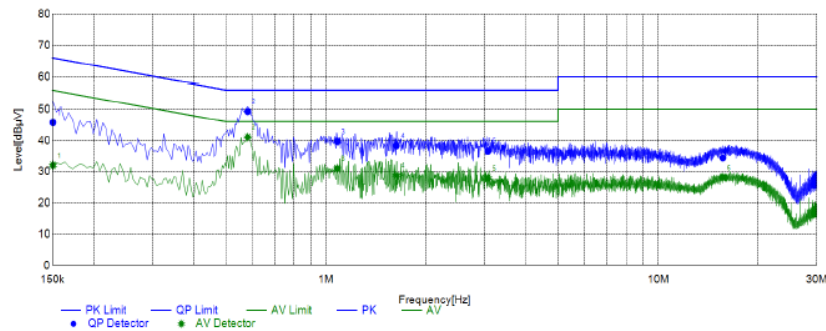

Final Data List												
NO.	Frequency	QP	AVG.	Factor	QP	AVG.	QP	AVG.	QP	AVG.	Line	Remark
		Reading	Reading		Result	Result	Limit	Limit	Margin	Margin		
1	0.1507	36.15	22.47	9.60	45.75	32.07	65.96	55.96	20.21	23.89	L1	PASS
2	0.5805	39.62	31.42	9.64	49.26	41.06	56.00	46.00	6.74	4.94	L1	PASS
3	1.0800	30.30	21.66	9.39	39.69	31.05	56.00	46.00	16.31	14.95	L1	PASS
4	1.6298	28.97	19.44	9.37	38.34	28.81	56.00	46.00	17.66	17.19	L1	PASS
5	3.0718	27.28	18.56	9.35	36.63	27.91	56.00	46.00	19.37	18.09	L1	PASS
6	15.6482	25.23	19.01	9.17	34.40	28.18	60.00	50.00	25.60	21.82	L1	PASS

Note: 1. Result (dBµ A) = Reading (dBµ A) + Factor (dB).

2. Factor (dB) = Cable loss (dB) + LISN Factor (dB).

Power supply:	AC 120V/60Hz	Polarization	N
---------------	--------------	--------------	---

Test Graph

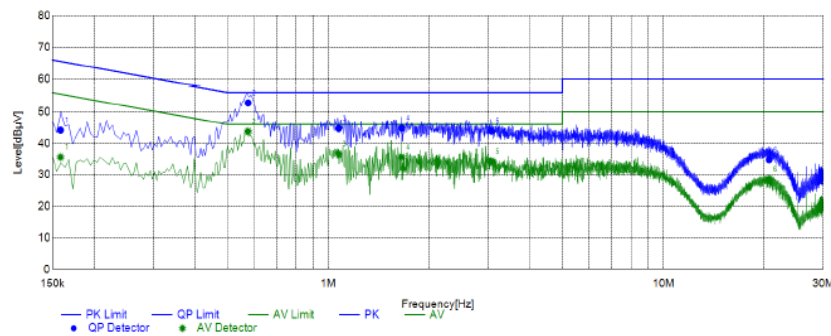

Final Data List												
NO.	Frequency	QP	AVG.	Factor	QP	AVG.	QP	AVG.	QP	AVG.	Line	Remark
		Reading	Reading		Result	Result	Limit	Limit	Margin	Margin		
1	0.1587	34.57	26.00	9.60	44.17	35.60	65.53	55.53	21.36	19.93	N	PASS
2	0.5756	43.39	34.35	9.40	52.79	43.75	56.00	46.00	3.21	2.25	N	PASS
3	1.0721	35.36	27.27	9.37	44.73	36.64	56.00	46.00	11.27	9.36	N	PASS
4	1.6559	35.47	26.27	9.36	44.83	35.63	56.00	46.00	11.17	10.37	N	PASS
5	3.0666	34.56	25.04	9.33	43.89	34.37	56.00	46.00	12.11	11.63	N	PASS
6	20.6807	25.55	19.40	9.22	34.77	28.62	60.00	50.00	25.23	21.38	N	PASS

Note: 1. Result (dBµ A) = Reading (dBµ A) + Factor (dB).

2. Factor (dB) = Cable loss (dB) + LISN Factor (dB).

Adapter: AD65CM249250A

Power supply:	AC 120V/60Hz	Polarization	L
---------------	--------------	--------------	---

Test Graph

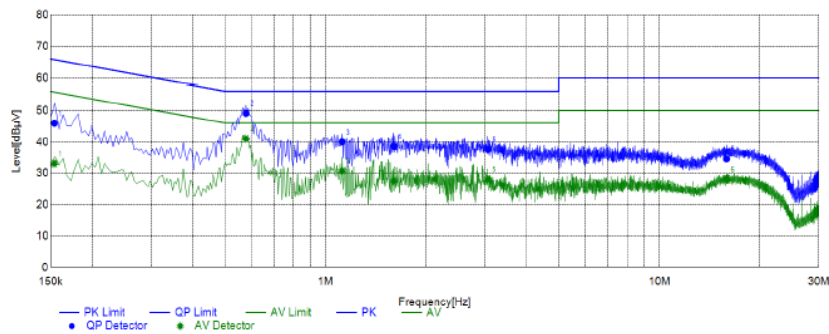

Final Data List												
NO.	Frequency	QP	AVG.	Factor	QP	AVG.	QP	AVG.	QP	AVG.	Line	Remark
		Reading	Reading		Result	Result	Limit	Limit	Margin	Margin		
1	0.1539	36.34	23.50	9.60	45.94	33.10	65.79	55.79	19.85	22.69	L1	PASS
2	0.5769	39.47	31.40	9.63	49.10	41.03	56.00	46.00	6.90	4.97	L1	PASS
3	1.1200	30.58	21.37	9.39	39.97	30.76	56.00	46.00	16.03	15.24	L1	PASS
4	1.5997	29.19	18.12	9.38	38.57	27.50	56.00	46.00	17.43	18.50	L1	PASS
5	3.0657	28.28	18.83	9.35	37.63	28.18	56.00	46.00	18.37	17.82	L1	PASS
6	15.8927	25.42	19.02	9.18	34.60	28.20	60.00	50.00	25.40	21.80	L1	PASS

Note: 1. Result (dBµ A) = Reading (dBµ A) + Factor (dB).

2. Factor (dB) = Cable loss (dB) + LISN Factor (dB).

Power supply:	AC 120V/60Hz	Polarization	N
---------------	--------------	--------------	---

Test Graph

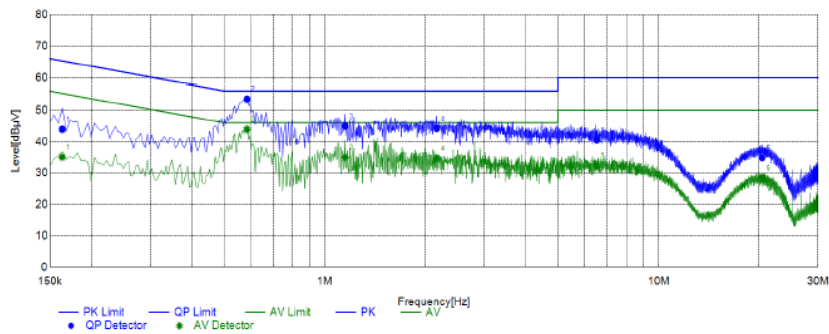

Final Data List												
NO.	Frequency	QP	AVG.	Factor	QP	AVG.	QP	AVG.	QP	AVG.	Line	Remark
		Reading	Reading		Result	Result	Limit	Limit	Margin	Margin		
1	0.1633	34.36	25.46	9.60	43.96	35.06	65.29	55.29	21.33	20.23	N	PASS
2	0.5839	44.12	34.52	9.40	53.52	43.92	56.00	46.00	2.48	2.08	N	PASS
3	1.1510	35.57	25.65	9.38	44.95	35.03	56.00	46.00	11.05	10.97	N	PASS
4	2.1635	34.86	25.40	9.33	44.19	34.73	56.00	46.00	11.81	11.27	N	PASS
5	6.5234	31.15	23.16	9.32	40.47	32.48	60.00	50.00	19.53	17.52	N	PASS
6	20.4105	25.60	19.34	9.23	34.83	28.57	60.00	50.00	25.17	21.43	N	PASS

Note: 1. Result (dBµ A) = Reading (dBµ A) + Factor (dB).

2. Factor (dB) = Cable loss (dB) + LISN Factor (dB).

Adapter: ADS-65HI-19A-1 24060E

Power supply:	AC 120V/60Hz	Polarization	L
---------------	--------------	--------------	---

Test Graph

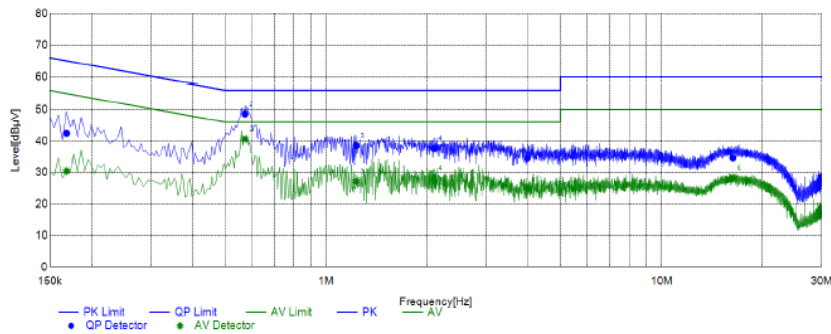

Final Data List												
NO.	Frequency	QP	AVG.	Factor	QP	AVG.	QP	AVG.	QP	AVG.	Line	Remark
		Reading	Reading		Result	Result	Limit	Limit	Margin	Margin		
1	0.1682	32.89	20.87	9.60	42.49	30.47	65.05	55.05	22.56	24.58	L1	PASS
2	0.5726	38.98	31.02	9.62	48.60	40.64	56.00	46.00	7.40	5.36	L1	PASS
3	1.2276	29.16	17.79	9.40	38.56	27.19	56.00	46.00	17.44	18.81	L1	PASS
4	2.0995	28.32	19.01	9.36	37.68	28.37	56.00	46.00	18.32	17.63	L1	PASS
5	3.9813	25.18	15.61	9.42	34.60	25.03	56.00	46.00	21.40	20.97	L1	PASS
6	16.3167	25.43	19.09	9.17	34.60	28.26	60.00	50.00	25.40	21.74	L1	PASS

Note: 1. Result (dBµ A) = Reading (dBµ A) + Factor (dB).

2. Factor (dB) = Cable loss (dB) + LISN Factor (dB).

Power supply:	AC 120V/60Hz	Polarization	N
---------------	--------------	--------------	---

Test Graph

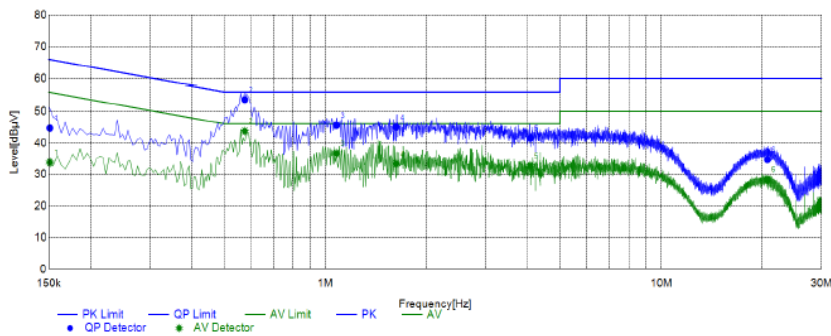

Final Data List												
NO.	Frequency	QP	AVG.	Factor	QP	AVG.	QP	AVG.	QP	AVG.	Line	Remark
		Reading	Reading		Result	Result	Limit	Limit	Margin	Margin		
1	0.1512	35.06	24.19	9.61	44.67	33.80	65.94	55.94	21.27	22.14	N	PASS
2	0.5750	44.25	34.31	9.40	53.65	43.71	56.00	46.00	2.35	2.29	N	PASS
3	1.0782	36.15	27.34	9.37	45.52	36.71	56.00	46.00	10.48	9.29	N	PASS
4	1.6255	35.64	24.00	9.36	45.00	33.36	56.00	46.00	11.00	12.64	N	PASS
5	4.0733	32.01	23.40	9.39	41.40	32.79	56.00	46.00	14.60	13.21	N	PASS
6	20.7157	25.49	19.24	9.22	34.71	28.46	60.00	50.00	25.29	21.54	N	PASS

Note: 1. Result (dBµ A) = Reading (dBµ A) + Factor (dB).

2. Factor (dB) = Cable loss (dB) + LISN Factor (dB).

Version B:
Adapter: CYSE65-240250

Power supply:	AC 120V/60Hz	Polarization	L
---------------	--------------	--------------	---

Test Graph

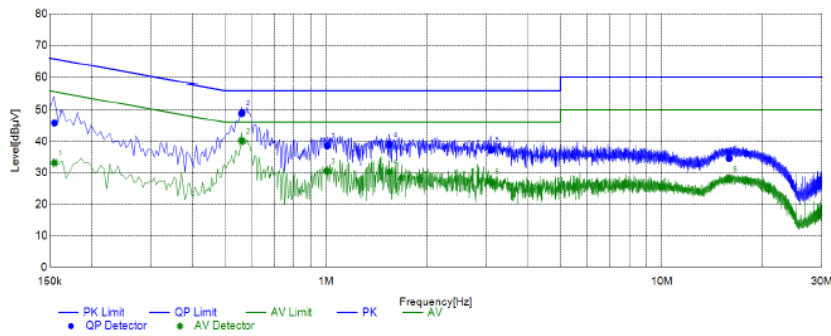

Final Data List												
NO.	Frequency	QP Reading	AVG. Reading	Factor	QP Result	AVG. Result	QP Limit	AVG. Limit	QP Margin	AVG. Margin	Line	Remark
1	0.1549	36.20	23.54	9.60	45.80	33.14	65.74	55.74	19.94	22.60	L1	PASS
2	0.5606	39.29	30.59	9.58	48.87	40.17	56.00	46.00	7.13	5.83	L1	PASS
3	1.0073	29.18	21.13	9.38	38.56	30.51	56.00	46.00	17.44	15.49	L1	PASS
4	1.5419	29.55	20.93	9.37	38.92	30.30	56.00	46.00	17.08	15.70	L1	PASS
5	3.1015	27.94	17.76	9.35	37.29	27.11	56.00	46.00	18.71	18.89	L1	PASS
6	15.8810	25.39	19.04	9.18	34.57	28.22	60.00	50.00	25.43	21.78	L1	PASS

Note: 1. Result (dBµ A) = Reading (dBµ A) + Factor (dB).

2. F factor (dB) = Cable loss (dB) + LISN Factor (dB).

Power supply:	AC 120V/60Hz	Polarization	N
---------------	--------------	--------------	---

Test Graph

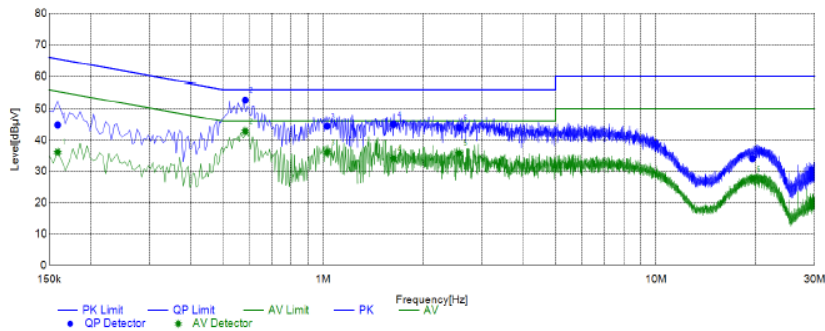

Final Data List												
NO.	Frequency	QP Reading	AVG. Reading	Factor	QP Result	AVG. Result	QP Limit	AVG. Limit	QP Margin	AVG. Margin	Line	Remark
1	0.1592	35.20	26.59	9.60	44.80	36.19	65.51	55.51	20.71	19.32	N	PASS
2	0.5826	43.33	33.47	9.40	52.73	42.87	56.00	46.00	3.27	3.13	N	PASS
3	1.0271	35.11	26.72	9.36	44.47	36.08	56.00	46.00	11.53	9.92	N	PASS
4	1.6277	35.68	24.75	9.36	45.04	34.11	56.00	46.00	10.96	11.89	N	PASS
5	2.5635	34.62	26.46	9.34	43.96	35.80	56.00	46.00	12.04	10.20	N	PASS
6	19.5104	24.78	18.57	9.22	34.00	27.79	60.00	50.00	26.00	22.21	N	PASS

Note: 1. Result (dBµ A) = Reading (dBµ A) + Factor (dB).

2. F factor (dB) = Cable loss (dB) + LISN Factor (dB).

Adapter: SOY-2400250-332-A

Power supply:	AC 120V/60Hz	Polarization	L
---------------	--------------	--------------	---

Test Graph

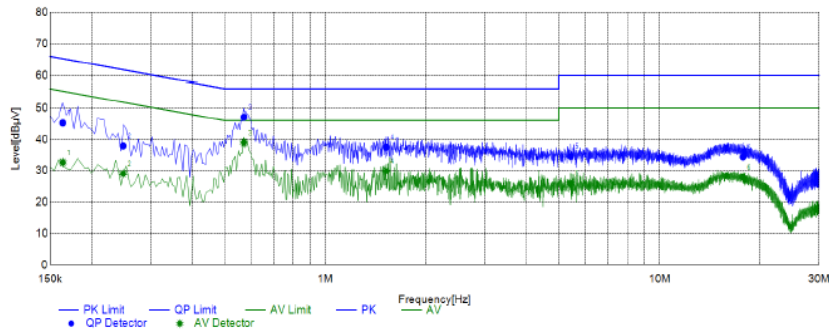

Final Data List

NO.	Frequency	QP	AVG.	Factor	QP	AVG.	QP	AVG.	QP	AVG.	Line	Remark
		Reading	Reading		Result	Result	Limit	Limit	Margin	Margin		
1	0.1638	35.63	23.05	9.60	45.23	32.65	65.27	55.27	20.04	22.62	L1	PASS
2	0.2482	28.44	19.62	9.49	37.93	29.11	61.82	51.82	23.89	22.71	L1	PASS
3	0.5707	37.45	29.34	9.61	47.06	38.95	56.00	46.00	8.94	7.05	L1	PASS
4	1.5191	28.13	20.54	9.38	37.51	29.92	56.00	46.00	18.49	16.08	L1	PASS
5	5.4162	25.23	16.73	9.36	34.59	26.09	60.00	50.00	25.41	23.91	L1	PASS
6	17.7736	25.17	18.76	9.19	34.36	27.95	60.00	50.00	25.64	22.05	L1	PASS

Note: 1. Result (dBµ A) = Reading (dBµ A) + Factor (dB).

2. Factor (dB) = Cable loss (dB) + LISN Factor (dB).

Power supply:	AC 120V/60Hz	Polarization	N
---------------	--------------	--------------	---

Test Graph

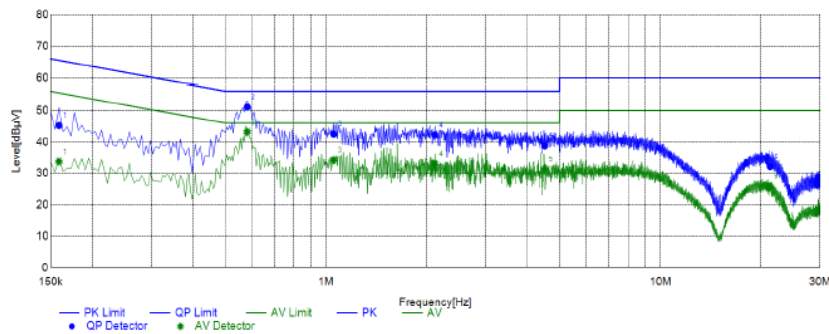

Final Data List

NO.	Frequency	QP	AVG.	Factor	QP	AVG.	QP	AVG.	QP	AVG.	Line	Remark
		Reading	Reading		Result	Result	Limit	Limit	Margin	Margin		
1	0.1589	35.62	24.12	9.60	45.22	33.72	65.52	55.52	20.30	21.80	N	PASS
2	0.5804	41.71	33.85	9.40	51.11	43.25	56.00	46.00	4.89	2.75	N	PASS
3	1.0545	33.17	24.92	9.37	42.54	34.29	56.00	46.00	13.46	11.71	N	PASS
4	2.1162	32.89	23.77	9.35	42.24	33.12	56.00	46.00	13.76	12.88	N	PASS
5	4.5123	29.38	22.06	9.37	38.75	31.43	56.00	46.00	17.25	14.57	N	PASS
6	21.2791	22.97	16.67	9.24	32.21	25.91	60.00	50.00	27.79	24.09	N	PASS

Note: 1. Result (dBµ A) = Reading (dBµ A) + Factor (dB).

2. Factor (dB) = Cable loss (dB) + LISN Factor (dB).

Adapter: AD65CM249250A

Power supply:	AC 120V/60Hz	Polarization	L
---------------	--------------	--------------	---

Test Graph

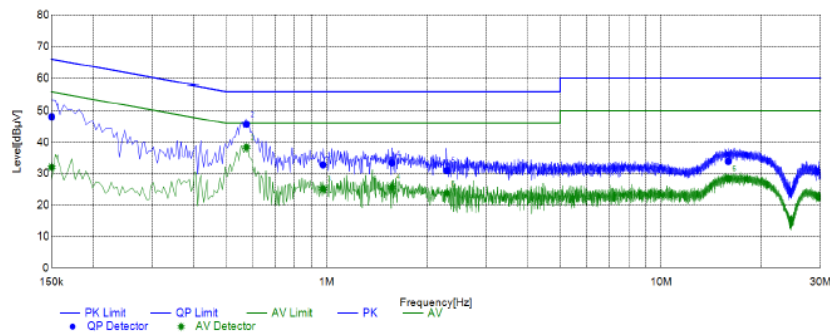

Final Data List												
NO.	Frequency	QP	AVG.	Factor	QP	AVG.	QP	AVG.	QP	AVG.	Line	Remark
		Reading	Reading		Result	Result	Limit	Limit	Margin	Margin		
1	0.1504	38.50	22.46	9.60	48.10	32.06	65.98	55.98	17.88	23.92	L1	PASS
2	0.5753	36.05	28.78	9.63	45.68	38.41	56.00	46.00	10.32	7.59	L1	PASS
3	0.9744	23.38	15.89	9.38	32.76	25.27	56.00	46.00	23.24	20.73	L1	PASS
4	1.5679	24.01	16.35	9.38	33.39	25.73	56.00	46.00	22.61	20.27	L1	PASS
5	2.2911	21.72	14.38	9.35	31.07	23.73	56.00	46.00	24.93	22.27	L1	PASS
6	15.9031	24.70	19.36	9.18	33.88	28.54	60.00	50.00	26.12	21.46	L1	PASS

Note: 1. Result (dBµ A) = Reading (dBµ A) + Factor (dB).

2. Factor (dB) = Cable loss (dB) + LISN Factor (dB).

Power supply:	AC 120V/60Hz	Polarization	N
---------------	--------------	--------------	---

Test Graph

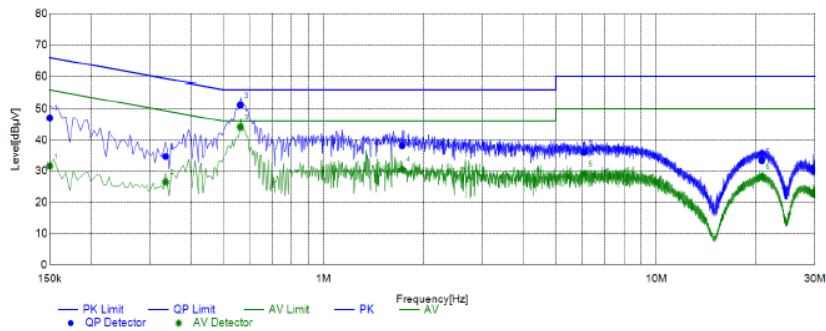

Final Data List												
NO.	Frequency	QP	AVG.	Factor	QP	AVG.	QP	AVG.	QP	AVG.	Line	Remark
		Reading	Reading		Result	Result	Limit	Limit	Margin	Margin		
1	0.1502	37.42	22.08	9.61	47.03	31.69	65.99	55.99	18.96	24.30	N	PASS
2	0.3351	25.25	17.06	9.47	34.72	26.53	59.32	49.32	24.60	22.79	N	PASS
3	0.5622	41.73	34.78	9.40	51.13	44.18	56.00	46.00	4.87	1.82	N	PASS
4	1.7220	28.87	21.21	9.35	38.22	30.56	56.00	46.00	17.78	15.44	N	PASS
5	6.0732	26.67	19.83	9.33	36.00	29.16	60.00	50.00	24.00	20.84	N	PASS
6	20.7964	24.18	19.00	9.23	33.41	28.23	60.00	50.00	26.59	21.77	N	PASS

Note: 1. Result (dBµ A) = Reading (dBµ A) + Factor (dB).

2. Factor (dB) = Cable loss (dB) + LISN Factor (dB).

Adapter: ADS-65HI-19A-1 24060E

Power supply:	AC 120V/60Hz	Polarization	L
---------------	--------------	--------------	---

Test Graph

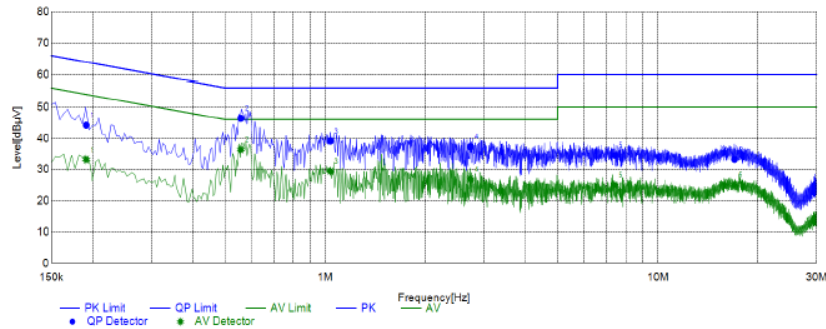

Final Data List												
NO.	Frequency	QP	AVG.	Factor	QP	AVG.	QP	AVG.	QP	AVG.	Line	Remark
		Reading	Reading		Result	Result	Limit	Limit	Margin	Margin		
1	0.1910	34.61	23.61	9.57	44.18	33.18	63.99	53.99	19.81	20.81	L1	PASS
2	0.5570	36.82	26.86	9.57	46.39	36.43	56.00	46.00	9.61	9.57	L1	PASS
3	1.0357	29.76	20.08	9.38	39.14	29.46	56.00	46.00	16.86	16.54	L1	PASS
4	2.7305	28.02	17.64	9.34	37.36	26.98	56.00	46.00	18.64	19.02	L1	PASS
5	7.4150	25.32	15.75	9.28	34.60	25.03	60.00	50.00	25.40	24.97	L1	PASS
6	17.0026	24.09	16.07	9.17	33.26	25.24	60.00	50.00	26.74	24.76	L1	PASS

Note: 1. Result (dBµ A) = Reading (dBµ A) + Factor (dB).

2. Factor (dB) = Cable loss (dB) + LISN Factor (dB).

Power supply:	AC 120V/60Hz	Polarization	N
---------------	--------------	--------------	---

Test Graph

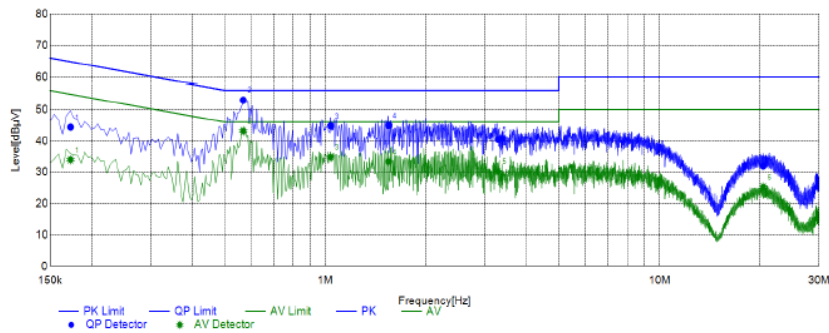

Final Data List												
NO.	Frequency	QP	AVG.	Factor	QP	AVG.	QP	AVG.	QP	AVG.	Line	Remark
		Reading	Reading		Result	Result	Limit	Limit	Margin	Margin		
1	0.1729	34.81	24.37	9.59	44.40	33.96	64.82	54.82	20.42	20.86	N	PASS
2	0.5680	43.59	33.79	9.40	52.99	43.19	56.00	46.00	3.01	2.81	N	PASS
3	1.0372	35.42	25.55	9.36	44.78	34.91	56.00	46.00	11.22	11.09	N	PASS
4	1.5451	35.57	24.00	9.36	44.93	33.36	56.00	46.00	11.07	12.64	N	PASS
5	3.2917	31.11	20.88	9.35	40.46	30.23	56.00	46.00	15.54	15.77	N	PASS
6	20.4195	22.79	16.09	9.23	32.02	25.32	60.00	50.00	27.98	24.68	N	PASS

Note: 1. Result (dBµ A) = Reading (dBµ A) + Factor (dB).

2. Factor (dB) = Cable loss (dB) + LISN Factor (dB).

Version C:
Adapter: CYSE65-240250

Power supply:	AC 120V/60Hz	Polarization	L
---------------	--------------	--------------	---

Test Graph

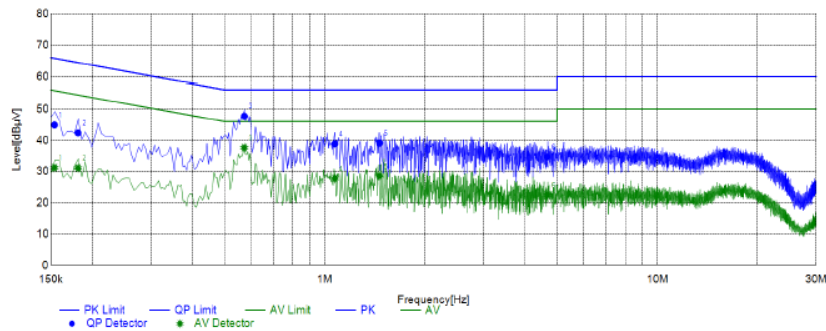

Final Data List												
NO.	Frequency	QP	AVG.	Factor	QP	AVG.	QP	AVG.	QP	AVG.	Line	Remark
		Reading	Reading		Result	Result	Limit	Limit	Margin	Margin		
1	0.1538	35.31	21.67	9.60	44.91	31.27	65.79	55.79	20.88	24.52	L1	PASS
2	0.1812	32.80	21.57	9.59	42.39	31.16	64.43	54.43	22.04	23.27	L1	PASS
3	0.5726	38.09	28.02	9.62	47.71	37.64	56.00	46.00	8.29	8.36	L1	PASS
4	1.0710	29.46	18.39	9.39	38.85	27.78	56.00	46.00	17.15	18.22	L1	PASS
5	1.4608	29.70	19.22	9.38	39.08	28.60	56.00	46.00	16.92	17.40	L1	PASS
6	4.6721	25.32	13.06	9.39	34.71	22.45	56.00	46.00	21.29	23.55	L1	PASS

Note: 1. Result (dBµ A) = Reading (dBµ A) + Factor (dB).

2. Factor (dB) = Cable loss (dB) + LISN Factor (dB).

Power supply:	AC 120V/60Hz	Polarization	N
---------------	--------------	--------------	---

Test Graph

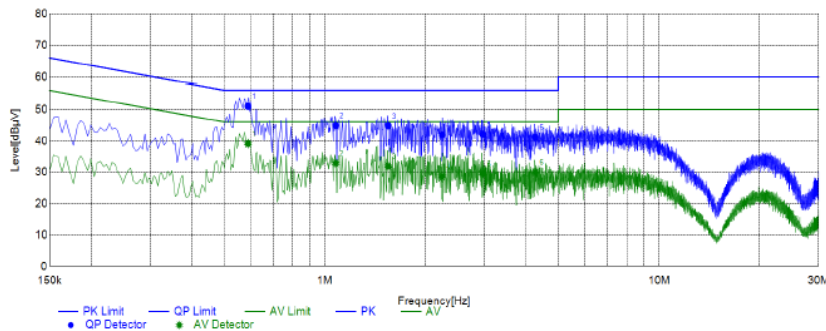

Final Data List												
NO.	Frequency	QP	AVG.	Factor	QP	AVG.	QP	AVG.	QP	AVG.	Line	Remark
		Reading	Reading		Result	Result	Limit	Limit	Margin	Margin		
1	0.5885	41.61	29.69	9.40	51.01	39.09	56.00	46.00	4.99	6.91	N	PASS
2	1.0767	35.48	23.52	9.37	44.85	32.89	56.00	46.00	11.15	13.11	N	PASS
3	1.5469	35.43	22.59	9.36	44.79	31.95	56.00	46.00	11.21	14.05	N	PASS
4	2.2450	32.55	19.30	9.34	41.89	28.64	56.00	46.00	14.11	17.36	N	PASS
5	2.9662	32.78	20.22	9.33	42.11	29.55	56.00	46.00	13.89	16.45	N	PASS
6	4.2613	31.83	20.60	9.38	41.21	29.98	56.00	46.00	14.79	16.02	N	PASS

Note: 1. Result (dBµ A) = Reading (dBµ A) + Factor (dB).

2. Factor (dB) = Cable loss (dB) + LISN Factor (dB).

Adapter: SOY-2400250-332-A

Power supply:	AC 120V/60Hz	Polarization	L
---------------	--------------	--------------	---

Test Graph

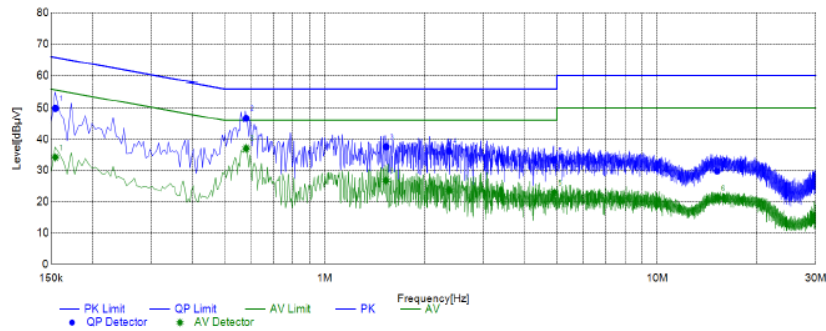

Final Data List												
NO.	Frequency	QP	AVG.	Factor	QP	AVG.	QP	AVG.	QP	AVG.	Line	Remark
		Reading	Reading		Result	Result	Limit	Limit	Margin	Margin		
1	0.1545	40.25	24.60	9.60	49.85	34.20	65.75	55.75	15.90	21.55	L1	PASS
2	0.5798	37.05	27.47	9.64	46.69	37.11	56.00	46.00	9.31	8.89	L1	PASS
3	1.5285	28.23	17.40	9.37	37.60	26.77	56.00	46.00	18.40	19.23	L1	PASS
4	2.3640	26.88	14.32	9.36	36.24	23.68	56.00	46.00	19.76	22.32	L1	PASS
5	4.9012	24.00	13.59	9.36	33.36	22.95	56.00	46.00	22.64	23.05	L1	PASS
6	15.1715	20.64	12.11	9.16	29.80	21.27	60.00	50.00	30.20	28.73	L1	PASS

Note: 1. Result (dBµ A) = Reading (dBµ A) + Factor (dB).

2. Factor (dB) = Cable loss (dB) + LISN Factor (dB).

Power supply:	AC 120V/60Hz	Polarization	N
---------------	--------------	--------------	---

Test Graph

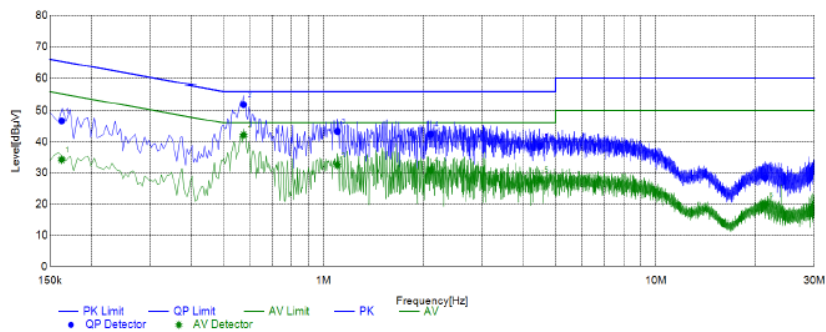

Final Data List												
NO.	Frequency	QP	AVG.	Factor	QP	AVG.	QP	AVG.	QP	AVG.	Line	Remark
		Reading	Reading		Result	Result	Limit	Limit	Margin	Margin		
1	0.1627	37.06	24.64	9.60	46.66	34.24	65.32	55.32	18.66	21.08	N	PASS
2	0.5744	42.46	32.75	9.40	51.86	42.15	56.00	46.00	4.14	3.85	N	PASS
3	1.1009	33.96	23.15	9.37	43.33	32.52	56.00	46.00	12.67	13.48	N	PASS
4	2.0994	33.08	21.59	9.35	42.43	30.94	56.00	46.00	13.57	15.06	N	PASS
5	4.4836	29.21	18.52	9.37	38.58	27.89	56.00	46.00	17.42	18.11	N	PASS
6	21.3323	19.14	10.62	9.24	28.38	19.86	60.00	50.00	31.62	30.14	N	PASS

Note: 1. Result (dBµ A) = Reading (dBµ A) + Factor (dB).

2. Factor (dB) = Cable loss (dB) + LISN Factor (dB).

Adapter: AD65CM249250A

Power supply:	AC 120V/60Hz	Polarization	L
---------------	--------------	--------------	---

Test Graph

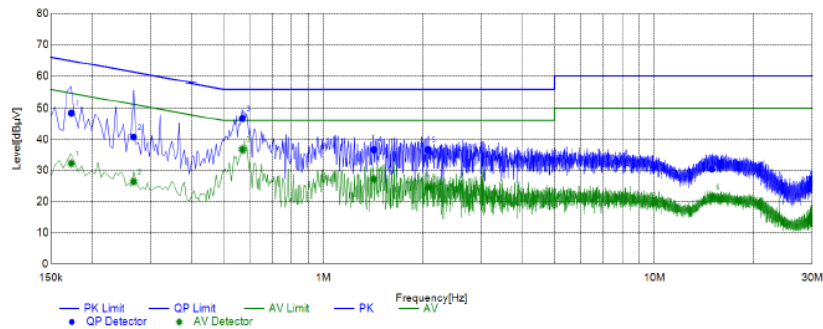

Final Data List												
NO.	Frequency	QP	AVG.	Factor	QP	AVG.	QP	AVG.	QP	AVG.	Line	Remark
		Reading	Reading		Result	Result	Limit	Limit	Margin	Margin		
1	0.1731	38.88	22.67	9.59	48.47	32.26	64.81	54.81	16.34	22.55	L1	PASS
2	0.2671	31.27	16.95	9.47	40.74	26.42	61.21	51.21	20.47	24.79	L1	PASS
3	0.5688	37.09	27.24	9.61	46.70	36.85	56.00	46.00	9.30	9.15	L1	PASS
4	1.4218	27.34	17.80	9.38	36.72	27.18	56.00	46.00	19.28	18.82	L1	PASS
5	2.0708	27.36	15.33	9.35	36.71	24.68	56.00	46.00	19.29	21.32	L1	PASS
6	14.9384	21.24	12.43	9.17	30.41	21.60	60.00	50.00	29.59	28.40	L1	PASS

Note: 1. Result (dBµ A) = Reading (dBµ A) + Factor (dB).

2. Factor (dB) = Cable loss (dB) + LISN Factor (dB).

Power supply:	AC 120V/60Hz	Polarization	N
---------------	--------------	--------------	---

Test Graph

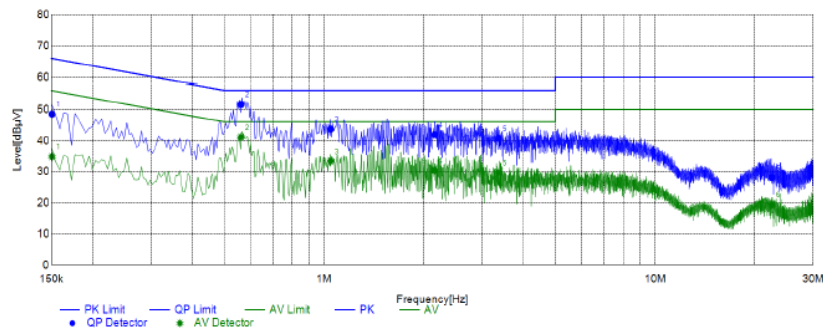

Final Data List												
NO.	Frequency	QP	AVG.	Factor	QP	AVG.	QP	AVG.	QP	AVG.	Line	Remark
		Reading	Reading		Result	Result	Limit	Limit	Margin	Margin		
1	0.1508	38.92	25.23	9.61	48.53	34.84	65.96	55.96	17.43	21.12	N	PASS
2	0.5615	42.23	31.72	9.40	51.63	41.12	56.00	46.00	4.37	4.88	N	PASS
3	1.0466	34.35	24.02	9.36	43.71	33.38	56.00	46.00	12.29	12.62	N	PASS
4	2.1564	32.58	21.15	9.33	41.91	30.48	56.00	46.00	14.09	15.52	N	PASS
5	3.3675	31.40	20.35	9.35	40.75	29.70	56.00	46.00	15.25	16.30	N	PASS
6	22.5347	18.86	10.16	9.24	28.10	19.40	60.00	50.00	31.90	30.60	N	PASS

Note: 1. Result (dBµ A) = Reading (dBµ A) + Factor (dB).

2. Factor (dB) = Cable loss (dB) + LISN Factor (dB).

Adapter: ADS-65HI-19A-1 24060E

Power supply:	AC 120V/60Hz	Polarization	L
---------------	--------------	--------------	---

Test Graph

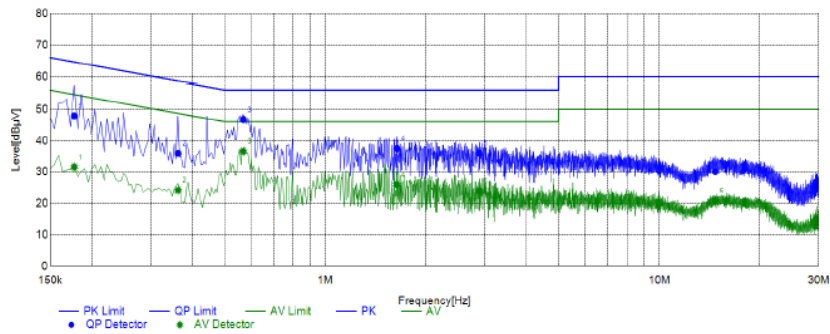

Final Data List												
NO.	Frequency	QP	AVG.	Factor	QP	AVG.	QP	AVG.	QP	AVG.	Line	Remark
		Reading	Reading		Result	Result	Limit	Limit	Margin	Margin		
1	0.1770	38.26	22.01	9.59	47.85	31.60	64.63	54.63	16.78	23.03	L1	PASS
2	0.3623	26.52	14.75	9.43	35.95	24.18	58.68	48.68	22.73	24.50	L1	PASS
3	0.5682	37.08	27.04	9.60	46.68	36.64	56.00	46.00	9.32	9.36	L1	PASS
4	1.6396	28.13	16.67	9.37	37.50	26.04	56.00	46.00	18.50	19.96	L1	PASS
5	2.8894	26.64	14.67	9.35	35.99	24.02	56.00	46.00	20.01	21.98	L1	PASS
6	14.7242	20.98	11.80	9.17	30.15	20.97	60.00	50.00	29.85	29.03	L1	PASS

Note: 1. Result (dBµ A) = Reading (dBµ A) + Factor (dB).

2. Factor (dB) = Cable loss (dB) + LISN Factor (dB).

Power supply:	AC 120V/60Hz	Polarization	N
---------------	--------------	--------------	---

Test Graph

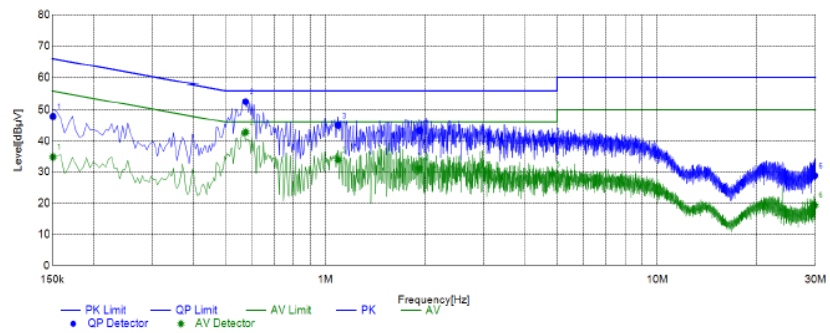

Final Data List												
NO.	Frequency	QP	AVG.	Factor	QP	AVG.	QP	AVG.	QP	AVG.	Line	Remark
		Reading	Reading		Result	Result	Limit	Limit	Margin	Margin		
1	0.1510	38.24	25.25	9.61	47.85	34.86	65.95	55.95	18.10	21.09	N	PASS
2	0.5746	43.16	33.44	9.40	52.56	42.84	56.00	46.00	3.44	3.16	N	PASS
3	1.0939	35.63	24.50	9.37	45.00	33.87	56.00	46.00	11.00	12.13	N	PASS
4	1.9229	34.03	21.93	9.34	43.37	31.27	56.00	46.00	12.63	14.73	N	PASS
5	4.8286	30.75	19.99	9.34	40.09	29.33	56.00	46.00	15.91	16.67	N	PASS
6	29.8939	19.59	10.16	9.25	28.84	19.41	60.00	50.00	31.16	30.59	N	PASS

Note: 1. Result (dBµ A) = Reading (dBµ A) + Factor (dB).

2. Factor (dB) = Cable loss (dB) + LISN Factor (dB).

4.2. Radiated Emission

TEST CONFIGURATION

Frequency range 9 KHz – 30MHz

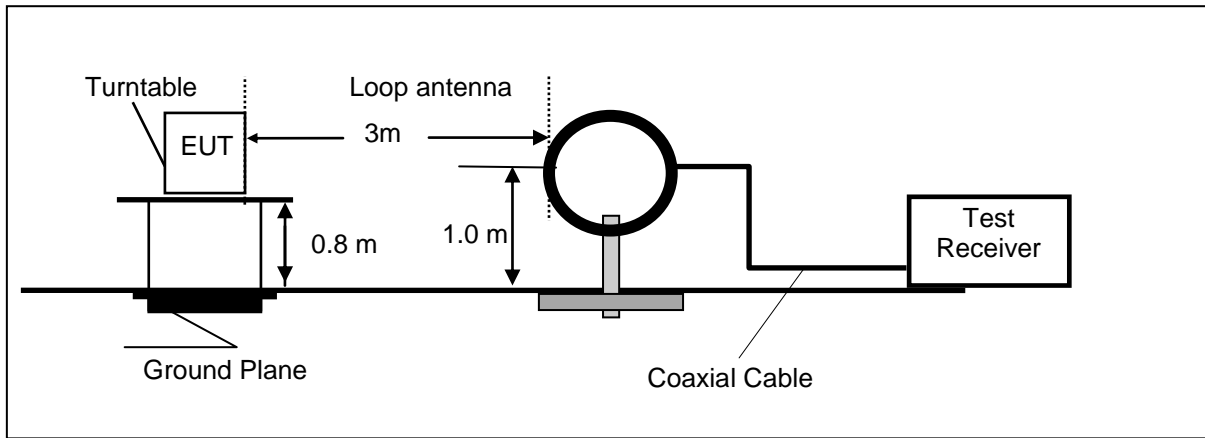

Frequency range 30MHz – 1000MHz

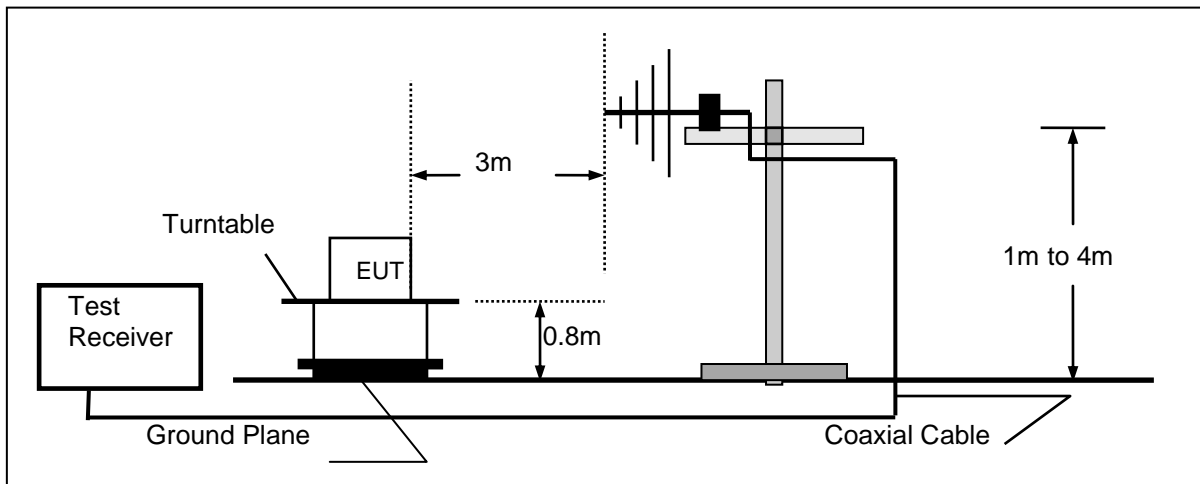

Frequency range above 1GHz-25GHz

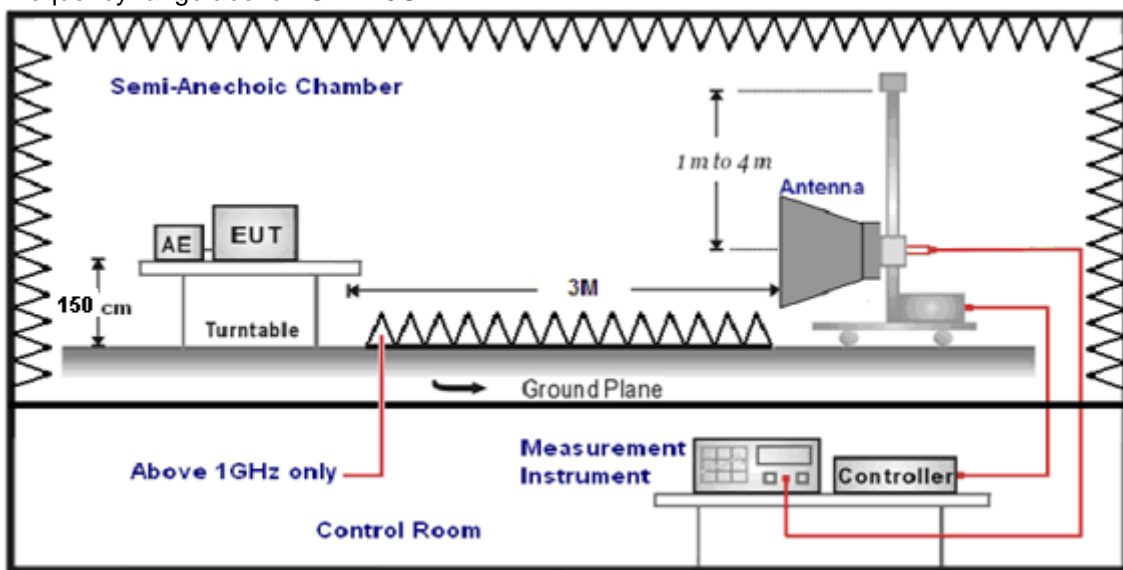

TEST PROCEDURE

1. The EUT was placed on a turn table which is 0.8m above ground plane when testing frequency range 30MHz –1GHz;the EUT was placed on a turn table which is 1.5m above ground plane when testing frequency range 1GHz – 25GHz.
2. Maximum procedure was performed by raising the receiving antenna from 1m to 4m and rotating the turn table from 0° to 360° to acquire the highest emissions from EUT.
3. And also, each emission was to be maximized by changing the polarization of receiving antenna both horizontal and vertical.
4. Repeat above procedures until all frequency measurements have been completed.
5. Radiated emission test frequency band from 30MHz to 25GHz.
6. The distance between test antenna and EUT as following table states:

Test Frequency range	Test Antenna Type	Test Distance
9KHz-30MHz	Active Loop Antenna	3
30MHz-1GHz	Ultra-Broadband Antenna	3
1GHz-18GHz	Double Ridged Horn Antenna	3
18GHz-25GHz	Horn Antenna	1

7. Setting test receiver/spectrum as following table states:

Test Frequency range	Test Receiver/Spectrum Setting	Detector
9KHz-150KHz	RBW=200Hz/VBW=3KHz,Sweep time=Auto	QP
150KHz-30MHz	RBW=9KHz/VBW=100KHz,Sweep time=Auto	QP
30MHz-1GHz	RBW=120KHz/VBW=1000KHz,Sweep time=Auto	QP
1GHz-40GHz	Peak Value: RBW=1MHz/VBW=3MHz, Sweep time=Auto Average Value: RBW=1MHz/VBW=10Hz, Sweep time=Auto	Peak

Field Strength Calculation

The field strength is calculated by adding the Antenna Factor and Cable Factor and subtracting the Amplifier Gain and Duty Cycle Correction Factor(if any) from the measured reading. The basic equation with a sample calculation is as follows:

$$FS = RA + AF + CL - AG$$

Where FS = Field Strength	CL = Cable Attenuation Factor (Cable Loss)
RA = Reading Amplitude	AG = Amplifier Gain
AF = Antenna Factor	

$$Transd=AF +CL-AG$$

RADIATION LIMIT

For intentional device, according to § 15.209(a), the general requirement of field strength of radiated emission from intentional radiators at a distance of 3 meters shall not exceed the following table. According to § 15.247(d), in any 100kHz bandwidth outside the frequency band in which the EUT is operating, the radio frequency power that is produced by the intentional radiator shall be at least 20dB below that in the 100kHz bandwidth within the band that contains the highest level of desired power.

The pre-test have done for the EUT in three axes and found the worst emission at position shown in test setup photos.

Frequency (MHz)	Distance (Meters)	Radiated (dB μ V/m)	Radiated (μ V/m)
0.009-0.49	3	$20\log(2400/F(\text{KHz}))+40\log(300/3)$	2400/F(KHz)
0.49-1.705	3	$20\log(24000/F(\text{KHz}))+40\log(30/3)$	24000/F(KHz)
1.705-30	3	$20\log(30)+40\log(30/3)$	30
30-88	3	40.0	100
88-216	3	43.5	150
216-960	3	46.0	200
Above 960	3	54.0	500

TEST RESULTS

Remark: We measured Radiated Emission at 802.11b/802.11g/802.11n HT20/802.11n HT40/802.11ax HE20/802.11ax HE40 mode from 9KHz to 25GHz in AC120V and the worst case was recorded.

Temperature	25°C	Humidity	60%
Test Engineer	Jenny Zeng	Configurations	IEEE 802.11g (MCH)

For 9 KHz~30MHz

Freq. (MHz)	Level (dB μ V)	Over Limit (dB)	Over Limit (dB μ V)	Remark
-	-	-	-	See Note

Note:

The amplitude of spurious emissions which are attenuated by more than 20 dB below the permissible value has no need to be reported.

Distance extrapolation factor = $40 \log(\text{specific distance} / \text{test distance})$ (dB);

Limit line = specific limits (dB μ V) + distance extrapolation factor.

For 30MHz-1GHz
Version A:

Adapter: CYSE65-240250

Horizontal

Test Graph

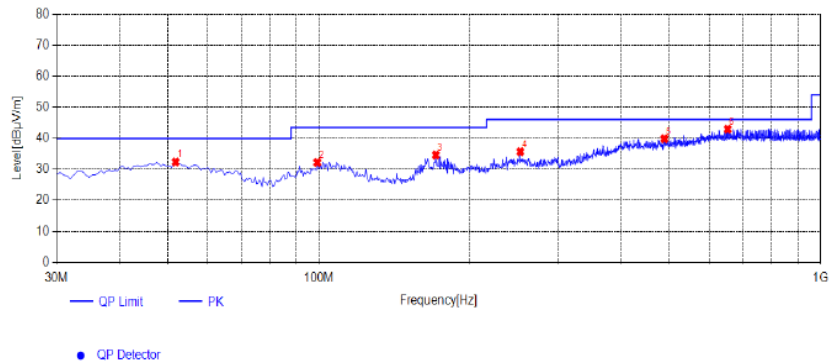

Suspected List

NO.	Frequency [MHz]	Reading [dBµV/m]	Factor [dB]	Result [dBµV/m]	Limit [dBµV/m]	Margin [dB]	Height [cm]	Angle [°]	Detector	Polarity	Remark
1	51.825	43.69	-11.33	32.36	40.00	7.64	100	357	PK	Horizontal	PASS
2	99.355	44.75	-12.55	32.20	43.50	11.30	100	24	PK	Horizontal	PASS
3	171.135	49.31	-14.74	34.57	43.50	8.93	100	288	PK	Horizontal	PASS
4	252.13	46.47	-10.83	35.64	46.00	10.36	100	268	PK	Horizontal	PASS
5	488.325	42.87	-3.01	39.86	46.00	6.14	100	209	PK	Horizontal	PASS
6	653.225	43.48	-0.53	42.95	46.00	3.05	100	202	PK	Horizontal	PASS

Note: 1. Result (dBµV/m) = Reading(dBµV/m) + Factor (dB) .

2. Factor (dB) = Antenna Factor (dB/m) + Cable loss (dB) - Pre Amplifier gain (dB).

Vertical

Test Graph

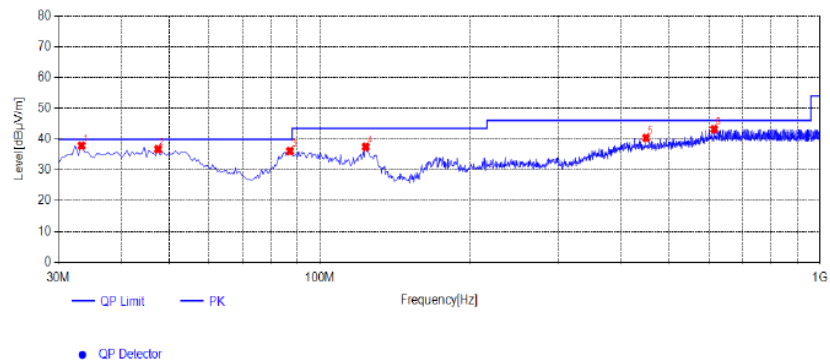

Suspected List

NO.	Frequency [MHz]	Reading [dBµV/m]	Factor [dB]	Result [dBµV/m]	Limit [dBµV/m]	Margin [dB]	Height [cm]	Angle [°]	Detector	Polarity	Remark
1	33.395	52.35	-14.52	37.83	40.00	2.17	100	84	PK	Vertical	PASS
2	47.46	47.88	-11.21	36.67	40.00	3.33	100	358	PK	Vertical	PASS
3	87.23	51.04	-14.97	36.07	40.00	3.93	100	312	PK	Vertical	PASS
4	123.605	51.89	-14.47	37.42	43.50	6.08	100	117	PK	Vertical	PASS
5	449.04	43.80	-3.39	40.41	46.00	5.59	100	1	PK	Vertical	PASS
6	614.425	44.52	-1.31	43.21	46.00	2.79	100	54	PK	Vertical	PASS

Note: 1. Result (dBµV/m) = Reading(dBµV/m) + Factor (dB) .

2. Factor (dB) = Antenna Factor (dB/m) + Cable loss (dB) - Pre Amplifier gain (dB).

Adapter: SOY-2400250-332-A

Horizontal

Test Graph

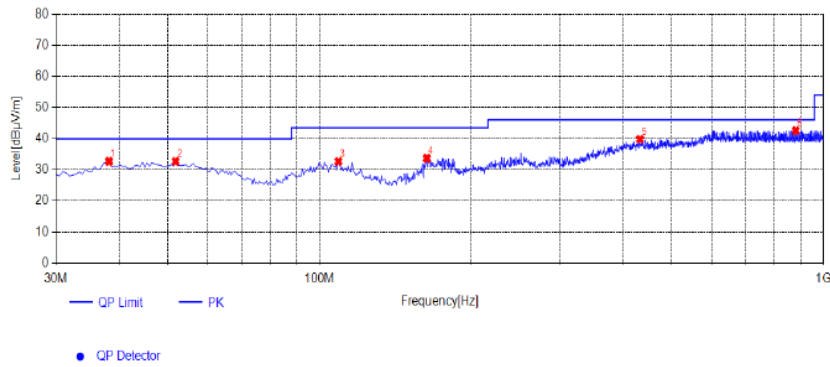

Suspected List											
NO.	Frequency [MHz]	Reading [dBµV/m]	Factor [dB]	Result [dBµV/m]	Limit [dBµV/m]	Margin [dB]	Height [cm]	Angle [°]	Detector	Polarity	Remark
1	38.245	46.08	-13.39	32.69	40.00	7.31	100	230	PK	Horizontal	PASS
2	51.825	44.01	-11.33	32.68	40.00	7.32	100	348	PK	Horizontal	PASS
3	109.055	45.01	-12.35	32.66	43.50	10.84	100	302	PK	Horizontal	PASS
4	163.375	48.37	-14.71	33.66	43.50	9.84	100	272	PK	Horizontal	PASS
5	432.55	42.99	-3.17	39.82	46.00	6.18	100	256	PK	Horizontal	PASS
6	881.175	40.52	2.08	42.60	46.00	3.40	100	12	PK	Horizontal	PASS

Note: 1. Result (dBµV/m) = Reading(dBµV/m) + Factor (dB) .

2. Factor (dB) = Antenna Factor (dB/m) + Cable loss (dB) - Pre Amplifier gain (dB).

Vertical

Test Graph

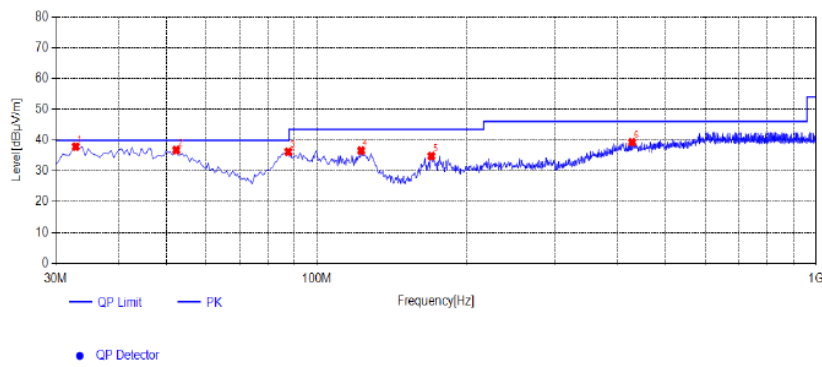

Suspected List											
NO.	Frequency [MHz]	Reading [dBµV/m]	Factor [dB]	Result [dBµV/m]	Limit [dBµV/m]	Margin [dB]	Height [cm]	Angle [°]	Detector	Polarity	Remark
1	32.91	52.25	-14.42	37.83	40.00	2.17	100	346	PK	Vertical	PASS
2	52.31	47.99	-11.29	36.70	40.00	3.30	100	356	PK	Vertical	PASS
3	87.715	51.31	-15.15	36.16	40.00	3.84	100	310	PK	Vertical	PASS
4	122.635	50.85	-14.30	36.55	43.50	6.95	100	154	PK	Vertical	PASS
5	169.68	49.62	-14.83	34.79	43.50	8.71	100	304	PK	Vertical	PASS
6	428.185	42.76	-3.45	39.31	46.00	6.69	100	320	PK	Vertical	PASS

Note: 1. Result (dBµV/m) = Reading(dBµV/m) + Factor (dB) .

2. Factor (dB) = Antenna Factor (dB/m) + Cable loss (dB) - Pre Amplifier gain (dB).

Adapter: AD65CM249250A

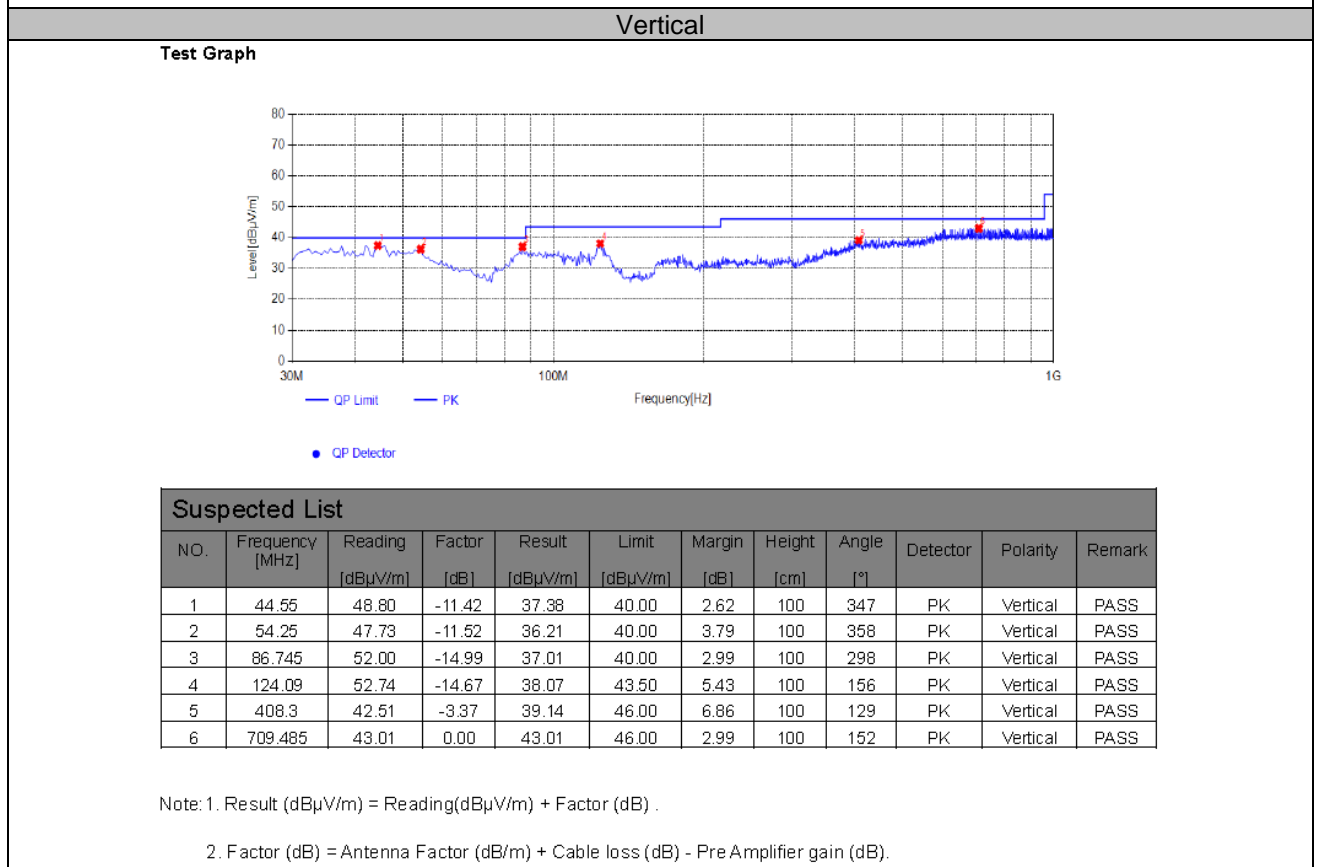
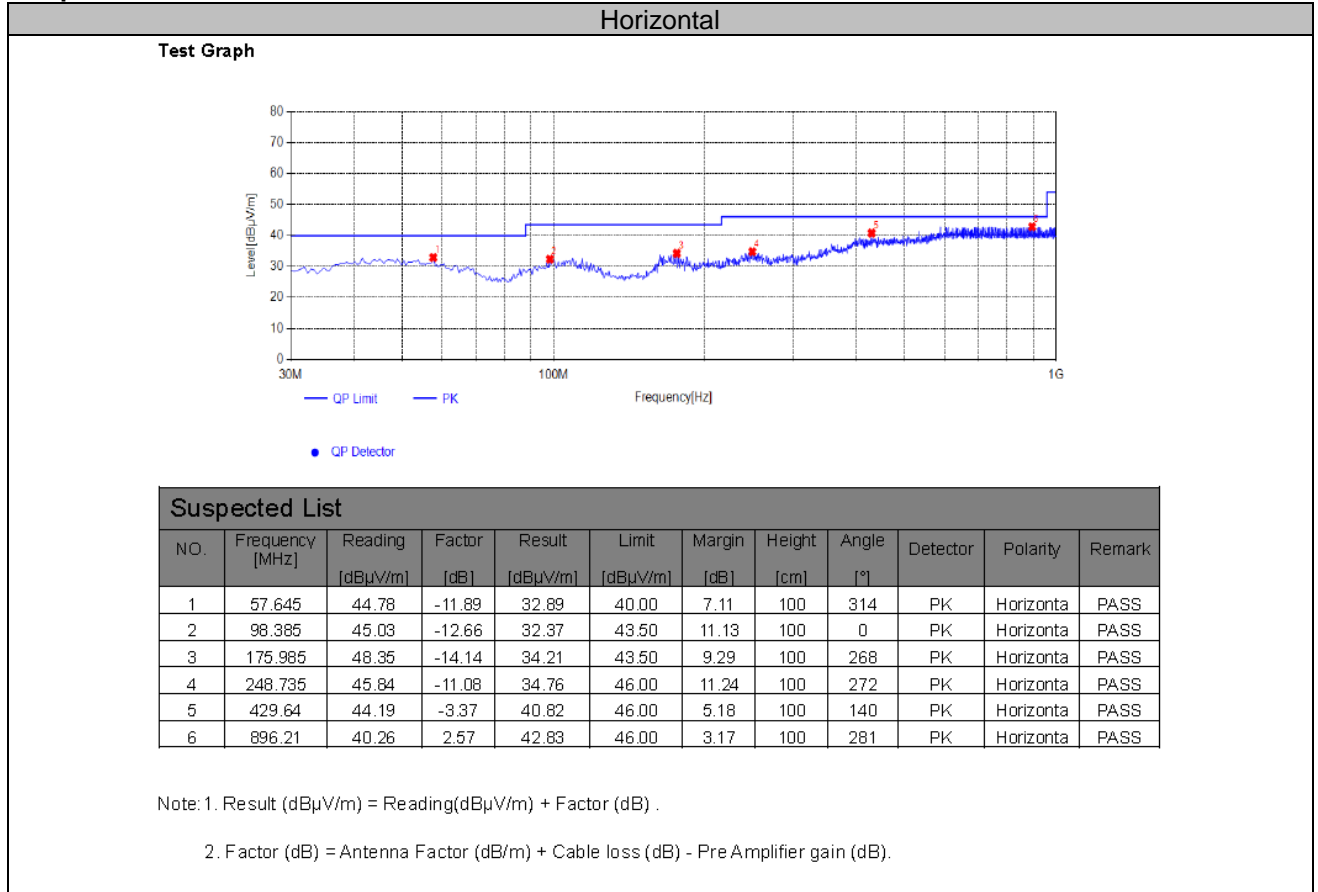

Adapter: ADS-65HI-19A-1 24060E

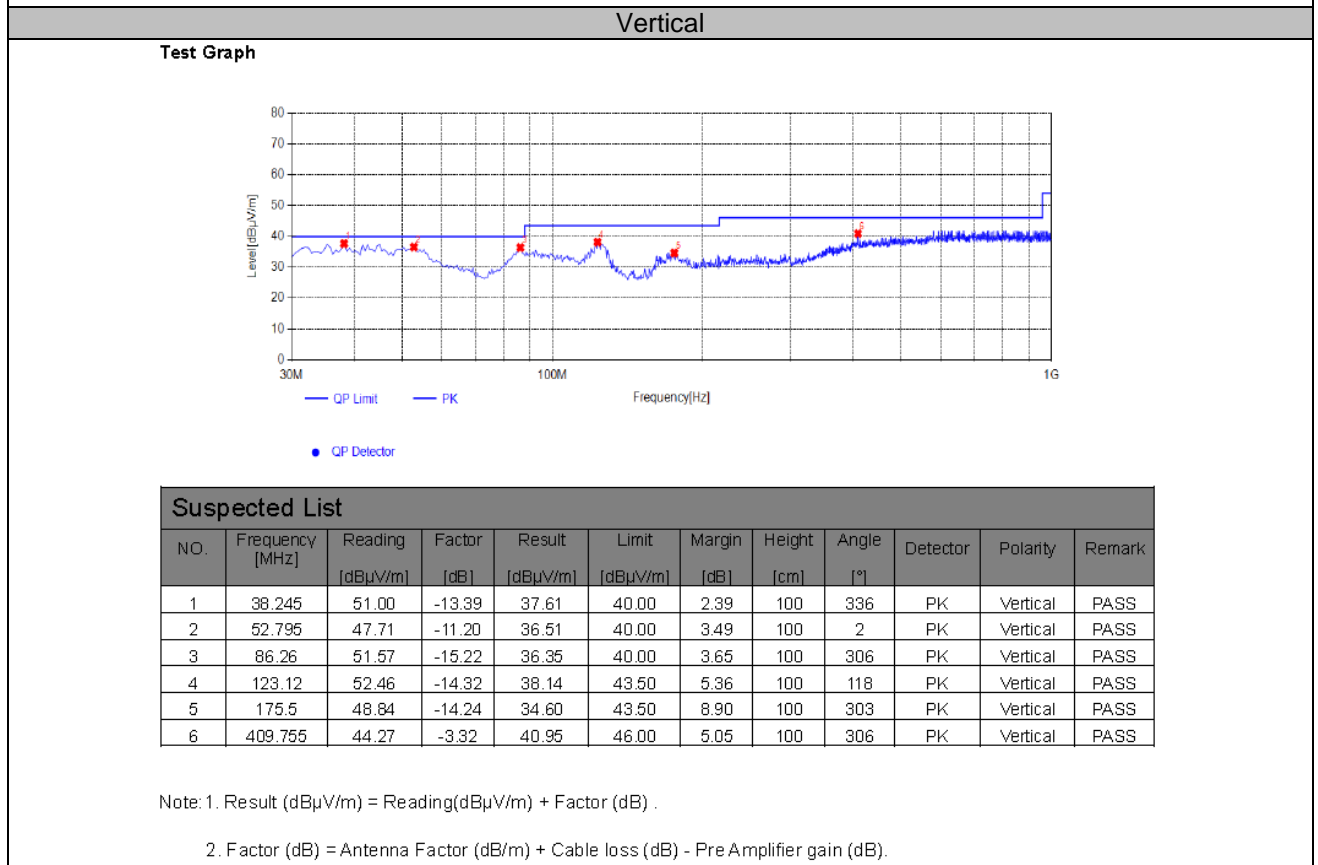
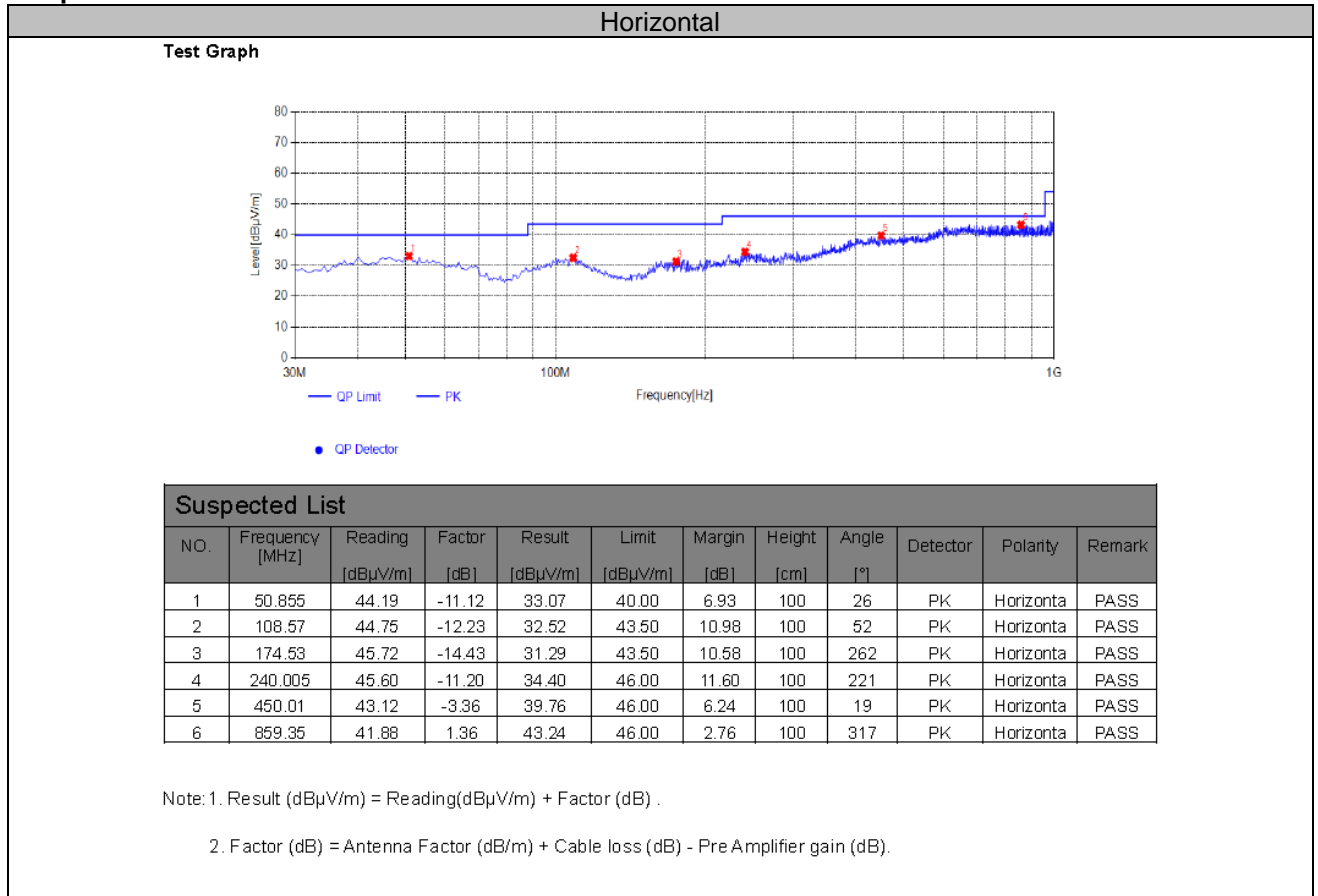

Version B:

Adapter: CYSE65-240250

Horizontal

Test Graph

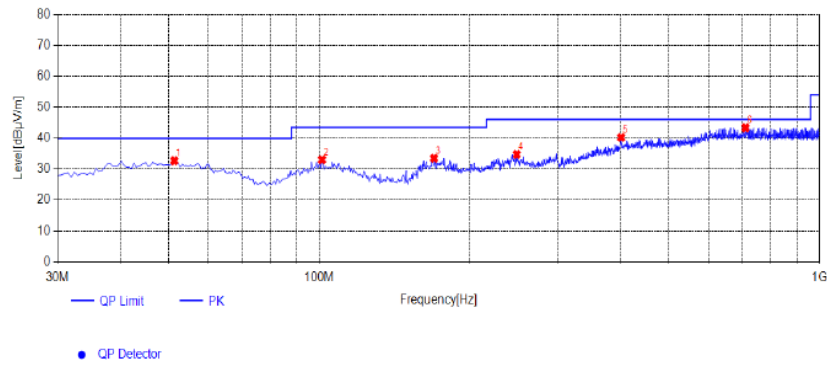

Suspected List											
NO.	Frequency [MHz]	Reading [dBµV/m]	Factor [dB]	Result [dBµV/m]	Limit [dBµV/m]	Margin [dB]	Height [cm]	Angle [°]	Detector	Polarity	Remark
1	51.34	43.82	-11.12	32.70	40.00	7.30	100	110	PK	Horizontal	PASS
2	101.295	45.71	-12.70	33.01	43.50	10.49	100	34	PK	Horizontal	PASS
3	169.68	48.31	-14.83	33.48	43.50	10.02	100	261	PK	Horizontal	PASS
4	248.25	45.80	-11.08	34.72	46.00	11.28	100	282	PK	Horizontal	PASS
5	401.51	43.97	-3.73	40.24	46.00	5.76	100	77	PK	Horizontal	PASS
6	711.425	43.35	0.01	43.36	46.00	2.64	100	222	PK	Horizontal	PASS

Note: 1. Result (dBµV/m) = Reading(dBµV/m) + Factor (dB) .

2. Factor (dB) = Antenna Factor (dB/m) + Cable loss (dB) - Pre Amplifier gain (dB).

Vertical

Test Graph

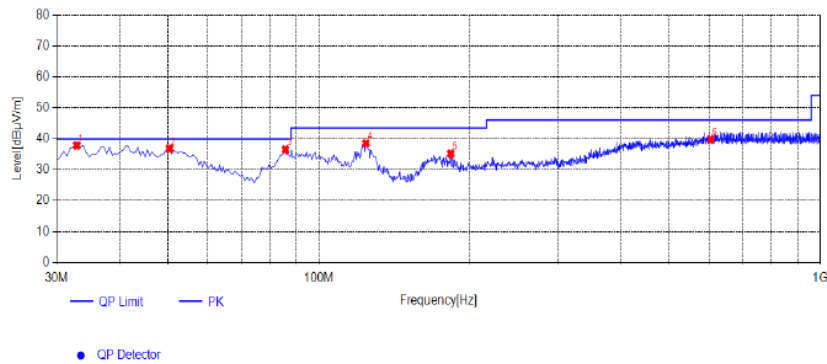

Suspected List											
NO.	Frequency [MHz]	Reading [dBµV/m]	Factor [dB]	Result [dBµV/m]	Limit [dBµV/m]	Margin [dB]	Height [cm]	Angle [°]	Detector	Polarity	Remark
1	32.91	52.21	-14.42	37.79	40.00	2.21	100	32	PK	Vertical	PASS
2	50.37	47.89	-11.11	36.78	40.00	3.22	100	22	PK	Vertical	PASS
3	85.775	51.91	-15.44	36.47	40.00	3.53	100	277	PK	Vertical	PASS
4	124.09	53.21	-14.67	38.54	43.50	4.96	100	141	PK	Vertical	PASS
5	183.26	48.81	-13.68	35.13	43.50	8.37	100	277	PK	Vertical	PASS
6	605.21	40.48	-0.71	39.77	46.00	3.67	100	69	PK	Vertical	PASS

Note: 1. Result (dBµV/m) = Reading(dBµV/m) + Factor (dB) .

2. Factor (dB) = Antenna Factor (dB/m) + Cable loss (dB) - Pre Amplifier gain (dB).

Adapter: SOY-2400250-332-A

Horizontal

Test Graph

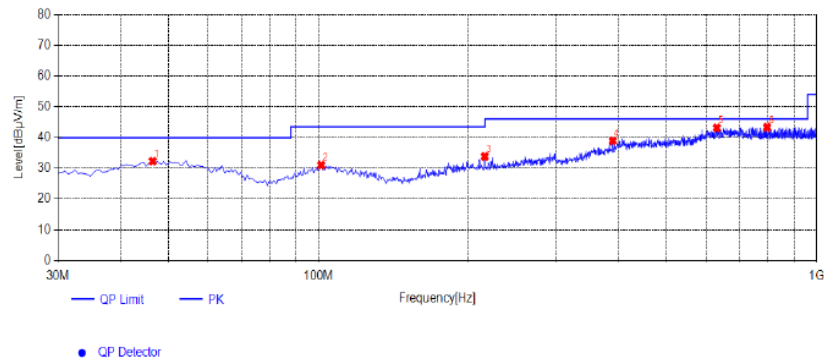

Suspected List

NO.	Frequency [MHz]	Reading [dBµV/m]	Factor [dB]	Result [dBµV/m]	Limit [dBµV/m]	Margin [dB]	Height [cm]	Angle [°]	Detector	Polarity	Remark
1	46.49	43.49	-11.17	32.32	40.00	7.68	100	164	PK	Horizontal	PASS
2	101.295	43.75	-12.70	31.05	43.50	12.45	100	277	PK	Horizontal	PASS
3	215.755	46.20	-12.37	33.83	43.50	9.67	100	26	PK	Horizontal	PASS
4	389.87	43.73	-4.81	38.92	46.00	7.08	100	343	PK	Horizontal	PASS
5	630.43	44.24	-1.07	43.17	46.00	2.83	100	217	PK	Horizontal	PASS
6	795.815	41.77	1.58	43.35	46.00	2.65	100	9	PK	Horizontal	PASS

Note: 1. Result (dBµV/m) = Reading(dBµV/m) + Factor (dB) .

2. Factor (dB) = Antenna Factor (dB/m) + Cable loss (dB) - Pre Amplifier gain (dB).

Vertical

Test Graph

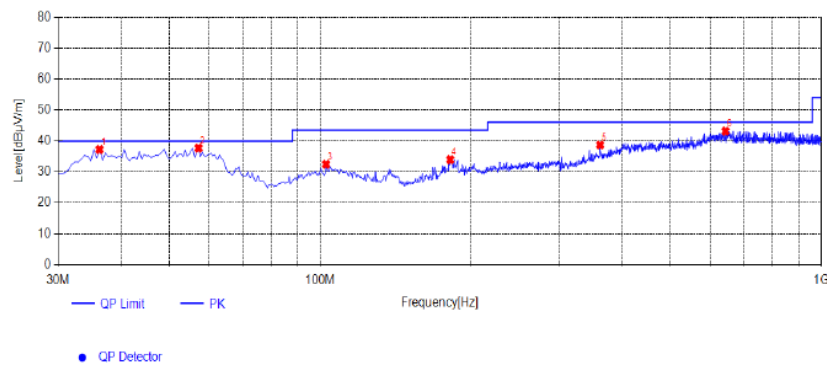

Suspected List

NO.	Frequency [MHz]	Reading [dBµV/m]	Factor [dB]	Result [dBµV/m]	Limit [dBµV/m]	Margin [dB]	Height [cm]	Angle [°]	Detector	Polarity	Remark
1	36.305	51.47	-14.28	37.19	40.00	2.81	100	21	PK	Vertical	PASS
2	57.16	49.19	-11.57	37.62	40.00	2.38	100	358	PK	Vertical	PASS
3	102.75	44.88	-12.42	32.46	43.50	11.04	100	263	PK	Vertical	PASS
4	181.805	48.18	-14.25	33.93	43.50	9.57	100	166	PK	Vertical	PASS
5	361.74	44.38	-5.70	38.68	46.00	7.32	100	144	PK	Vertical	PASS
6	644.01	44.24	-1.08	43.16	46.00	2.84	100	140	PK	Vertical	PASS

Note: 1. Result (dBµV/m) = Reading(dBµV/m) + Factor (dB) .

2. Factor (dB) = Antenna Factor (dB/m) + Cable loss (dB) - Pre Amplifier gain (dB).

Adapter: AD65CM249250A

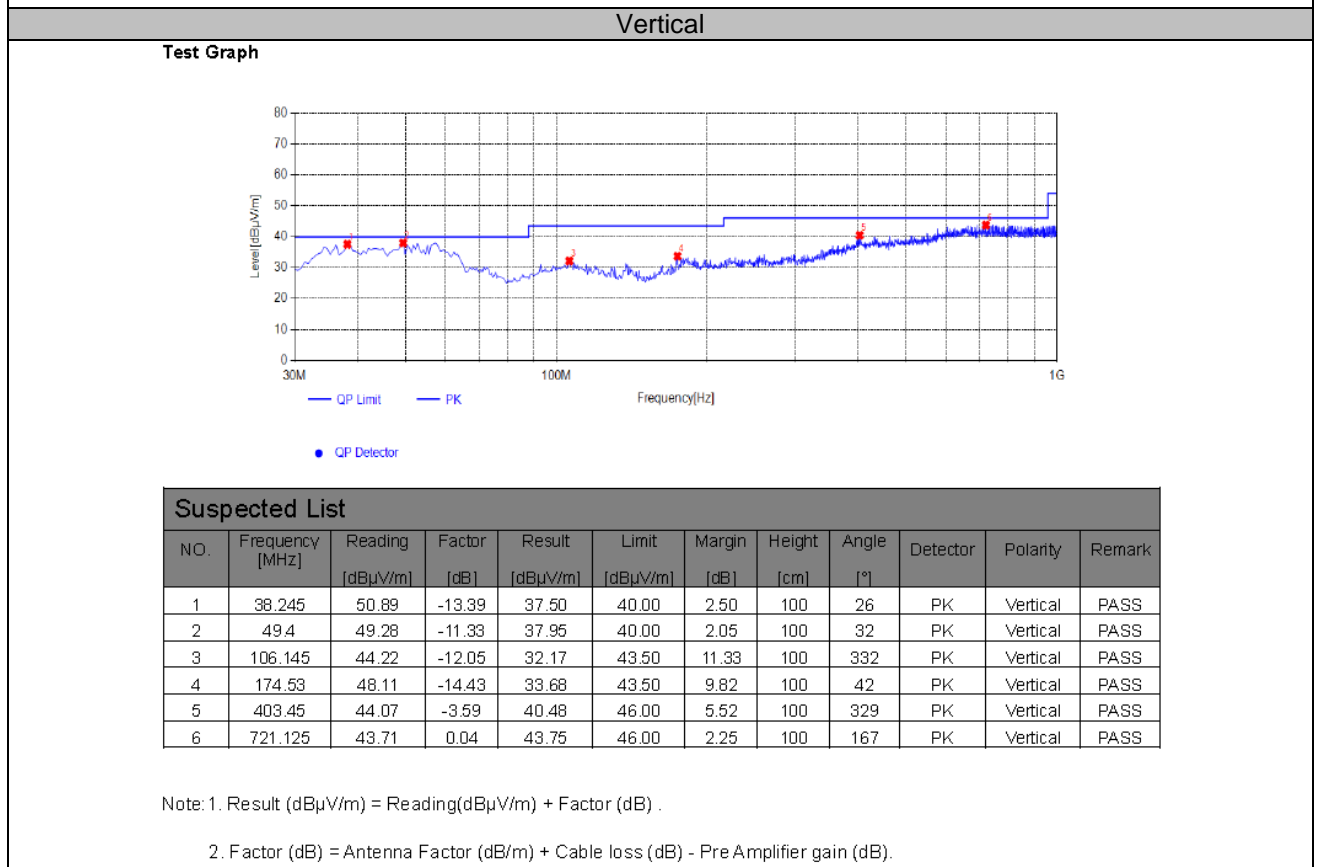
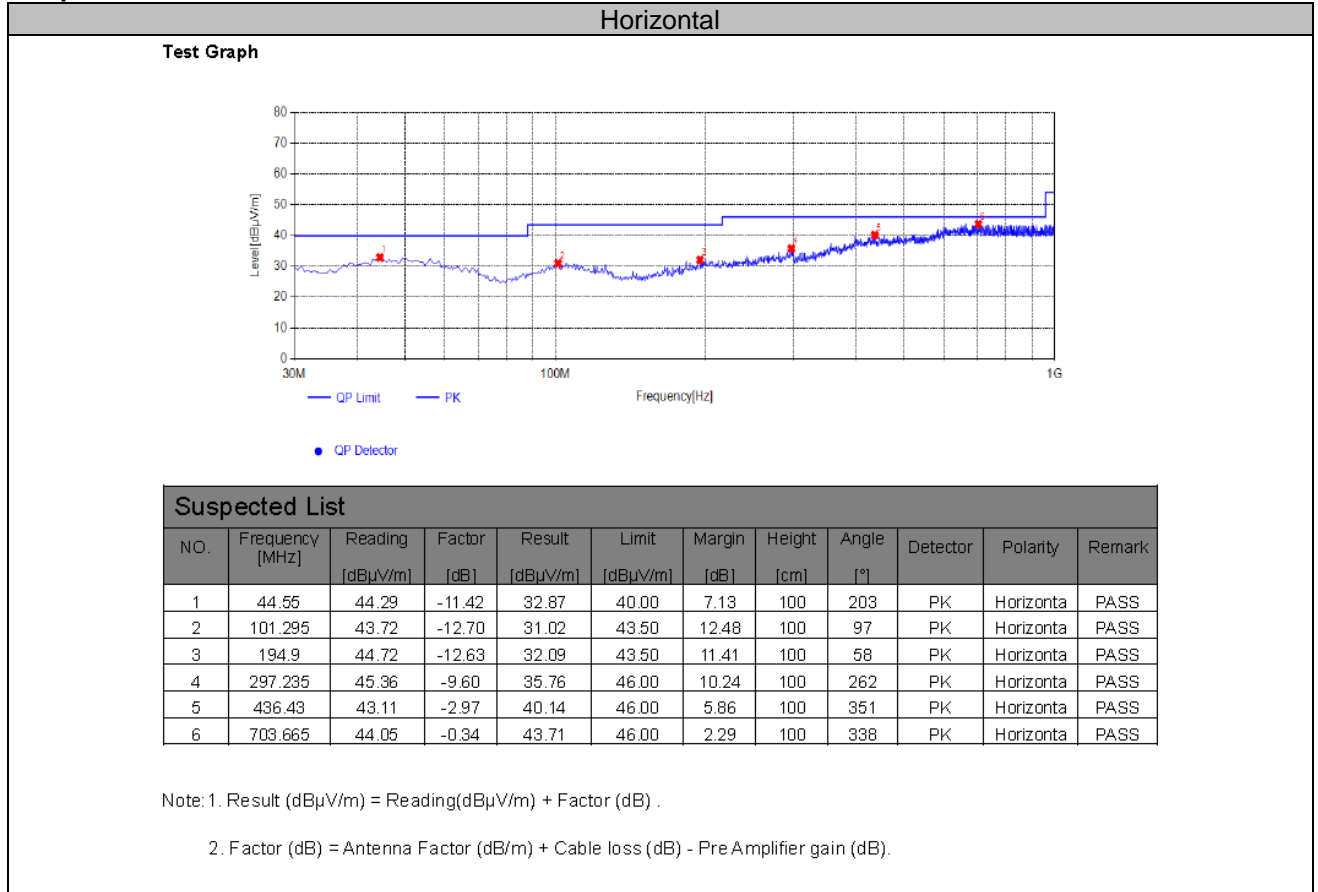

Adapter: ADS-65HI-19A-1 24060E

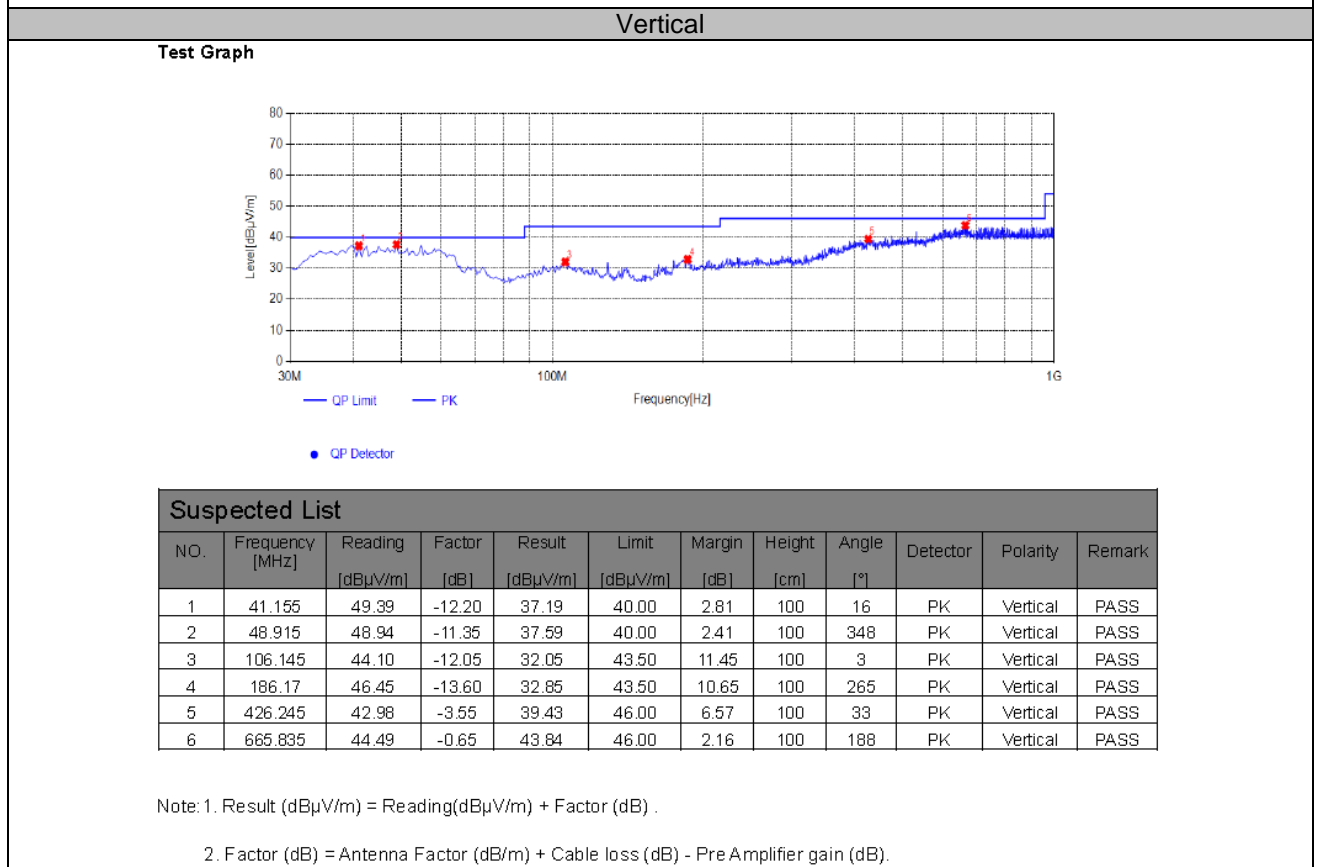
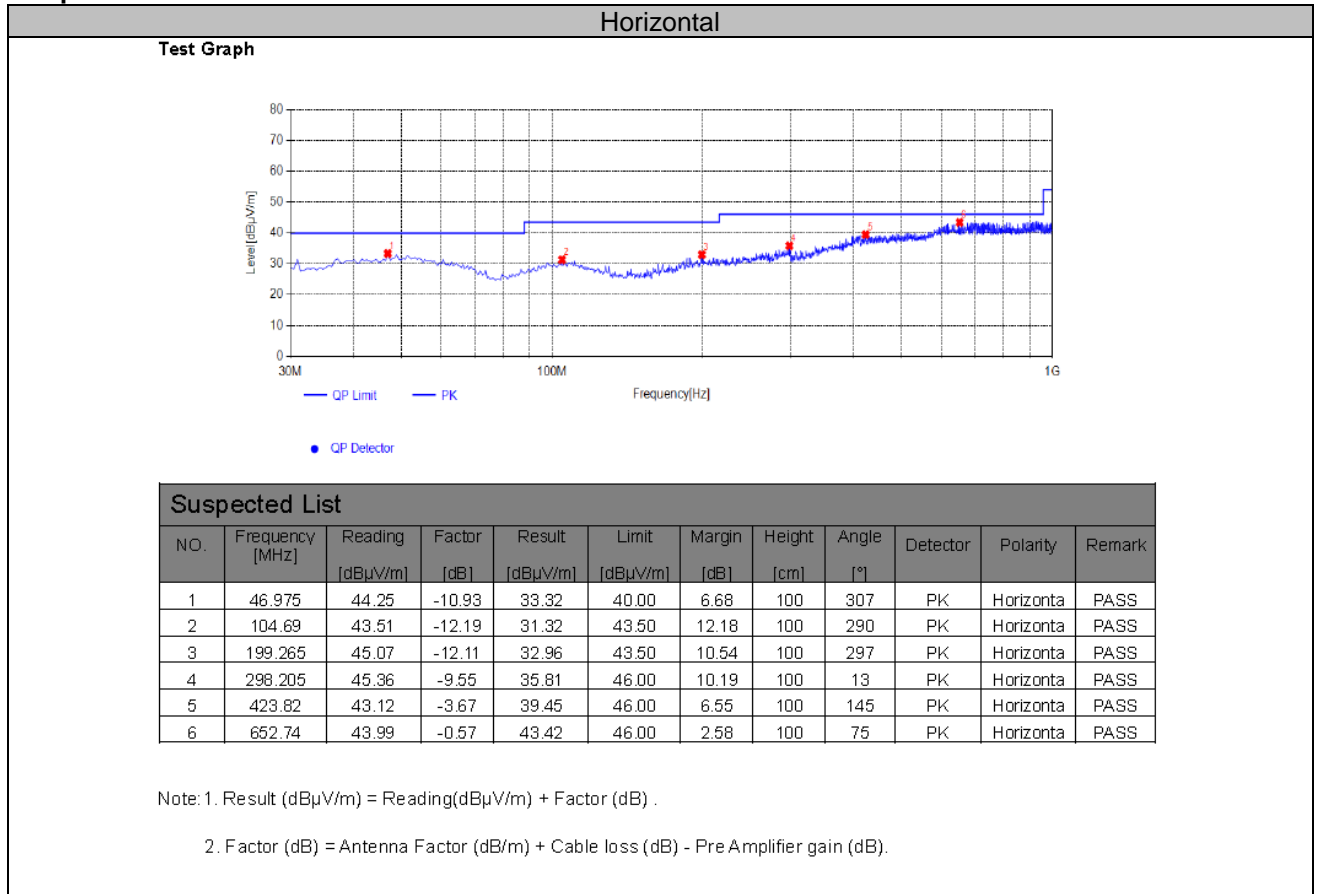

Version C:

Adapter: CYSE65-240250

Horizontal

Test Graph

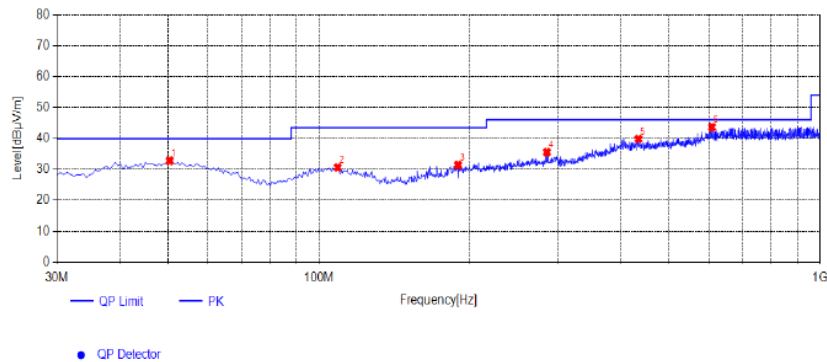

Suspected List

NO.	Frequency [MHz]	Reading [dBµV/m]	Factor [dB]	Result [dBµV/m]	Limit [dBµV/m]	Margin [dB]	Height [cm]	Angle [°]	Detector	Polarity	Remark
1	50.37	43.94	-11.11	32.83	40.00	7.17	100	212	PK	Horizontal	PASS
2	109.055	43.00	-12.35	30.65	43.50	12.85	100	112	PK	Horizontal	PASS
3	189.565	44.86	-13.45	31.41	43.50	12.09	100	249	PK	Horizontal	PASS
4	285.11	45.60	-10.07	35.53	46.00	10.47	100	256	PK	Horizontal	PASS
5	434.005	42.92	-3.06	39.86	46.00	6.14	100	259	PK	Horizontal	PASS
6	608.605	44.70	-1.07	43.63	46.00	2.37	100	308	PK	Horizontal	PASS

Note: 1. Result (dBµV/m) = Reading(dBµV/m) + Factor (dB) .

2. Factor (dB) = Antenna Factor (dB/m) + Cable loss (dB) - Pre Amplifier gain (dB).

Vertical

Test Graph

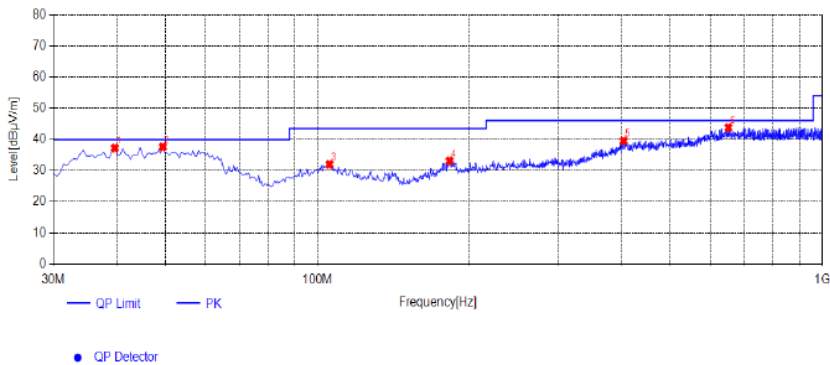

Suspected List

NO.	Frequency [MHz]	Reading [dBµV/m]	Factor [dB]	Result [dBµV/m]	Limit [dBµV/m]	Margin [dB]	Height [cm]	Angle [°]	Detector	Polarity	Remark
1	39.7	49.64	-12.66	37.18	40.00	2.82	100	34	PK	Vertical	PASS
2	49.4	48.87	-11.33	37.54	40.00	2.46	100	93	PK	Vertical	PASS
3	105.66	44.10	-12.11	31.99	43.50	11.51	100	34	PK	Vertical	PASS
4	182.775	46.92	-13.82	33.10	43.50	10.40	100	120	PK	Vertical	PASS
5	403.935	43.09	-3.55	39.54	46.00	6.46	100	162	PK	Vertical	PASS
6	651.77	44.42	-0.63	43.79	46.00	2.21	100	96	PK	Vertical	PASS

Note: 1. Result (dBµV/m) = Reading(dBµV/m) + Factor (dB) .

2. Factor (dB) = Antenna Factor (dB/m) + Cable loss (dB) - Pre Amplifier gain (dB).

Adapter: SOY-2400250-332-A

Horizontal

Test Graph

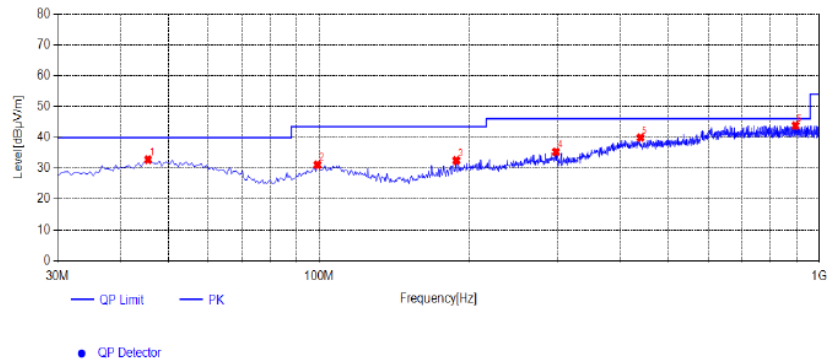

Suspected List											
NO.	Frequency [MHz]	Reading [dBµV/m]	Factor [dB]	Result [dBµV/m]	Limit [dBµV/m]	Margin [dB]	Height [cm]	Angle [°]	Detector	Polarity	Remark
1	45.52	44.15	-11.36	32.79	40.00	7.21	100	12	PK	Horizontal	PASS
2	99.355	43.66	-12.55	31.11	43.50	12.39	100	358	PK	Horizontal	PASS
3	188.11	45.85	-13.33	32.52	43.50	10.98	100	284	PK	Horizontal	PASS
4	297.72	44.82	-9.58	35.24	46.00	10.76	100	85	PK	Horizontal	PASS
5	439.34	43.37	-3.43	39.94	46.00	6.06	100	357	PK	Horizontal	PASS
6	896.695	41.22	2.61	43.83	46.00	2.17	100	165	PK	Horizontal	PASS

Note: 1. Result (dBµV/m) = Reading(dBµV/m) + Factor (dB) .

2. Factor (dB) = Antenna Factor (dB/m) + Cable loss (dB) - Pre Amplifier gain (dB).

Vertical

Test Graph

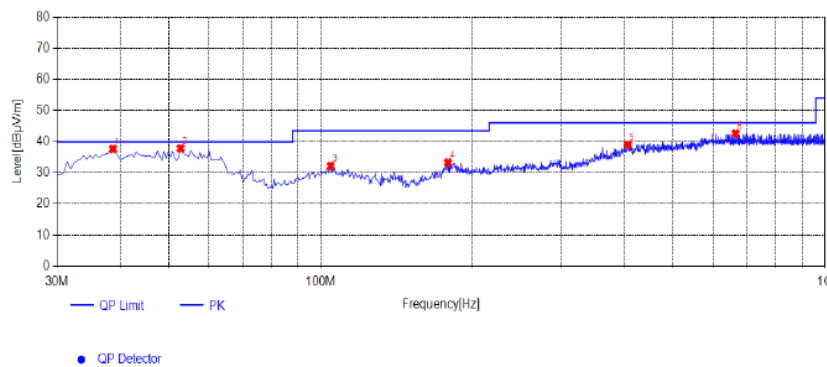

Suspected List											
NO.	Frequency [MHz]	Reading [dBµV/m]	Factor [dB]	Result [dBµV/m]	Limit [dBµV/m]	Margin [dB]	Height [cm]	Angle [°]	Detector	Polarity	Remark
1	38.73	50.64	-13.07	37.57	40.00	2.43	100	22	PK	Vertical	PASS
2	52.795	48.96	-11.20	37.76	40.00	2.24	100	19	PK	Vertical	PASS
3	104.69	44.34	-12.19	32.15	43.50	11.35	100	317	PK	Vertical	PASS
4	178.895	47.81	-14.61	33.20	43.50	10.30	100	42	PK	Vertical	PASS
5	406.845	42.42	-3.42	39.00	46.00	7.00	100	68	PK	Vertical	PASS
6	665.35	43.26	-0.63	42.63	46.00	3.37	100	208	PK	Vertical	PASS

Note: 1. Result (dBµV/m) = Reading(dBµV/m) + Factor (dB) .

2. Factor (dB) = Antenna Factor (dB/m) + Cable loss (dB) - Pre Amplifier gain (dB).

Adapter: AD65CM249250A

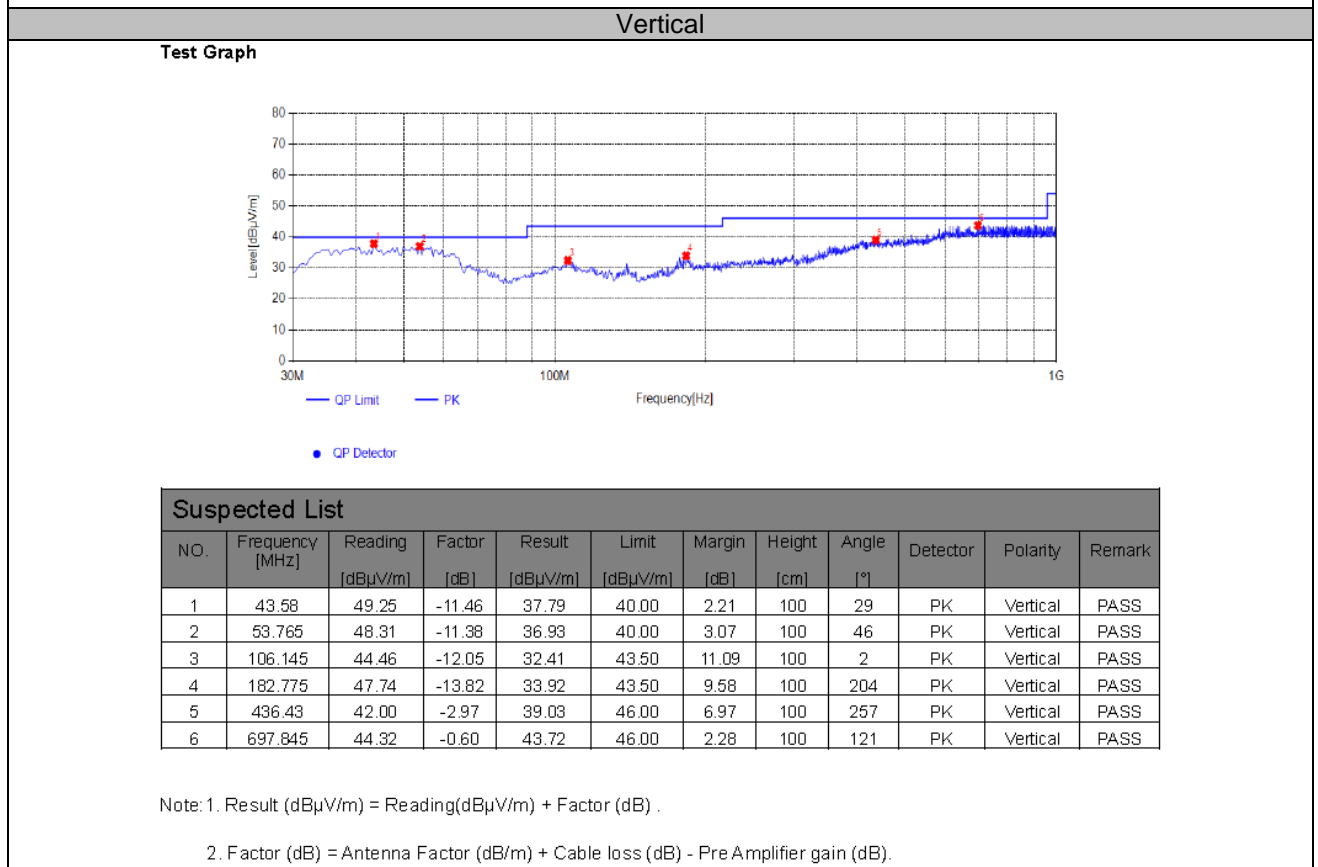
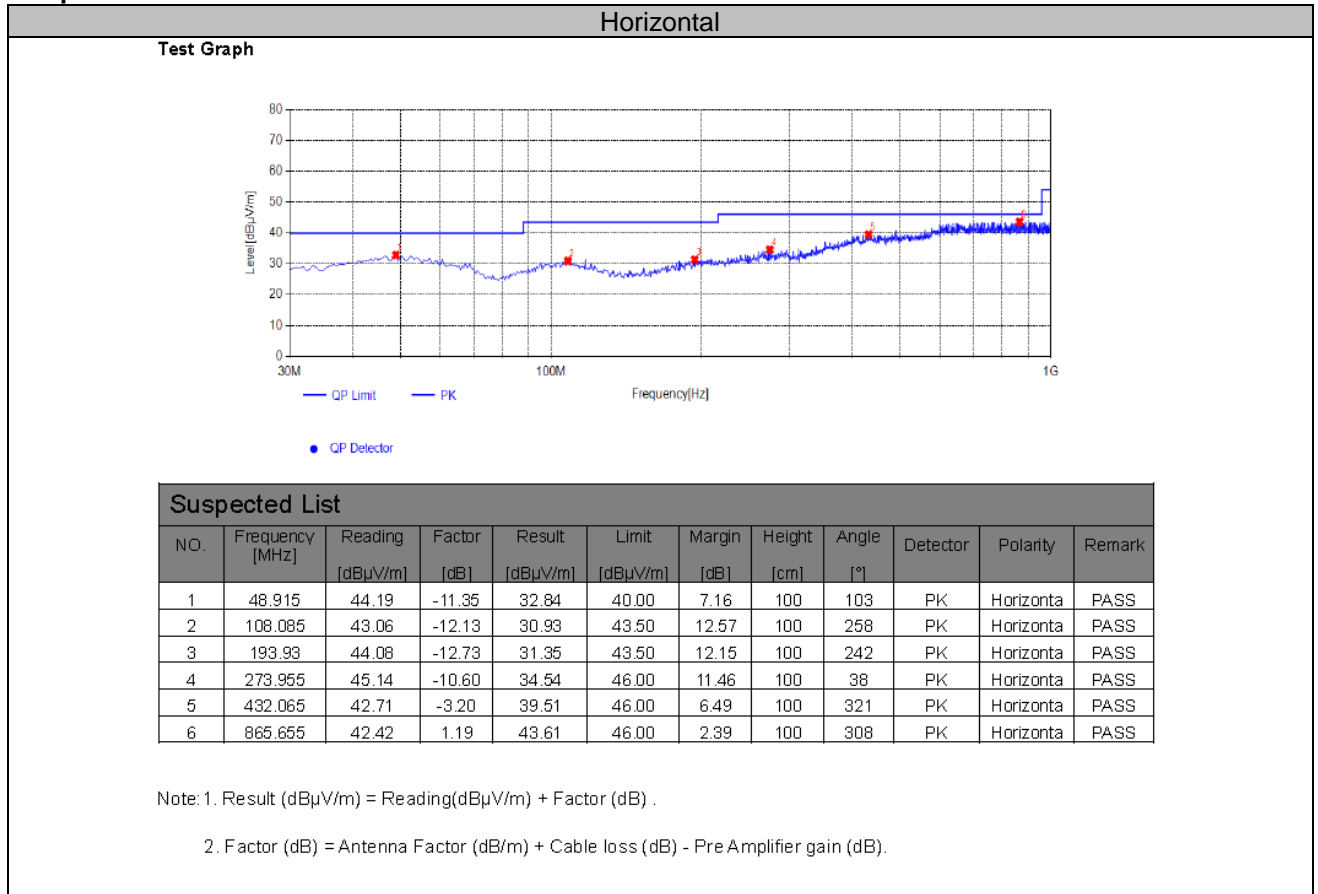

Adapter: ADS-65HI-19A-1 24060E

Horizontal

Test Graph

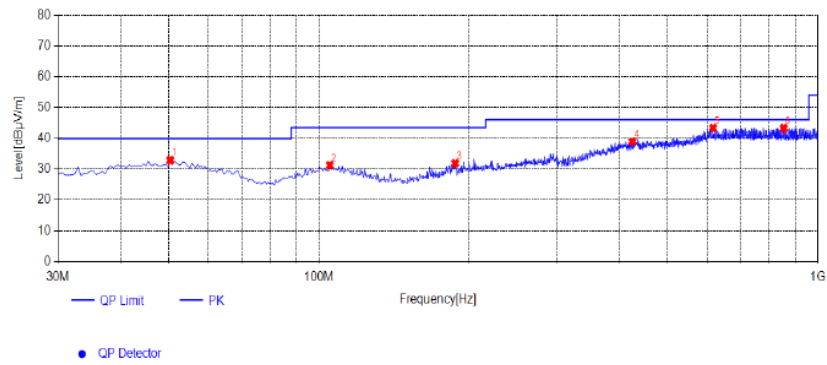

Suspected List

NO.	Frequency [MHz]	Reading [dBµV/m]	Factor [dB]	Result [dBµV/m]	Limit [dBµV/m]	Margin [dB]	Height [cm]	Angle [°]	Detector	Polarity	Remark
1	50.37	43.99	-11.11	32.88	40.00	7.12	100	327	PK	Horizontal	PASS
2	105.175	43.43	-12.16	31.27	43.50	12.23	100	290	PK	Horizontal	PASS
3	187.625	45.29	-13.37	31.92	43.50	11.58	100	261	PK	Horizontal	PASS
4	425.275	42.55	-3.59	38.96	46.00	7.04	100	182	PK	Horizontal	PASS
5	616.85	44.59	-1.25	43.34	46.00	2.66	100	294	PK	Horizontal	PASS
6	854.5	41.97	1.30	43.27	46.00	2.73	100	198	PK	Horizontal	PASS

Note: 1. Result (dBµV/m) = Reading(dBµV/m) + Factor (dB) .

2. Factor (dB) = Antenna Factor (dB/m) + Cable loss (dB) - Pre Amplifier gain (dB).

Vertical

Test Graph

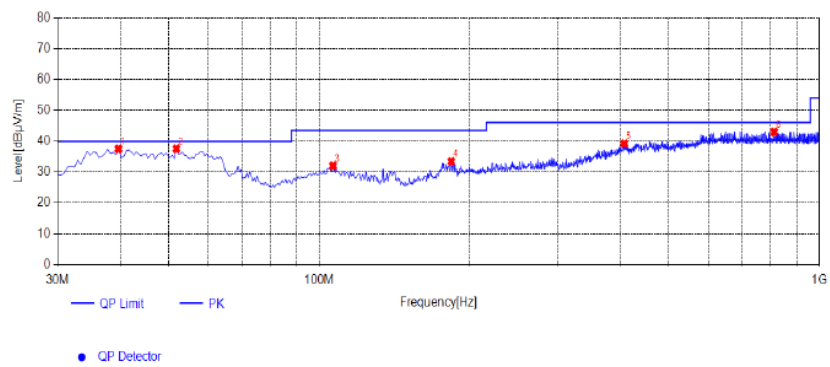

Suspected List

NO.	Frequency [MHz]	Reading [dBµV/m]	Factor [dB]	Result [dBµV/m]	Limit [dBµV/m]	Margin [dB]	Height [cm]	Angle [°]	Detector	Polarity	Remark
1	39.7	50.10	-12.66	37.44	40.00	2.56	100	12	PK	Vertical	PASS
2	51.825	48.81	-11.33	37.48	40.00	2.52	100	1	PK	Vertical	PASS
3	106.63	43.90	-11.88	32.02	43.50	11.48	100	254	PK	Vertical	PASS
4	183.745	47.05	-13.65	33.40	43.50	10.10	100	217	PK	Vertical	PASS
5	407.33	42.62	-3.40	39.22	46.00	6.78	100	35	PK	Vertical	PASS
6	812.305	41.10	1.90	43.00	46.00	3.00	100	3	PK	Vertical	PASS

Note: 1. Result (dBµV/m) = Reading(dBµV/m) + Factor (dB) .

2. Factor (dB) = Antenna Factor (dB/m) + Cable loss (dB) - Pre Amplifier gain (dB).

For 1GHz to 25GHz

IEEE 802.11n HT20_MIMO(Worst Case)

Channel 1 / 2412 MHz

Freq. MHz	Reading dBuV	Ant. Fac. dB/m	Pre. Fac. dB	Cab. Loss dB	Measured dBuV/m	Limit dBuV/m	Margin dB	Remark	Pol.
4824.00	49.98	32.44	30.25	7.95	60.12	74.00	-13.88	Peak	Horizontal
4824.00	35.43	32.44	30.25	7.95	45.57	54.00	-8.43	Average	Horizontal
4824.00	53.86	32.44	30.25	7.95	64.00	74.00	-10.00	Peak	Vertical
4824.00	35.28	32.44	30.25	7.95	45.42	54.00	-8.58	Average	Vertical

Channel 6 / 2437 MHz

Freq. MHz	Reading dBuV	Ant. Fac. dB/m	Pre. Fac. dB	Cab. Loss dB	Measured dBuV/m	Limit dBuV/m	Margin dB	Remark	Pol.
4874.00	49.17	32.52	30.31	8.12	59.50	74.00	-14.50	Peak	Horizontal
4874.00	37.50	32.52	30.31	8.12	47.83	54.00	-6.17	Average	Horizontal
4874.00	52.45	32.52	30.31	8.12	62.78	74.00	-11.22	Peak	Vertical
4874.00	35.17	32.52	30.31	8.12	45.50	54.00	-8.50	Average	Vertical

Channel 11 / 2462 MHz

Freq. MHz	Reading dBuV	Ant. Fac. dB/m	Pre. Fac. dB	Cab. Loss dB	Measured dBuV/m	Limit dBuV/m	Margin dB	Remark	Pol.
4924.00	50.90	32.68	30.27	7.88	61.19	74.00	-12.81	Peak	Horizontal
4924.00	35.96	32.68	30.27	7.88	46.25	54.00	-7.75	Average	Horizontal
4924.00	50.27	32.68	30.27	7.88	60.56	74.00	-13.44	Peak	Vertical
4924.00	32.38	32.68	30.27	7.88	42.67	54.00	-11.33	Average	Vertical

IEEE 802.11ax HE20_MIMO(Worst Case)

Channel 1 / 2412 MHz

Freq. MHz	Reading dBuV	Ant. Fac. dB/m	Pre. Fac. dB	Cab. Loss dB	Measured dBuV/m	Limit dBuV/m	Margin dB	Remark	Pol.
4824.00	49.48	32.44	30.25	7.95	59.62	74.00	-14.38	Peak	Horizontal
4824.00	36.64	32.44	30.25	7.95	46.78	54.00	-7.22	Average	Horizontal
4824.00	53.54	32.44	30.25	7.95	63.68	74.00	-10.32	Peak	Vertical
4824.00	36.09	32.44	30.25	7.95	46.23	54.00	-7.77	Average	Vertical

Channel 6 / 2437 MHz

Freq. MHz	Reading dBuV	Ant. Fac. dB/m	Pre. Fac. dB	Cab. Loss dB	Measured dBuV/m	Limit dBuV/m	Margin dB	Remark	Pol.
4874.00	49.37	32.52	30.31	8.12	59.70	74.00	-14.30	Peak	Horizontal
4874.00	36.58	32.52	30.31	8.12	46.91	54.00	-7.09	Average	Horizontal
4874.00	52.01	32.52	30.31	8.12	62.34	74.00	-11.66	Peak	Vertical
4874.00	35.30	32.52	30.31	8.12	45.63	54.00	-8.37	Average	Vertical

Channel 11 / 2462 MHz

Freq. MHz	Reading dBuV	Ant. Fac. dB/m	Pre. Fac. dB	Cab. Loss dB	Measured dBuV/m	Limit dBuV/m	Margin dB	Remark	Pol.
4924.00	50.29	32.68	30.27	7.88	60.58	74.00	-13.42	Peak	Horizontal
4924.00	36.71	32.68	30.27	7.88	47.00	54.00	-7.00	Average	Horizontal
4924.00	49.03	32.68	30.27	7.88	59.32	74.00	-14.68	Peak	Vertical
4924.00	30.96	32.68	30.27	7.88	41.25	54.00	-12.75	Average	Vertical

REMARKS:

1. Emission level (dBuV/m) =Raw Value (dBuV)+Correction Factor (dB/m)
2. Correction Factor (dB/m) = Antenna Factor (dB/m)+Cable Factor (dB)-Pre-amplifier Factor
3. Margin value = Limit value- Emission level.
4. -- Mean the PK detector measured value is below average limit.
5. The other emission levels were very low against the limit.

NOTE: All the modes have been tested and recorded worst mode in the report(Version A_Adapter: CYSE65-240250).

4.3. Maximum Peak Output Power

TEST CONFIGURATION

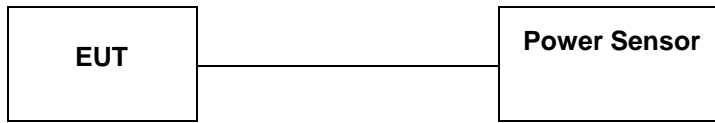

TEST PROCEDURE

According to KDB558074 D01 DTS Measurement Guidance Section 9.1 Maximum peak conducted output power,9.1.2. and Average conducted output power, 9.2.3.1.

The maximum peak conducted output power may be measured using a broadband peak RF power meter. The power meter shall have a video bandwidth that is greater than or equal to the DTS bandwidth and shall utilize a fast-responding diode detector.

The maximum Average conducted output power may be measured using a wideband RF power meter with a thermocouple derector or equivalent. The power meter shall have a video bandwidth that is greater than or equal to the DTS bandwidth and shall utilize a fast-responding diode detector.

LIMIT

The Maximum Peak Output Power Measurement is 30dBm.

TEST RESULTS

For reporting purpose only.

Antenna 0:

Please refer to Appendix C-ANT0-Appendix C.3.

For reporting purpose only.

Antenna 1:

Please refer to Appendix C-ANT1-Appendix C.3.

For reporting purpose only.

MIMO*2

Type	Channel	Peak Output power ANT0 (dBm)	Peak Output power ANT1 (dBm)	Peak Output power Total (dBm)	Limit (dBm)	Result
802.11n (HT20)	01	22.90	18.57	24.26	30.00	Pass
	06	23.19	18.79	24.54		
	11	23.47	19.01	24.80		
802.11ax (HE20)	01	21.20	16.50	22.47	30.00	Pass
	06	21.45	16.75	22.72		
	11	23.00	20.63	24.99		

Remark:

The Directional Gain= Gain of individual transmit antennas (dBi) + Array gain;

Array gain = 10 log (Nant), where Nant is the number of transmit antennas

Directional Gain=5.01 dBi

MIMO Limit (dBm)= Limit (dBm)-(Directional Gain-6dBi)

4.4. Power Spectral Density

TEST CONFIGURATION

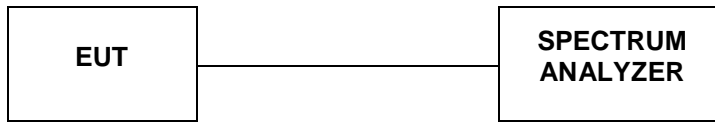

TEST PROCEDURE

According to KDB 558074 D01 Method PKPSD (peak PSD) This procedure shall be used if maximum peak conducted output power was used to demonstrate compliance, and is optional if the maximum conducted (average) output power was used to demonstrate compliance.

1. Set analyzer center frequency to DTS channel center frequency.
2. Set the span to 1.5 times the DTS bandwidth.
3. Set the RBW to: $3 \text{ kHz} \leq \text{RBW} \leq 100 \text{ kHz}$.
4. Set the VBW $\geq 3 \text{ RBW}$.
5. Detector = peak.
6. Sweep time = auto couple.
7. Trace mode = max hold.
8. Allow trace to fully stabilize.
9. Use the peak marker function to determine the maximum amplitude level within the RBW.
10. If measured value exceeds limit, reduce RBW (no less than 3 kHz) and repeat.

LIMIT

For digitally modulated systems, the power spectral density conducted from the intentional radiator to the antenna shall not be greater than 8 dBm in any 3 kHz band during any time interval of continuous transmission.

TEST RESULTS

For reporting purpose only.

Antenna 0:

Please refer to Appendix C-ANT0-Appendix C.4.

For reporting purpose only.

Antenna 1:

Please refer to Appendix C-ANT1-Appendix C.4.

For reporting purpose only.

MIMO*2

Type	Channel	Power Spectral Density ANT0 (dBm/3KHz)	Power Spectral Density ANT1 (dBm/3KHz)	Power Spectral Density Total (dBm/3KHz)	Limit (dBm/3KHz)	Result
802.11n(HT20)	01	-9.74	-14.29	-8.43	8.00	Pass
	06	-9.32	-13.59	-7.94		
	11	-9.38	-13.84	-8.05		
802.11ax(HE20)	01	-11.43	-16.61	-10.28	8.00	Pass
	06	-11.46	-15.64	-10.06		
	11	-9.65	-10.86	-7.20		

Remark:

The Directional Gain= Gain of individual transmit antennas (dBi) + Array gain;

Array gain = $10 \log(\text{Nant})$, where Nant is the number of transmit antennas

Directional Gain=5.01 dBi

MIMO Limit (dBm)= Limit (dBm)-(Directional Gain-6dBi)

4.5. 99% and 6dB Bandwidth

TEST CONFIGURATION

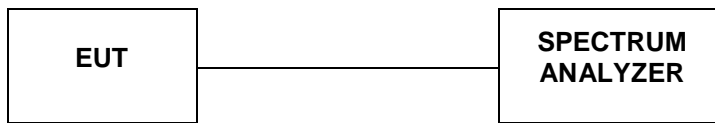

TEST PROCEDURE

The transmitter output was connected to the spectrum analyzer through an attenuator. The bandwidth of the fundamental frequency was measured by spectrum analyzer with RBW=100 KHz and VBW=300KHz. The 6dB bandwidth is defined as the total spectrum the power of which is higher than peak power minus 6dB. According to KDB558074 D01 for one of the following procedures may be used to determine the modulated DTS device signal bandwidth.

1. Set RBW = 100 kHz.
2. Set the video bandwidth (VBW) ≥ 3 RBW.
3. Detector = Peak.
4. Trace mode = max hold.
5. Sweep = auto couple.
6. Allow the trace to stabilize.
7. Measure the maximum width of the emission that is constrained by the frequencies associated with the two outermost amplitude points (upper and lower frequencies) that are attenuated by 6 dB relative to the maximum level measured in the fundamental emission.

LIMIT

For digital modulation systems, the minimum 6 dB bandwidth shall be at least 500 kHz

TEST RESULTS

For reporting purpose only.

6dB Bandwidth

Antenna 0:

Please refer to Appendix C-ANT0-C.1.

Antenna 1:

Please refer to Appendix C-ANT1-C.1.

99% Bandwidth

Antenna 0:

Please refer to Appendix C-ANT0-C.2.

Antenna 1:

Please refer to Appendix C-ANT1-C.2.

4.6. Conducted Spurious Emissions and Band Edge Compliance of RF Emission

TEST REQUIREMENT

In any 100 kHz bandwidth outside the frequency band in which the spread spectrum or digitally modulated intentional radiator is operating, the radio frequency power that is produced by the intentional radiator shall be at least 20 dB below that in the 100 kHz bandwidth within the band that contains the highest level of the desired power, based on either an RF conducted or a radiated measurement, provided the transmitter demonstrates compliance with the peak conducted power limits. If the transmitter complies with the conducted power limits based on the use of RMS averaging over a time interval, as permitted under paragraph (b)(3) of this section, the attenuation required under this paragraph shall be 30 dB instead of 20 dB. Attenuation below the general limits specified in §15.209(a) is not required. In addition, radiated emissions which fall in the restricted bands, as defined in §15.205(a), must also comply with the radiated emission limits specified in §15.209(a) (see §15.205(c)).

TEST PROCEDURE

According to KDB 558074 D01 for Antenna-port conducted measurement. Antenna-port conducted measurements may also be used as an alternative to radiated measurements for demonstrating compliance in the restricted frequency bands. If conducted measurements are performed, then proper impedance matching must be ensured and an additional radiated test for cabinet/case spurious emissions is required.

1. Check the calibration of the measuring instrument using either an internal calibrator or a known signal from an external generator.
2. Remove the antenna from the EUT and then connect to a low loss RF cable from the antenna port to a EMI test receiver, then turn on the EUT and make it operate in transmitting mode. Then set it to Low Channel and High Channel within its operating range, and make sure the instrument is operated in its linear range.
3. Set both RBW and VBW of spectrum analyzer to 100 kHz with a convenient frequency span including 100kHz bandwidth from band edge, for Radiated emissions restricted band RBW=1MHz, VBW=3MHz for peak detector and RBW=1MHz, VBW=10Hz for average detector.
4. Measure the highest amplitude appearing on spectral display and set it as a reference level. Plot the graph with marking the highest point and edge frequency.
5. Repeat above procedures until all measured frequencies were complete.
6. Measure the conducted output power (in dBm) using the detector specified by the appropriate regulatory agency (see 12.2.2, 12.2.3, and 12.2.4 for guidance regarding measurement procedures for determining quasi-peak, peak, and average conducted output power, respectively).
7. Add the maximum transmit antenna gain (in dBi) to the measured output power level to determine the EIRP level (see 12.2.5 for guidance on determining the applicable antenna gain)
8. Add the appropriate maximum ground reflection factor to the EIRP level (6 dB for frequencies \leq 30 MHz, 4.7 dB for frequencies between 30 MHz and 1000 MHz, inclusive and 0 dB for frequencies $>$ 1000 MHz).
9. For devices with multiple antenna-ports, measure the power of each individual chain and sum the EIRP of all chains in linear terms (e.g., Watts, mW).
10. Convert the resultant EIRP level to an equivalent electric field strength using the following relationship:

$$E = \text{EIRP} - 20\log D + 104.8$$

where:

E = electric field strength in dB μ V/m,

EIRP = equivalent isotropic radiated power in dBm

D = specified measurement distance in meters.

11. Since the out-of-band characteristics of the EUT transmit antenna will often be unknown, the use of a conservative antenna gain value is necessary. Thus, when determining the EIRP based on the measured conducted power, the upper bound on antenna gain for a device with a single RF output shall be selected as the maximum in-band gain of the antenna across all operating bands, or 2 dBi, whichever is greater. However, for devices that operate in multiple frequency bands while using the same transmit antenna, the highest gain of the antenna within the operating band nearest in frequency to the restricted band emission being measured may be used in lieu of the overall highest gain when the emission is at a frequency that is within 20 percent of the nearest band edge frequency, but in no case shall a value less than 2 dBi be used.
12. Compare the resultant electric field strength level to the applicable regulatory limit.
13. Perform radiated spurious emission test dures until all measured frequencies were complete.

LIMIT

Below -20dB of the highest emission level in operating band.

Radiated emissions which fall in the restricted bands, as defined in § 15.205(a), must also comply with the radiated emission limits specified in § 15.209(a).

TEST RESULTS

4.6.1 For Radiated Bandedge Measurement

Temperature	23.8°C	Humidity	53.7%
Test Engineer	Jenny Zeng	Configurations	IEEE 802.11b/g/n/ax

NOTE: All the modes have been tested and recorded worst mode in the report.

IEEE 802.11b_Antenna 0

Frequency(MHz):			2412			Polarity:			HORIZONTAL		
Frequency (MHz)	Emission Level (dBuV/m)		Limit (dBuV/m)	Margin (dB)	Antenna Height (m)	Table Angle (Degree)	Raw Value (dBuV)	Antenna Factor (dB/m)	Cable Factor (dB)	Pre-amplifier	Correction Factor (dB/m)
2390.00	46.65	PK	74.00	-27.35	1.50	99	51.96	27.49	3.32	36.12	-5.31
2390.00	34.17	AV	54.00	-19.83	1.50	99	39.48	27.49	3.32	36.12	-5.31
Frequency(MHz):			2412			Polarity:			VERTICAL		
Frequency (MHz)	Emission Level (dBuV/m)		Limit (dBuV/m)	Margin (dB)	Antenna Height (m)	Table Angle (Degree)	Raw Value (dBuV)	Antenna Factor (dB/m)	Cable Factor (dB)	Pre-amplifier	Correction Factor (dB/m)
2390.00	49.06	PK	74.00	-24.94	1.50	254	54.37	27.49	3.32	36.12	-5.31
2390.00	30.65	AV	54.00	-23.35	1.50	254	35.96	27.49	3.32	36.12	-5.31
Frequency(MHz):			2462			Polarity:			HORIZONTAL		
Frequency (MHz)	Emission Level (dBuV/m)		Limit (dBuV/m)	Margin (dB)	Antenna Height (m)	Table Angle (Degree)	Raw Value (dBuV)	Antenna Factor (dB/m)	Cable Factor (dB)	Pre-amplifier	Correction Factor (dB/m)
2483.50	45.47	PK	74.00	-28.53	1.50	196	51.19	27.45	3.38	36.55	-5.72
2483.50	34.49	AV	54.00	-19.51	1.50	196	40.21	27.45	3.38	36.55	-5.72
Frequency(MHz):			2462			Polarity:			VERTICAL		
Frequency (MHz)	Emission Level (dBuV/m)		Limit (dBuV/m)	Margin (dB)	Antenna Height (m)	Table Angle (Degree)	Raw Value (dBuV)	Antenna Factor (dB/m)	Cable Factor (dB)	Pre-amplifier	Correction Factor (dB/m)
2483.50	49.00	PK	74.00	-25.00	1.50	145	54.72	27.45	3.38	36.55	-5.72
2483.50	30.60	AV	54.00	-23.40	1.50	145	36.32	27.45	3.38	36.55	-5.72

IEEE 802.11g_Antenna 0

Frequency(MHz):			2412			Polarity:			HORIZONTAL		
Frequency (MHz)	Emission Level (dBuV/m)		Limit (dBuV/m)	Margin (dB)	Antenna Height (m)	Table Angle (Degree)	Raw Value (dBuV)	Antenna Factor (dB/m)	Cable Factor (dB)	Pre-amplifier	Correction Factor (dB/m)
2390.00	46.97	PK	74.00	-27.03	1.50	124	52.28	27.49	3.32	36.12	-5.31
2390.00	34.14	AV	54.00	-19.86	1.50	124	39.45	27.49	3.32	36.12	-5.31
Frequency(MHz):			2412			Polarity:			VERTICAL		
Frequency (MHz)	Emission Level (dBuV/m)		Limit (dBuV/m)	Margin (dB)	Antenna Height (m)	Table Angle (Degree)	Raw Value (dBuV)	Antenna Factor (dB/m)	Cable Factor (dB)	Pre-amplifier	Correction Factor (dB/m)
2390.00	49.97	PK	74.00	-24.03	1.50	76	55.28	27.49	3.32	36.12	-5.31
2390.00	29.63	AV	54.00	-24.37	1.50	76	34.94	27.49	3.32	36.12	-5.31
Frequency(MHz):			2462			Polarity:			HORIZONTAL		
Frequency (MHz)	Emission Level (dBuV/m)		Limit (dBuV/m)	Margin (dB)	Antenna Height (m)	Table Angle (Degree)	Raw Value (dBuV)	Antenna Factor (dB/m)	Cable Factor (dB)	Pre-amplifier	Correction Factor (dB/m)
2483.50	46.60	PK	74.00	-27.40	1.50	202	52.32	27.45	3.38	36.55	-5.72
2483.50	33.66	AV	54.00	-20.34	1.50	202	39.38	27.45	3.38	36.55	-5.72
Frequency(MHz):			2462			Polarity:			VERTICAL		
Frequency (MHz)	Emission Level (dBuV/m)		Limit (dBuV/m)	Margin (dB)	Antenna Height (m)	Table Angle (Degree)	Raw Value (dBuV)	Antenna Factor (dB/m)	Cable Factor (dB)	Pre-amplifier	Correction Factor (dB/m)
2483.50	49.00	PK	74.00	-25.00	1.50	196	54.72	27.45	3.38	36.55	-5.72
2483.50	30.25	AV	54.00	-23.75	1.50	196	35.97	27.45	3.38	36.55	-5.72

IEEE 802.11n HT20_MIMO

Frequency(MHz):			2412			Polarity:			HORIZONTAL		
Frequency (MHz)	Emission Level (dBuV/m)		Limit (dBuV/m)	Margin (dB)	Antenna Height (m)	Table Angle (Degree)	Raw Value (dBuV)	Antenna Factor (dB/m)	Cable Factor (dB)	Pre-amplifier	Correction Factor (dB/m)
2390.00	46.17	PK	74.00	-27.83	1.50	104	51.48	27.49	3.32	36.12	-5.31
2390.00	35.13	AV	54.00	-18.87	1.50	104	40.44	27.49	3.32	36.12	-5.31
Frequency(MHz):			2412			Polarity:			VERTICAL		
Frequency (MHz)	Emission Level (dBuV/m)		Limit (dBuV/m)	Margin (dB)	Antenna Height (m)	Table Angle (Degree)	Raw Value (dBuV)	Antenna Factor (dB/m)	Cable Factor (dB)	Pre-amplifier	Correction Factor (dB/m)
2390.00	49.54	PK	74.00	-24.46	1.50	218	54.85	27.49	3.32	36.12	-5.31
2390.00	30.02	AV	54.00	-23.98	1.50	218	35.33	27.49	3.32	36.12	-5.31
Frequency(MHz):			2462			Polarity:			HORIZONTAL		
Frequency (MHz)	Emission Level (dBuV/m)		Limit (dBuV/m)	Margin (dB)	Antenna Height (m)	Table Angle (Degree)	Raw Value (dBuV)	Antenna Factor (dB/m)	Cable Factor (dB)	Pre-amplifier	Correction Factor (dB/m)
2483.50	46.58	PK	74.00	-27.42	1.50	349	52.30	27.45	3.38	36.55	-5.72
2483.50	34.34	AV	54.00	-19.66	1.50	349	40.06	27.45	3.38	36.55	-5.72
Frequency(MHz):			2462			Polarity:			VERTICAL		
Frequency (MHz)	Emission Level (dBuV/m)		Limit (dBuV/m)	Margin (dB)	Antenna Height (m)	Table Angle (Degree)	Raw Value (dBuV)	Antenna Factor (dB/m)	Cable Factor (dB)	Pre-amplifier	Correction Factor (dB/m)
2483.50	48.57	PK	74.00	-25.43	1.50	197	54.29	27.45	3.38	36.55	-5.72
2483.50	30.00	AV	54.00	-24.00	1.50	197	35.72	27.45	3.38	36.55	-5.72

IEEE 802.11ax HE20_MIMO

Frequency(MHz):			2412			Polarity:			HORIZONTAL		
Frequency (MHz)	Emission Level (dBuV/m)		Limit (dBuV/m)	Margin (dB)	Antenna Height (m)	Table Angle (Degree)	Raw Value (dBuV)	Antenna Factor (dB/m)	Cable Factor (dB)	Pre-amplifier	Correction Factor (dB/m)
2390.00	45.51	PK	74.00	-28.49	1.50	117	50.82	27.49	3.32	36.12	-5.31
2390.00	35.53	AV	54.00	-18.47	1.50	117	40.84	27.49	3.32	36.12	-5.31
Frequency(MHz):			2412			Polarity:			VERTICAL		
Frequency (MHz)	Emission Level (dBuV/m)		Limit (dBuV/m)	Margin (dB)	Antenna Height (m)	Table Angle (Degree)	Raw Value (dBuV)	Antenna Factor (dB/m)	Cable Factor (dB)	Pre-amplifier	Correction Factor (dB/m)
2390.00	50.14	PK	74.00	-23.86	1.50	261	55.45	27.49	3.32	36.12	-5.31
2390.00	30.86	AV	54.00	-23.14	1.50	261	36.17	27.49	3.32	36.12	-5.31
Frequency(MHz):			2462			Polarity:			HORIZONTAL		
Frequency (MHz)	Emission Level (dBuV/m)		Limit (dBuV/m)	Margin (dB)	Antenna Height (m)	Table Angle (Degree)	Raw Value (dBuV)	Antenna Factor (dB/m)	Cable Factor (dB)	Pre-amplifier	Correction Factor (dB/m)
2483.50	46.13	PK	74.00	-27.87	1.50	235	51.85	27.45	3.38	36.55	-5.72
2483.50	33.50	AV	54.00	-20.50	1.50	235	39.22	27.45	3.38	36.55	-5.72
Frequency(MHz):			2462			Polarity:			VERTICAL		
Frequency (MHz)	Emission Level (dBuV/m)		Limit (dBuV/m)	Margin (dB)	Antenna Height (m)	Table Angle (Degree)	Raw Value (dBuV)	Antenna Factor (dB/m)	Cable Factor (dB)	Pre-amplifier	Correction Factor (dB/m)
2483.50	48.64	PK	74.00	-25.36	1.50	188	54.36	27.45	3.38	36.55	-5.72
2483.50	29.29	AV	54.00	-24.71	1.50	188	35.01	27.45	3.38	36.55	-5.72

REMARKS:

1. Emission level (dBuV/m) =Raw Value (dBuV)+Correction Factor (dB/m)
2. Correction Factor (dB/m) = Antenna Factor (dB/m)+Cable Factor (dB)-Pre-amplifier Factor
3. Margin value = Limit value- Emission level.
4. -- Mean the PK detector measured value is below average limit.
5. The other emission levels were very low against the limit.

NOTE: All the modes have been tested and recorded worst mode in the report(Version A_Adapter: CYSE65-240250).

4.6.2 For Conducted Bandedge Measurement

For reporting purpose only.

Antenna 0:

Please refer to Appendix C-ANT0-Appendix C.5.

Antenna 1:

Please refer to Appendix C-ANT1-Appendix C.5.

4.6.3 For Conducted Spurious Emissions Measurement

For reporting purpose only.

Antenna 0:

Please refer to Appendix C-ANT0-Appendix C.6.

Antenna 1:

Please refer to Appendix C-ANT1-Appendix C.6.

4.7. Antenna Requirement

Standard Applicable

For intentional device, according to FCC 47 CFR Section 15.203, an intentional radiator shall be designed to ensure that no antenna other than that furnished by the responsible party shall be used with the device.

And according to FCC 47 CFR Section 15.247 (c), if transmitting antennas of directional gain greater than 6dBi are used, the power shall be reduced by the amount in dB that the directional gain of the antenna exceeds 6dBi.

Test Result

The antenna used for this product is Internal Antenna and that no antenna other than that furnished by the responsible party shall be used with the device, the maximum peak gain of the transmit antenna is only 2.00dBi.

Reference to the Test Report: **GTS20230704026-1-20**.

5. TEST SETUP PHOTOS OF THE EUT

Reference to the Test Report: GTS20230704026-1-20.

6. EXTERNAL AND INTERNAL PHOTOS OF THE EUT

Reference to the Test Report: GTS20230704026-1-20.

.....**End of Report**.....