

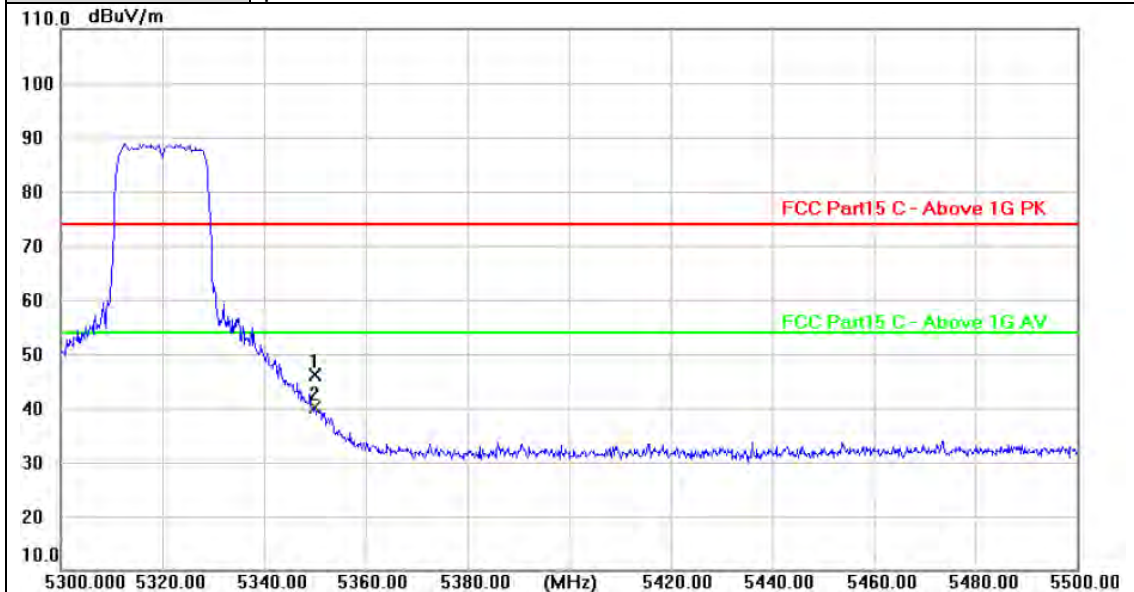

Ant. Pol.:	Vertical
Test Mode:	TX 802.11ac(VHT20) Mode 5320MHz (U-NII-2A)
Remark:	No report for the emission which more than 10 dB below the prescribed limit.



No.	Frequency (MHz)	Reading (dBuV)	Factor (dB/m)	Level (dBuV/m)	Limit (dBuV/m)	Margin (dB)	Detector
1	5350.000	42.75	3.43	46.18	74.00	-27.82	peak
2 *	5350.000	36.76	3.43	40.19	54.00	-13.81	AVG

Remarks:

1. Factor (dB/m) = Antenna Factor (dB/m)+Cable Factor (dB)-Pre-amplifier Factor
2. Margin value = Level -Limit value



Ant. Pol.:	Horizontal
Test Mode:	TX 802.11n(HT40) Mode 5190MHz (U-NII-1)
Remark:	No report for the emission which more than 10 dB below the prescribed limit.

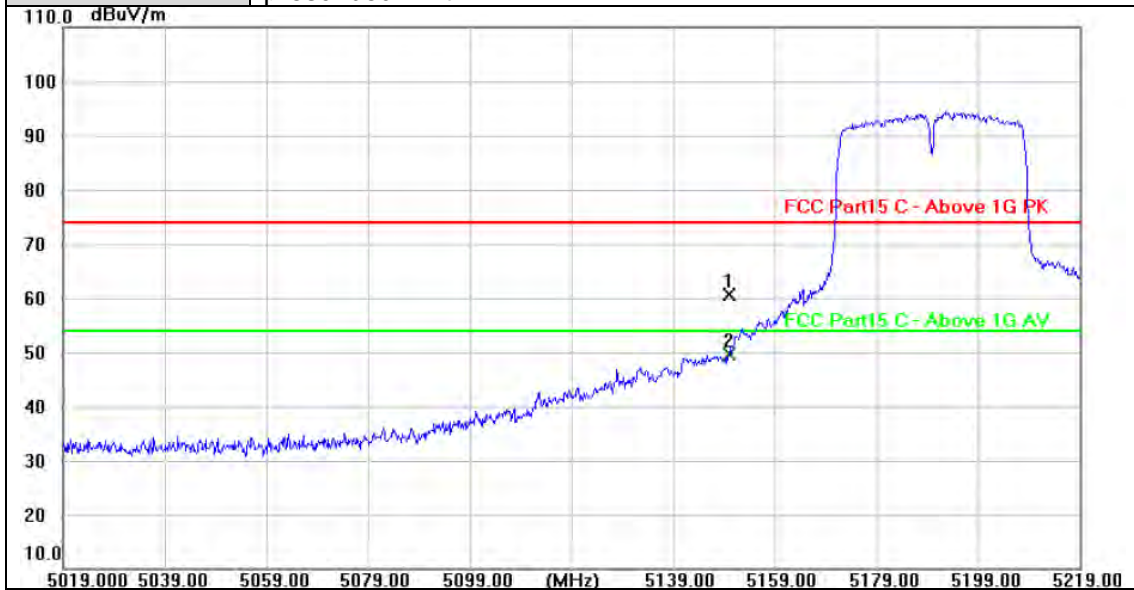

No.	Frequency (MHz)	Reading (dBuV)	Factor (dB/m)	Level (dBuV/m)	Limit (dBuV/m)	Margin (dB)	Detector
1	5150.000	57.60	2.93	60.53	74.00	-13.47	peak
2 *	5150.000	46.63	2.93	49.56	54.00	-4.44	AVG

Remarks:
 1. Factor (dB/m) = Antenna Factor (dB/m)+Cable Factor (dB)-Pre-amplifier Factor
 2. Margin value = Level -Limit value



Ant. Pol.:	Vertical
Test Mode:	TX 802.11n(HT40) Mode 5190MHz (U-NII-1)
Remark:	No report for the emission which more than 10 dB below the prescribed limit.

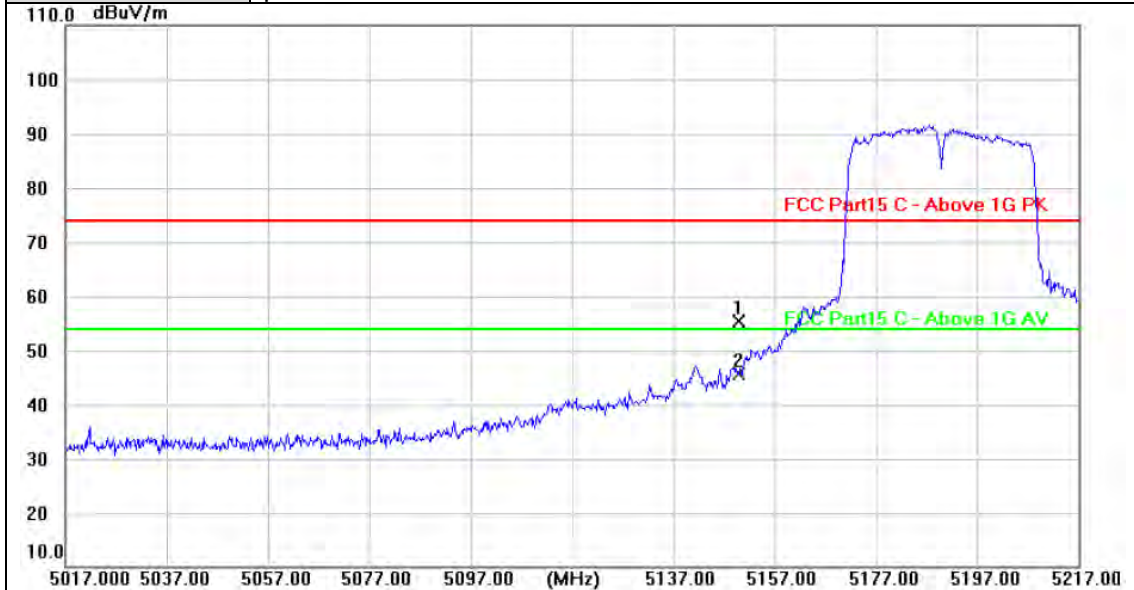

No.	Frequency (MHz)	Reading (dBuV)	Factor (dB/m)	Level (dBuV/m)	Limit (dBuV/m)	Margin (dB)	Detector
1	5150.000	52.47	2.93	55.40	74.00	-18.60	peak
2 *	5150.000	42.76	2.93	45.69	54.00	-8.31	AVG

Remarks:
 1. Factor (dB/m) = Antenna Factor (dB/m)+Cable Factor (dB)-Pre-amplifier Factor
 2. Margin value = Level -Limit value



Ant. Pol.:	Horizontal
Test Mode:	TX 802.11n(HT40) Mode 5310MHz (U-NII-2A)
Remark:	No report for the emission which more than 10 dB below the prescribed limit.

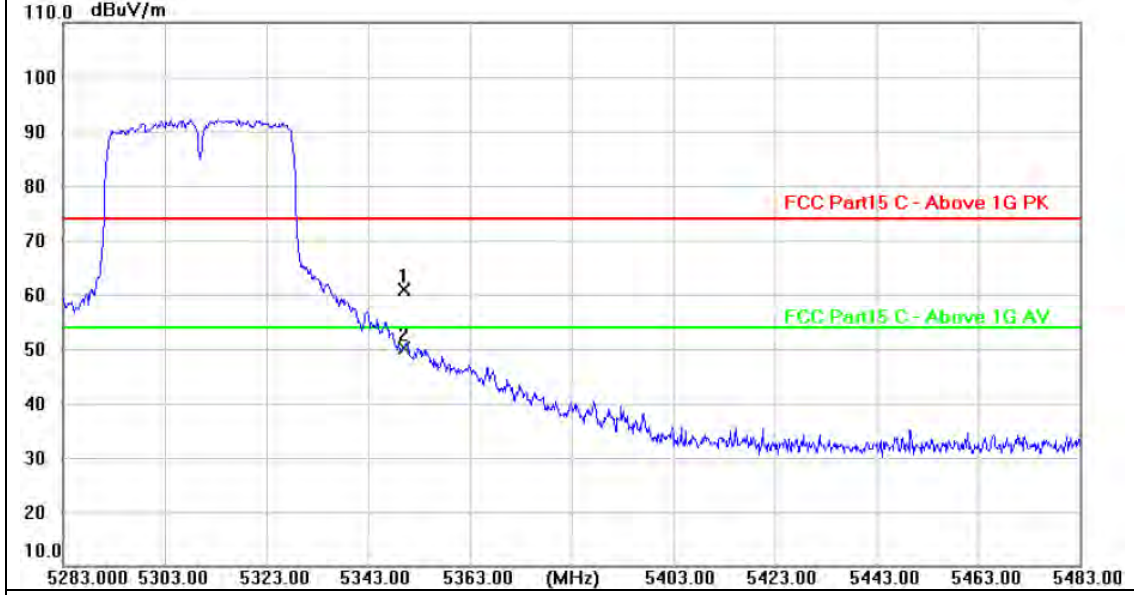

No.	Frequency (MHz)	Reading (dBuV)	Factor (dB/m)	Level (dBuV/m)	Limit (dBuV/m)	Margin (dB)	Detector
1	5350.000	57.45	3.43	60.88	74.00	-13.12	peak
2 *	5350.000	46.63	3.43	50.06	54.00	-3.94	AVG

Remarks:
 1. Factor (dB/m) = Antenna Factor (dB/m)+Cable Factor (dB)-Pre-amplifier Factor
 2. Margin value = Level -Limit value



Ant. Pol.:	Vertical
Test Mode:	TX 802.11n(HT40) Mode 5310MHz (U-NII-2A)
Remark:	No report for the emission which more than 10 dB below the prescribed limit.

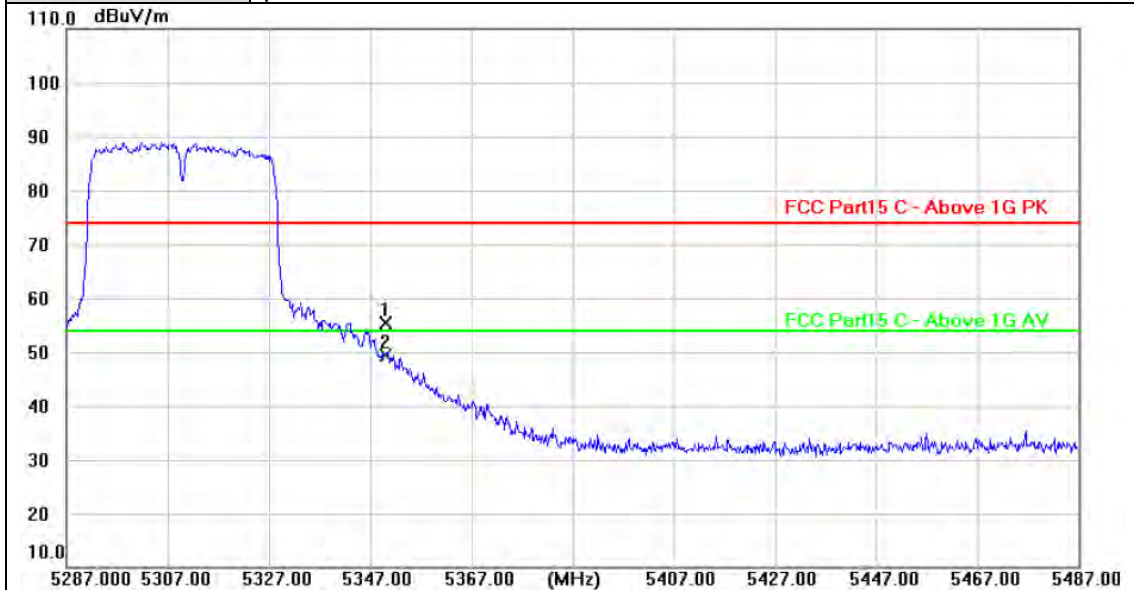

No.	Frequency (MHz)	Reading (dBuV)	Factor (dB/m)	Level (dBuV/m)	Limit (dBuV/m)	Margin (dB)	Detector
1	5350.000	51.99	3.43	55.42	74.00	-18.58	peak
2 *	5350.000	45.95	3.43	49.38	54.00	-4.62	AVG

Remarks:

1. Factor (dB/m) = Antenna Factor (dB/m)+Cable Factor (dB)-Pre-amplifier Factor
2. Margin value = Level -Limit value

Ant. Pol.:	Horizontal
Test Mode:	TX 802.11ac(VHT40) Mode 5190MHz (U-NII-1)
Remark:	No report for the emission which more than 10 dB below the prescribed limit.

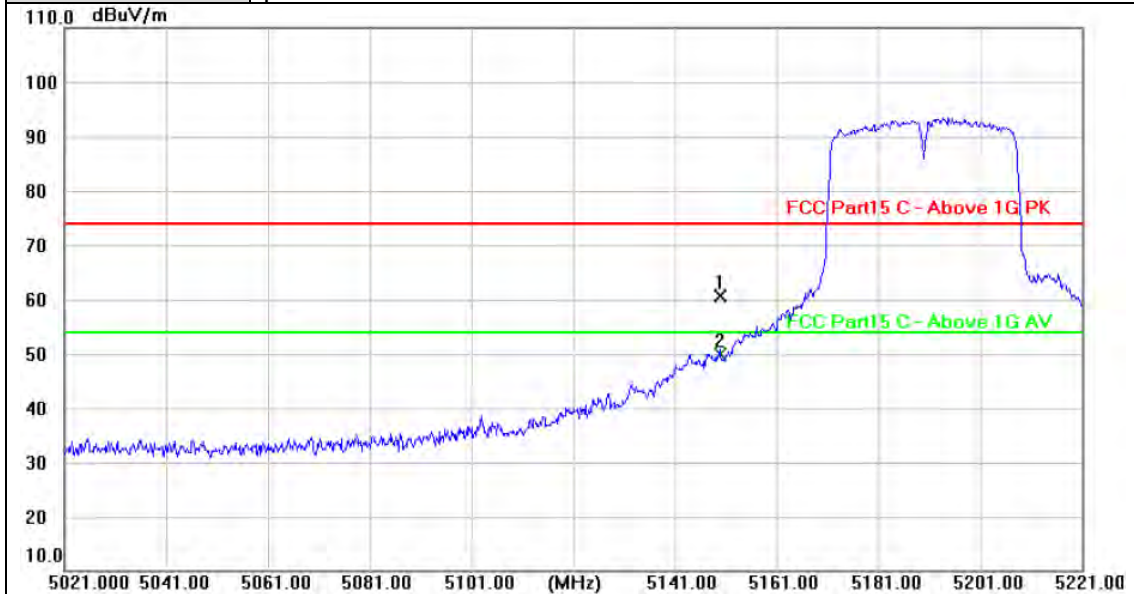

No.	Frequency (MHz)	Reading (dBuV)	Factor (dB/m)	Level (dBuV/m)	Limit (dBuV/m)	Margin (dB)	Detector
1	5150.000	57.73	2.93	60.66	74.00	-13.34	peak
2 *	5150.000	47.03	2.93	49.96	54.00	-4.04	AVG

Remarks:

- 1. Factor (dB/m) = Antenna Factor (dB/m)+Cable Factor (dB)-Pre-amplifier Factor
- 2. Margin value = Level -Limit value



Ant. Pol.:	Vertical
Test Mode:	TX 802.11ac(VHT40) Mode 5190MHz (U-NII-1)
Remark:	No report for the emission which more than 10 dB below the prescribed limit.

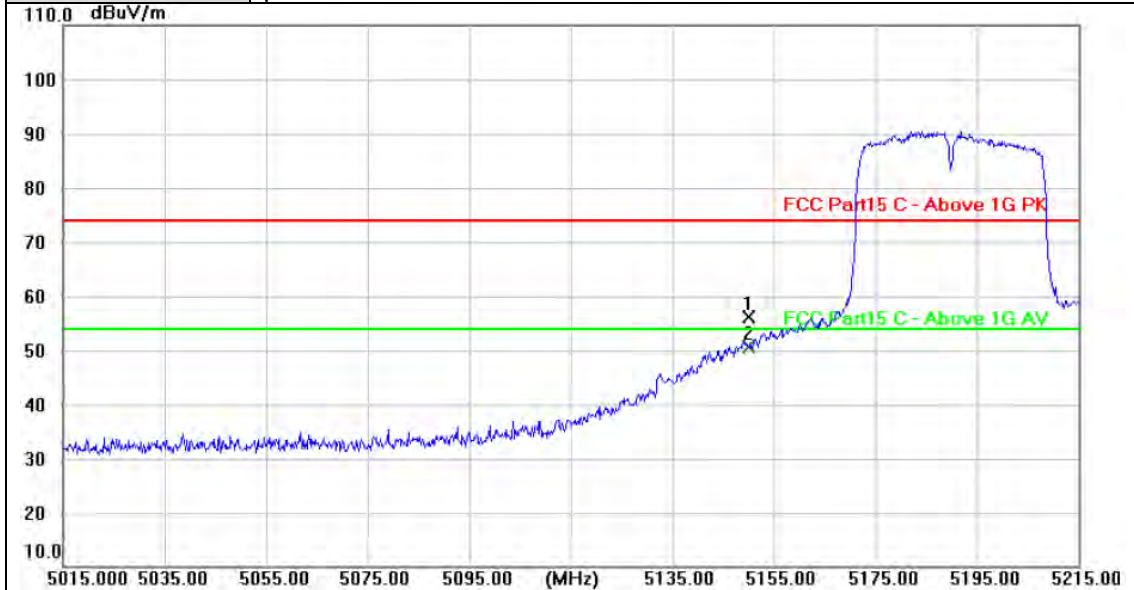

No.	Frequency (MHz)	Reading (dBuV)	Factor (dB/m)	Level (dBuV/m)	Limit (dBuV/m)	Margin (dB)	Detector
1	5150.000	53.14	2.93	56.07	74.00	-17.93	peak
2 *	5150.000	47.76	2.93	50.69	54.00	-3.31	AVG

Remarks:

1. Factor (dB/m) = Antenna Factor (dB/m)+Cable Factor (dB)-Pre-amplifier Factor
2. Margin value = Level -Limit value



Ant. Pol.:	Horizontal
Test Mode:	TX 802.11ac(VHT40) Mode 5310MHz (U-NII-2A)
Remark:	No report for the emission which more than 10 dB below the prescribed limit.

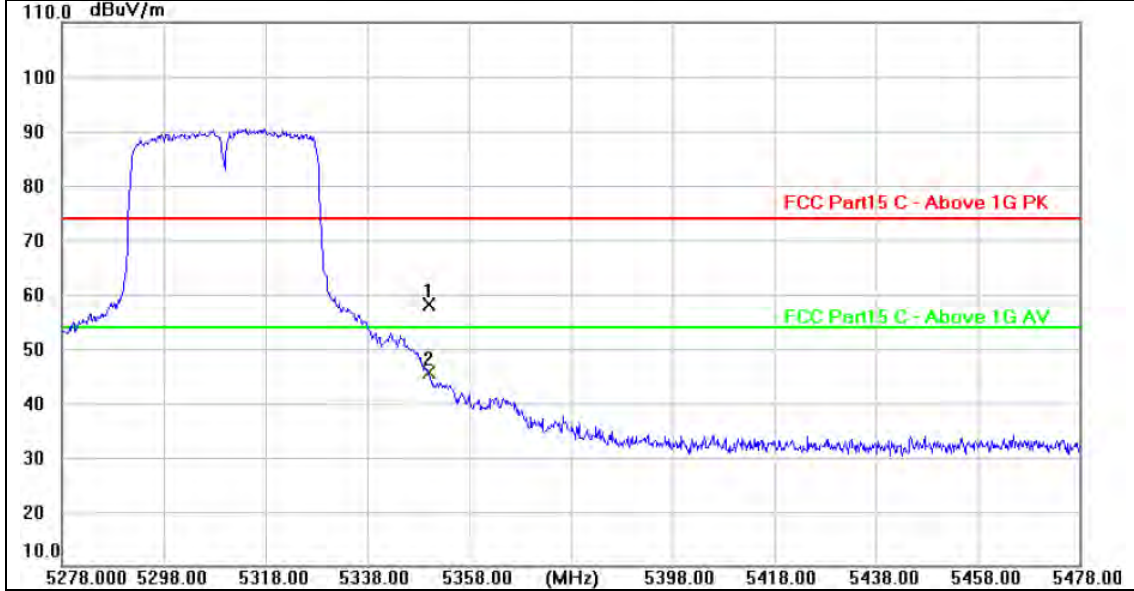

No.	Frequency (MHz)	Reading (dBuV)	Factor (dB/m)	Level (dBuV/m)	Limit (dBuV/m)	Margin (dB)	Detector
1	5350.000	54.60	3.43	58.03	74.00	-15.97	peak
2 *	5350.000	42.30	3.43	45.73	54.00	-8.27	AVG

Remarks:
 1. Factor (dB/m) = Antenna Factor (dB/m)+Cable Factor (dB)-Pre-amplifier Factor
 2. Margin value = Level -Limit value





Ant. Pol.:	Vertical
Test Mode:	TX 802.11ac(VHT40) Mode 5310MHz (U-NII-2A)
Remark:	No report for the emission which more than 10 dB below the prescribed limit.

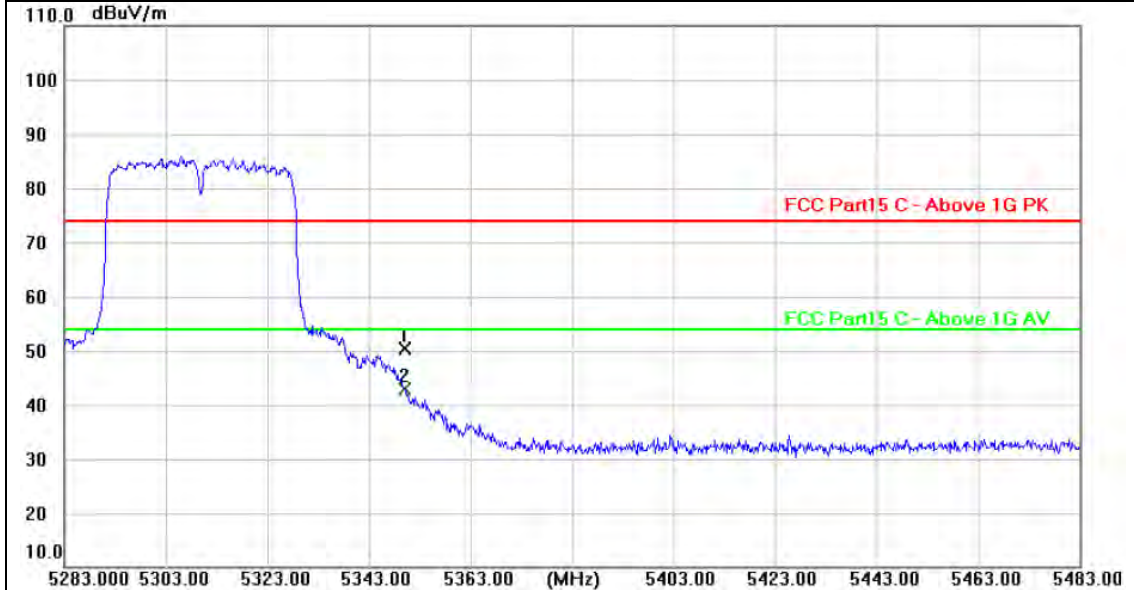

No.	Frequency (MHz)	Reading (dBuV)	Factor (dB/m)	Level (dBuV/m)	Limit (dBuV/m)	Margin (dB)	Detector
1	5350.000	46.90	3.43	50.33	74.00	-23.67	peak
2 *	5350.000	39.51	3.43	42.94	54.00	-11.06	AVG

Remarks:
 1. Factor (dB/m) = Antenna Factor (dB/m)+Cable Factor (dB)-Pre-amplifier Factor
 2. Margin value = Level -Limit value



Ant. Pol.:	Horizontal
Test Mode:	TX 802.11ac(VHT80) Mode 5210MHz (U-NII-1)
Remark:	No report for the emission which more than 10 dB below the prescribed limit.

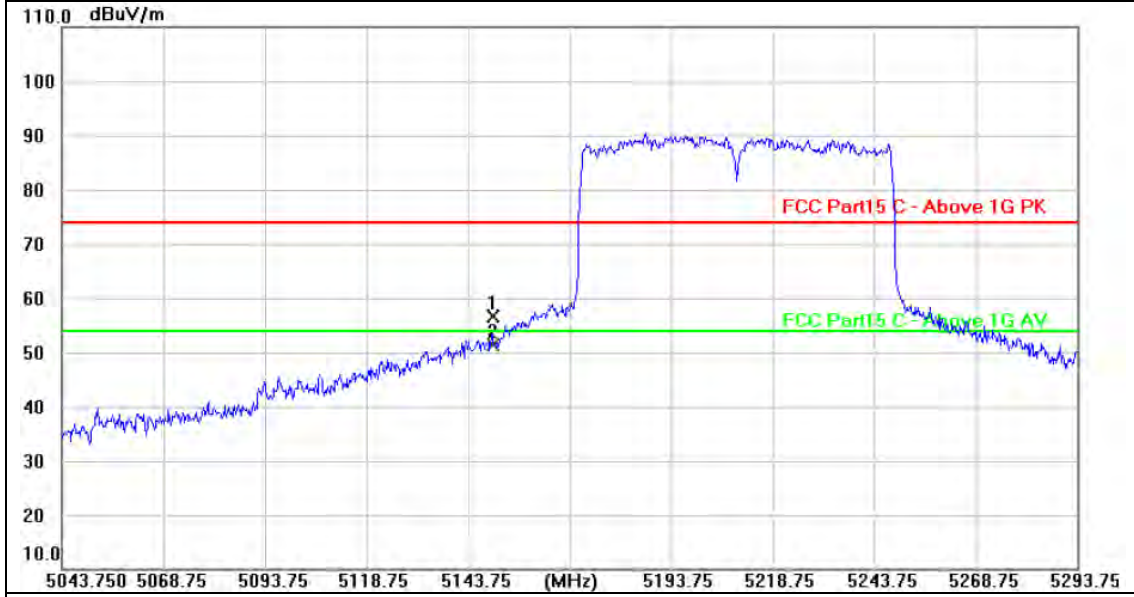

No.	Frequency (MHz)	Reading (dBuV)	Factor (dB/m)	Level (dBuV/m)	Limit (dBuV/m)	Margin (dB)	Detector
1	5150.000	53.76	2.93	56.69	74.00	-17.31	peak
2 *	5150.000	48.52	2.93	51.45	54.00	-2.55	AVG

Remarks:
 1. Factor (dB/m) = Antenna Factor (dB/m)+Cable Factor (dB)-Pre-amplifier Factor
 2. Margin value = Level -Limit value



Ant. Pol.:	Vertical
Test Mode:	TX 802.11ac(VHT80) Mode 5210MHz (U-NII-1)
Remark:	No report for the emission which more than 10 dB below the prescribed limit.

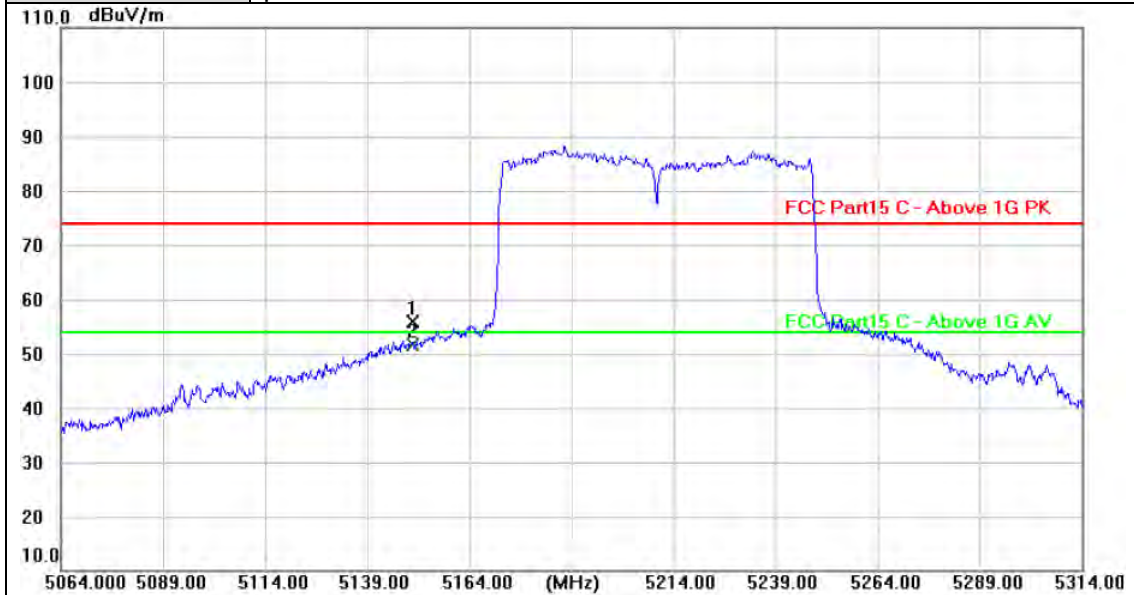

No.	Frequency (MHz)	Reading (dBuV)	Factor (dB/m)	Level (dBuV/m)	Limit (dBuV/m)	Margin (dB)	Detector
1	5150.000	52.94	2.93	55.87	74.00	-18.13	peak
2 *	5150.000	48.68	2.93	51.61	54.00	-2.39	AVG

Remarks:
 1. Factor (dB/m) = Antenna Factor (dB/m)+Cable Factor (dB)-Pre-amplifier Factor
 2. Margin value = Level -Limit value



Ant. Pol.:	Horizontal
Test Mode:	TX 802.11ac(VHT80) Mode 5290MHz (U-NII-2A)
Remark:	No report for the emission which more than 10 dB below the prescribed limit.

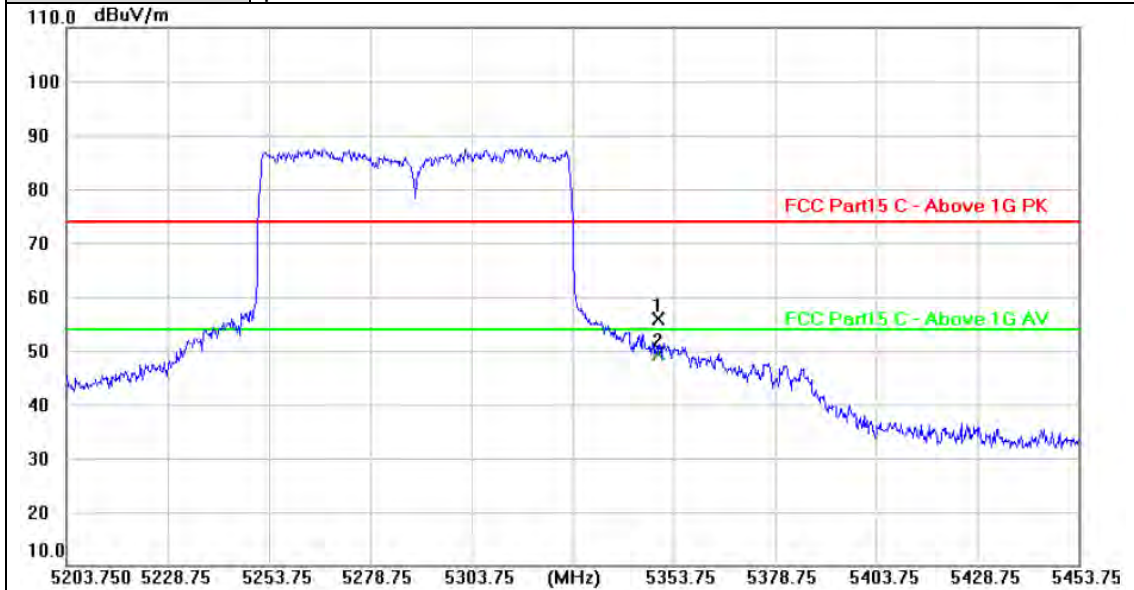

No.	Frequency (MHz)	Reading (dBuV)	Factor (dB/m)	Level (dBuV/m)	Limit (dBuV/m)	Margin (dB)	Detector
1	5350.000	52.55	3.43	55.98	74.00	-18.02	peak
2 *	5350.000	45.93	3.43	49.36	54.00	-4.64	AVG

Remarks:

- 1. Factor (dB/m) = Antenna Factor (dB/m)+Cable Factor (dB)-Pre-amplifier Factor
- 2. Margin value = Level -Limit value



Ant. Pol.:	Vertical
Test Mode:	TX 802.11ac(VHT80) Mode 5290MHz (U-NII-2A)
Remark:	No report for the emission which more than 10 dB below the prescribed limit.

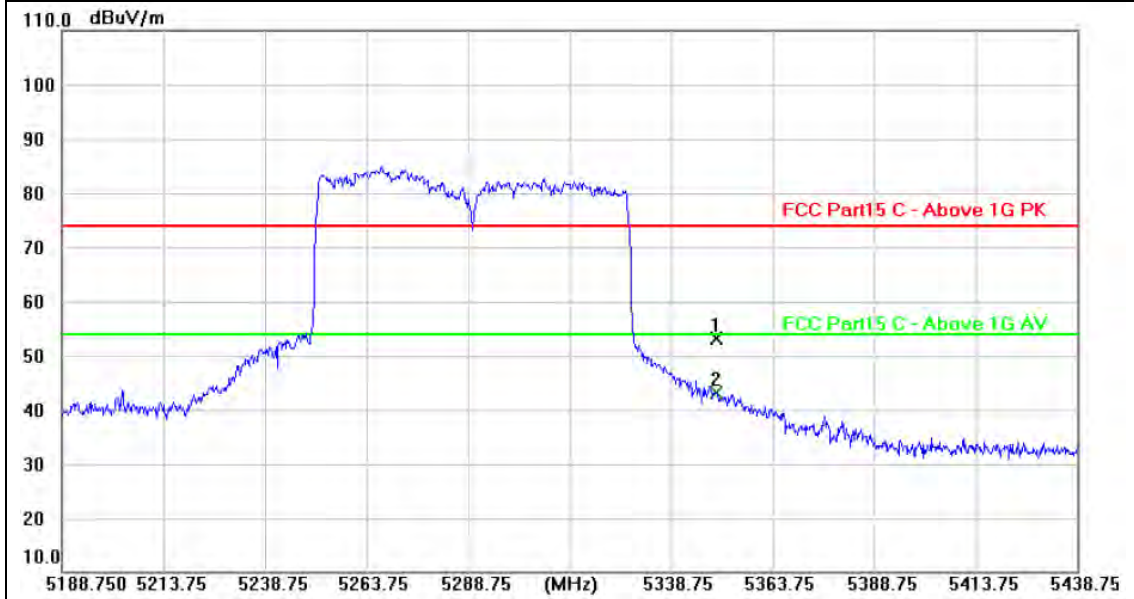

No.	Frequency (MHz)	Reading (dBuV)	Factor (dB/m)	Level (dBuV/m)	Limit (dBuV/m)	Margin (dB)	Detector
1	5350.000	49.82	3.43	53.25	74.00	-20.75	peak
2 *	5350.000	39.77	3.43	43.20	54.00	-10.80	AVG

Remarks:
 1. Factor (dB/m) = Antenna Factor (dB/m)+Cable Factor (dB)-Pre-amplifier Factor
 2. Margin value = Level -Limit value



Ant. Pol.:	Horizontal
Test Mode:	TX 802.11a Mode 5500MHz (U-NII-2C)
Remark:	No report for the emission which more than 10 dB below the prescribed limit.

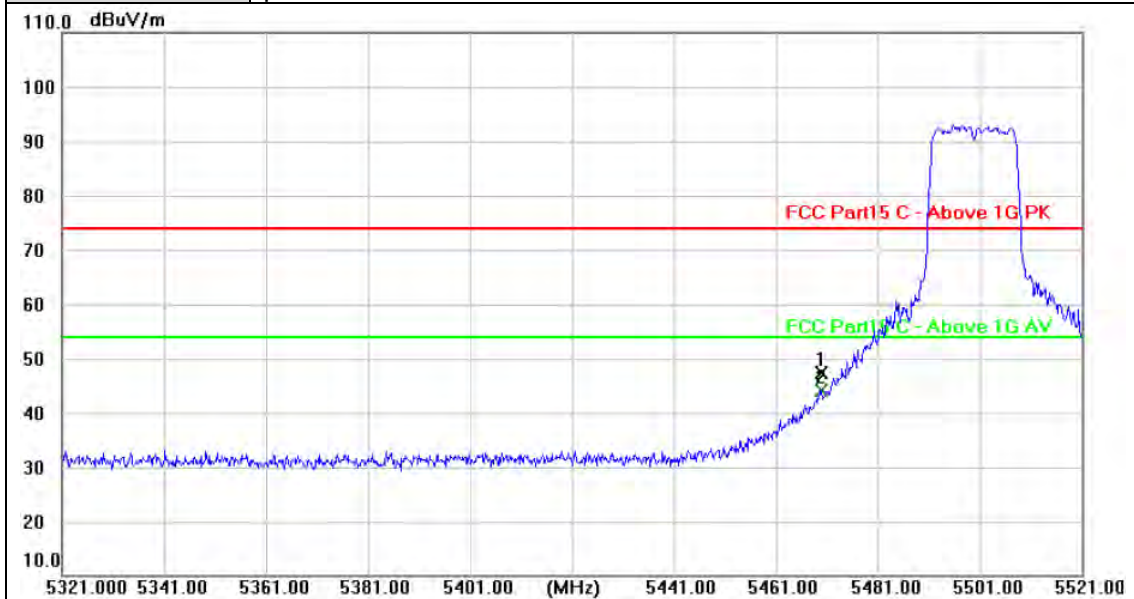

No.	Frequency (MHz)	Reading (dBuV)	Factor (dB/m)	Level (dBuV/m)	Limit (dBuV/m)	Margin (dB)	Detector
1	5470.000	43.73	3.73	47.46	74.00	-26.54	peak
2 *	5470.000	40.28	3.73	44.01	54.00	-9.99	AVG

Remarks:
 1. Factor (dB/m) = Antenna Factor (dB/m)+Cable Factor (dB)-Pre-amplifier Factor
 2. Margin value = Level -Limit value



Ant. Pol.:	Vertical
Test Mode:	TX 802.11a Mode 5500MHz (U-NII-2C)
Remark:	No report for the emission which more than 10 dB below the prescribed limit.

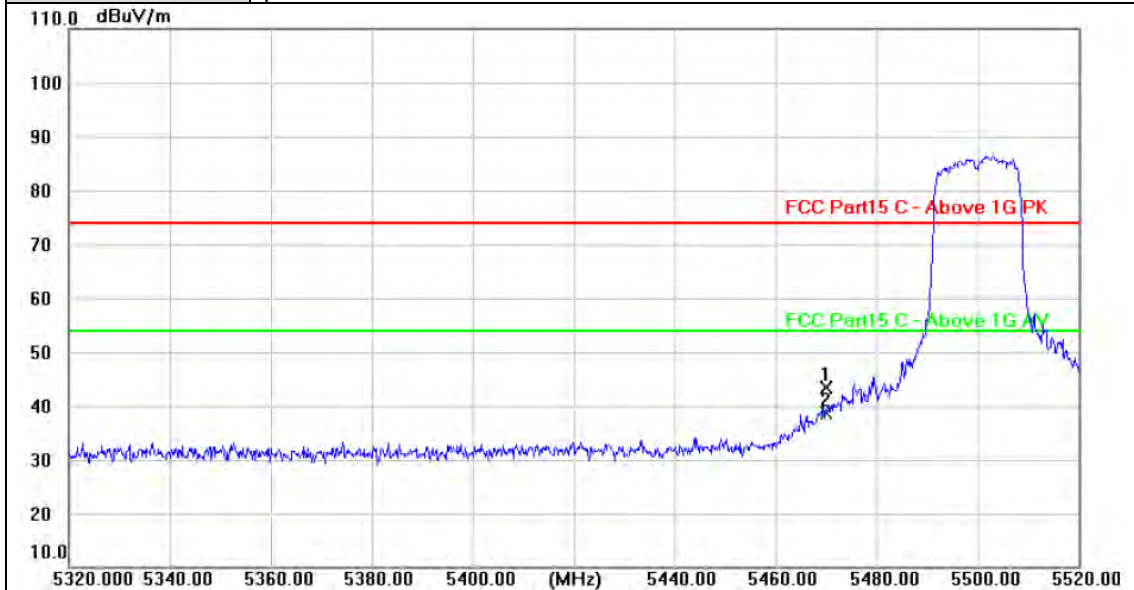

No.	Frequency (MHz)	Reading (dBuV)	Factor (dB/m)	Level (dBuV/m)	Limit (dBuV/m)	Margin (dB)	Detector
1	5470.000	39.60	3.73	43.33	74.00	-30.67	peak
2 *	5470.000	34.96	3.73	38.69	54.00	-15.31	AVG

Remarks:
 1. Factor (dB/m) = Antenna Factor (dB/m)+Cable Factor (dB)-Pre-amplifier Factor
 2. Margin value = Level -Limit value



Ant. Pol.:	Horizontal
Test Mode:	TX 802.11a Mode 5700MHz (U-NII-2C)
Remark:	No report for the emission which more than 10 dB below the prescribed limit.

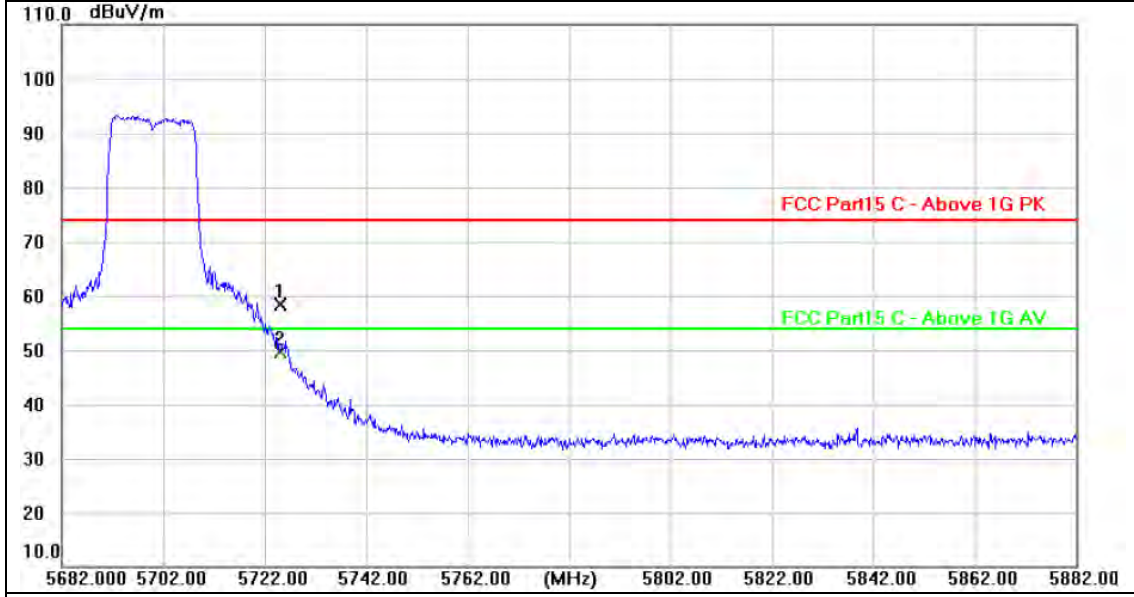

No.	Frequency (MHz)	Reading (dBuV)	Factor (dB/m)	Level (dBuV/m)	Limit (dBuV/m)	Margin (dB)	Detector
1	5725.000	53.94	4.54	58.48	74.00	-15.52	peak
2 *	5725.000	45.16	4.54	49.70	54.00	-4.30	AVG

Remarks:
 1. Factor (dB/m) = Antenna Factor (dB/m)+Cable Factor (dB)-Pre-amplifier Factor
 2. Margin value = Level -Limit value



Ant. Pol.:	Vertical
Test Mode:	TX 802.11a Mode 5700MHz (U-NII-2C)
Remark:	No report for the emission which more than 10 dB below the prescribed limit.

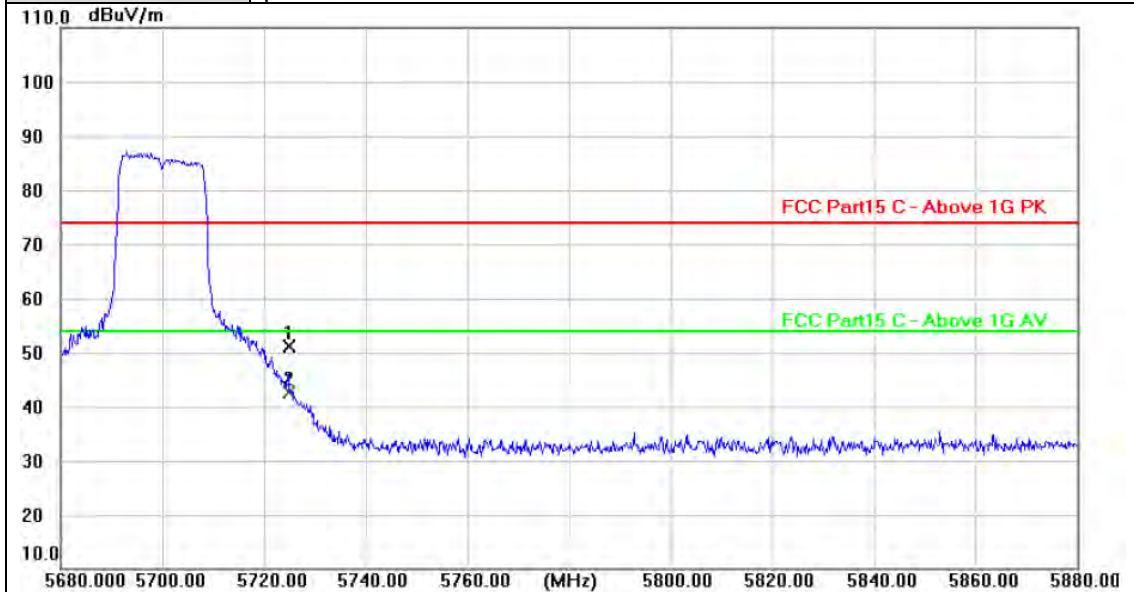

No.	Frequency (MHz)	Reading (dBuV)	Factor (dB/m)	Level (dBuV/m)	Limit (dBuV/m)	Margin (dB)	Detector
1	5725.000	46.69	4.54	51.23	74.00	-22.77	peak
2 *	5725.000	38.03	4.54	42.57	54.00	-11.43	AVG

Remarks:

- 1. Factor (dB/m) = Antenna Factor (dB/m) + Cable Factor (dB) - Pre-amplifier Factor
- 2. Margin value = Level - Limit value



Ant. Pol.:	Horizontal
Test Mode:	TX 802.11n(HT20) Mode 5500MHz (U-NII-2C)
Remark:	No report for the emission which more than 10 dB below the prescribed limit.

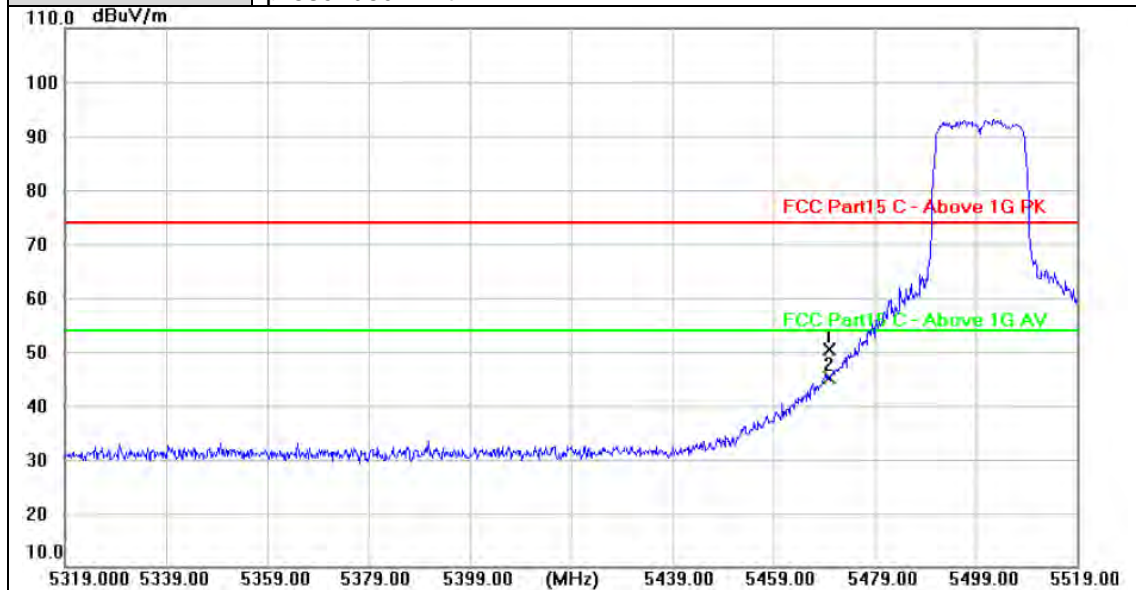

No.	Frequency (MHz)	Reading (dBuV)	Factor (dB/m)	Level (dBuV/m)	Limit (dBuV/m)	Margin (dB)	Detector
1	5470.000	46.60	3.73	50.33	74.00	-23.67	peak
2 *	5470.000	41.33	3.73	45.06	54.00	-8.94	AVG

Remarks:

- Factor (dB/m) = Antenna Factor (dB/m)+Cable Factor (dB)-Pre-amplifier Factor
- Margin value = Level -Limit value



Ant. Pol.:	Vertical
Test Mode:	TX 802.11n(HT20) Mode 5500MHz (U-NII-2C)
Remark:	No report for the emission which more than 10 dB below the prescribed limit.

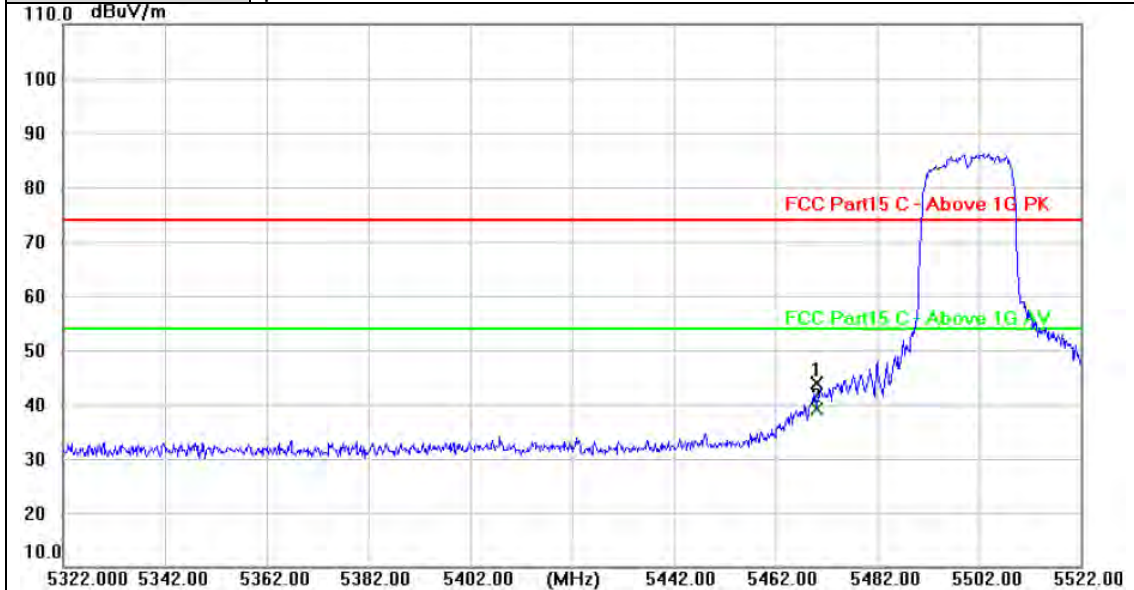

No.	Frequency (MHz)	Reading (dBuV)	Factor (dB/m)	Level (dBuV/m)	Limit (dBuV/m)	Margin (dB)	Detector
1	5470.000	40.26	3.73	43.99	74.00	-30.01	peak
2 *	5470.000	35.49	3.73	39.22	54.00	-14.78	AVG

Remarks:

- 1. Factor (dB/m) = Antenna Factor (dB/m) + Cable Factor (dB) - Pre-amplifier Factor
- 2. Margin value = Level - Limit value



Ant. Pol.:	Horizontal
Test Mode:	TX 802.11n(HT20) Mode 5700MHz (U-NII-2C)
Remark:	No report for the emission which more than 10 dB below the prescribed limit.

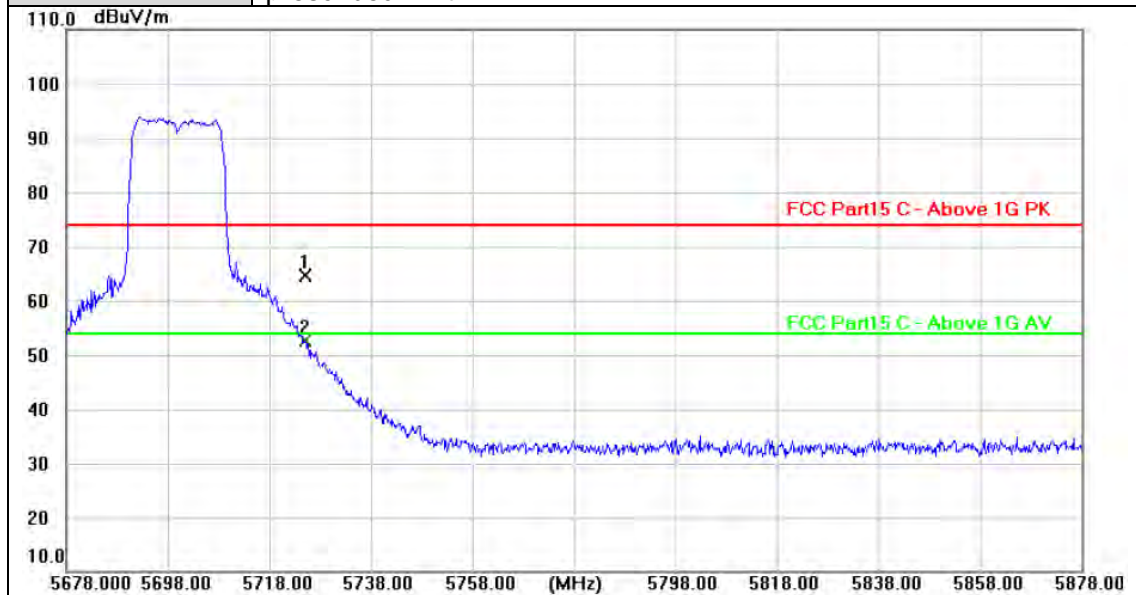

No.	Frequency (MHz)	Reading (dBuV)	Factor (dB/m)	Level (dBuV/m)	Limit (dBuV/m)	Margin (dB)	Detector
1	5725.000	60.12	4.54	64.66	74.00	-9.34	peak
2 *	5725.000	47.99	4.54	52.53	54.00	-1.47	AVG

Remarks:

1. Factor (dB/m) = Antenna Factor (dB/m)+Cable Factor (dB)-Pre-amplifier Factor

2. Margin value = Level -Limit value



Ant. Pol.:	Vertical
Test Mode:	TX 802.11n(HT20) Mode 5700MHz (U-NII-2C)
Remark:	No report for the emission which more than 10 dB below the prescribed limit.

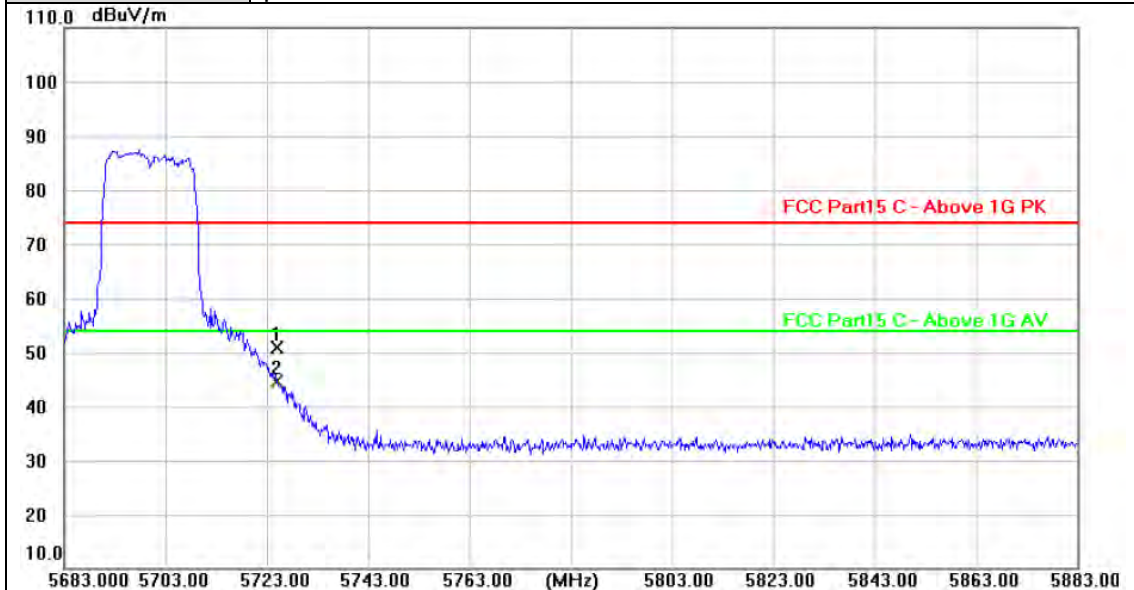

No.	Frequency (MHz)	Reading (dBuV)	Factor (dB/m)	Level (dBuV/m)	Limit (dBuV/m)	Margin (dB)	Detector
1	5725.000	46.45	4.54	50.99	74.00	-23.01	peak
2 *	5725.000	40.16	4.54	44.70	54.00	-9.30	AVG

Remarks:
 1.Factor (dB/m) = Antenna Factor (dB/m)+Cable Factor (dB)-Pre-amplifier Factor
 2.Margin value = Level -Limit value



Ant. Pol.:	Horizontal
Test Mode:	TX 802.11ac(VHT20) Mode 5500MHz (U-NII-2C)
Remark:	No report for the emission which more than 10 dB below the prescribed limit.

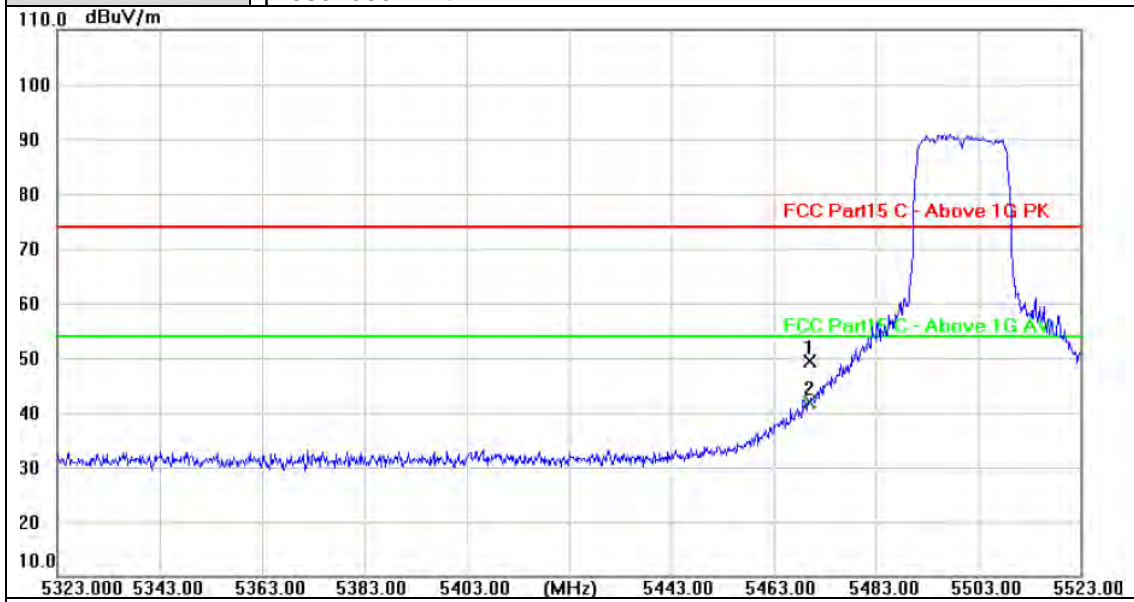

No.	Frequency (MHz)	Reading (dBuV)	Factor (dB/m)	Level (dBuV/m)	Limit (dBuV/m)	Margin (dB)	Detector
1	5470.000	45.71	3.73	49.44	74.00	-24.56	peak
2 *	5470.000	38.03	3.73	41.76	54.00	-12.24	AVG

Remarks:
 1. Factor (dB/m) = Antenna Factor (dB/m)+Cable Factor (dB)-Pre-amplifier Factor
 2. Margin value = Level -Limit value



Ant. Pol.:	Vertical
Test Mode:	TX 802.11ac(VHT20) Mode 5500MHz (U-NII-2C)
Remark:	No report for the emission which more than 10 dB below the prescribed limit.

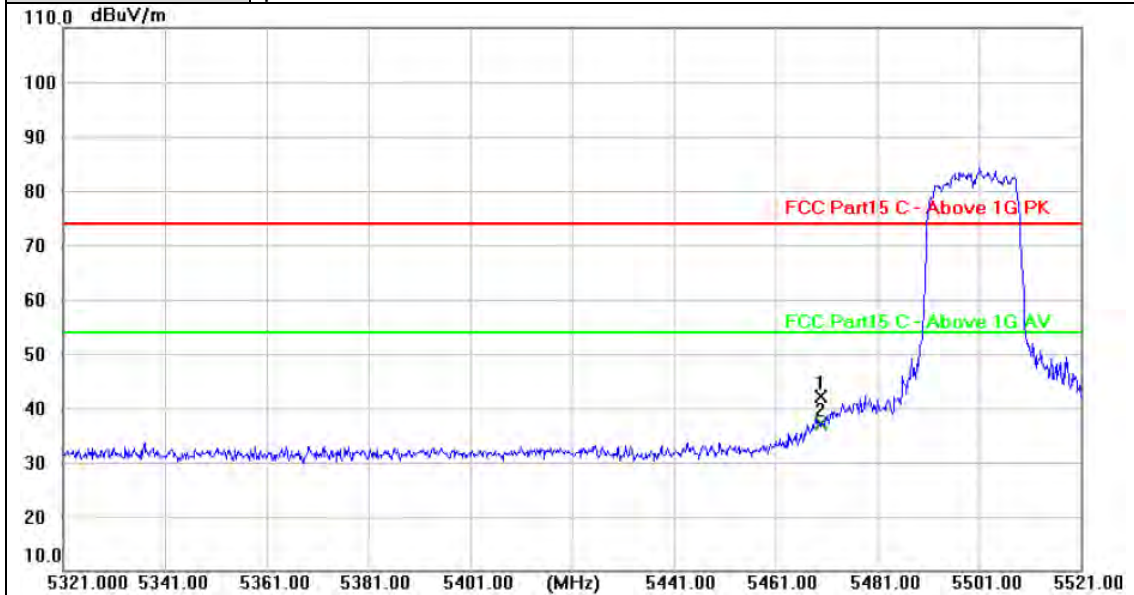

No.	Frequency (MHz)	Reading (dBuV)	Factor (dB/m)	Level (dBuV/m)	Limit (dBuV/m)	Margin (dB)	Detector
1	5470.000	38.46	3.73	42.19	74.00	-31.81	peak
2 *	5470.000	33.45	3.73	37.18	54.00	-16.82	AVG

Remarks:
 1. Factor (dB/m) = Antenna Factor (dB/m)+Cable Factor (dB)-Pre-amplifier Factor
 2. Margin value = Level -Limit value



Ant. Pol.:	Horizontal
Test Mode:	TX 802.11ac(VHT20) Mode 5700MHz (U-NII-2C)
Remark:	No report for the emission which more than 10 dB below the prescribed limit.

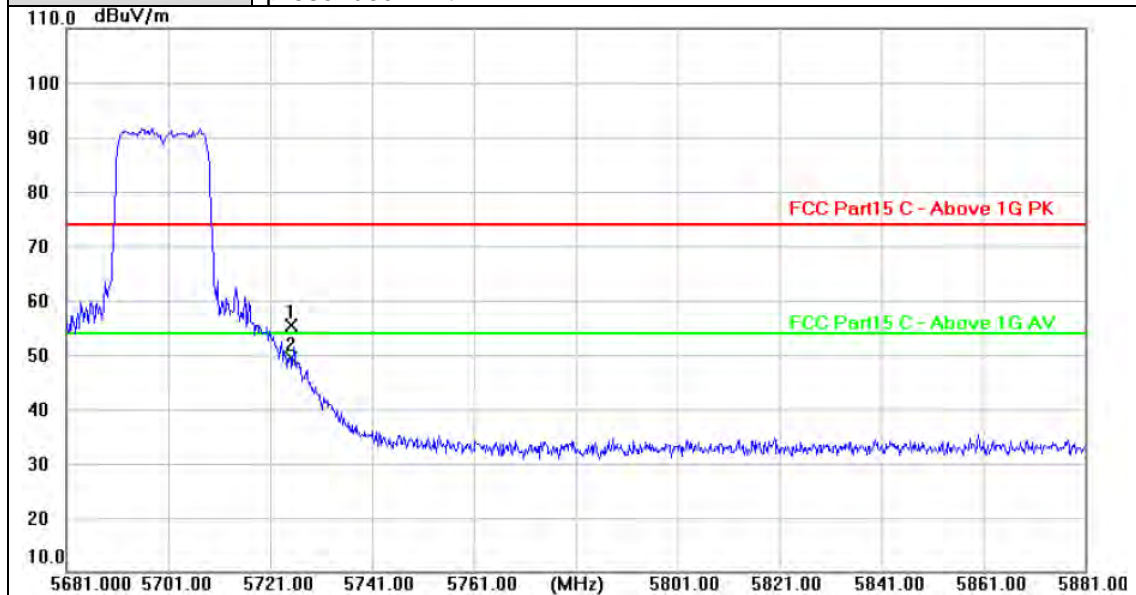

No.	Frequency (MHz)	Reading (dBuV)	Factor (dB/m)	Level (dBuV/m)	Limit (dBuV/m)	Margin (dB)	Detector
1	5725.000	50.84	4.54	55.38	74.00	-18.62	peak
2 *	5725.000	44.86	4.54	49.40	54.00	-4.60	AVG

Remarks:

1. Factor (dB/m) = Antenna Factor (dB/m)+Cable Factor (dB)-Pre-amplifier Factor
2. Margin value = Level -Limit value



Ant. Pol.:	Vertical
Test Mode:	TX 802.11ac(VHT20) Mode 5700MHz (U-NII-2C)
Remark:	No report for the emission which more than 10 dB below the prescribed limit.

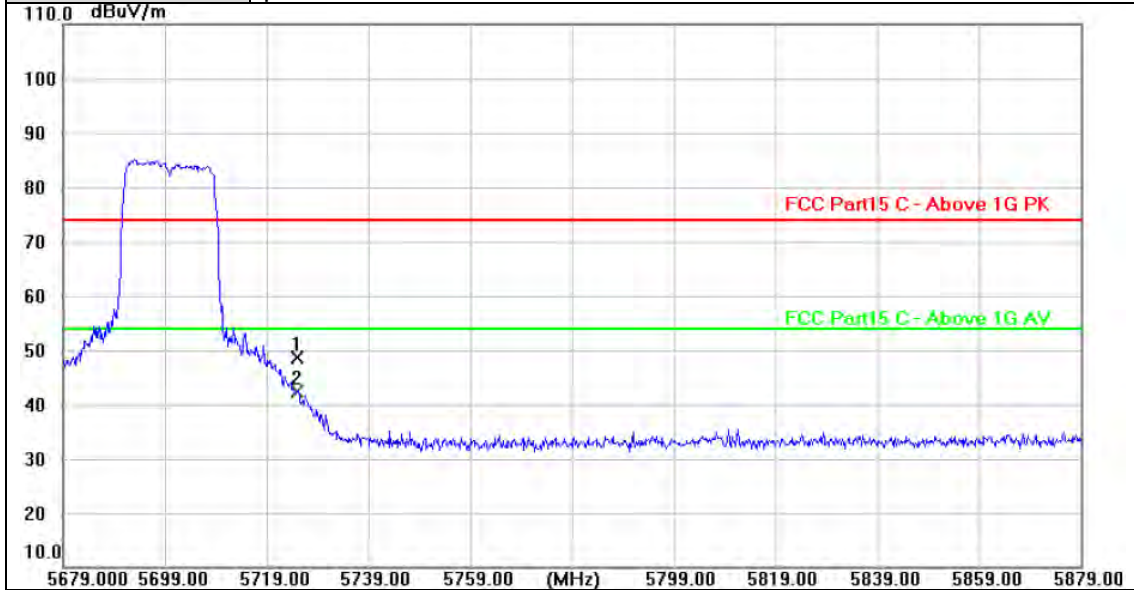

No.	Frequency (MHz)	Reading (dBuV)	Factor (dB/m)	Level (dBuV/m)	Limit (dBuV/m)	Margin (dB)	Detector
1	5725.000	43.99	4.54	48.53	74.00	-25.47	peak
2 *	5725.000	37.79	4.54	42.33	54.00	-11.67	AVG

Remarks:
 1.Factor (dB/m) = Antenna Factor (dB/m)+Cable Factor (dB)-Pre-amplifier Factor
 2.Margin value = Level -Limit value



Ant. Pol.:	Horizontal
Test Mode:	TX 802.11n(HT40) Mode 5510MHz (U-NII-2C)
Remark:	No report for the emission which more than 10 dB below the prescribed limit.

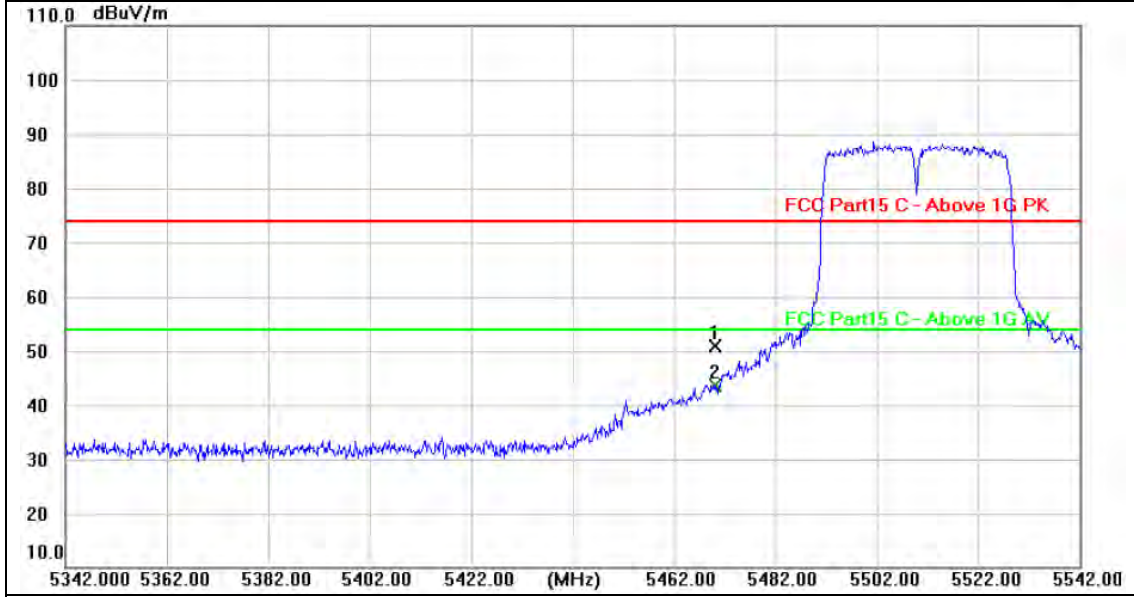

No.	Frequency (MHz)	Reading (dBuV)	Factor (dB/m)	Level (dBuV/m)	Limit (dBuV/m)	Margin (dB)	Detector
1	5470.000	47.26	3.73	50.99	74.00	-23.01	peak
2 *	5470.000	39.81	3.73	43.54	54.00	-10.46	AVG

Remarks:
 1. Factor (dB/m) = Antenna Factor (dB/m)+Cable Factor (dB)-Pre-amplifier Factor
 2. Margin value = Level -Limit value



Ant. Pol.:	Vertical
Test Mode:	TX 802.11n(HT40) Mode 5510MHz (U-NII-2C)
Remark:	No report for the emission which more than 10 dB below the prescribed limit.



No.	Frequency (MHz)	Reading (dBuV)	Factor (dB/m)	Level (dBuV/m)	Limit (dBuV/m)	Margin (dB)	Detector
1	5470.000	46.83	3.73	50.56	74.00	-23.44	peak
2 *	5470.000	39.35	3.73	43.08	54.00	-10.92	AVG

Remarks:
 1. Factor (dB/m) = Antenna Factor (dB/m)+Cable Factor (dB)-Pre-amplifier Factor
 2. Margin value = Level -Limit value

Ant. Pol.:	Horizontal
Test Mode:	TX 802.11n(HT40) Mode 5670MHz (U-NII-2C)
Remark:	No report for the emission which more than 10 dB below the prescribed limit.

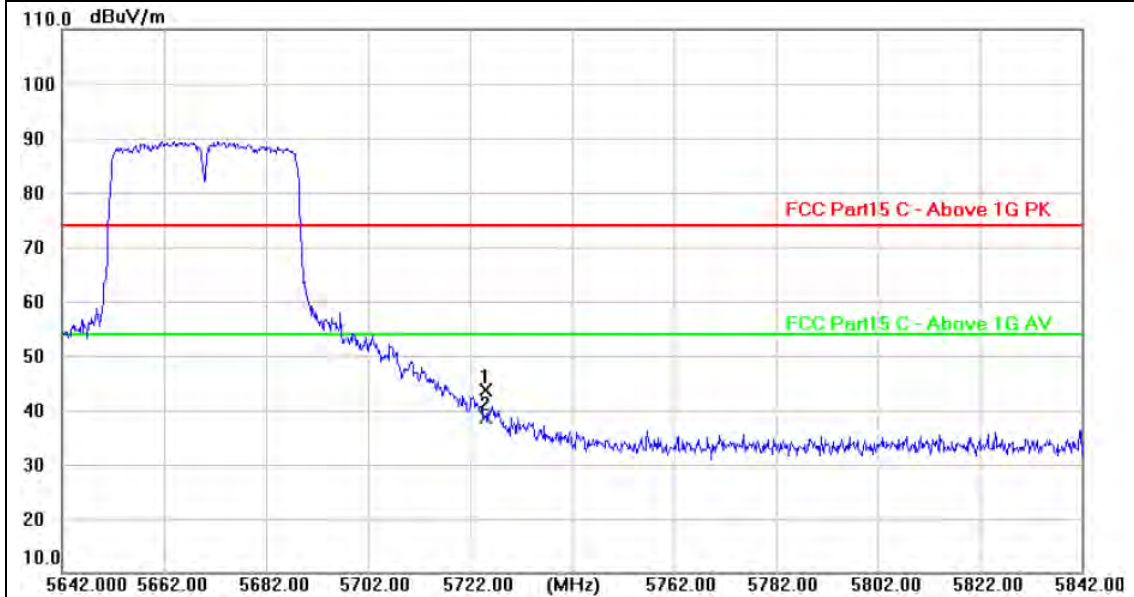

No.	Frequency (MHz)	Reading (dBuV)	Factor (dB/m)	Level (dBuV/m)	Limit (dBuV/m)	Margin (dB)	Detector
1	5725.000	38.98	4.54	43.52	74.00	-30.48	peak
2 *	5725.000	34.16	4.54	38.70	54.00	-15.30	AVG

Remarks:
 1. Factor (dB/m) = Antenna Factor (dB/m)+Cable Factor (dB)-Pre-amplifier Factor
 2. Margin value = Level -Limit value



Ant. Pol.:	Vertical
Test Mode:	TX 802.11n(HT40) Mode 5670MHz (U-NII-2C)
Remark:	No report for the emission which more than 10 dB below the prescribed limit.

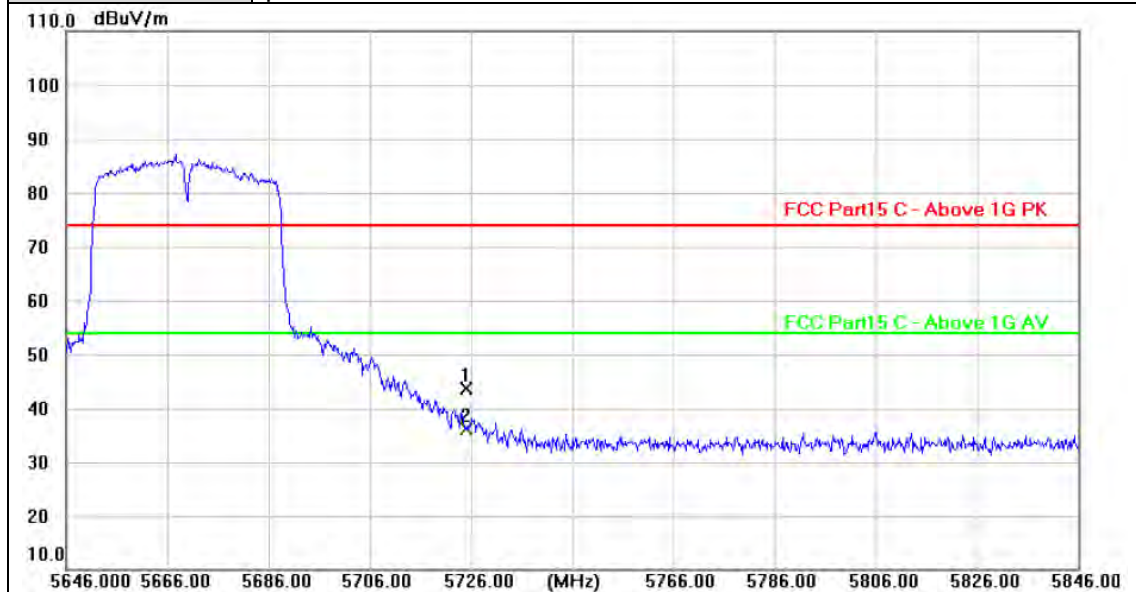

No.	Frequency (MHz)	Reading (dBuV)	Factor (dB/m)	Level (dBuV/m)	Limit (dBuV/m)	Margin (dB)	Detector
1	5725.000	39.08	4.54	43.62	74.00	-30.38	peak
2 *	5725.000	31.64	4.54	36.18	54.00	-17.82	AVG

Remarks:

- 1. Factor (dB/m) = Antenna Factor (dB/m)+Cable Factor (dB)-Pre-amplifier Factor
- 2. Margin value = Level -Limit value



Ant. Pol.:	Horizontal
Test Mode:	TX 802.11ac(VHT40) Mode 5510MHz (U-NII-2C)
Remark:	No report for the emission which more than 10 dB below the prescribed limit.

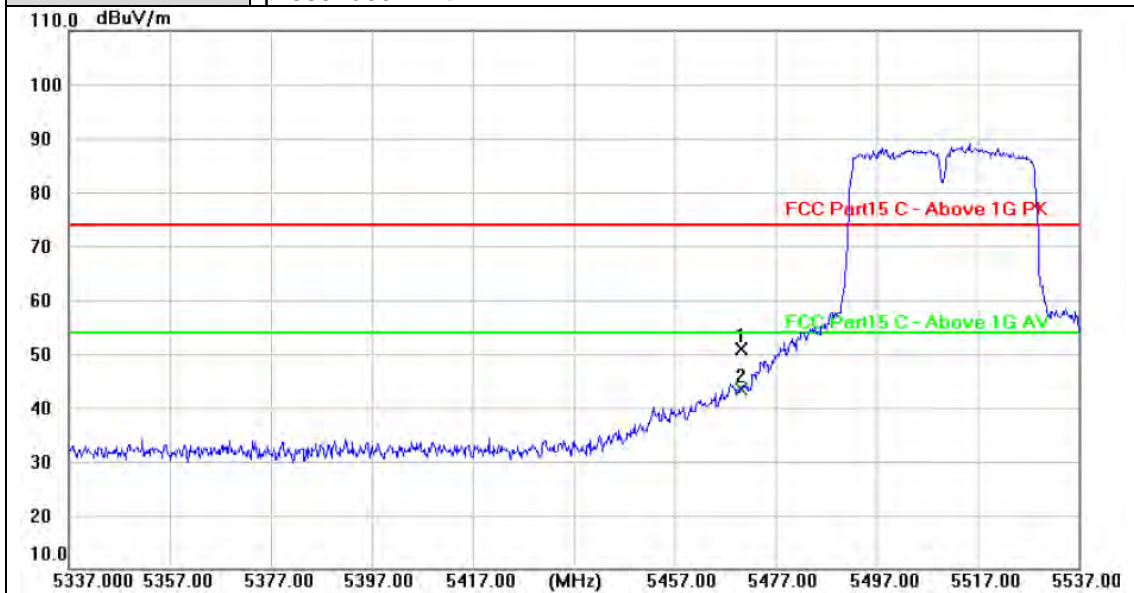

No.	Frequency (MHz)	Reading (dBuV)	Factor (dB/m)	Level (dBuV/m)	Limit (dBuV/m)	Margin (dB)	Detector
1	5470.000	47.23	3.73	50.96	74.00	-23.04	peak
2 *	5470.000	39.75	3.73	43.48	54.00	-10.52	AVG

Remarks:
 1. Factor (dB/m) = Antenna Factor (dB/m)+Cable Factor (dB)-Pre-amplifier Factor
 2. Margin value = Level -Limit value



Ant. Pol.:	Vertical
Test Mode:	TX 802.11ac(VHT40) Mode 5510MHz (U-NII-2C)
Remark:	No report for the emission which more than 10 dB below the prescribed limit.

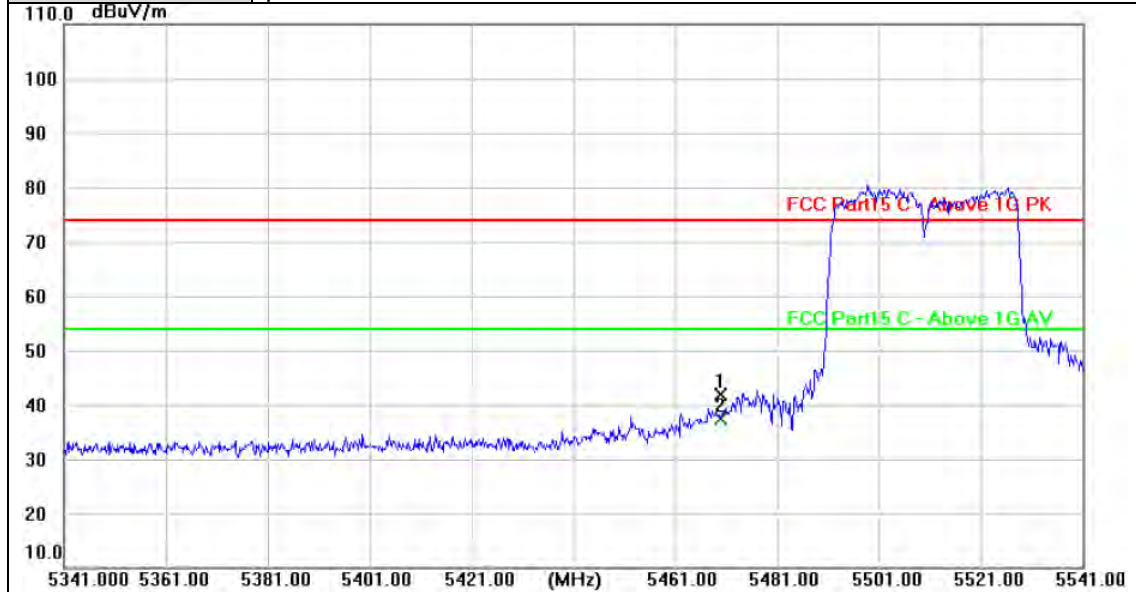

No.	Frequency (MHz)	Reading (dBuV)	Factor (dB/m)	Level (dBuV/m)	Limit (dBuV/m)	Margin (dB)	Detector
1	5470.000	38.10	3.73	41.83	74.00	-32.17	peak
2 *	5470.000	33.55	3.73	37.28	54.00	-16.72	AVG

Remarks:

- Factor (dB/m) = Antenna Factor (dB/m)+Cable Factor (dB)-Pre-amplifier Factor
- Margin value = Level -Limit value



Ant. Pol.:	Horizontal
Test Mode:	TX 802.11ac(VHT40) Mode 5670MHz (U-NII-2C)
Remark:	No report for the emission which more than 10 dB below the prescribed limit.

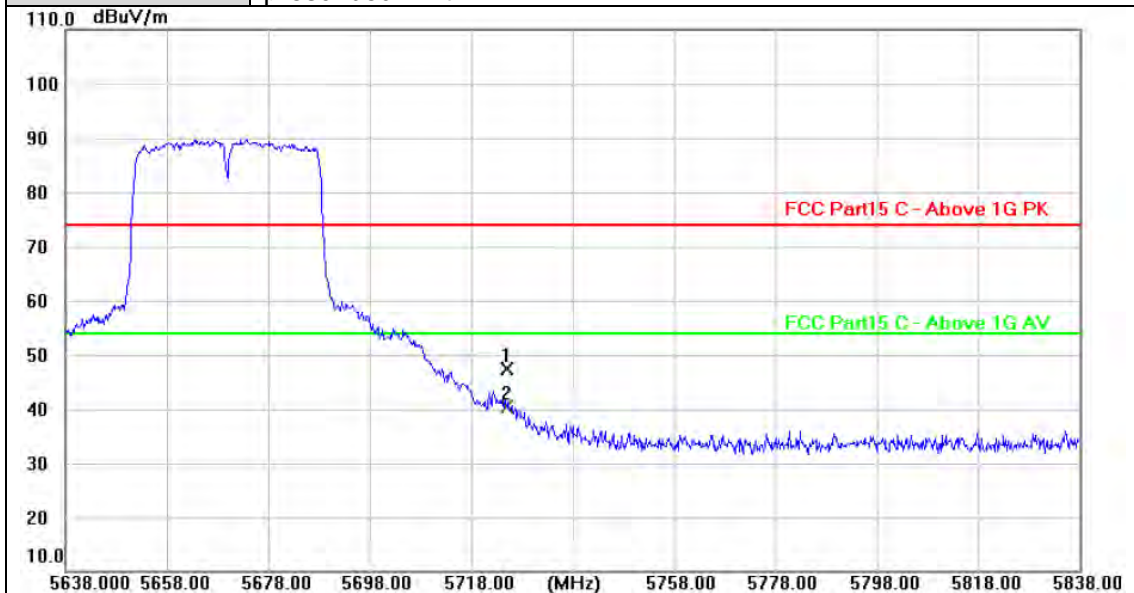

No.	Frequency (MHz)	Reading (dBuV)	Factor (dB/m)	Level (dBuV/m)	Limit (dBuV/m)	Margin (dB)	Detector
1	5725.000	42.72	4.54	47.26	74.00	-26.74	peak
2 *	5725.000	35.92	4.54	40.46	54.00	-13.54	AVG

Remarks:
 1. Factor (dB/m) = Antenna Factor (dB/m)+Cable Factor (dB)-Pre-amplifier Factor
 2. Margin value = Level -Limit value



Ant. Pol.:	Vertical
Test Mode:	TX 802.11ac(VHT40) Mode 5670MHz (U-NII-2C)
Remark:	No report for the emission which more than 10 dB below the prescribed limit.

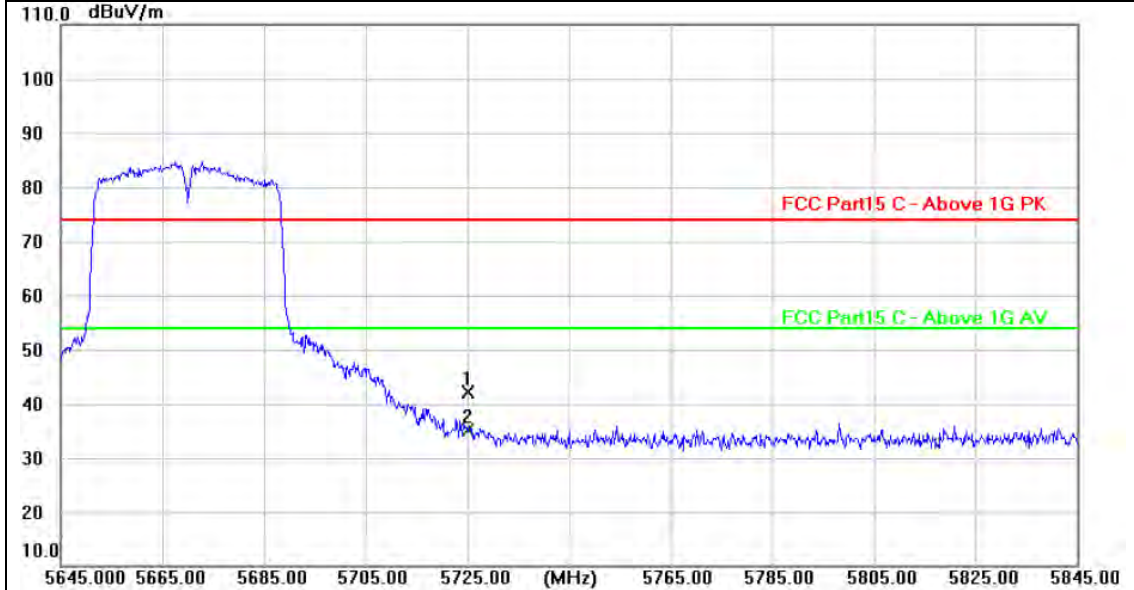

No.	Frequency (MHz)	Reading (dBuV)	Factor (dB/m)	Level (dBuV/m)	Limit (dBuV/m)	Margin (dB)	Detector
1	5725.000	37.56	4.54	42.10	74.00	-31.90	peak
2 *	5725.000	30.47	4.54	35.01	54.00	-18.99	AVG

Remarks:

- 1.Factor (dB/m) = Antenna Factor (dB/m)+Cable Factor (dB)-Pre-amplifier Factor
- 2.Margin value = Level -Limit value



Ant. Pol.:	Horizontal
Test Mode:	TX 802.11ac(VHT80) Mode 5530MHz (U-NII-2C)
Remark:	No report for the emission which more than 10 dB below the prescribed limit.

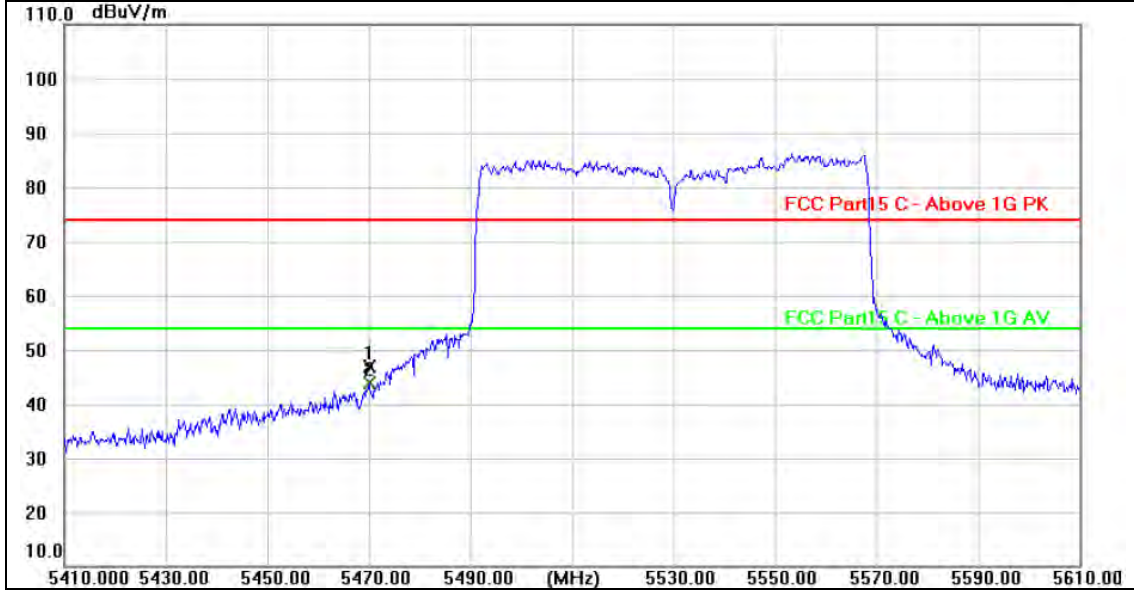

No.	Frequency (MHz)	Reading (dBuV)	Factor (dB/m)	Level (dBuV/m)	Limit (dBuV/m)	Margin (dB)	Detector
1	5470.000	43.03	3.73	46.76	74.00	-27.24	peak
2 *	5470.000	40.10	3.73	43.83	54.00	-10.17	AVG

Remarks:
 1. Factor (dB/m) = Antenna Factor (dB/m)+Cable Factor (dB)-Pre-amplifier Factor
 2. Margin value = Level -Limit value



Ant. Pol.:	Vertical
Test Mode:	TX 802.11ac(VHT80) Mode 5530MHz (U-NII-2C)
Remark:	No report for the emission which more than 10 dB below the prescribed limit.

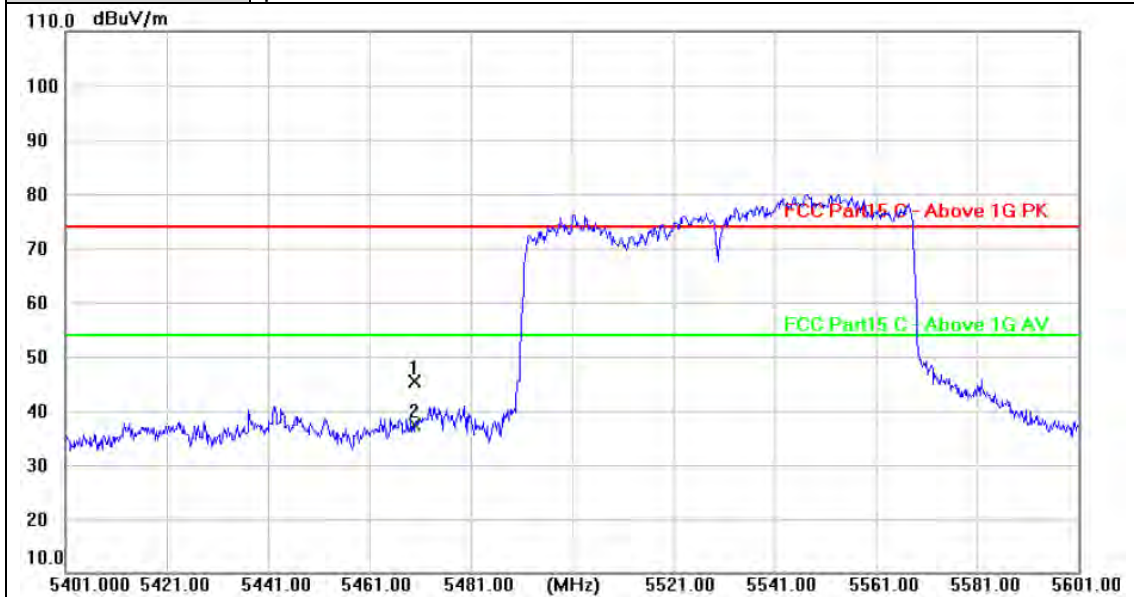

No.	Frequency (MHz)	Reading (dBuV)	Factor (dB/m)	Level (dBuV/m)	Limit (dBuV/m)	Margin (dB)	Detector
1	5470.000	41.63	3.73	45.36	74.00	-28.64	peak
2 *	5470.000	33.66	3.73	37.39	54.00	-16.61	AVG

Remarks:
 1. Factor (dB/m) = Antenna Factor (dB/m)+Cable Factor (dB)-Pre-amplifier Factor
 2. Margin value = Level -Limit value



Ant. Pol.:	Horizontal
Test Mode:	TX 802.11ac(VHT80) Mode 5610MHz (U-NII-2C)
Remark:	No report for the emission which more than 10 dB below the prescribed limit.

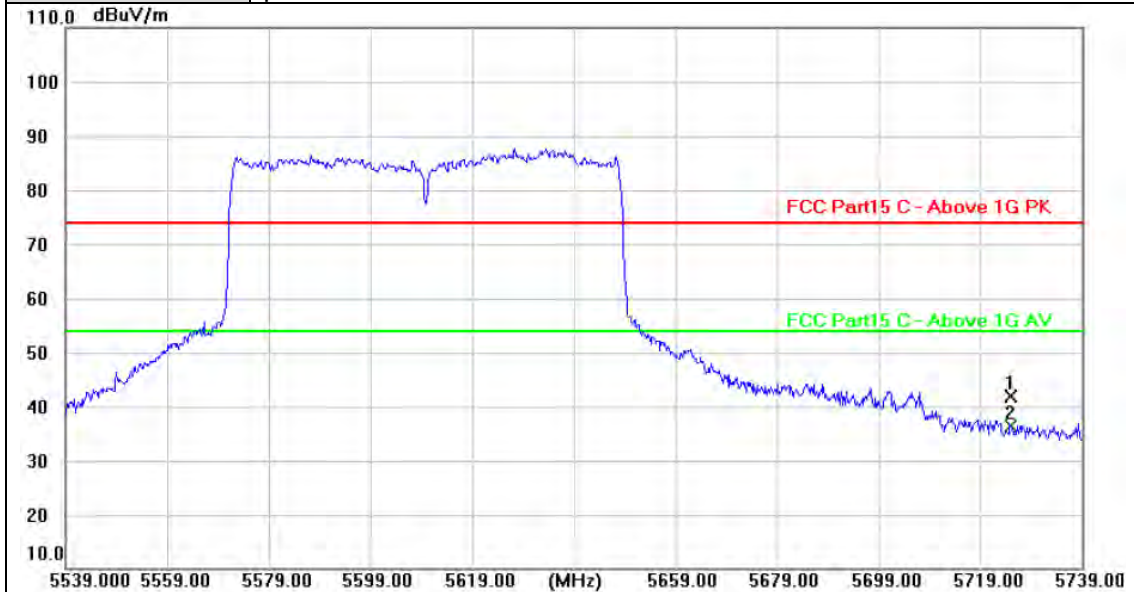

No.	Frequency (MHz)	Reading (dBuV)	Factor (dB/m)	Level (dBuV/m)	Limit (dBuV/m)	Margin (dB)	Detector
1	5725.000	37.35	4.54	41.89	74.00	-32.11	peak
2 *	5725.000	31.79	4.54	36.33	54.00	-17.67	AVG

Remarks:
 1. Factor (dB/m) = Antenna Factor (dB/m)+Cable Factor (dB)-Pre-amplifier Factor
 2. Margin value = Level -Limit value



Ant. Pol.:	Vertical
Test Mode:	TX 802.11ac(VHT80) Mode 5610MHz (U-NII-2C)
Remark:	No report for the emission which more than 10 dB below the prescribed limit.

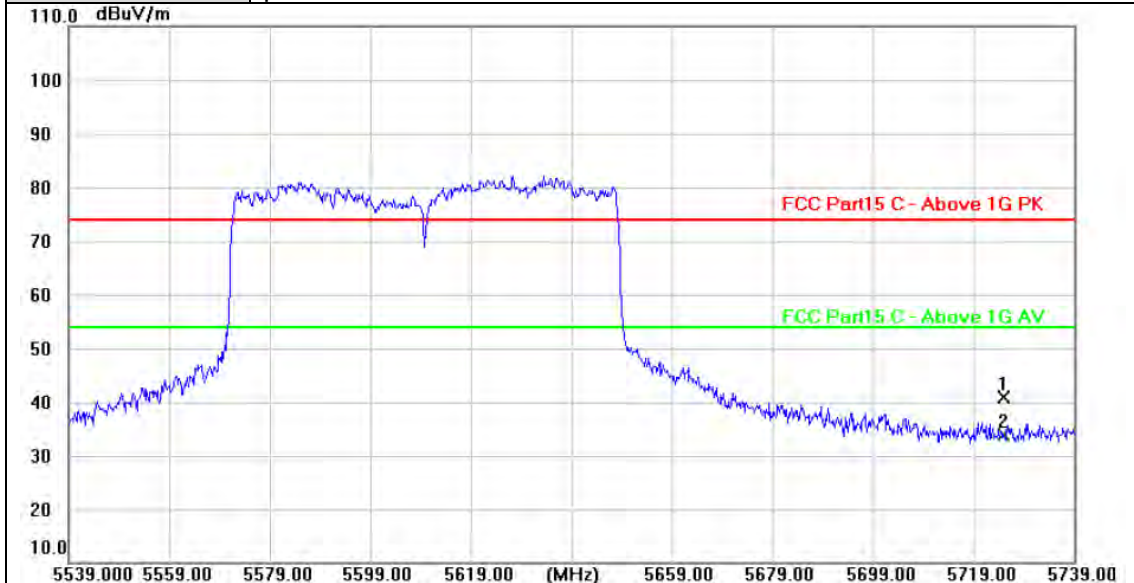

No.	Frequency (MHz)	Reading (dBuV)	Factor (dB/m)	Level (dBuV/m)	Limit (dBuV/m)	Margin (dB)	Detector
1	5725.000	36.28	4.54	40.82	74.00	-33.18	peak
2 *	5725.000	29.40	4.54	33.94	54.00	-20.06	AVG

Remarks:

- 1. Factor (dB/m) = Antenna Factor (dB/m)+Cable Factor (dB)-Pre-amplifier Factor
- 2. Margin value = Level -Limit value

Ant. Pol.:	Horizontal
Test Mode:	TX 802.11a Mode 5745MHz (U-NII-3)
Remark:	No report for the emission which more than 10 dB below the prescribed limit.

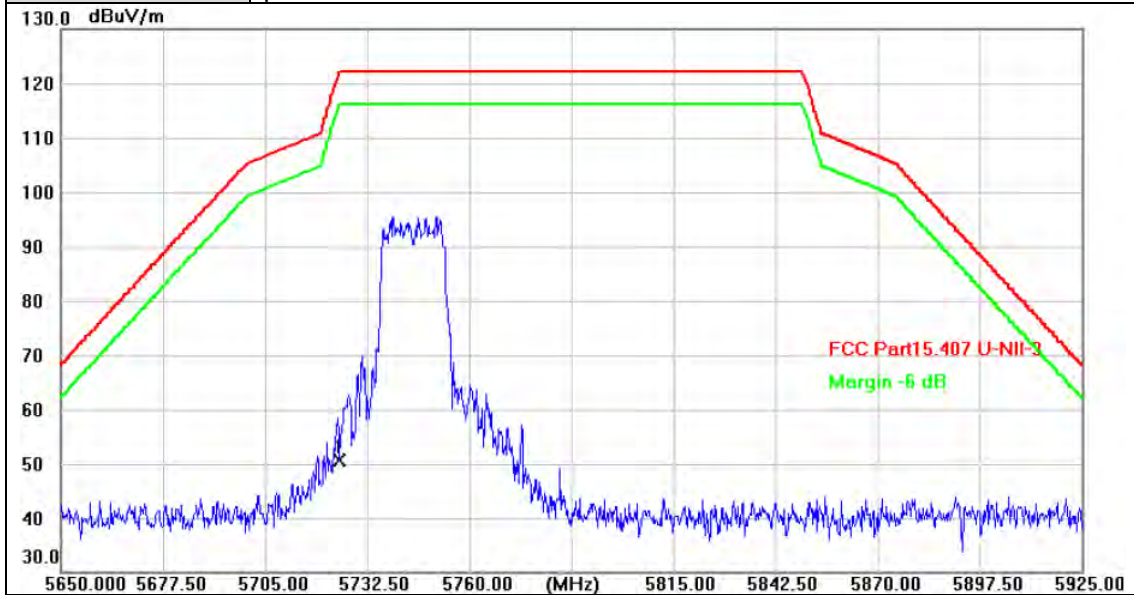

No.	Frequency (MHz)	Reading (dBuV)	Factor (dB/m)	Level (dBuV/m)	Limit (dBuV/m)	Margin (dB)	Detector
1 *	5725.000	46.19	4.54	50.73	122.20	-71.47	peak

Remarks:

- Factor (dB/m) = Antenna Factor (dB/m)+Cable Factor (dB)-Pre-amplifier Factor
- Margin value = Level -Limit value



Ant. Pol.:	Vertical
Test Mode:	TX 802.11a Mode 5745MHz (U-NII-3)
Remark:	No report for the emission which more than 10 dB below the prescribed limit.

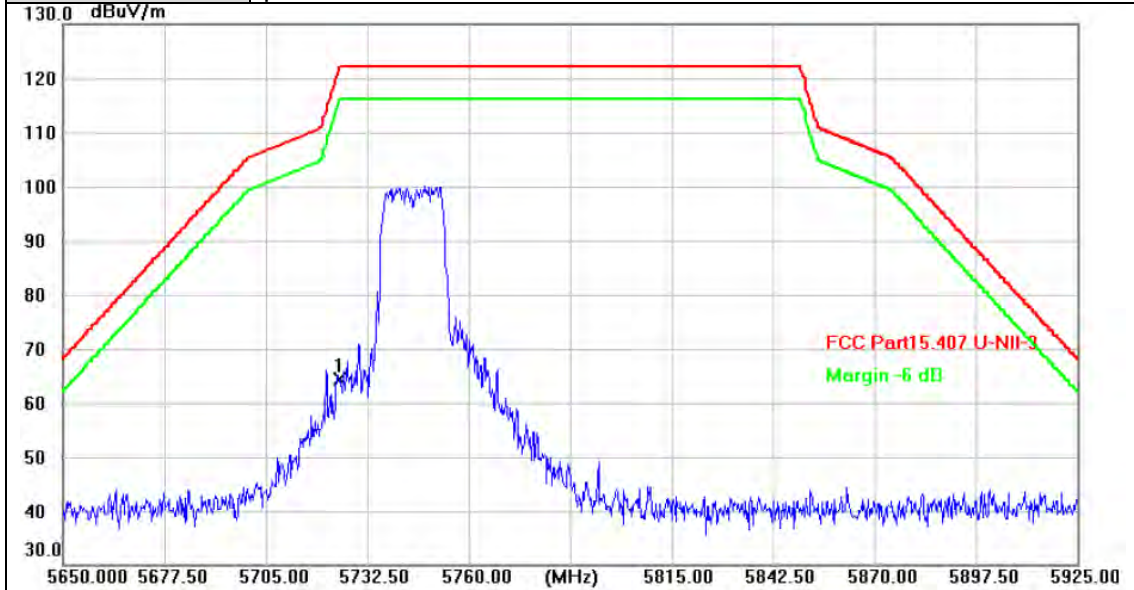

No.	Frequency (MHz)	Reading (dBuV)	Factor (dB/m)	Level (dBuV/m)	Limit (dBuV/m)	Margin (dB)	Detector
1 *	5725.000	59.84	4.54	64.38	122.20	-57.82	peak

Remarks:
 1.Factor (dB/m) = Antenna Factor (dB/m)+Cable Factor (dB)-Pre-amplifier Factor
 2.Margin value = Level -Limit value



Ant. Pol.:	Horizontal
Test Mode:	TX 802.11a Mode 5825MHz (U-NII-3)
Remark:	No report for the emission which more than 10 dB below the prescribed limit.

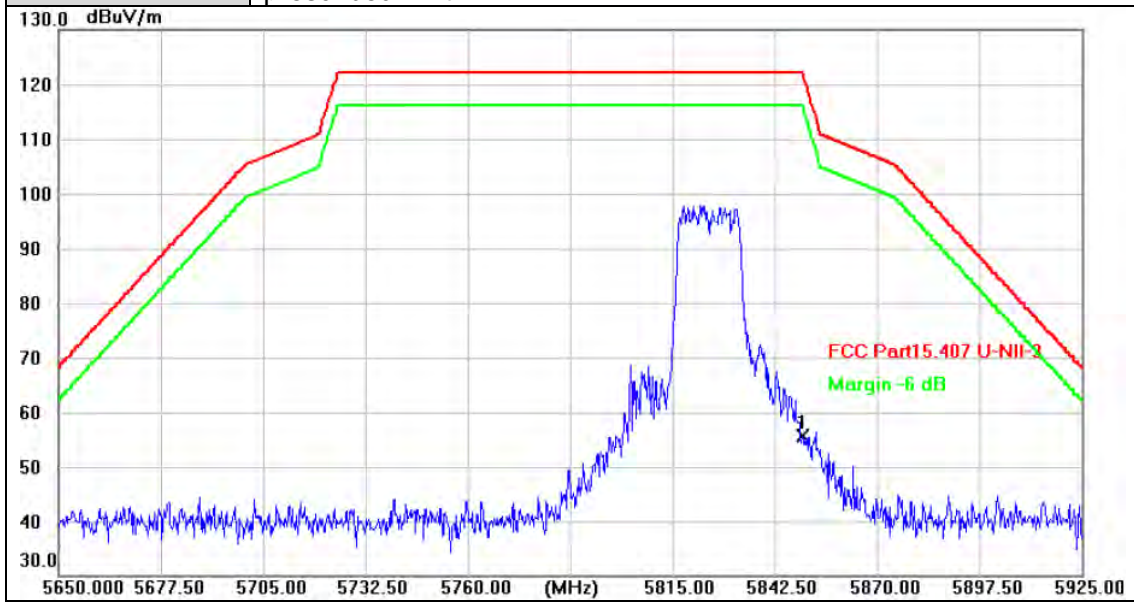

No.	Frequency (MHz)	Reading (dBuV)	Factor (dB/m)	Level (dBuV/m)	Limit (dBuV/m)	Margin (dB)	Detector
1 *	5850.000	50.59	4.95	55.54	122.20	-66.66	peak

Remarks:
 1. Factor (dB/m) = Antenna Factor (dB/m)+Cable Factor (dB)-Pre-amplifier Factor
 2. Margin value = Level -Limit value

Ant. Pol.:	Vertical
Test Mode:	TX 802.11a Mode 5825MHz (U-NII-3)
Remark:	No report for the emission which more than 10 dB below the prescribed limit.

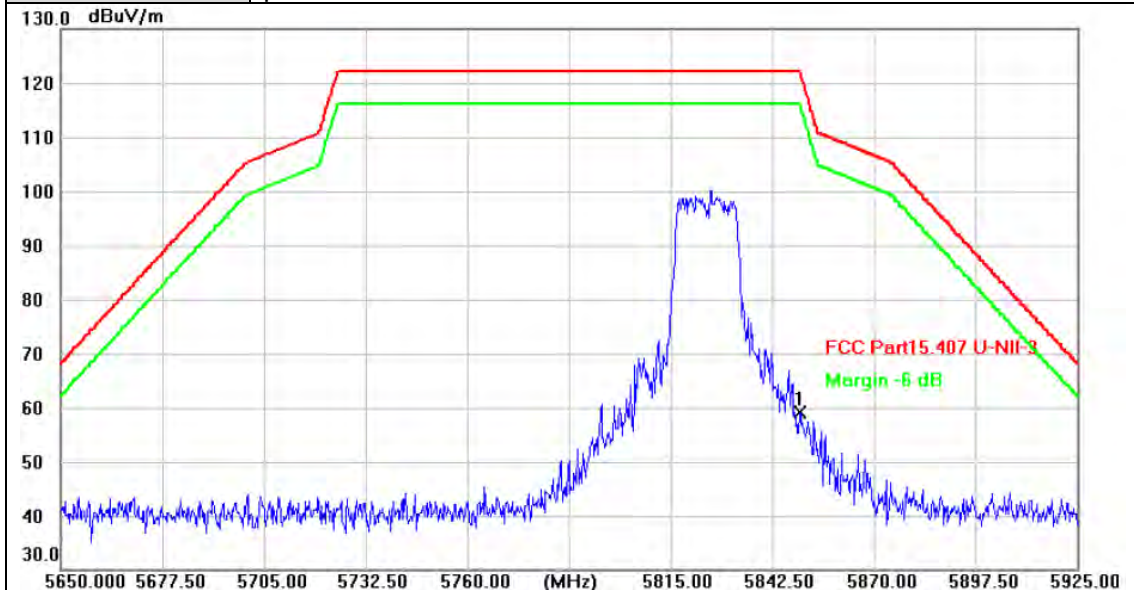

No.	Frequency (MHz)	Reading (dBuV)	Factor (dB/m)	Level (dBuV/m)	Limit (dBuV/m)	Margin (dB)	Detector
1 *	5850.000	54.21	4.95	59.16	122.20	-63.04	peak

Remarks:

1. Factor (dB/m) = Antenna Factor (dB/m)+Cable Factor (dB)-Pre-amplifier Factor
2. Margin value = Level -Limit value



Ant. Pol.:	Horizontal
Test Mode:	TX 802.11n(HT20) Mode 5745MHz (U-NII-3)
Remark:	No report for the emission which more than 10 dB below the prescribed limit.

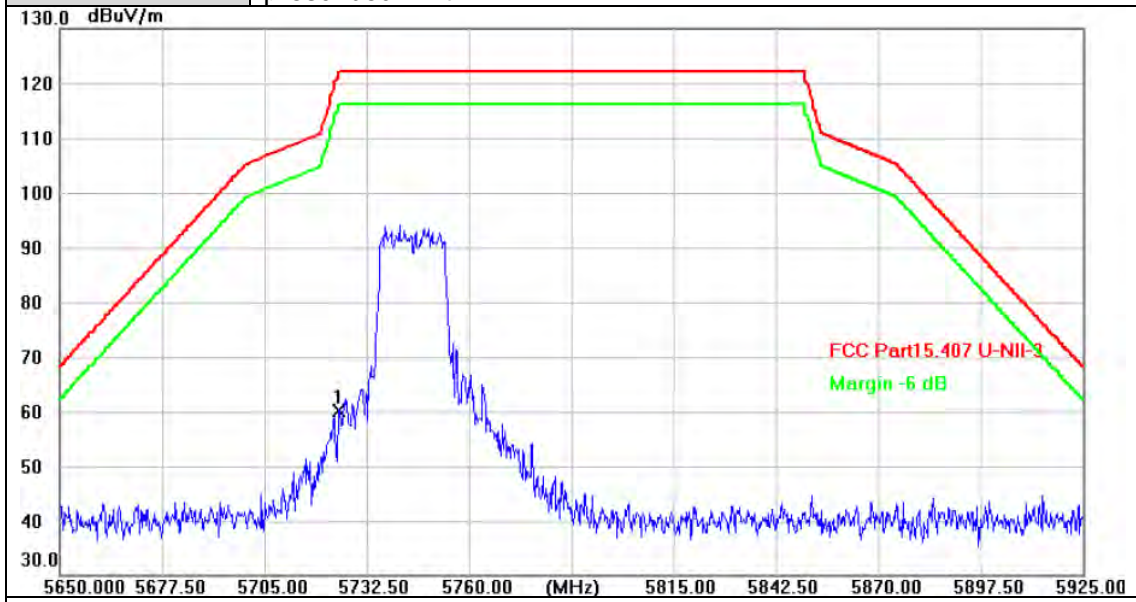

No.	Frequency (MHz)	Reading (dBuV)	Factor (dB/m)	Level (dBuV/m)	Limit (dBuV/m)	Margin (dB)	Detector
1 *	5725.000	55.54	4.54	60.08	122.20	-62.12	peak

Remarks:
 1. Factor (dB/m) = Antenna Factor (dB/m)+Cable Factor (dB)-Pre-amplifier Factor
 2. Margin value = Level -Limit value



Ant. Pol.:	Vertical
Test Mode:	TX 802.11n(HT20) Mode 5745MHz (U-NII-3)
Remark:	No report for the emission which more than 10 dB below the prescribed limit.

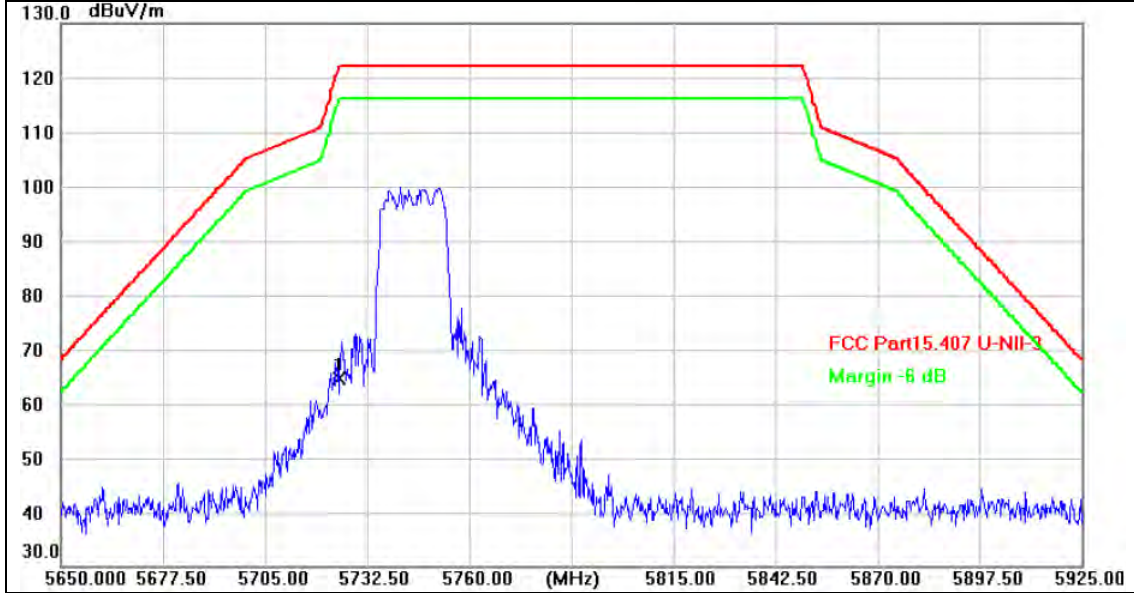

No.	Frequency (MHz)	Reading (dBuV)	Factor (dB/m)	Level (dBuV/m)	Limit (dBuV/m)	Margin (dB)	Detector
1 *	5725.000	60.01	4.54	64.55	122.20	-57.65	peak

Remarks:

- Factor (dB/m) = Antenna Factor (dB/m)+Cable Factor (dB)-Pre-amplifier Factor
- Margin value = Level -Limit value



Ant. Pol.:	Horizontal
Test Mode:	TX 802.11n(HT20) Mode 5825MHz (U-NII-3)
Remark:	No report for the emission which more than 10 dB below the prescribed limit.

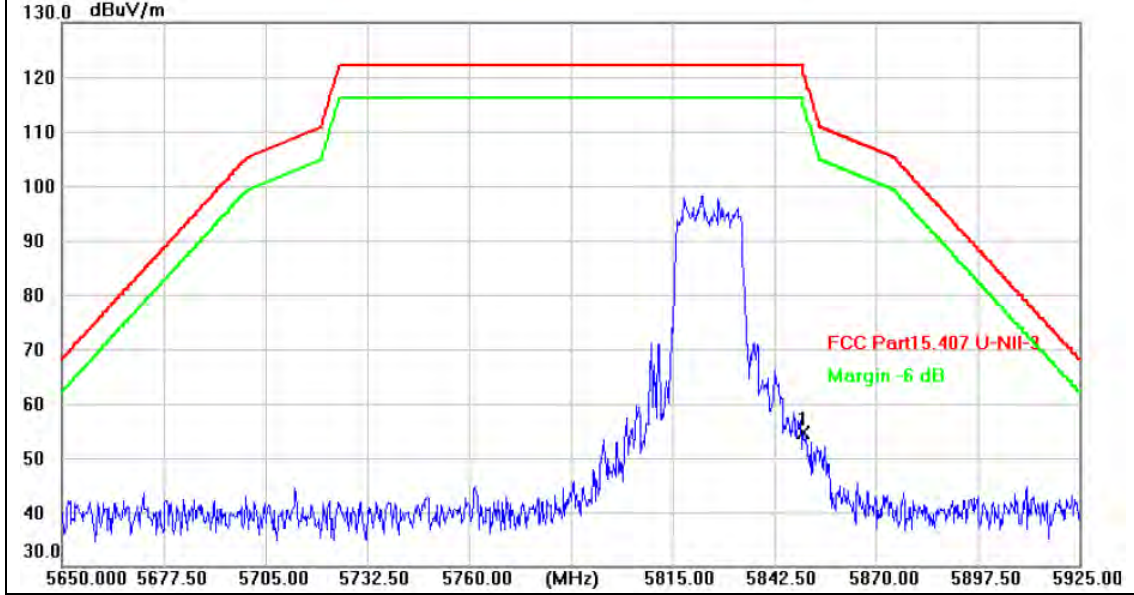

No.	Frequency (MHz)	Reading (dBuV)	Factor (dB/m)	Level (dBuV/m)	Limit (dBuV/m)	Margin (dB)	Detector
1 *	5850.000	49.73	4.95	54.68	122.20	-67.52	peak

Remarks:
 1. Factor (dB/m) = Antenna Factor (dB/m)+Cable Factor (dB)-Pre-amplifier Factor
 2. Margin value = Level -Limit value



Ant. Pol.:	Vertical
Test Mode:	TX 802.11n(HT20) Mode 5825MHz (U-NII-3)
Remark:	No report for the emission which more than 10 dB below the prescribed limit.

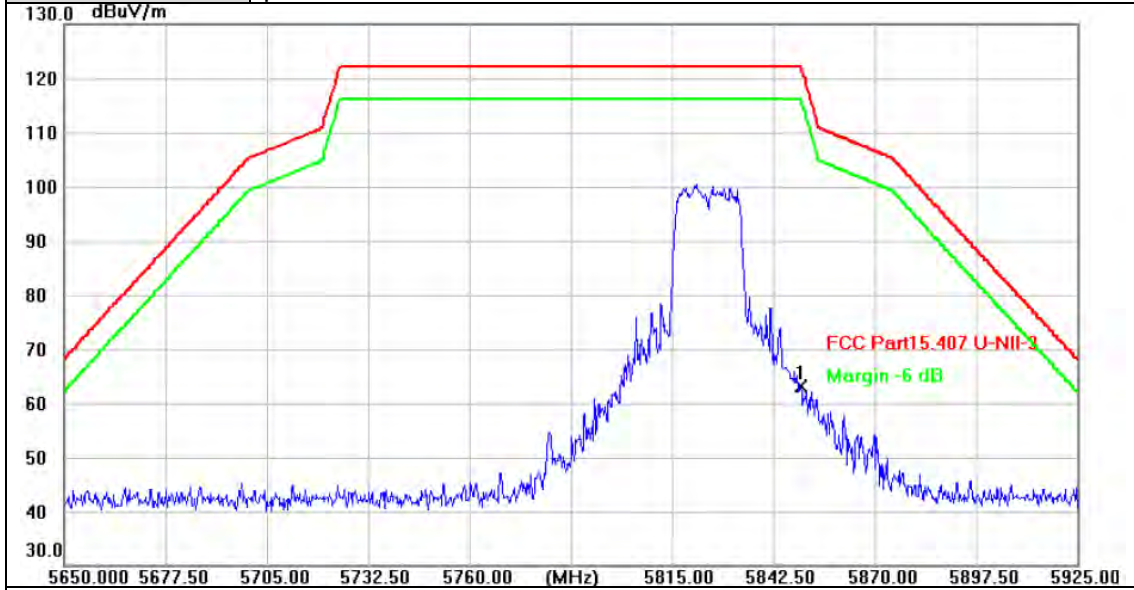

No.	Frequency (MHz)	Reading (dBuV)	Factor (dB/m)	Level (dBuV/m)	Limit (dBuV/m)	Margin (dB)	Detector
1 *	5850.000	58.30	4.95	63.25	122.20	-58.95	peak

Remarks:
 1. Factor (dB/m) = Antenna Factor (dB/m)+Cable Factor (dB)-Pre-amplifier Factor
 2. Margin value = Level -Limit value



Ant. Pol.:	Horizontal
Test Mode:	TX 802.11ac(VHT20) Mode 5745MHz (U-NII-3)
Remark:	No report for the emission which more than 10 dB below the prescribed limit.

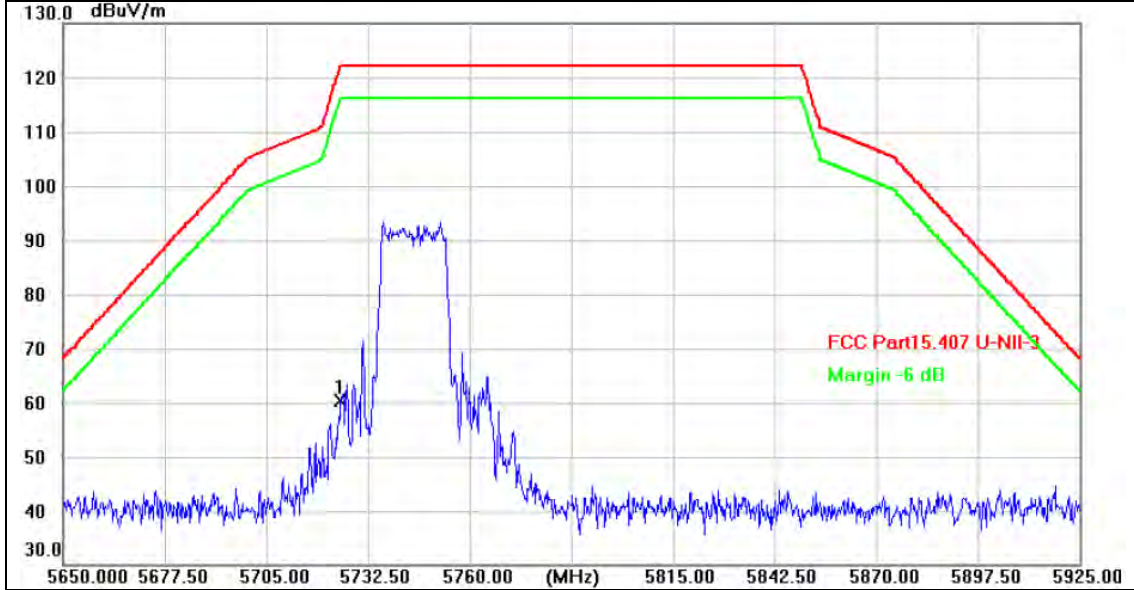

No.	Frequency (MHz)	Reading (dBuV)	Factor (dB/m)	Level (dBuV/m)	Limit (dBuV/m)	Margin (dB)	Detector
1 *	5725.000	55.96	4.54	60.50	122.20	-61.70	peak

Remarks:
 1. Factor (dB/m) = Antenna Factor (dB/m)+Cable Factor (dB)-Pre-amplifier Factor
 2. Margin value = Level -Limit value



Ant. Pol.:	Vertical
Test Mode:	TX 802.11ac(VHT20) Mode 5745MHz (U-NII-3)
Remark:	No report for the emission which more than 10 dB below the prescribed limit.

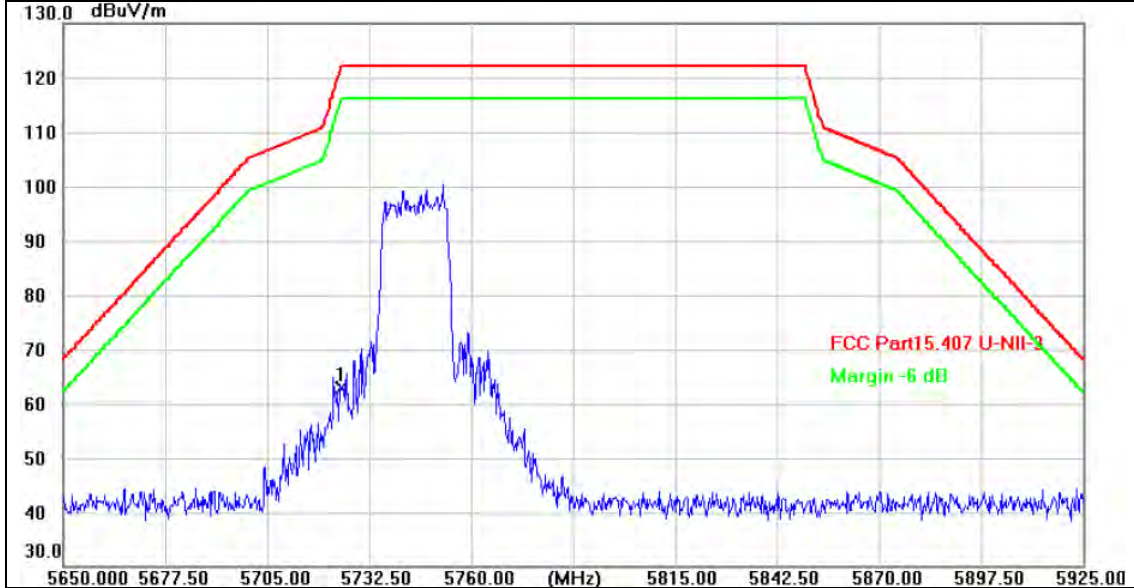

No.	Frequency (MHz)	Reading (dBuV)	Factor (dB/m)	Level (dBuV/m)	Limit (dBuV/m)	Margin (dB)	Detector
1 *	5725.000	58.41	4.54	62.95	122.20	-59.25	peak

Remarks:

- 1.Factor (dB/m) = Antenna Factor (dB/m)+Cable Factor (dB)-Pre-amplifier Factor
- 2.Margin value = Level -Limit value



Ant. Pol.:	Horizontal
Test Mode:	TX 802.11ac(VHT20) Mode 5825MHz (U-NII-3)
Remark:	No report for the emission which more than 10 dB below the prescribed limit.

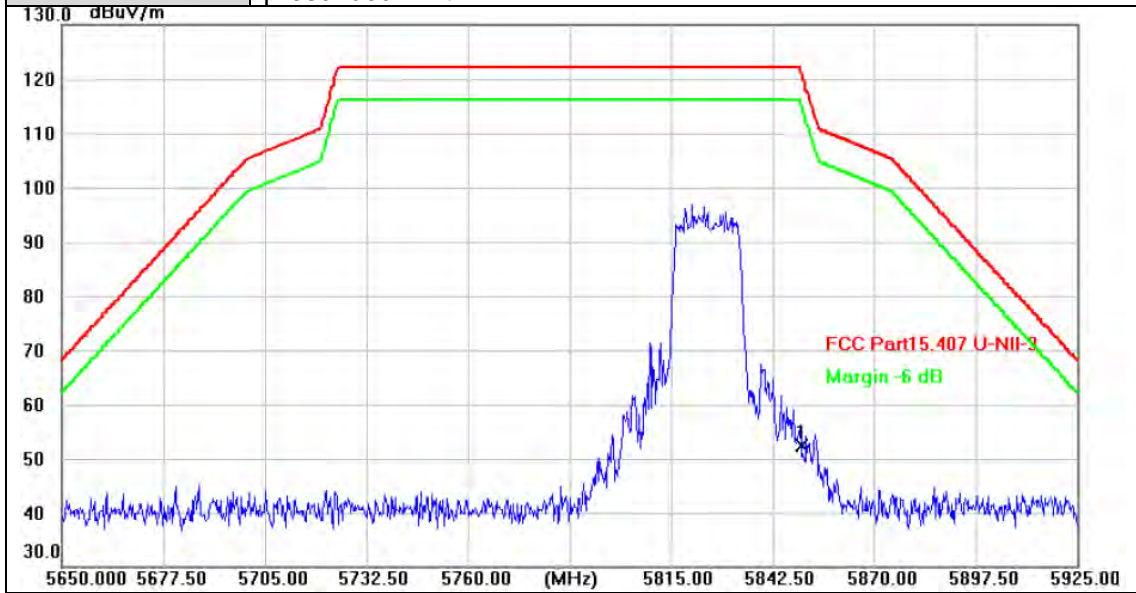

No.	Frequency (MHz)	Reading (dBuV)	Factor (dB/m)	Level (dBuV/m)	Limit (dBuV/m)	Margin (dB)	Detector
1 *	5850.000	47.55	4.95	52.50	122.20	-69.70	peak

Remarks:
 1. Factor (dB/m) = Antenna Factor (dB/m)+Cable Factor (dB)-Pre-amplifier Factor
 2. Margin value = Level -Limit value



Ant. Pol.:	Vertical
Test Mode:	TX 802.11ac(VHT20) Mode 5825MHz (U-NII-3)
Remark:	No report for the emission which more than 10 dB below the prescribed limit.

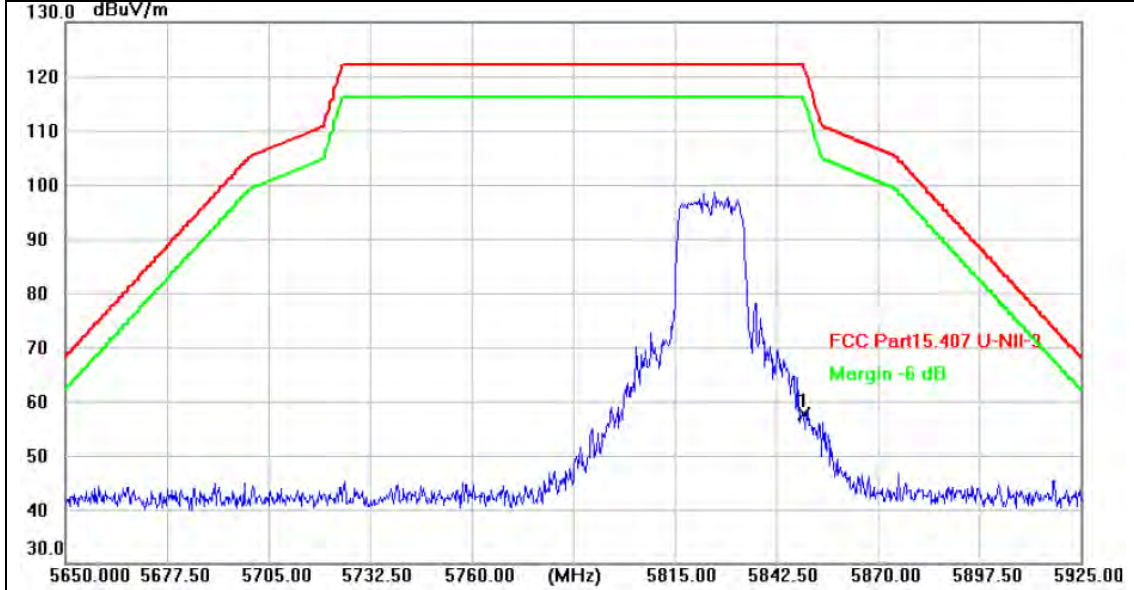

No.	Frequency (MHz)	Reading (dBuV)	Factor (dB/m)	Level (dBuV/m)	Limit (dBuV/m)	Margin (dB)	Detector
1 *	5850.000	52.80	4.95	57.75	122.20	-64.45	peak

Remarks:

- 1. Factor (dB/m) = Antenna Factor (dB/m)+Cable Factor (dB)-Pre-amplifier Factor
- 2. Margin value = Level -Limit value



Ant. Pol.:	Horizontal
Test Mode:	TX 802.11n(HT40) Mode 5755MHz (U-NII-3)
Remark:	No report for the emission which more than 10 dB below the prescribed limit.

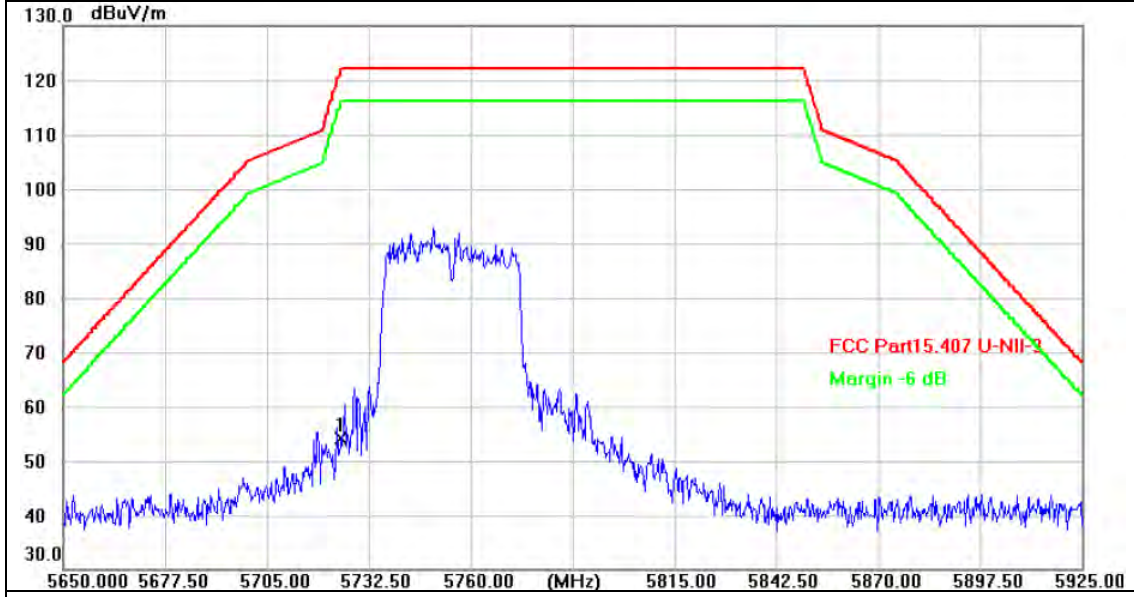

No.	Frequency (MHz)	Reading (dBuV)	Factor (dB/m)	Level (dBuV/m)	Limit (dBuV/m)	Margin (dB)	Detector
1 *	5725.000	49.58	4.54	54.12	122.20	-68.08	peak

Remarks:
 1. Factor (dB/m) = Antenna Factor (dB/m)+Cable Factor (dB)-Pre-amplifier Factor
 2. Margin value = Level -Limit value



Ant. Pol.:	Vertical
Test Mode:	TX 802.11n(HT40) Mode 5755MHz (U-NII-3)
Remark:	No report for the emission which more than 10 dB below the prescribed limit.

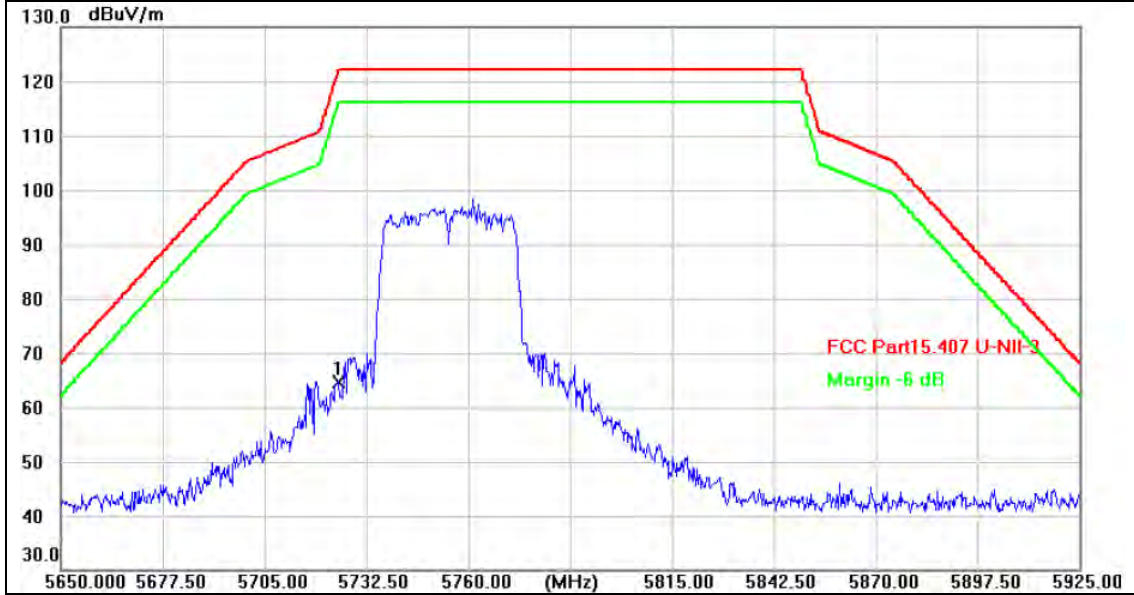

No.	Frequency (MHz)	Reading (dBuV)	Factor (dB/m)	Level (dBuV/m)	Limit (dBuV/m)	Margin (dB)	Detector
1 *	5725.000	60.08	4.54	64.62	122.20	-57.58	peak

Remarks:
 1. Factor (dB/m) = Antenna Factor (dB/m)+Cable Factor (dB)-Pre-amplifier Factor
 2. Margin value = Level -Limit value



Ant. Pol.:	Horizontal
Test Mode:	TX 802.11n(HT40) Mode 5795MHz (U-NII-3)
Remark:	No report for the emission which more than 10 dB below the prescribed limit.

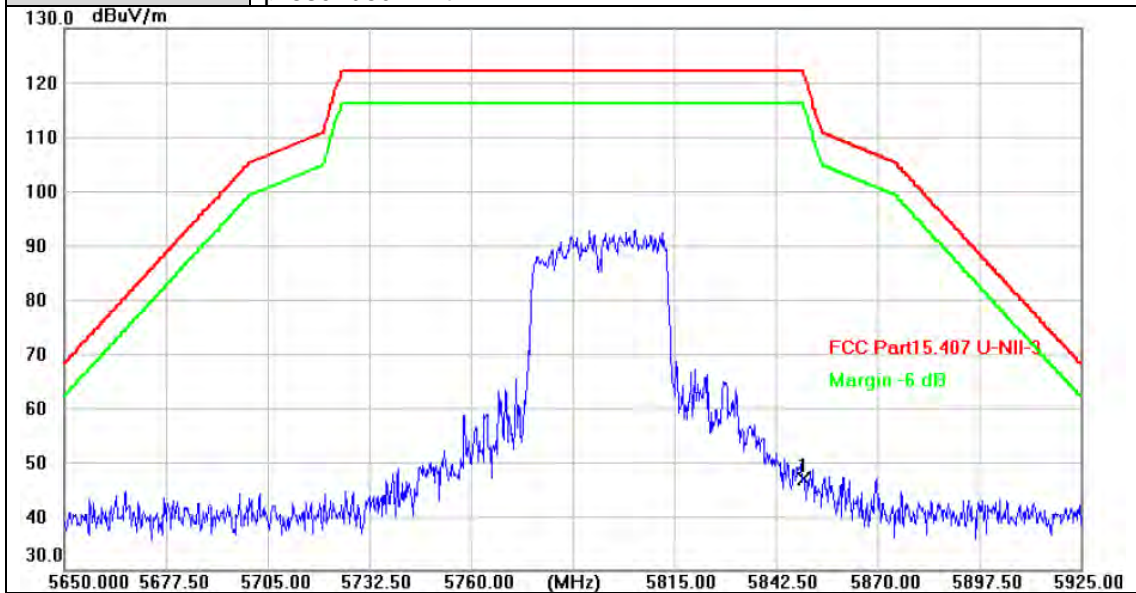

No.	Frequency (MHz)	Reading (dBuV)	Factor (dB/m)	Level (dBuV/m)	Limit (dBuV/m)	Margin (dB)	Detector
1 *	5850.000	42.01	4.95	46.96	122.20	-75.24	peak

Remarks:
 1. Factor (dB/m) = Antenna Factor (dB/m)+Cable Factor (dB)-Pre-amplifier Factor
 2. Margin value = Level -Limit value



Ant. Pol.:	Vertical
Test Mode:	TX 802.11n(HT40) Mode 5795MHz (U-NII-3)
Remark:	No report for the emission which more than 10 dB below the prescribed limit.

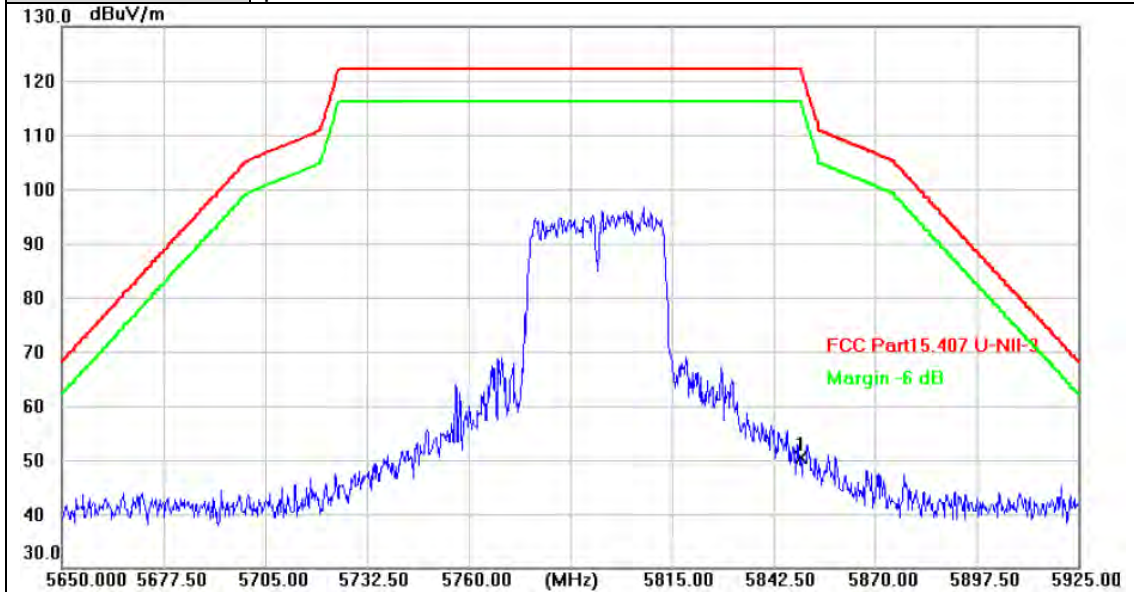

No.	Frequency (MHz)	Reading (dBuV)	Factor (dB/m)	Level (dBuV/m)	Limit (dBuV/m)	Margin (dB)	Detector
1 *	5850.000	45.48	4.95	50.43	122.20	-71.77	peak

Remarks:

- 1. Factor (dB/m) = Antenna Factor (dB/m)+Cable Factor (dB)-Pre-amplifier Factor
- 2. Margin value = Level -Limit value



Ant. Pol.:	Horizontal
Test Mode:	TX 802.11ac(VHT40) Mode 5755MHz (U-NII-3)
Remark:	No report for the emission which more than 10 dB below the prescribed limit.

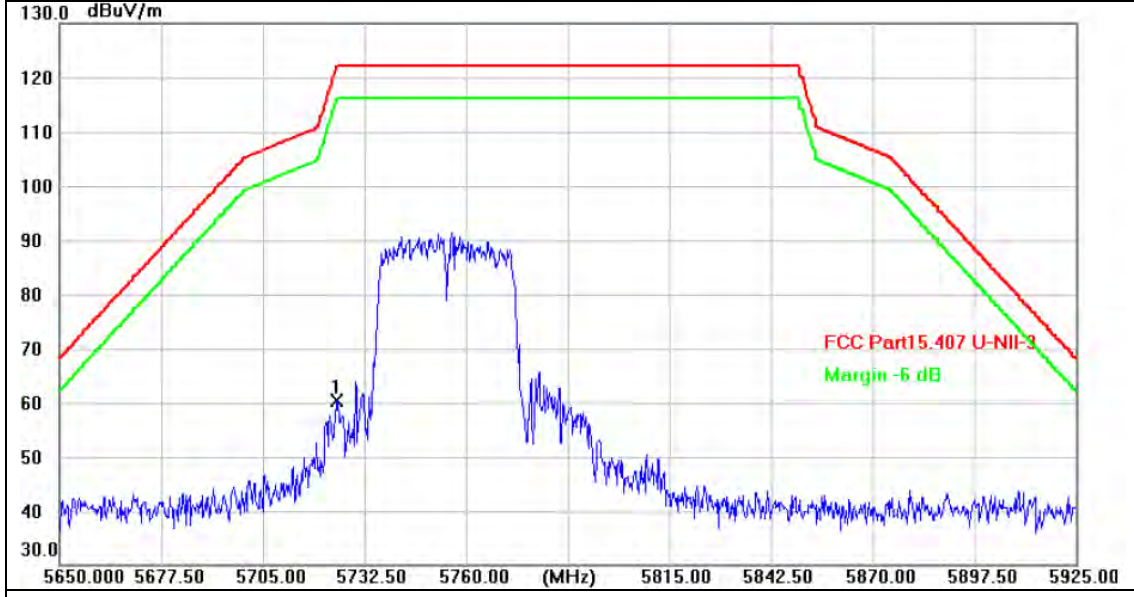

No.	Frequency (MHz)	Reading (dBuV)	Factor (dB/m)	Level (dBuV/m)	Limit (dBuV/m)	Margin (dB)	Detector
1 *	5725.000	55.91	4.54	60.45	122.20	-61.75	peak

Remarks:
 1. Factor (dB/m) = Antenna Factor (dB/m)+Cable Factor (dB)-Pre-amplifier Factor
 2. Margin value = Level -Limit value



Ant. Pol.:	Vertical
Test Mode:	TX 802.11ac(VHT40) Mode 5755MHz (U-NII-3)
Remark:	No report for the emission which more than 10 dB below the prescribed limit.

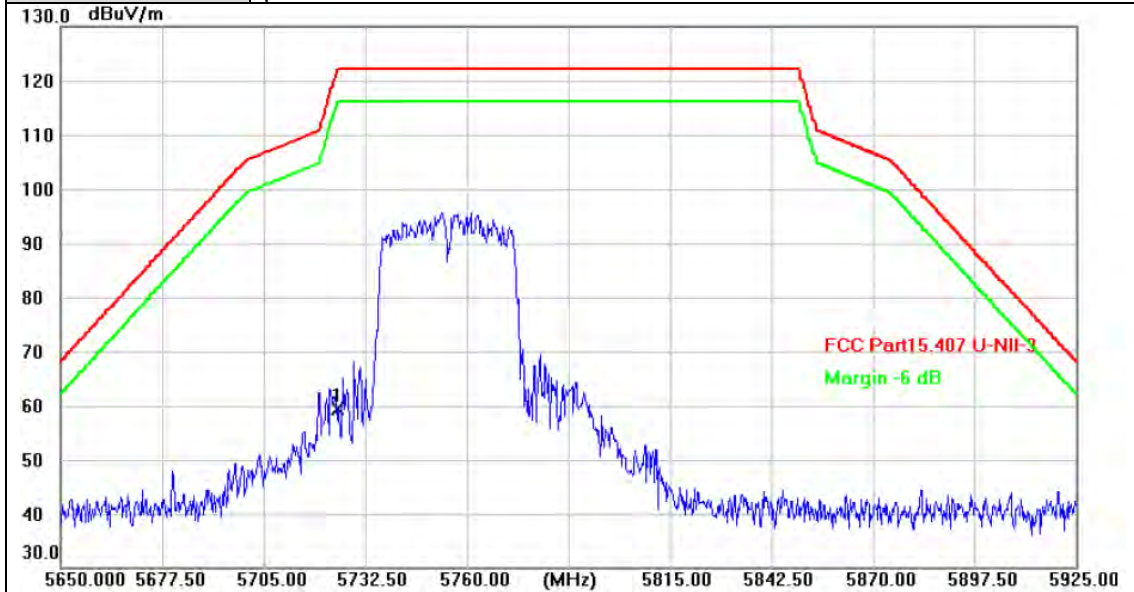

No.	Frequency (MHz)	Reading (dBuV)	Factor (dB/m)	Level (dBuV/m)	Limit (dBuV/m)	Margin (dB)	Detector
1 *	5725.000	54.96	4.54	59.50	122.20	-62.70	peak

Remarks:

- Factor (dB/m) = Antenna Factor (dB/m)+Cable Factor (dB)-Pre-amplifier Factor
- Margin value = Level -Limit value



Ant. Pol.:	Horizontal
Test Mode:	TX 802.11ac(VHT40) Mode 5795MHz (U-NII-3)
Remark:	No report for the emission which more than 10 dB below the prescribed limit.

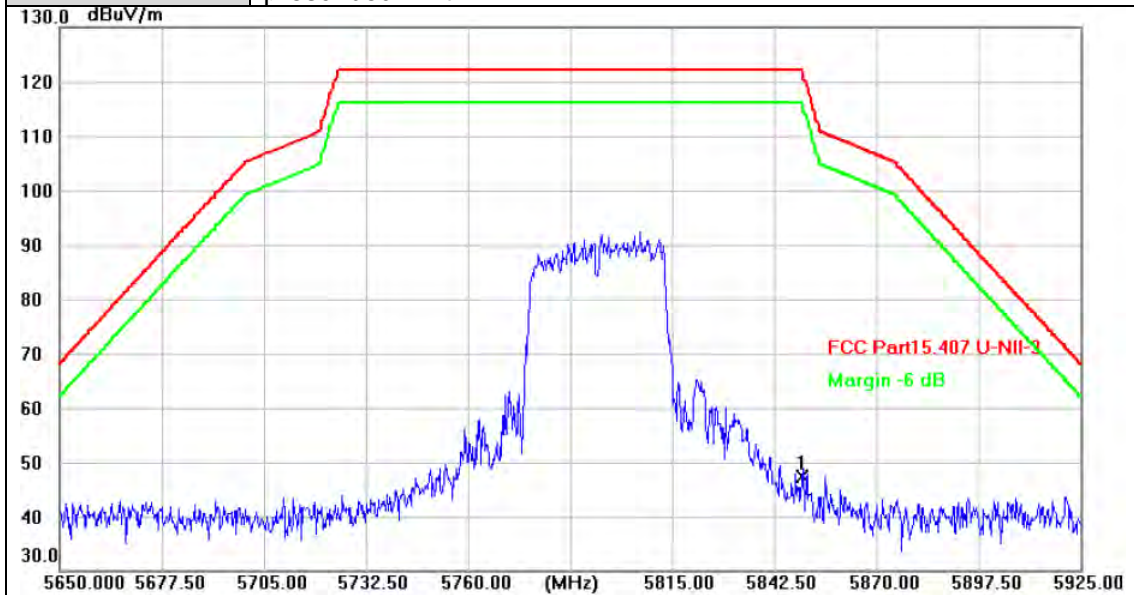

No.	Frequency (MHz)	Reading (dBuV)	Factor (dB/m)	Level (dBuV/m)	Limit (dBuV/m)	Margin (dB)	Detector
1 *	5850.000	42.37	4.95	47.32	122.20	-74.88	peak

Remarks:
 1. Factor (dB/m) = Antenna Factor (dB/m)+Cable Factor (dB)-Pre-amplifier Factor
 2. Margin value = Level -Limit value



Ant. Pol.:	Vertical
Test Mode:	TX 802.11ac(VHT40) Mode 5795MHz (U-NII-3)
Remark:	No report for the emission which more than 10 dB below the prescribed limit.

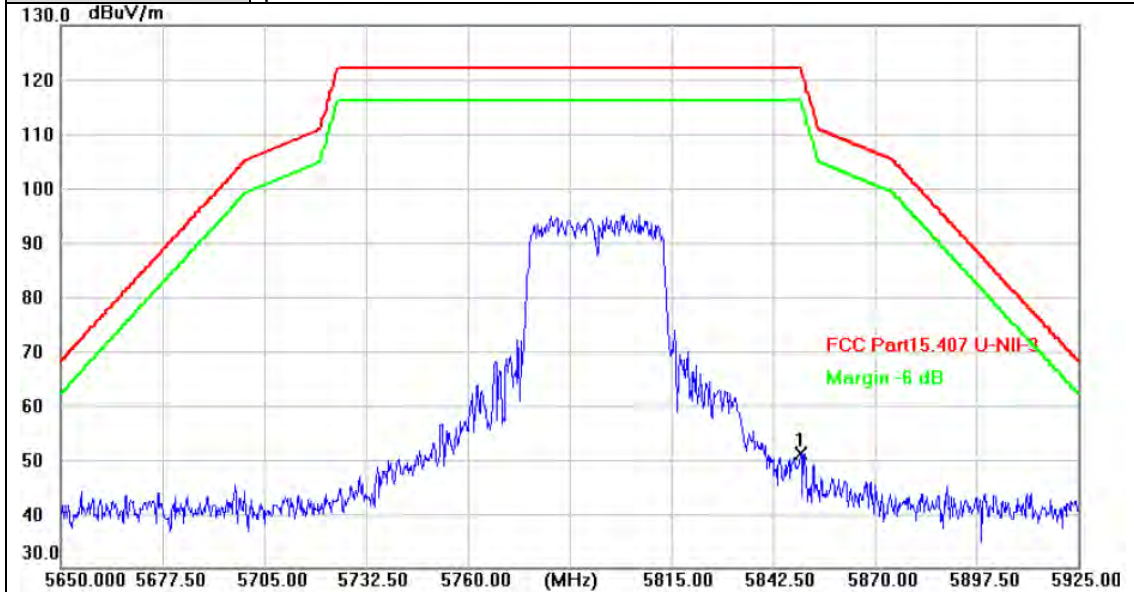

No.	Frequency (MHz)	Reading (dBuV)	Factor (dB/m)	Level (dBuV/m)	Limit (dBuV/m)	Margin (dB)	Detector
1 *	5850.000	46.18	4.95	51.13	122.20	-71.07	peak

Remarks:

- 1.Factor (dB/m) = Antenna Factor (dB/m)+Cable Factor (dB)-Pre-amplifier Factor
- 2.Margin value = Level -Limit value



Ant. Pol.:	Horizontal
Test Mode:	TX 802.11ac(VHT80) Mode 5775MHz (U-NII-3)
Remark:	No report for the emission which more than 10 dB below the prescribed limit.

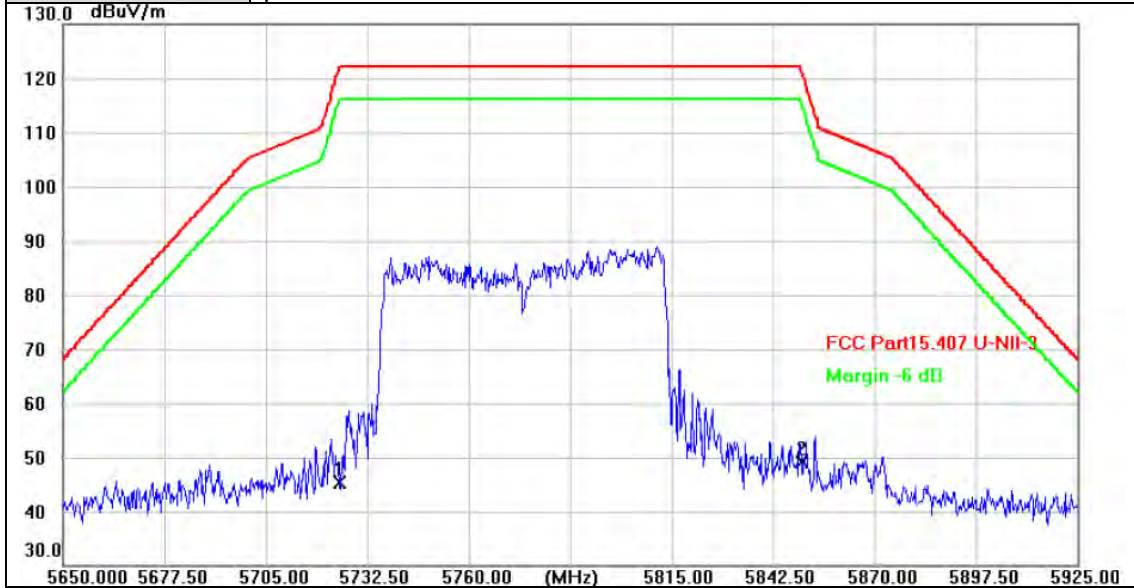

No.	Frequency (MHz)	Reading (dBuV)	Factor (dB/m)	Level (dBuV/m)	Limit (dBuV/m)	Margin (dB)	Detector
1	5725.000	40.95	4.54	45.49	122.20	-76.71	peak
2 *	5850.000	44.22	4.95	49.17	122.20	-73.03	peak

Remarks:

- Factor (dB/m) = Antenna Factor (dB/m)+Cable Factor (dB)-Pre-amplifier Factor
- Margin value = Level -Limit value

Ant. Pol.:	Vertical
Test Mode:	TX 802.11ac(VHT80) Mode 5775MHz (U-NII-3)
Remark:	No report for the emission which more than 10 dB below the prescribed limit.

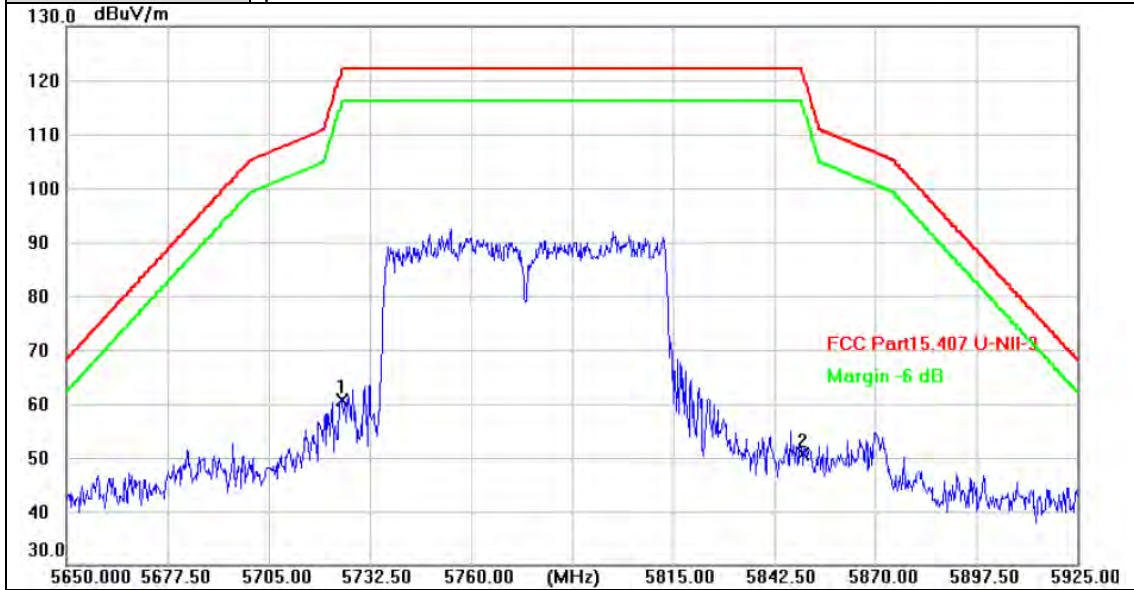

No.	Frequency (MHz)	Reading (dBuV)	Factor (dB/m)	Level (dBuV/m)	Limit (dBuV/m)	Margin (dB)	Detector
1 *	5725.000	56.15	4.54	60.69	122.20	-61.51	peak
2	5850.000	45.62	4.95	50.57	122.20	-71.63	peak

Remarks:

- 1.Factor (dB/m) = Antenna Factor (dB/m)+Cable Factor (dB)-Pre-amplifier Factor
- 2.Margin value = Level -Limit value

3.4. Bandwidth Test

Limit

FCC Part 15 Subpart C(15.407)/ RSS-247		
Test Item	Limit	Frequency Range (MHz)
26 Bandwidth	N/A	5150~5250
		5250~5350
		5500~5700
6 dB Bandwidth	>500kHz	5725~5850

Test Configuration

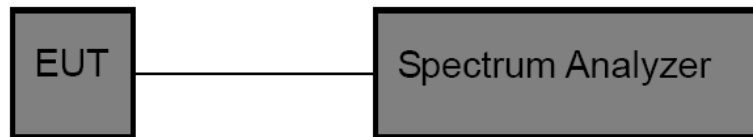

Test Procedure

Please refer to According to KDB789033 D02, for the measurement methods.

The setting of the spectrum analyser as below:

26dB Bandwidth Test	
Spectrum Parameters	Setting
Attenuation	Auto
Span	>26 dB Bandwidth
RBW	Approximately 1% of the emission bandwidth
VBW	VBW>RBW
Detector	Peak
Trace	Max Hold
Sweep Time	Auto



6dB Bandwidth Test	
Spectrum Parameters	Setting
Attenuation	Auto
Span	>6 dB Bandwidth
RBW	100 kHz
VBW	$VBW \geq 3 * RBW$
Detector	Peak
Trace	Max Hold
Sweep Time	Auto
99% Occupied Bandwidth Test	
Spectrum Parameters	Setting
Attenuation	Auto
RBW	1% to 5% of the OBW
VBW	$\geq 3RBW$
Detector	Peak
Trace	Max Hold

Note: The EUT was set to continuously transmitting in each mode and low, Middle and high channel for the test.

Test Mode

Please refer to the clause 2.4.

Test Results

Please see the Appendix A1, A2, A3.

3.5. Output Power Test

Limit

FCC Part 15 Subpart E (15.407)		
Test Item	Limit	Frequency Range(MHz)
Conducted Output Power	Fixed: 1 Watt (30dBm) Mobile and Portable: 250mW (24dBm)	5150~5250
	250mW (24dBm)	5250~5350
	250mW (24dBm)	5500~5700
	1 Watt (30dBm)	5725~5850

IC Power@PSD Limit					
Frequency	Type of devices	Maximum Conducted Output Power	EIRP Output Power	Conducted Power Spectral Density	EIRP Power Spectral Density
5150MHz-5250MHz	in vehicles		30mW or $1.76 + 10 \times \log_{10}B$ dBm, whichever is less (B=99% OBW in MHz)		
	Other Devices		200mW or $10 + 10 \times \log_{10}B$ dBm, whichever is less (B=99% OBW in MHz)		10dBm/MHz
5250MHz-5350MHz	in vehicles		30mW or $1.76 + 10 \times \log_{10}B$ dBm, whichever is less (B=99% OBW in MHz)		
	Other Devices	250mW or $11 + 10 \times \log_{10}B$ dBm, whichever is less (B=99% OBW in MHz)	1W or $17 + 10 \times \log_{10}B$ dBm, whichever is less (B=99% OBW in MHz)	11dBm/MHz	
5470MHz-5600MHz 5650MHz-5725MHz	ALL Devices	250mW or $11 + 10 \times \log_{10}B$ dBm, whichever is less (B=99% OBW in MHz)	1W or $17 + 10 \times \log_{10}B$ dBm, whichever is less (B=99% OBW in MHz)	11dBm/MHz	
5725MHz-5850MHz	ALL Devices	1W		30dBm/500KHz	

Test Configuration

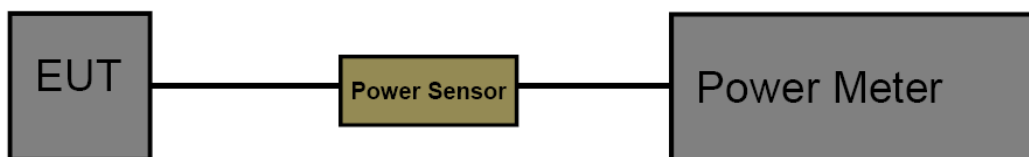



Test Procedure

The measurement is according to section 3 of KDB 789033 D02 General UNII Test Procedures New Rules V02r01.

Test Mode

Please refer to the clause 2.4.

Test Result

Please see the Appendix B.



3.6. Power Spectral Density Test

Limit

FCC Part 15 Subpart E(15.407)/ RSS-247

For the 5.15~5.25GHz band:

- Outdoor AP
The peak power spectral density (PSD) shall not exceed the lesser of 17dBm/MHz.
If $G_{TX} > 6\text{dBi}$, then $\text{PSD} = 17 - (G_{TX} - 6)$.
- Indoor AP
The peak power spectral density (PSD) shall not exceed the lesser of 17dBm/MHz.
If $G_{TX} > 6\text{dBi}$, then $\text{PSD} = 17 - (G_{TX} - 6)$.
- Point-to-point AP
The peak power spectral density (PSD) shall not exceed the lesser of 17dBm/MHz.
If $G_{TX} > 23\text{dBi}$, then $\text{PSD} = 17 - (G_{TX} - 23)$.
- Client devices
The peak power spectral density (PSD) shall not exceed the lesser of 11dBm/MHz.
If $G_{TX} > 6\text{dBi}$, then $\text{PSD} = 11 - (G_{TX} - 6)$.

For the 5.25~5.35GHz band:

The peak power spectral density (PSD) shall not exceed the lesser of 11dBm/MHz.
If $G_{TX} > 6\text{dBi}$, then $\text{PSD} = 11 - (G_{TX} - 6)$.

For the 5.47~5.725GHz band:

The peak power spectral density (PSD) shall not exceed the lesser of 11dBm/MHz.
If $G_{TX} > 6\text{dBi}$, then $\text{PSD} = 11 - (G_{TX} - 6)$.

For the 5.725~5.85GHz band:

- Point-to-multipoint systems (P2M)
The peak power spectral density (PSD) shall not exceed the lesser of 30dBm/500kHz.
If $G_{TX} > 6\text{dBi}$, then $\text{PSD} = 30 - (G_{TX} - 6)$.
- Point-to-point systems (P2P)
The peak power spectral density (PSD) shall not exceed the lesser of 30dBm/500kHz.

Note: G_{TX} : EUT Antenna gain.

IC Power&PSD Limit					
Frequency	Type of devices	Maximum Conducted Output Power	EIRP Output Power	Conducted Power Spectral Density	EIRP Power Spectral Density
5150MHz-5250MHz	in vehicles		30mW or $1.76 + 10 \times \log_{10} \text{B dBm}$, whichever is less (B=99% OBW in MHz)		
	Other Devices		200mW or $10 + 10 \times \log_{10} \text{B dBm}$, whichever is less (B=99% OBW in MHz)		10dBm/MHz
5250MHz-5350MHz	in vehicles		30mW or $1.76 + 10 \times \log_{10} \text{B dBm}$, whichever is less (B=99% OBW in MHz)		
	Other Devices	250mW or $11 + 10 \times \log_{10} \text{B dBm}$, whichever is less (B=99% OBW in MHz)	1W or $17 + 10 \times \log_{10} \text{B dBm}$, whichever is less (B=99% OBW in MHz)	11dBm/MHz	
5470MHz-5600MHz 5650MHz-5725MHz	ALL Devices	250mW or $11 + 10 \times \log_{10} \text{B dBm}$, whichever is less (B=99% OBW in MHz)	1W or $17 + 10 \times \log_{10} \text{B dBm}$, whichever is less (B=99% OBW in MHz)	11dBm/MHz	
5725MHz-5850MHz	ALL Devices	1W		30dBm/500KHz	

CTC Laboratories, Inc.

1-2/F., Building 2, Jiaquan Building, Guanlan High-Tech Park, Shenzhen, Guangdong, China

Tel.: (86)755-27521059

Fax: (86)755-27521011

Http://www.sz-ctc.org.cn



For anti-fake verification, please visit the official website of Certification and Accreditation Administration of the People's Republic of China : yz.cnca.cn

Test Configuration

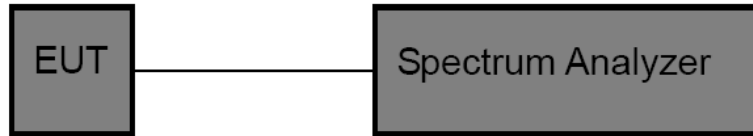

Test Procedure

The EUT was directly connected to the Spectrum Analyzer and antenna output port as show in the block diagram above. The measurement is according to KDB 789033 D02 General UNII Test Procedures New Rules V02r01.

- (1) The EUT was directly connected to the spectrum analyzer and antenna output port as show in the block diagram above.
- (2) Set analyzer center frequency to transmitting frequency.
- (3) Set the span to encompass the entire emissions bandwidth (EBW)(alternatively, the entire 99% OBW) of the signal.
- (4) RBW=1MHz for devices operating in the bands 5.15-5.25 GHz, 5.25-5.35 GHz, and 5.47-5.725 GHz
RBW=500kHz for devices operating in the band 5.725-5.85 GHz
- (5) Set the VBW to: ≥ 3 RBW
- (6) Detector: AVG
- (7) Trace: Max Hold and View
- (7) Sweep time: auto
- (8) Trace average at least 100 traces in power averaging.
- (9) User the peak marker function to determine the maximum amplitude level within the RBW. Apply correction to the result if different RBW is used.

NOTE: The EUT was set to continuously transmitting in each mode and low, Middle and high channel for the test.

Test Mode

Please refer to the clause 2.4.

Test Result

Please see the Appendix C.

3.7. Frequency Stability Measurement

Limit

FCC Part 15 Subpart C(15.407)		
Test Item	Limit	Frequency Range(MHz)
Peak Excursion Measurement	Specified in the user's manual, the transmitter center frequency tolerance shall be ± 20 ppm maximum for the 5 GHz band (IEEE 802.11n specification)	5150~5250
		5250~5350
		5500~5700
		5725~5850

Test Configuration

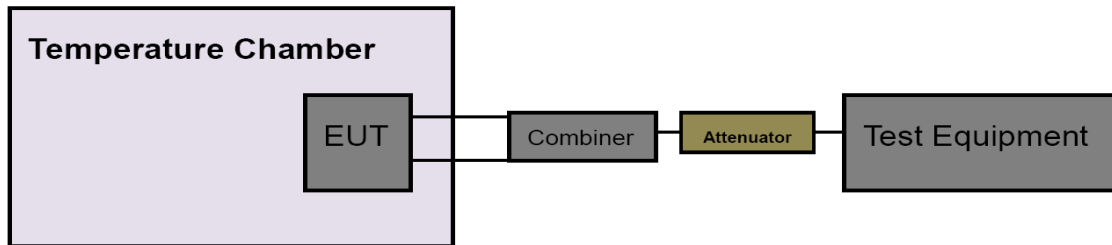

Test Procedure

The EUT was directly connected to the Spectrum Analyzer and antenna output port as show in the block diagram above.

- (1) The EUT was directly connected to the spectrum analyzer and antenna output port as show in the block diagram above.
- (2) Set analyzer center frequency to transmitting frequency.
- (3) Set the span to encompass the entire emissions bandwidth (EBW) of the signal.
- (4) Set the RBW to: 10MHz, VBW=10MHz with peak detector and maxhold settings.
- (5) The test extreme voltage is to change the primary supply voltage from 6.66V to 8.14V percent of the nominal value.
- (6) Extreme temperature is 0°C~50°C

NOTE: The EUT was set to continuously transmitting in continuously un-modulation transmitting mode.

Test Mode

Please refer to the clause 2.4.

Test Result

Please see the Appendix D.



3.8. Antenna Requirement

Standard Requirement

FCC CFR Title 47 Part 15 Subpart C Section 15.203:

An intentional radiator shall be designed to ensure that no antenna other than that furnished by the responsible party shall be used with the device. The use of a permanently attached antenna or of an antenna that uses a unique coupling to the intentional radiator, the manufacturer may design the unit so that a broken antenna can be replaced by the user, but the use of a standard antenna jack or electrical connector is prohibited.

Test Result

The directional gain of the antenna less than 6dBi, please refer to the EUT internal photographs antenna photo.



3.9. Dynamic Frequency Selection(DFS)

Requirement

Table 1: Applicability of DFS Requirements Prior to Use of a Channel

Requirement	Operational Mode		
	Master	Client Without Radar Detection	Client With Radar Detection
Non-Occupancy Period	Yes	Not required	Yes
DFS Detection Threshold	Yes	Not required	Yes
Channel Availability Check Time	Yes	Not required	Not required
U-NII Detection Bandwidth	Yes	Not required	Yes

Table 2: Applicability of DFS requirements during normal operation

Requirement	Operational Mode	
	Master Device or Client with Radar Detection	Client Without Radar Detection
DFS Detection Threshold	Yes	Not required
Channel Closing Transmission Time	Yes	Yes
Channel Move Time	Yes	Yes
U-NII Detection Bandwidth	Yes	Not required

Additional requirements for devices with multiple bandwidth modes	Master Device or Client with Radar Detection	Client Without Radar Detection
U-NII Detection Bandwidth and Statistical Performance Check	All BW modes must be tested	Not required
Channel Move Time and Channel Closing Transmission Time	Test using widest BW mode available	Test using the widest BW mode available for the link
All other tests	Any single BW mode	Not required

Note: Frequencies selected for statistical performance check (Section 7.8.4) should include several frequencies within the radar detection bandwidth and frequencies near the edge of the radar detection bandwidth. For 802.11 devices it is suggested to select frequencies in each of the bonded 20 MHz channels and the channel center frequency.

**LIMIT**

1. DFS Detection Thresholds

Table 3: DFS Detection Thresholds for Master Devices and Client Devices With Radar Detection

Maximum Transmit Power	Value (See Notes 1, 2, and 3)
EIRP \geq 200 milliwatt	-64 dBm
EIRP < 200 milliwatt and power spectral density < 10 dBm/MHz	-62 dBm
EIRP < 200 milliwatt that do not meet the power spectral density requirement	-64 dBm

Note 1: This is the level at the input of the receiver assuming a 0dBi receive antenna.
Note 2: Throughout these test procedures an additional 1 dB has been added to the amplitude of the test transmission waveforms to account for variations in measurement equipment. This will ensure that the test signal is at or above the detection threshold level to trigger a DFS response.
Note3: EIRP is based on the highest antenna gain. For MIMO devices refer to KDB Publication 662911 D01.

2. DFS Response Requirements

Table 4: DFS Response Requirement Values

Parameter	Value
Non-occupancy period	Minimum 30 minutes
Channel Availability Check Time	60 seconds
Channel Move Time	10 seconds See Note 1.
Channel Closing Transmission Time	200 milliseconds + an aggregate of 60 milliseconds over remaining 10 second period. See Notes 1 and 2.
U-NII Detection Bandwidth	Minimum 100% of the U-NII 99% transmission power bandwidth. See Note 3.

Note 1: Channel Move Time and the Channel Closing Transmission Time should be performed with Radar Type 0. The measurement timing begins at the end of the Radar Type 0 burst.
Note 2: The Channel Closing Transmission Time is comprised of 200 milliseconds starting at the beginning of the Channel Move Time plus any additional intermittent control signals required facilitating a Channel move (an aggregate of 60 milliseconds) during the remainder of the 10 second period. The aggregate duration of control signals will not count quiet periods in between transmissions.
Note 3: During the U-NII Detection Bandwidth detection test, radar type 0 should be used. For each frequency step the minimum percentage of detection is 90 percent. Measurements are performed with no data traffic.

RADAR TEST WAVEFORMS

This section provides the parameters for required test waveforms, minimum percentage of successful detections, and the minimum number of trials that must be used for determining DFS conformance. Step intervals of 0.1 microsecond for Pulse Width, 1 microsecond for PRI, 1 MHz for chirp width and 1 for the number of pulses will be utilized for the random determination of specific test waveforms.



Table 5 Short Pulse Radar Test Waveforms

Radar Type	Pulse Width (μsec)	PRI (μsec)	Number of Pulses	Minimum Percentage of Successful Detection	Minimum Number of Trials
0	1	1428	18	See Note 1	See Note 1
1	1	Test A: 15 unique PRI values randomly selected from the list of 23 PRI values in Table 5a	$\text{Roundup} \left\{ \left(\frac{1}{360} \right) \cdot \left(\frac{19 \cdot 10^6}{\text{PRI}_{\mu\text{SEC}}} \right) \right\}$	60%	30
		Test B: 15 unique PRI values randomly selected within the range of 518-3066 μsec, with a minimum increment of 1 μsec, excluding PRI values selected in Test A			
2	1-5	150-230	23-29	60%	30
3	6-10	200-500	16-18	60%	30
4	11-20	200-500	12-16	60%	30
Aggregate (Radar Types 1-4)				80%	120
Note 1: Short Pulse Radar Type 0 should be used for the detection bandwidth test, channel move time, and channel closing time tests.					

A minimum of 30 unique waveforms are required for each of the Short Pulse Radar Types 2 through 4. If more than 30 waveforms are used for Short Pulse Radar Types 2 through 4, then each additional waveform must also be unique and not repeated from the previous waveforms. If more than 30 waveforms are used for Short Pulse Radar Type 1, then each additional waveform is generated with Test B and must also be unique and not repeated from the previous waveforms in Tests A or B.

For example if in Short Pulse Radar Type 1 Test B a PRI of 3066 μsec is selected, the number of pulses

$$\left\{ \left(\frac{1}{360} \right) \cdot \left(\frac{19 \cdot 10^6}{3066} \right) \right\}$$

would be Round up {17.2} = Round up {17.2} = 18.

Table 5a - Pulse Repetition Intervals Values for Test A

Pulse Repetition Frequency Number	Pulse Repetition Frequency (Pulses Per Second)	Pulse Repetition Interval (Microseconds)
1	1930.5	518
2	1858.7	538
3	1792.1	558
4	1730.1	578
5	1672.2	598
6	1618.1	618
7	1567.4	638
8	1519.8	658
9	1474.9	678
10	1432.7	698

CTC Laboratories, Inc.

1-2/F., Building 2, Jiaquan Building, Guanlan High-Tech Park, Shenzhen, Guangdong, China

Tel.: (86)755-27521059

Fax: (86)755-27521011

Http://www.sz-ctc.org.cn



For anti-fake verification, please visit the official website of Certification and Accreditation Administration of the People's Republic of China : yz.cnca.cn



11	1392.8	718
12	1355	738
13	1319.3	758
14	1285.3	778
15	1253.1	798
16	1222.5	818
17	1193.3	838
18	1165.6	858
19	1139	878
20	1113.6	898
21	1089.3	918
22	1066.1	938
23	326.2	3066

Table 6 – Long Pulse Radar Test Waveform

Radar Type	Pulse Width (μsec)	Chirp Width (MHz)	PRI (μsec)	Number of Pulses per Burst	Number of Bursts	Minimum Percentage of Successful Detection	Minimum Number of Trials
5	50-100	5-20	1000-2000	1-3	8-20	80%	30

The parameters for this waveforms are randomly chosen. Thirty unique waveforms are required for the Long Pulse Radar Type waveforms. If more than 30 waveforms are used for the Long Pulse Radar Type wave forms, then each additional waveform must also be unique and not repeated from the previous waveforms.

Table 7 – Frequency Hopping Radar Test Waveform

Radar Type	Pulse Width (μsec)	PRI (μsec)	Pulses per Hop	Hopping Rate (kHz)	Hopping Sequence Length (msec)	Minimum Percentage of Successful Detection	Minimum Number of Trials
6	1	333	9	0.333	300	70%	30

For the Frequency Hopping Radar Type, the same Burst parameters are used for each wave form. The hopping sequence is different for each wave form and a 100-length segment is selected from the hopping sequence defined by the following algorithm:

The first frequency in a hopping sequence is selected randomly from the group of 475 integer frequencies from 5250–5724MHz. Next, the frequency that was just chosen is removed from the group and a frequency is randomly selected from the remaining 474 frequencies in the group. This process continues until all 475 frequencies are chosen for the set. For selection of a random frequency, the frequencies remaining within the group are always treated as equally likely.

Calibration of Radar Waveform

Radar Waveform Calibration Procedure

- 1) A 50 ohm load is connected in place of the spectrum analyzer, and the spectrum analyzer is connected to place of the master
- 2) The interference Radar Detection Threshold Level is $-62\text{dBm} + 0\text{dBi} + 1\text{dB} = -61\text{dBm}$ that had been taken into account the output power range and antenna gain.
- 3) The following equipment setup was used to calibrate the conducted radar waveform. A vector signal generator was utilized to establish the test signal level for radar type 0. During this process there were no transmissions by either the master or client device. The spectrum analyzer was switched to the zero spans (time domain) at the frequency of the radar waveform generator. Peak detection was

used. The spectrum analyzer resolution bandwidth (RBW) and video bandwidth (VBW) were set to 3 MHz. The spectrum analyzer had offset -1.0dB to compensate RF cable loss 1.0dB.

- 4) The vector signal generator amplitude was set so that the power level measured at the spectrum analyzer was $-62\text{dBm} + 0\text{dBi} + 1\text{dB} = -61\text{dBm}$. Capture the spectrum analyzer plots on short pulse radar waveform.

Conducted Calibration Setup

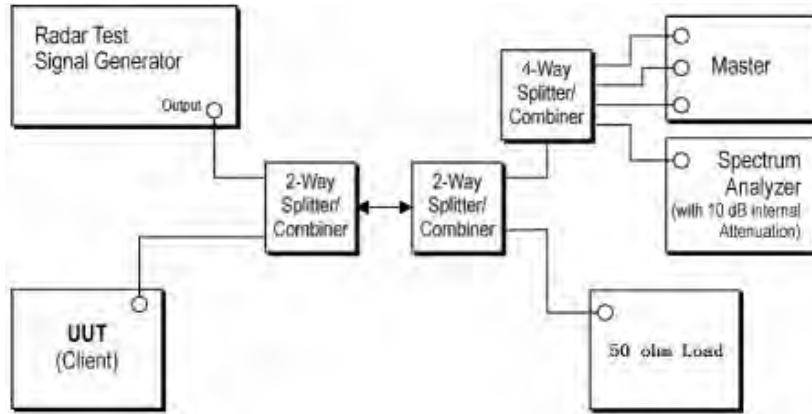

Test Configuration

Setup for Client with injection at the Master

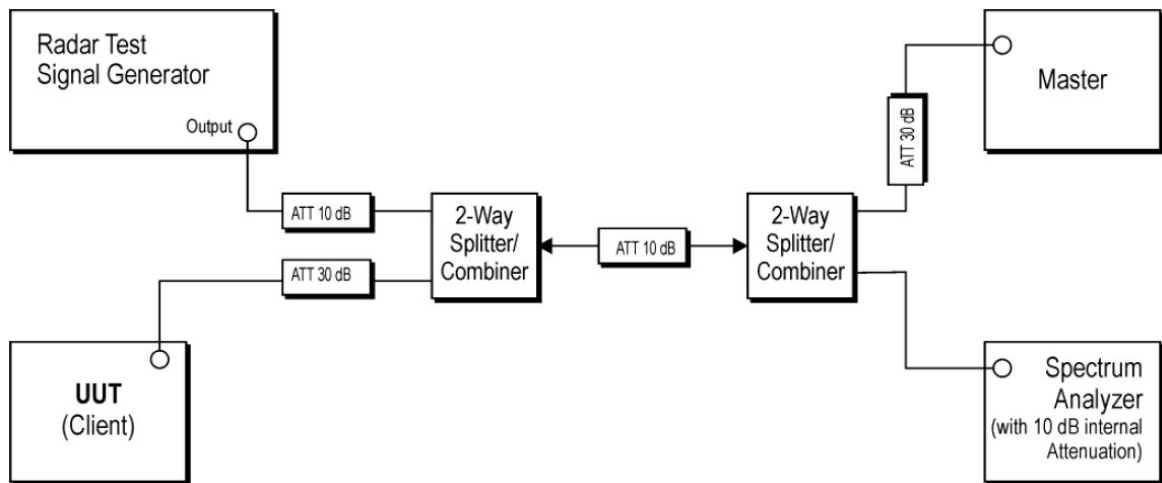

Radars Waveform Calibration Result

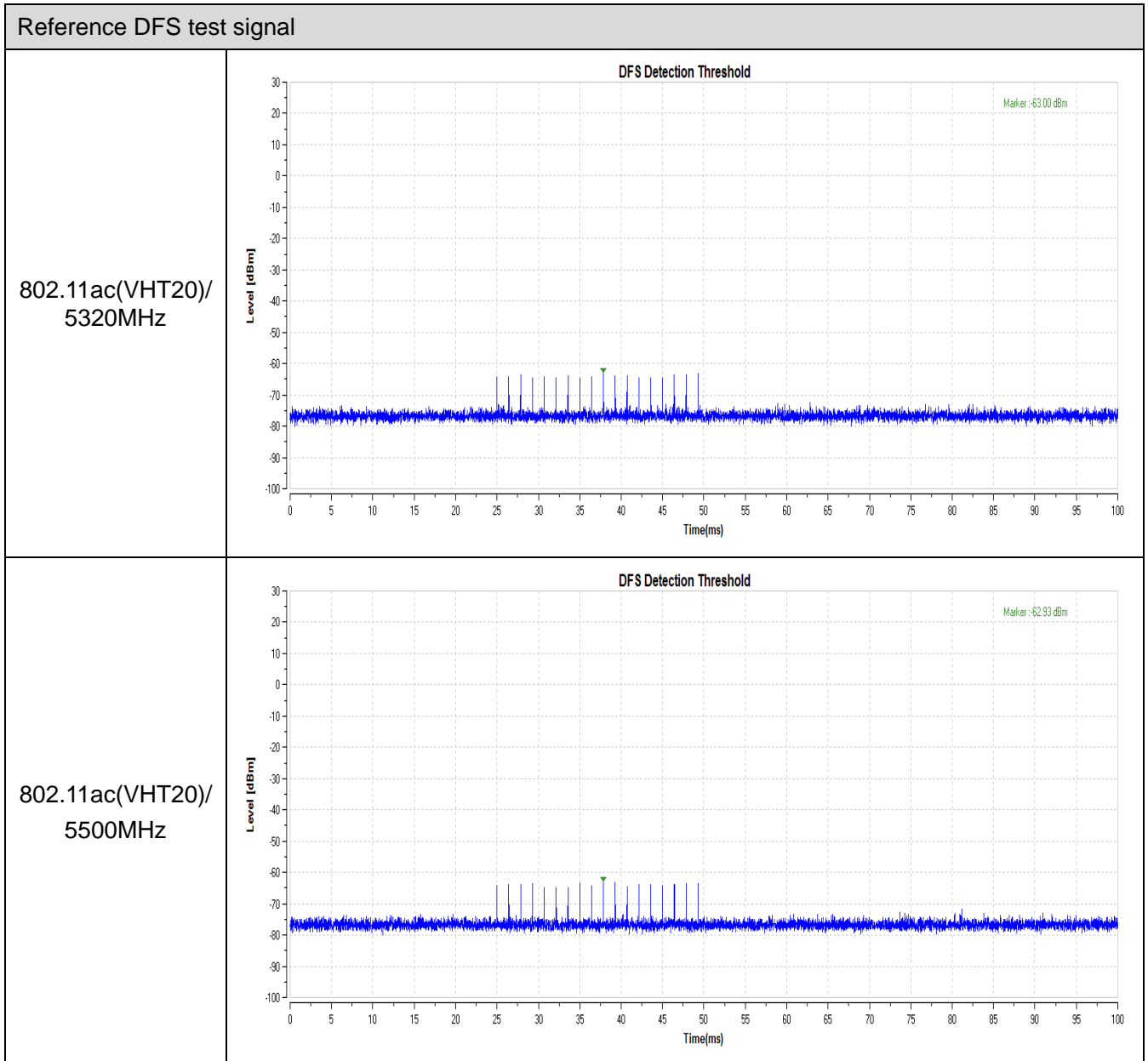

Test Procedure

1. The radar pulse generator is setup to provide a pulse at frequency that the master and client are operating. A type 0 radar pulse with a 1us pulse width and a 1428us PRI is used for the testing.
2. The vector signal generator is adjusted to provide the radar burst (18 pulses) at the level of approximately -61dBm at the antenna port of the master device
3. A trigger is provided from the pulse generator to the DFS monitoring system in order to capture the traffic and the occurrence of the radar pulse.
4. EUT will associate with the master at channel. The file "iperf.exe" specified by the FCC is streamed from the PC 2 through the master and the client device to the PC 1 and played in full motion video using Media Player Classic Ver. 6.4.8.6 in order to properly load the network for the entire period of the test.
5. When radar burst with a level equal to the DFS Detection Threshold +1dB is generated on the operating channel of the U-NII device. At time T0 the radar waveform generator sends a burst of pulse of the radar waveform at Detection Threshold +1dB.



6. Observe the transmissions of the EUT at the end of the radar Burst on the Operating Channel Measure and record the transmissions from the UUT during the observation time (Channel Move Time). One 15 seconds plot is reported for the Short Pulse Radar Type 0. The plot for the Short Pulse Radar Types start at the end of the radar burst. The Channel Move Time will be calculated based on the zoom in 600ms plot of the Short Pulse Radar Type
7. Measurement of the aggregate duration of the Channel Closed Transmission Time method. With the spectrum analyzer set to zero span tuned to the center frequency of the EUT operating channel at the radar simulated frequency, peak detection, and max hold, the dwell time per bin is given by: $Dwell (0.3ms) = S (12000ms) / B (4000)$; where Dwell is the dwell time per spectrum analyzer sampling bin, S is sweep time and B is the number of spectrum analyzer sampling bins. An upper bound of the aggregate duration of the intermittent control signals of Channel Closing Transmission Time is calculated by: $C (ms) = N \times Dwell (0.3ms)$; where C is the Closing Time, N is the number of spectrum analyzer sampling bins (intermittent control signals) showing a U-NII transmission and Dwell is the dwell time per bin.
8. Measurement the EUT for more than 30 minutes following the channel move time to verify that no transmission or beacons occur on this channel.

Test Mode

Please refer to the clause 2.4.

Test Results
 Passed **Not Applicable**

BW/Channel	Test Item	Test Result	Limit	Result
802.11ac(VHT20)/ 5320MHz	Channel Move Time	1078.92ms	< 10s	Pass
	Channel Closing Transmission Time	98.82ms	< 200+60ms	Pass
	Non-Occupancy Period	See test graph	>=1800	Pass
802.11ac(VHT20)/ 5500MHz	Channel Move Time	1070.82ms	< 10s	Pass
	Channel Closing Transmission Time	59.94ms	< 200+60ms	Pass
	Non-Occupancy Period	See test graph	>=1800	Pass

Channel Move Time & Channel Closing Transmission Time

802.11ac(VHT20)/
5320MHz

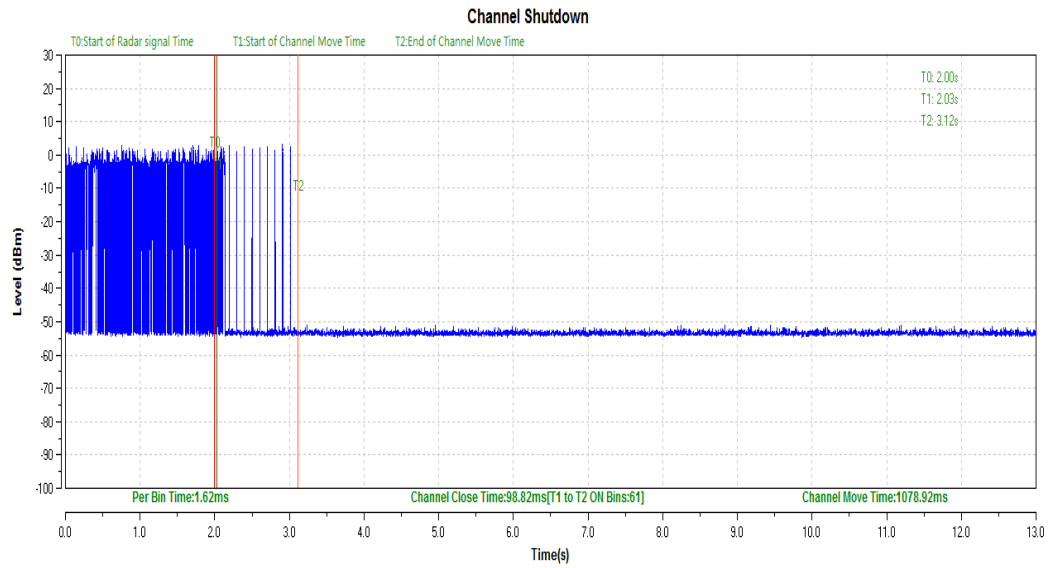

802.11ac(VHT20)/
5500MHz

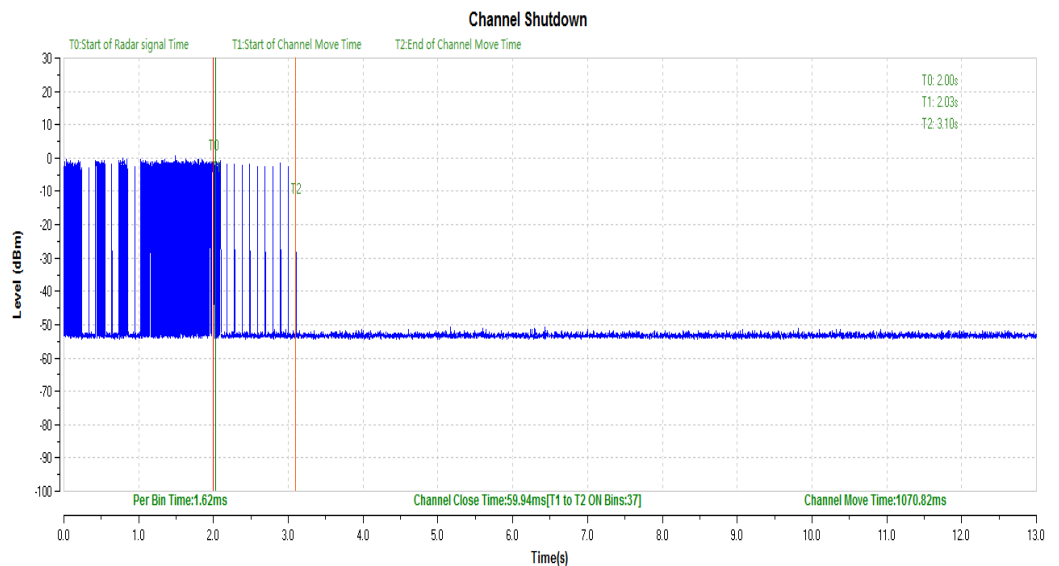

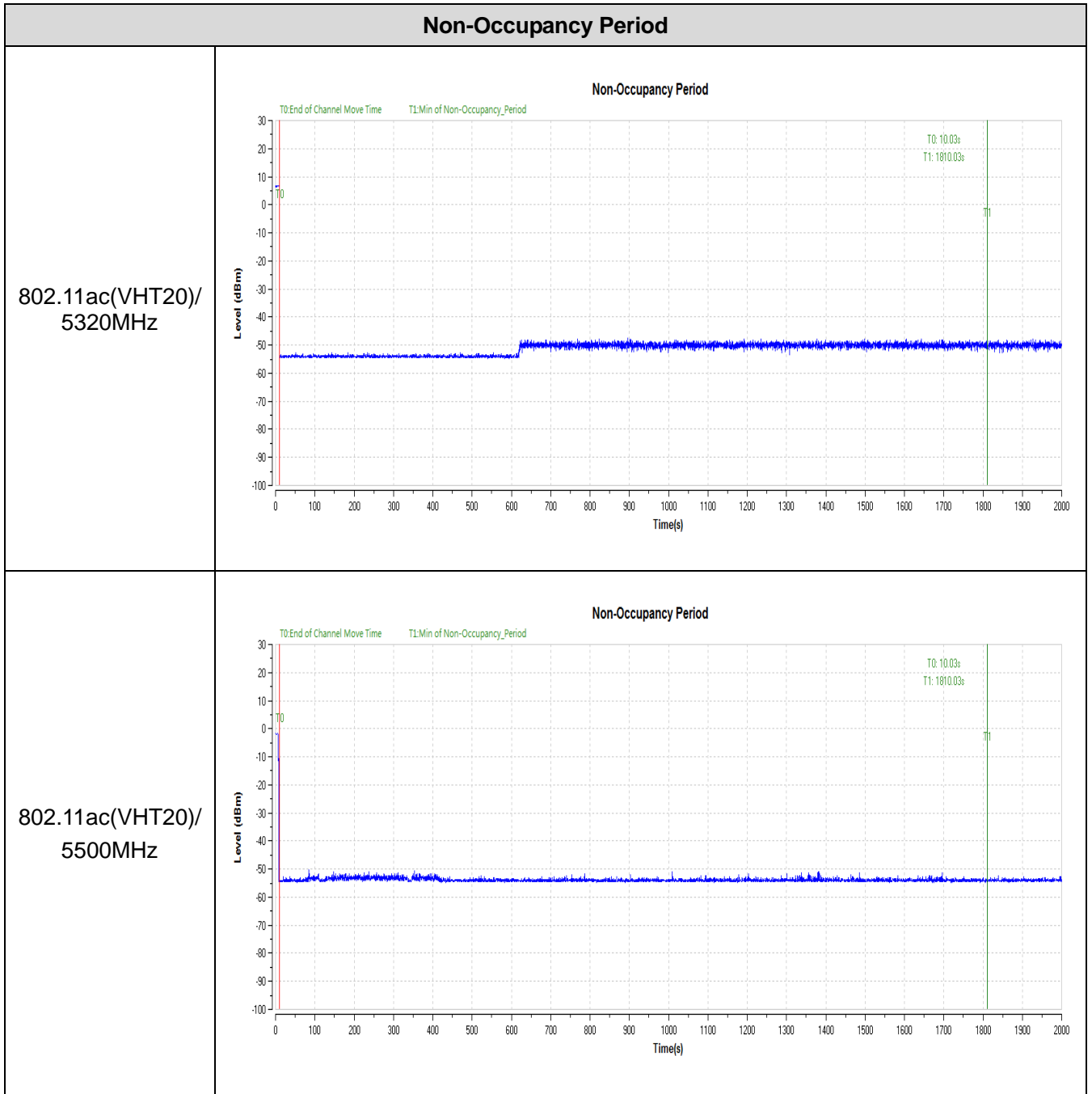

*****THE END*****