



CTC Laboratories, Inc.

1-2/F., Building 2, Jiaquan Building, Guanlan High-Tech Park, Shenzhen, Guangdong, China
Tel: +86-755- 27521059 Fax: +86-755- 27521011 Http://www.sz-ctc.org.cn

TEST REPORT

Report No.: **CTC20211260E04**

FCC ID.....: **2AYD5-I21M02**

Applicant.....: **Imin Technology Pte Ltd**

Address.....: 11 Bishan Street 21, #03-05 Bosch Building, Singapore 573943

Manufacturer.....: Imin Technology Pte Ltd

Address.....: 11 Bishan Street 21, #03-05 Bosch Building, Singapore 573943

Product Name.....: **Mobile POS**

Trade Mark.....: iMin

Model/Type reference.....: I21M02

Listed Model(s): N/A

Standard.....: **FCC CFR Title 47 Part 15 Subpart C Section 15.247**

Date of receipt of test sample...: Jul. 20, 2021

Date of testing.....: Jul. 21, 2021 ~ Aug. 11, 2021

Date of issue.....: Aug. 26, 2021

Result.....: **PASS**

Compiled by:		
(Printed name+signature)	Terry Su	
Supervised by:		
(Printed name+signature)	Miller Ma	
Approved by:		
(Printed name+signature)	Walter Chen	

Testing Laboratory Name.....: **CTC Laboratories, Inc.**

Address.....: 1-2/F., Building 2, Jiaquan Building, Guanlan High-Tech Park, Shenzhen, Guangdong, China

This test report may be duplicated completely for legal use with the approval of the applicant. It should not be reproduced except in full, without the written approval of our laboratory. The client should not use it to claim product endorsement by CTC. The test results in the report only apply to the tested sample. The test report shall be invalid without all the signatures of testing engineers, reviewer and approver. Any objections must be raised to CTC within 15 days since the date when the report is received. It will not be taken into consideration beyond this limit. The test report merely correspond to the test sample.



Table of Contents

Page

1. TEST SUMMARY..... 3

1.1. TEST STANDARDS.....3

1.2. REPORT VERSION.....3

1.3. TEST DESCRIPTION.....4

1.4. TEST FACILITY5

1.5. MEASUREMENT UNCERTAINTY5

1.6. ENVIRONMENTAL CONDITIONS6

2. GENERAL INFORMATION..... 7

2.1. CLIENT INFORMATION7

2.2. GENERAL DESCRIPTION OF EUT8

2.3. ACCESSORY EQUIPMENT INFORMATION9

2.4. OPERATION STATE.....10

2.5. MEASUREMENT INSTRUMENTS LIST11

3. TEST ITEM AND RESULTS 13

3.1. CONDUCTED EMISSION.....13

3.2. RADIATED EMISSION16

3.3. BAND EDGE EMISSIONS (RADIATED)44

3.4. BAND EDGE AND SPURIOUS EMISSIONS (CONDUCTED)61

3.5. DTS BANDWIDTH.....79

3.6. PEAK OUTPUT POWER85

3.7. POWER SPECTRAL DENSITY87

3.8. DUTY CYCLE93

3.9. ANTENNA REQUIREMENT99



1. TEST SUMMARY

1.1. Test Standards

The tests were performed according to following standards:

[FCC Rules Part 15.247](#): Operation within the bands of 902-928MHz, 2400-2483.5MHz, and 5725-5850MHz.

[RSS 247 Issue 2](#): Standard Specifications for Frequency Hopping Systems (FHSs) and Digital Transmission Systems (DTSS) Operating in the Bands 902-928MHz, 2400-2483.5MHz and 5725-5850MHz.

[ANSI C63.10-2013](#): American National Standard for Testing Unlicensed Wireless Devices.

1.2. Report version

Revised No.	Date of issue	Description
01	Aug. 12, 2021	Original
02	Aug. 23, 2021	Update application, manufacturer address
03	Aug. 26, 2021	Increase the trademark



1.3. Test Description

FCC Part 15 Subpart C (15.247) / RSS 247 Issue 2				
Test Item	Standard Section		Result	Test Engineer
	FCC	IC		
Antenna Requirement	15.203	/	Pass	Alicia Liu
Conducted Emission	15.207	RSS-Gen 8.8	Pass	Jojo He
Radiated Band Edge and Spurious Emissions	15.205&15.209&15.247(d)	RSS 247 5.5	Pass	Alicia Liu
Conducted Band Edge and Spurious Emissions	15.247(d)	RSS 247 5.5	Pass	Alicia Liu
6dB Bandwidth	15.247(a)(2)	RSS 247 5.2 (a)	Pass	Alicia Liu
Conducted Max Output Power	15.247(b)(3)	RSS 247 5.4 (d)	Pass	Alicia Liu
Power Spectral Density	15.247(e)	RSS 247 5.2 (b)	Pass	Alicia Liu
Transmitter Radiated Spurious	15.209&15.247(d)	RSS 247 5.5&RSS-Gen 8.9	Pass	Alicia Liu

Note: The measurement uncertainty is not included in the test result.



1.4. Test Facility

CTC Laboratories, Inc.

Add: 1-2/F., Building 2, Jiaquan Building, Guanlan High-Tech Park, Shenzhen, Guangdong, China

Laboratory accreditation

The test facility is recognized, certified, or accredited by the following organizations:

CNAS-Lab Code: L5365

CTC Laboratories, Inc. has been assessed and proved to be in compliance with CNAS-CL01 Accreditation. Criteria for Testing and Calibration Laboratories (identical to ISO/IEC 17025:2017 General Requirements) for the Competence of Testing and Calibration Laboratories.

A2LA-Lab Cert. No.: 4340.01

CTC Laboratories, Inc. EMC Laboratory has been accredited by A2LA for technical competence in the field of electrical testing, and proved to be in compliance with ISO/IEC 17025:2017 General Requirements for the Competence of Testing and Calibration Laboratories and any additional program requirements in the identified field of testing.

Industry Canada (Registration No.: 9783A, CAB Identifier: CN0029)

CTC Laboratories, Inc. EMC Laboratory has been registered by Certification and Engineer Bureau of Industry Canada for the performance of with Registration NO.: 9783A on Jan, 2016.

FCC (Registration No.: 951311, Designation Number CN1208)

CTC Laboratories, Inc. EMC Laboratory has been registered and fully described in a report filed with the (FCC) Federal Communications Commission. The acceptance letter from the FCC is maintained in our files. Registration 951311, Aug 26, 2017.

1.5. Measurement Uncertainty

The data and results referenced in this document are true and accurate. The reader is cautioned that there may be errors within the calibration limits of the equipment and facilities. The measurement uncertainty was calculated for all measurements listed in this test report acc. to TR-100028-01 "Electromagnetic compatibility and Radio spectrum Matters (ERM); Uncertainties in the measurement of mobile radio equipment characteristics; Part 1" and TR-100028-02 "Electromagnetic compatibility and Radio spectrum Matters (ERM); Uncertainties in the measurement of mobile radio equipment characteristics; Part 2" and is documented in the CTC Laboratories, Inc. quality system acc. to DIN EN ISO/IEC 17025. Furthermore, component and process variability of devices similar to that tested may result in additional deviation. The manufacturer has the sole responsibility of continued compliance of the device.

Below is the best measurement capability for CTC Laboratories, Inc.



Test Items	Measurement Uncertainty	Notes
Transmitter power conducted	0.42 dB	(1)
Transmitter power Radiated	2.14 dB	(1)
Conducted spurious emissions 9kHz~40GHz	1.60 dB	(1)
Radiated spurious emissions 9kHz~40GHz	2.20 dB	(1)
Conducted Emissions 9kHz~30MHz	3.08 dB	(1)
Radiated Emissions 30~1000MHz	4.51 dB	(1)
Radiated Emissions 1~18GHz	5.84 dB	(1)
Radiated Emissions 18~40GHz	6.12 dB	(1)
Occupied Bandwidth	-----	(1)

Note (1): This uncertainty represents an expanded uncertainty expressed at approximately the 95% confidence level using a coverage factor of $k=1.96$.

1.6. Environmental conditions

During the measurement the environmental conditions were within the listed ranges:

Temperature:	21°C ~ 27°C
Relative Humidity:	40% ~ 60%
Air Pressure:	101kPa



2. GENERAL INFORMATION

2.1. Client Information

Applicant:	Imin Technology Pte Ltd
Address:	11 Bishan Street 21, #03-05 Bosch Building, Singapore 573943
Manufacturer:	Imin Technology Pte Ltd
Address:	11 Bishan Street 21, #03-05 Bosch Building, Singapore 573943



2.2. General Description of EUT

Product Name:	Mobile POS
Trade Mark:	iMin
Model/Type reference:	I21M02
Listed Model(s):	N/A
Power supply:	5Vdc/2A from AC/DC Adapter 7.4Vdc from 2600mAh Li-ion Battery
Adapter model:	TPA-46050200UU Input: 100-240V~ 50/60Hz 0.3A Output: 5Vdc/2A
Hardware version:	N/A
Software version:	N/A
WIFI 802.11b/ g/ n(HT20)/ n(HT40)	
Modulation:	802.11b: DSSS(CCK, DQPSK, DBPSK) 802.11g/n: OFDM(BPSK, QPSK, 16QAM, 64QAM)
Operation frequency:	802.11b/g/n(HT20): 2412MHz~2462MHz 802.11n(HT40): 2422MHz~2452MHz
Channel number:	802.11b/g/n(HT20): 11channels 802.11n(HT40): 7channels
Channel separation:	5MHz
Antenna type:	FPC Antenna
Antenna gain:	1.67dBi



2.3. Accessory Equipment information

Equipment Information			
Name	Model	S/N	Manufacturer
/	/	/	/
/	/	/	/

Cable Information			
Name	Shielded Type	Ferrite Core	Length
/	/	/	/
/	/	/	/

Test Software Information			
Name	Versions	/	/
Engineering mode	/	/	/



2.4. Operation state

Operation Frequency List: The EUT has been tested under typical operating condition. The Applicant provides communication tools software to control the EUT for staying in continuous transmitting and receiving mode for testing.

Operation Frequency List:

Channel	Frequency (MHz)
01	2412
02	2417
03	2422
04	2427
05	2432
06	2437
07	2442
08	2447
09	2452
10	2457
11	2462

Note: CH 01~CH 11 for 802.11b/g/n(HT20), CH 03~CH 09 for 802.11n(HT40)

Data Rated

Preliminary tests were performed in different data rate, and found which the below bit rate is worst case mode, so only show data which it is a worst case mode.

Mode	Data rate (worst mode)
802.11b	1Mbps
802.11g	6Mbps
802.11n(HT20)	HT-MCS0
802.11n(HT40)	HT-MCS0

Test mode

For RF test items:
The engineering test program was provided and enabled to make EUT continuous transmit.
For AC power line conducted emissions:
The EUT was set to connect with the WLAN AP under large package sizes transmission.
For Radiated spurious emissions test item:
The engineering test program was provided and enabled to make EUT continuous transmit. The EUT in each of three orthogonal axis emissions had been tested, but only the worst case (X axis) data Recorded in the report.



2.5. Measurement Instruments List

Tonscend JS0806-2 Test system					
Item	Test Equipment	Manufacturer	Model No.	Serial No.	Calibrated until
1	Spectrum Analyzer	Rohde & Schwarz	FSU26	100105	Dec. 25, 2021
2	Spectrum Analyzer	Rohde & Schwarz	FUV40-N	101331	Mar. 15, 2022
3	Spectrum Analyzer	KEYSIGHT	N9020A	100231	Dec. 25, 2021
4	MXG Vector Signal Generator	Agilent	N5182A	MY47420864	Dec. 25, 2021
5	Signal Generator	Agilent	E8257D	MY46521908	Dec. 25, 2021
6	Power Sensor	Agilent	U2021XA	MY5365004	Dec. 25, 2021
7	Power Sensor	Agilent	U2021XA	MY5365006	Dec. 25, 2021
8	Simultaneous Sampling DAQ	Agilent	U2531A	TW54493510	Dec. 25, 2021
9	Climate Chamber	TABAI	PR-4G	A8708055	Dec. 25, 2021
10	Wideband Radio Communication Tester	Rohde & Schwarz	CMW500	116410	Dec. 25, 2021
11	Climate Chamber	ESPEC	MT3065	/	Dec. 25, 2021
12	300328 v2.2.2 test system	TONSCEND	v2.6	/	/

Radiated emission(3m chamber 2)					
Item	Test Equipment	Manufacturer	Model No.	Serial No.	Calibrated Until
1	Trilog-Broadband Antenna	Schwarzbeck	VULB 9168	9168-1013	Jan.12, 2022
2	Horn Antenna	Schwarzbeck	BBHA 9120D	9120D-647	Dec. 24, 2021
3	Spectrum Analyzer	R&S	FSU26	100105	Dec. 25, 2021
4	Spectrum Analyzer	R&S	FSV40-N	101331	Mar. 15, 2022
5	Pre-Amplifier	SONOMA	310	186194	Dec. 25, 2021
6	Low Noise Pre-Amplifier	EMCI	EMC051835	980075	Dec. 25, 2021
7	Test Receiver	R&S	ESCI7	100967	Dec. 25, 2021

Radiated emission(3m chamber 3)					
Item	Test Equipment	Manufacturer	Model No.	Serial No.	Calibrated Until
1	Trilog-Broadband Antenna	Schwarzbeck	VULB 9168	9168-759	Nov.09, 2021
2	Horn Antenna	Schwarzbeck	BBHA 9120D	9120D-647	Dec. 24, 2021
3	Test Receiver	Keysight	N9038A	MY56400071	Dec. 25, 2021
4	Broadband Prempplier	SCHWARZBECK	BBV9743B	259	Dec. 25, 2021
5	Mirowave Broadband Amplifier	SCHWARZBECK	BBV9718C	111	Dec. 25, 2021



Conducted Emission					
Item	Test Equipment	Manufacturer	Model No.	Serial No.	Calibrated until
1	LISN	R&S	ENV216	101112	Dec. 25, 2021
2	LISN	R&S	ENV216	101113	Dec. 25, 2021
3	EMI Test Receiver	R&S	ESCI	100658	Dec. 25, 2021

Note:1. The Cal. Interval was one year.

2. The cable loss has calculated in test result which connection between each test instruments.

3. TEST ITEM AND RESULTS

3.1. Conducted Emission

Limit

FCC CFR Title 47 Part 15 Subpart C Section 15.207/ RSS - Gen 8.8:

Frequency range (MHz)	Limit (dBuV)	
	Quasi-peak	Average
0.15-0.5	66 to 56*	56 to 46*
0.5-5	56	46
5-30	60	50

* Decreases with the logarithm of the frequency.

Test Configuration

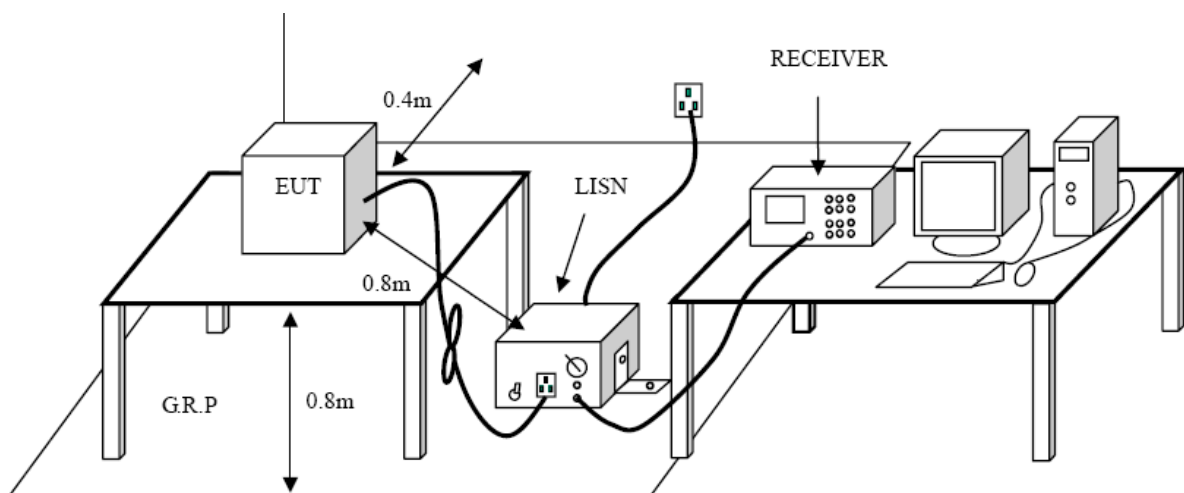

Test Procedure

1. The EUT was setup according to ANSI C63.10:2013 requirements.
2. The EUT was placed on a platform of nominal size, 1 m by 1.5 m, raised 80 cm above the conducting ground plane. The vertical conducting plane was located 40 cm to the rear of the EUT. All other surfaces of EUT were at least 80 cm from any other grounded conducting surface.
3. The EUT and simulators are connected to the main power through a line impedances stabilization network (LISN). The LISN provides a 50ohm /50uH coupling impedance for the measuring equipment. The peripheral devices are also connected to the main power through a LISN. (Please refer to the block diagram of the test setup and photographs)
4. Each current-carrying conductor of the EUT power cord, except the ground (safety) conductor, was individually connected through a LISN to the input power source.
5. The excess length of the power cord between the EUT and the LISN receptacle were folded back and forth at the center of the lead to form a bundle not exceeding 40 cm in length.
6. Conducted Emissions were investigated over the frequency range from 0.15MHz to 30MHz using a receiver bandwidth of 9 kHz.
7. During the above scans, the emissions were maximized by cable manipulation.



Test Mode:

Please refer to the clause 2.4.

Test Results

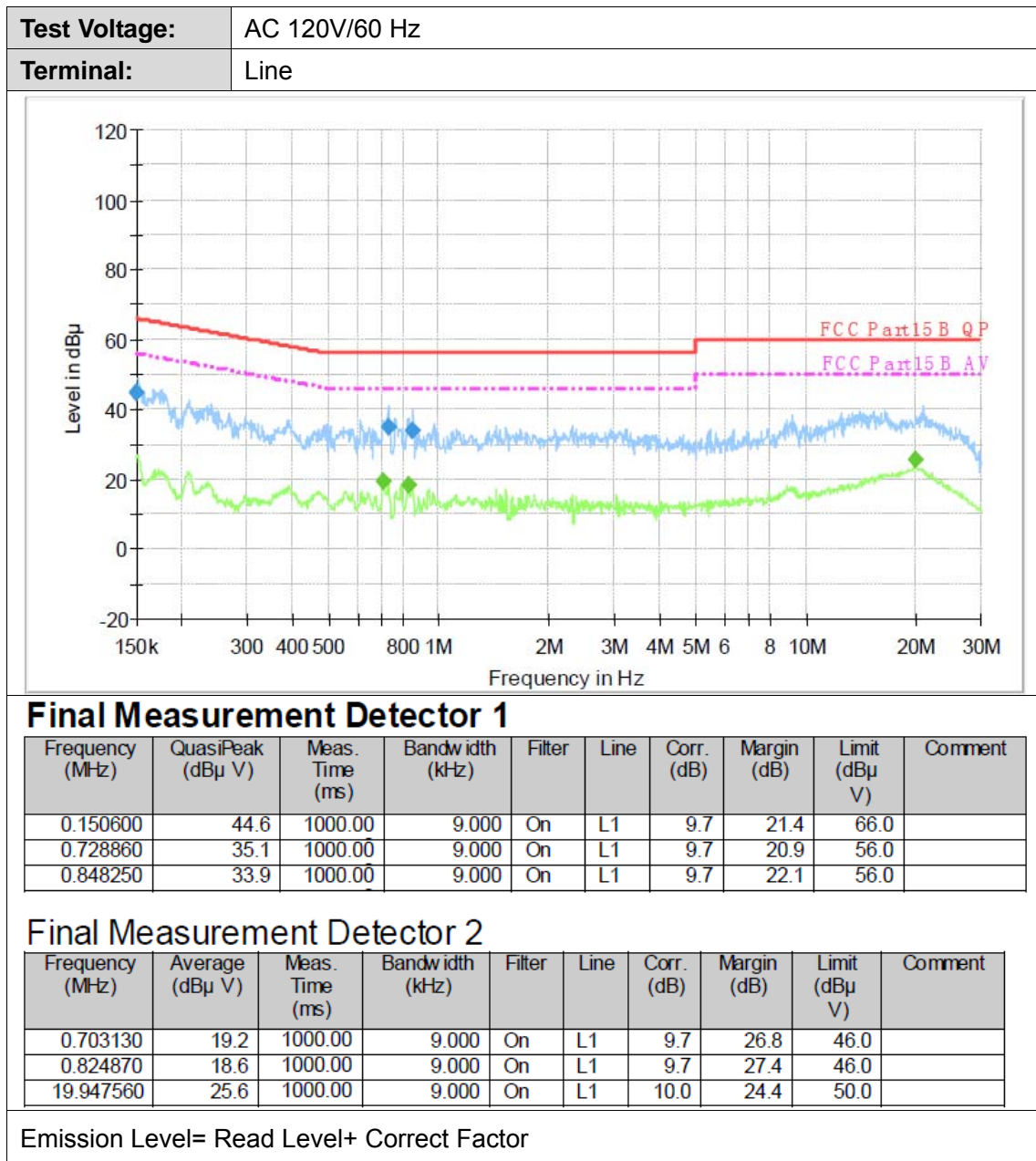



Test Voltage:	AC 120V/60 Hz
Terminal:	Neutral

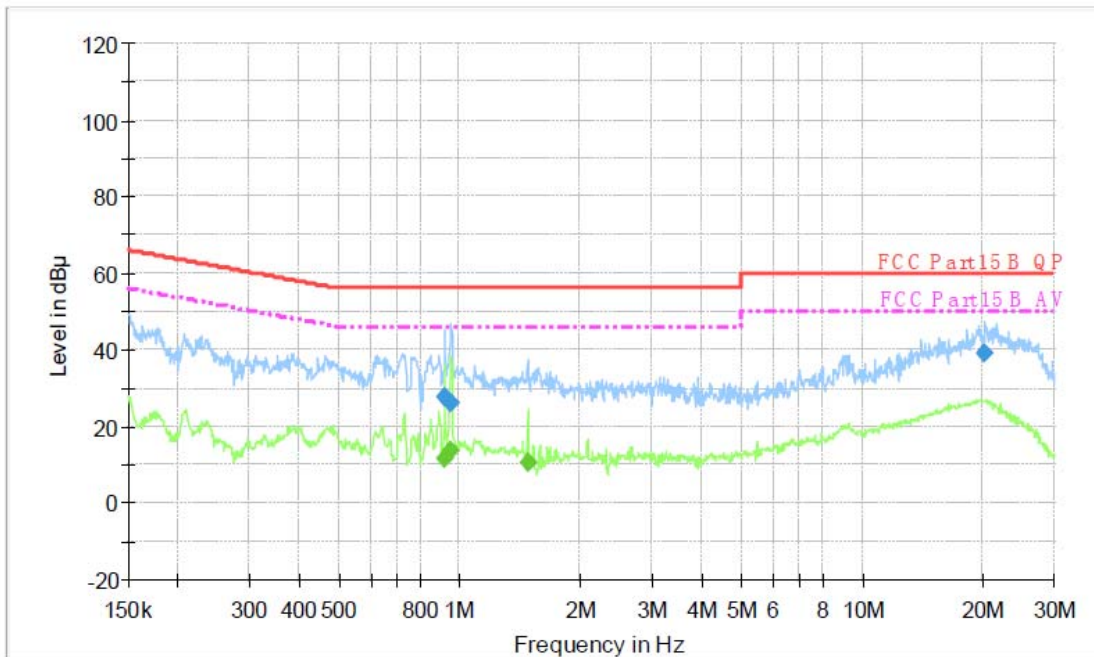

Final Measurement Detector 1

Frequency (MHz)	QuasiPeak (dBµ V)	Meas. Time (ms)	Bandwidth (kHz)	Filter	Line	Corr. (dB)	Margin (dB)	Limit (dBµ V)	Comment
0.918750	27.5	1000.00	9.000	On	N	10.0	28.5	56.0	
0.948560	26.0	1000.00	9.000	On	N	10.0	30.0	56.0	
20.107460	38.9	1000.00	9.000	On	N	10.0	21.1	60.0	

Final Measurement Detector 2

Frequency (MHz)	Average (dBµ V)	Meas. Time (ms)	Bandwidth (kHz)	Filter	Line	Corr. (dB)	Margin (dB)	Limit (dBµ V)	Comment
0.918750	11.5	1000.00	9.000	On	N	10.0	34.5	46.0	
0.952360	13.6	1000.00	9.000	On	N	10.0	32.4	46.0	
1.477440	10.5	1000.00	9.000	On	N	10.0	35.5	46.0	

Emission Level= Read Level+ Correct Factor

3.2. Radiated Emission

Limit

FCC CFR Title 47 Part 15 Subpart C Section 15.209/ RSS – Gen 8.9:

Frequency	Limit (dBuV/m @3m)	Value
30 MHz ~ 88 MHz	40.00	Quasi-peak
88 MHz ~ 216 MHz	43.50	Quasi-peak
216 MHz ~ 960 MHz	46.00	Quasi-peak
960 MHz ~ 1 GHz	54.00	Quasi-peak
Above 1 GHz	54.00	Average
	74.00	Peak

Note:

- (1) The tighter limit applies at the band edges.
- (2) Emission Level (dBuV/m)=20log Emission Level (uV/m).

Test Configuration

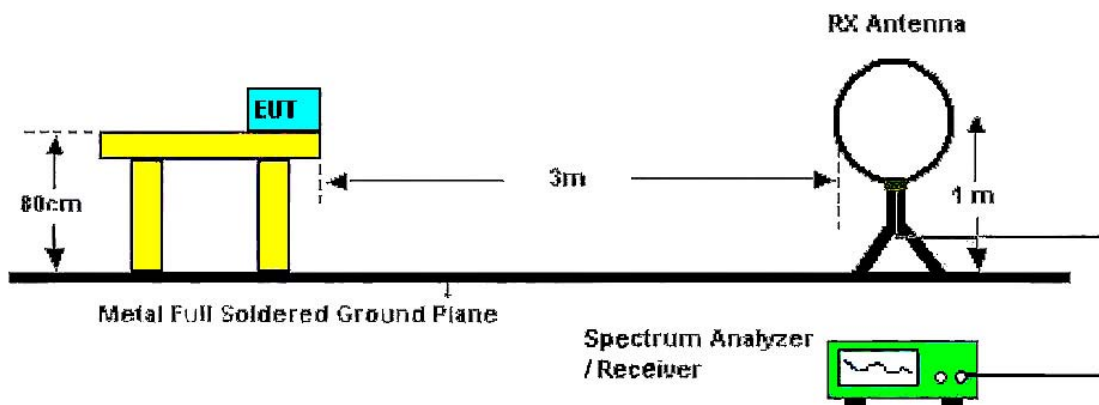

Below 30MHz Test Setup

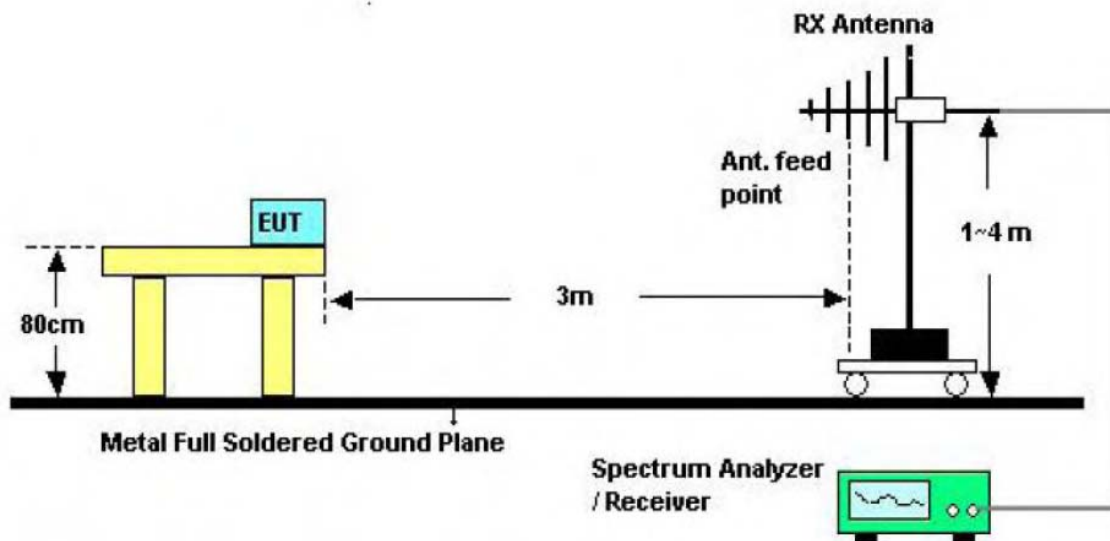

Below 1000MHz Test Setup

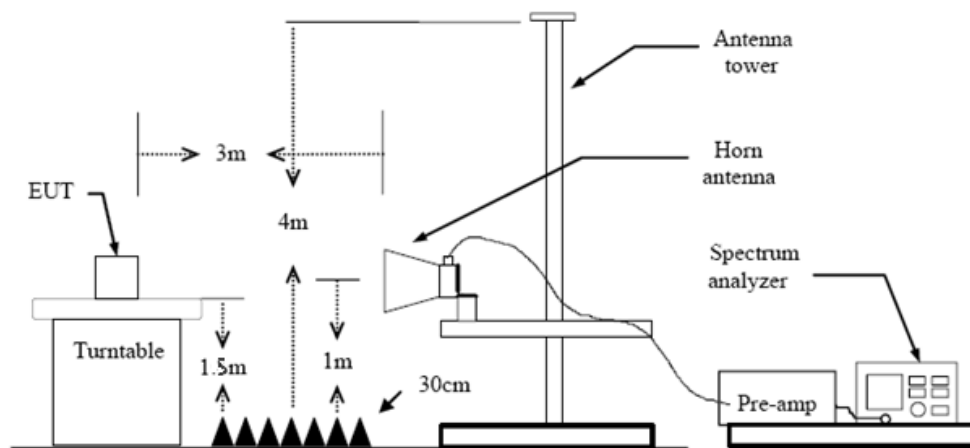

Above 1GHz Test Setup

Test Procedure

1. The EUT was setup and tested according to ANSI C63.10:2013
 2. The EUT is placed on a turn table which is 0.8 meter above ground for below 1 GHz, and 1.5 m for above 1 GHz. The turn table is rotated 360 degrees to determine the position of the maximum emission level.
 3. The EUT was set 3 meters from the receiving antenna, which was mounted on the top of a variable height antenna tower.
 4. For each suspected emission, the EUT was arranged to its worst case and then tune the Antenna tower (from 1 m to 4 m) and turntable (from 0 degree to 360 degrees) to find the maximum reading. A pre-amp and a high pass filter are used for the test in order to get better signal level to comply with the guidelines.
 5. Set to the maximum power setting and enable the EUT transmit continuously.
 6. Use the following spectrum analyzer settings
 - (1) Span shall wide enough to fully capture the emission being measured;
 - (2) Below 1 GHz:
RBW=120 kHz, VBW=300 kHz, Sweep=auto, Detector function=peak, Trace=max hold;
If the emission level of the EUT measured by the peak detector is 3 dB lower than the applicable limit, the peak emission level will be reported. Otherwise, the emission measurement will be repeated using the quasi-peak detector and reported.
 - (3) From 1 GHz to 10th harmonic:
RBW=1MHz, VBW=3MHz Peak detector for Peak value.
RBW=1MHz, VBW \geq 1/T Peak detector for Average value.
- Note 1: For the 1/T & Duty Cycle please refer to clause 3.8 Duty Cycle.

Test Mode

Please refer to the clause 2.4.

Test Result

9 KHz~30 MHz

From 9 KHz to 30 MHz: Conclusion: PASS

Note: The amplitude of spurious emissions which are attenuated by more than 20dB below the permissible value has no need to be reported.



30MHz-1GHz

Ant. Pol.	Horizontal
Test Mode:	802.11b Mode 2412MHz
Remark:	Only worse case is reported

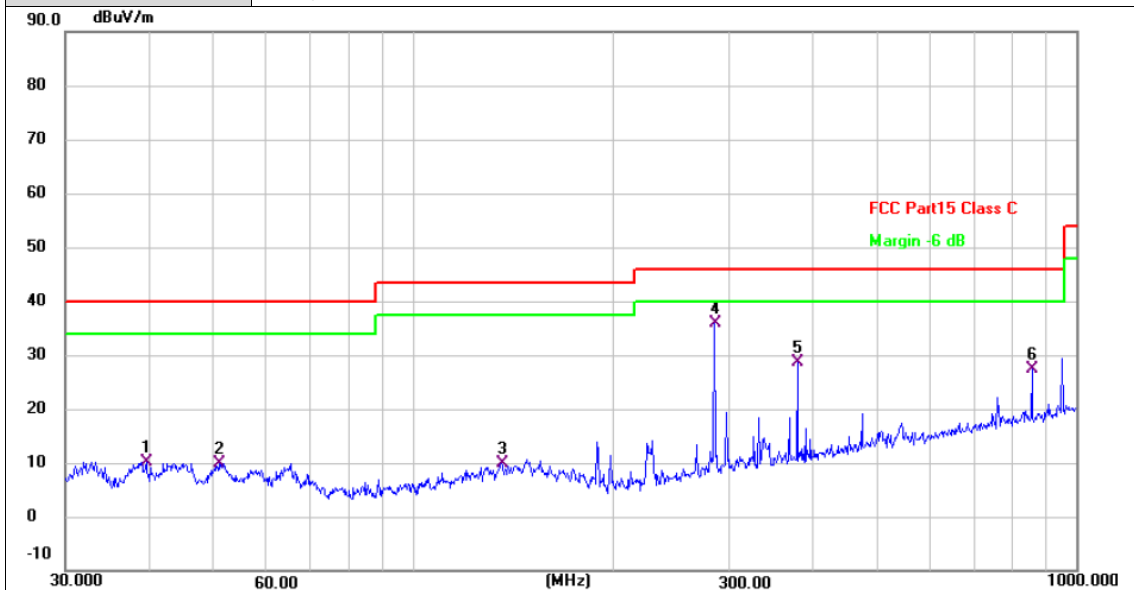

No.	Frequency (MHz)	Reading (dBuV)	Factor (dB/m)	Level (dBuV/m)	Limit (dBuV/m)	Margin (dB)	Detector
1	39.7146	27.57	-17.33	10.24	40.00	-29.76	QP
2	51.1209	27.80	-17.86	9.94	40.00	-30.06	QP
3	135.9822	27.98	-18.00	9.98	43.50	-33.52	QP
4 *	284.9767	54.18	-18.22	35.96	46.00	-10.04	QP
5	379.9141	44.81	-16.18	28.63	46.00	-17.37	QP
6	857.0247	36.20	-8.81	27.39	46.00	-18.61	QP

Remarks:

- Factor (dB/m) = Antenna Factor (dB/m)+Cable Factor (dB)-Pre-amplifier Factor
- Margin value = Level -Limit value



Ant. Pol.	Vertical
Test Mode:	802.11b Mode 2412MHz
Remark:	Only worse case is reported

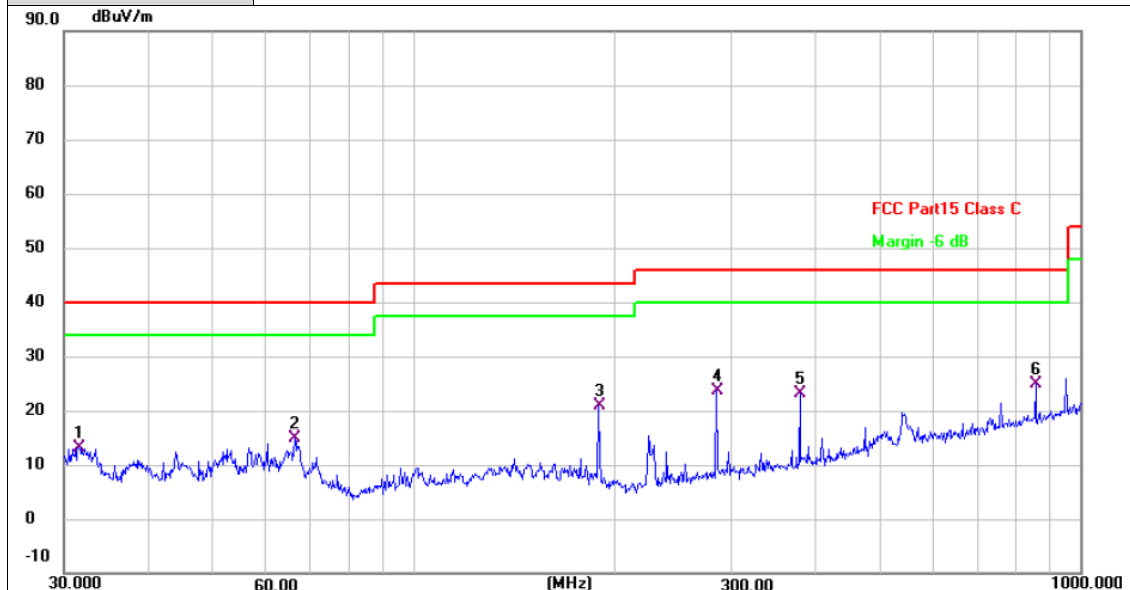

No.	Frequency (MHz)	Reading (dBuV)	Factor (dB/m)	Level (dBuV/m)	Limit (dBuV/m)	Margin (dB)	Detector
1	31.5095	31.30	-18.13	13.17	40.00	-26.83	QP
2	66.4989	34.64	-19.74	14.90	40.00	-25.10	QP
3	189.7385	40.95	-20.10	20.85	43.50	-22.65	QP
4	284.9767	41.95	-18.22	23.73	46.00	-22.27	QP
5	379.9141	39.40	-16.18	23.22	46.00	-22.78	QP
6 *	857.0247	33.69	-8.81	24.88	46.00	-21.12	QP

Remarks:

1. Factor (dB/m) = Antenna Factor (dB/m)+Cable Factor (dB)-Pre-amplifier Factor
2. Margin value = Level -Limit value



Adobe 1GHz

Ant. Pol.	Horizontal
Test Mode:	TX 802.11b Mode 2412MHz
Remark:	No report for the emission which more than 10 dB below the prescribed limit.

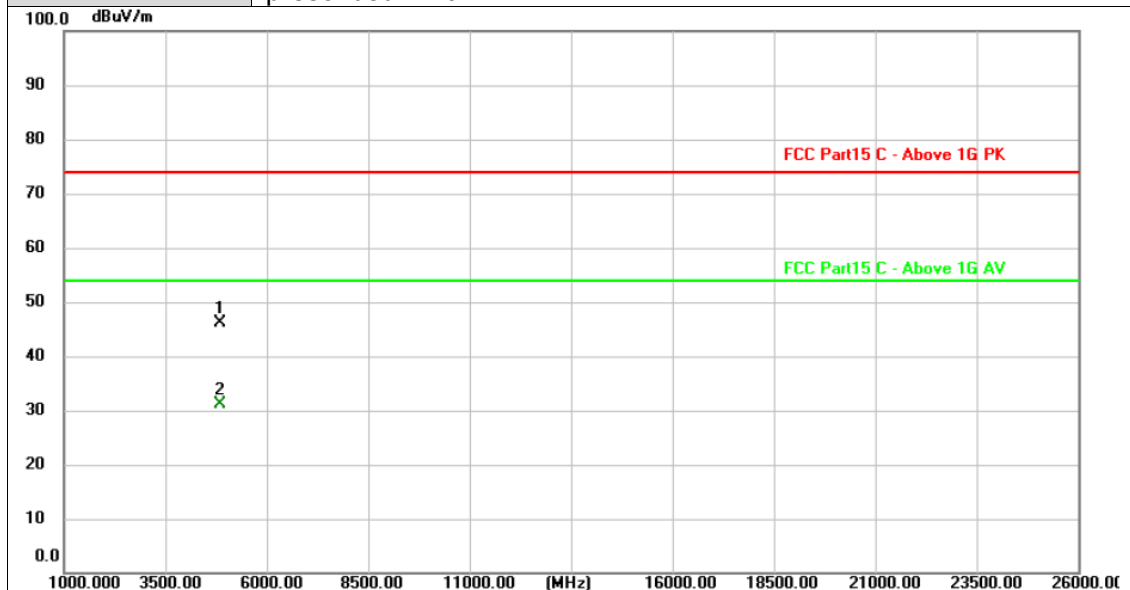

No.	Frequency (MHz)	Reading (dBuV)	Factor (dB/m)	Level (dBuV/m)	Limit (dBuV/m)	Margin (dB)	Detector
1	4824.165	42.92	3.17	46.09	74.00	-27.91	peak
2 *	4824.981	27.86	3.17	31.03	54.00	-22.97	AVG

Remarks:

- 1. Factor (dB/m) = Antenna Factor (dB/m)+Cable Factor (dB)-Pre-amplifier Factor
- 2. Margin value = Level -Limit value



Ant. Pol.	Vertical
Test Mode:	TX 802.11b Mode 2412MHz
Remark:	No report for the emission which more than 10 dB below the prescribed limit.

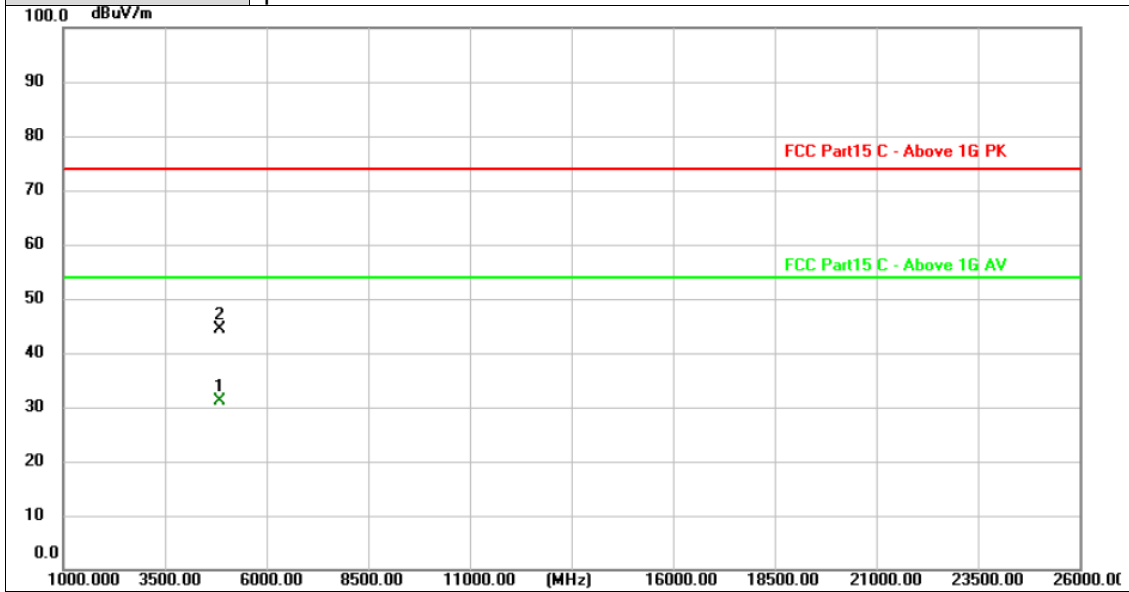

No.	Frequency (MHz)	Reading (dBuV)	Factor (dB/m)	Level (dBuV/m)	Limit (dBuV/m)	Margin (dB)	Detector
1 *	4823.027	27.87	3.17	31.04	54.00	-22.96	AVG
2	4824.936	41.30	3.17	44.47	74.00	-29.53	peak

Remarks:
 1.Factor (dB/m) = Antenna Factor (dB/m)+Cable Factor (dB)-Pre-amplifier Factor
 2.Margin value = Level -Limit value



Ant. Pol.	Horizontal
Test Mode:	TX 802.11b Mode 2437MHz
Remark:	No report for the emission which more than 10 dB below the prescribed limit.

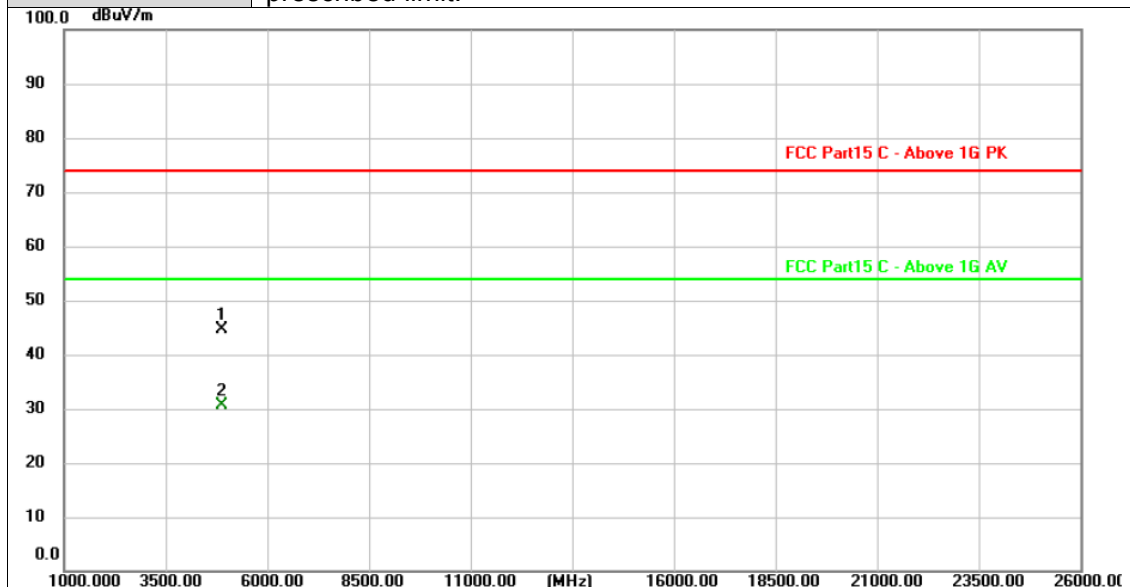

No.	Frequency (MHz)	Reading (dBuV)	Factor (dB/m)	Level (dBuV/m)	Limit (dBuV/m)	Margin (dB)	Detector
1	4874.169	41.29	3.32	44.61	74.00	-29.39	peak
2 *	4874.739	27.41	3.32	30.73	54.00	-23.27	AVG

Remarks:

- Factor (dB/m) = Antenna Factor (dB/m)+Cable Factor (dB)-Pre-amplifier Factor
- Margin value = Level -Limit value



Ant. Pol.	Vertical
Test Mode:	TX 802.11b Mode 2437MHz
Remark:	No report for the emission which more than 10 dB below the prescribed limit.

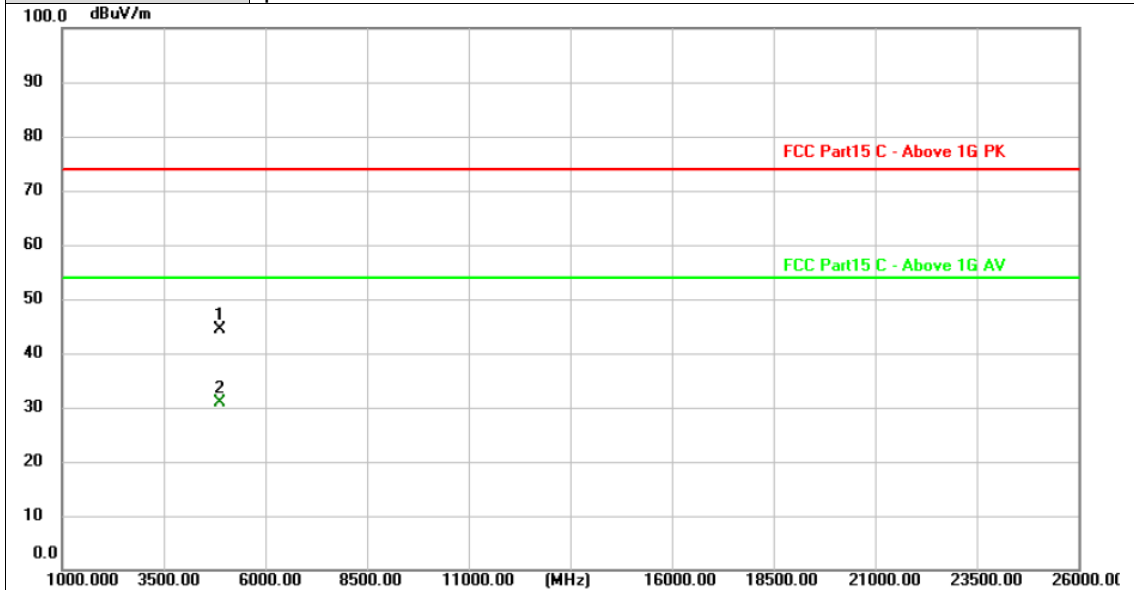

No.	Frequency (MHz)	Reading (dBuV)	Factor (dB/m)	Level (dBuV/m)	Limit (dBuV/m)	Margin (dB)	Detector
1	4874.118	41.12	3.32	44.44	74.00	-29.56	peak
2 *	4874.929	27.62	3.32	30.94	54.00	-23.06	AVG

Remarks:
 1. Factor (dB/m) = Antenna Factor (dB/m)+Cable Factor (dB)-Pre-amplifier Factor
 2. Margin value = Level -Limit value



Ant. Pol.	Horizontal
Test Mode:	TX 802.11b Mode 2462MHz
Remark:	No report for the emission which more than 10 dB below the prescribed limit.

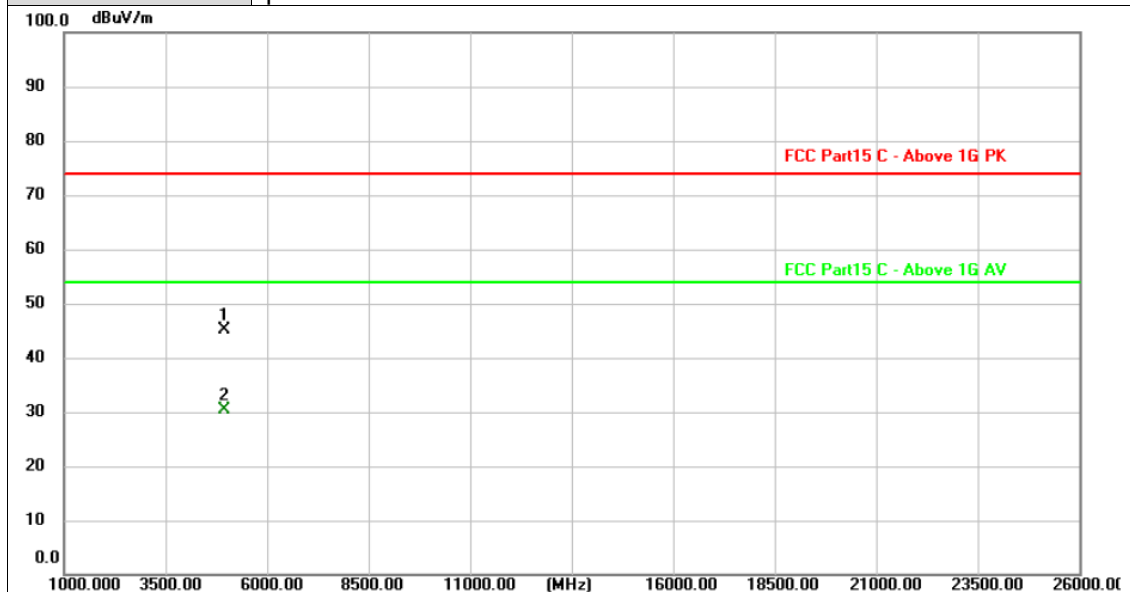

No.	Frequency (MHz)	Reading (dBuV)	Factor (dB/m)	Level (dBuV/m)	Limit (dBuV/m)	Margin (dB)	Detector
1	4924.571	41.69	3.47	45.16	74.00	-28.84	peak
2 *	4924.653	26.83	3.47	30.30	54.00	-23.70	AVG

Remarks:

- 1.Factor (dB/m) = Antenna Factor (dB/m)+Cable Factor (dB)-Pre-amplifier Factor
- 2.Margin value = Level -Limit value



Ant. Pol.	Vertical
Test Mode:	TX 802.11b Mode 2462MHz
Remark:	No report for the emission which more than 10 dB below the prescribed limit.

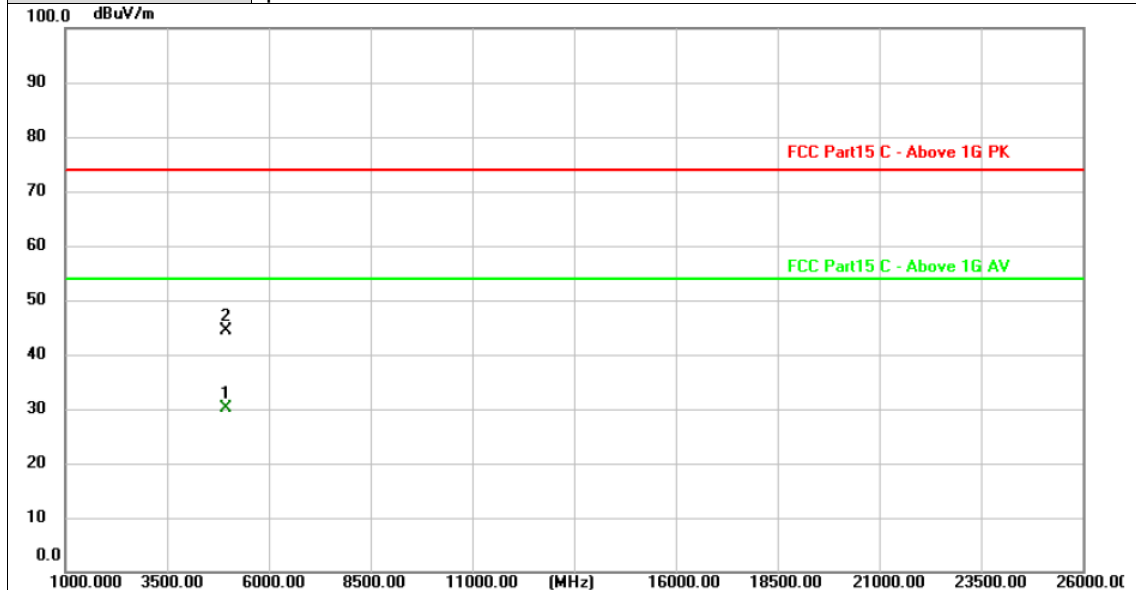

No.	Frequency (MHz)	Reading (dBuV)	Factor (dB/m)	Level (dBuV/m)	Limit (dBuV/m)	Margin (dB)	Detector
1 *	4924.537	26.72	3.47	30.19	54.00	-23.81	AVG
2	4924.682	40.84	3.47	44.31	74.00	-29.69	peak

Remarks:
 1.Factor (dB/m) = Antenna Factor (dB/m)+Cable Factor (dB)-Pre-amplifier Factor
 2.Margin value = Level -Limit value



Ant. Pol.	Horizontal
Test Mode:	TX 802.11g Mode 2412MHz
Remark:	No report for the emission which more than 10 dB below the prescribed limit.

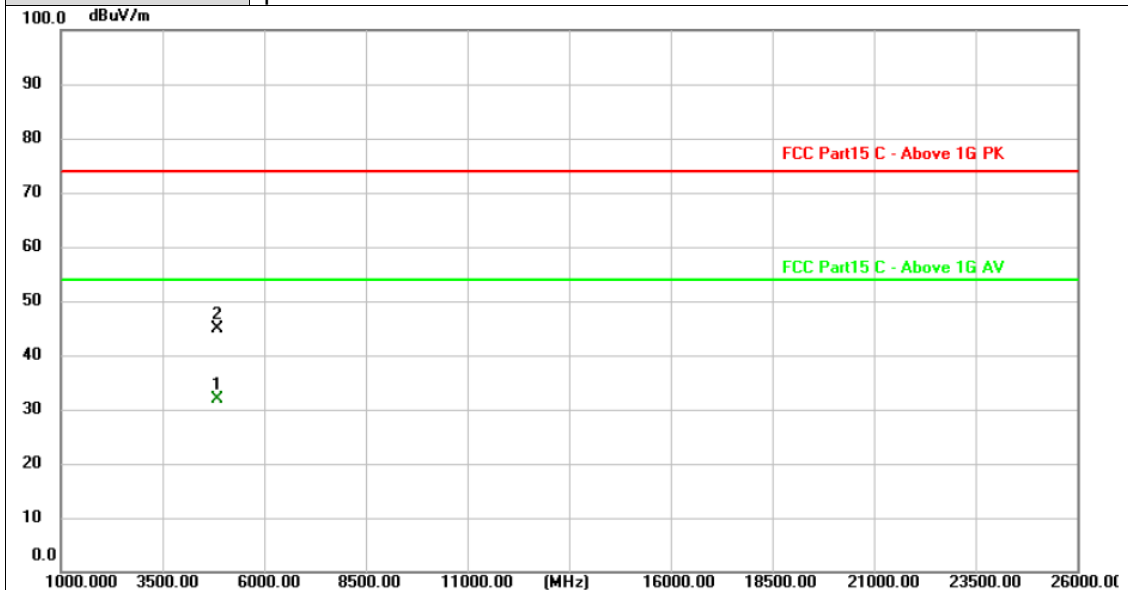

No.	Frequency (MHz)	Reading (dBuV)	Factor (dB/m)	Level (dBuV/m)	Limit (dBuV/m)	Margin (dB)	Detector
1 *	4823.811	28.67	3.17	31.84	54.00	-22.16	AVG
2	4824.428	41.61	3.17	44.78	74.00	-29.22	peak

Remarks:
 1.Factor (dB/m) = Antenna Factor (dB/m)+Cable Factor (dB)-Pre-amplifier Factor
 2.Margin value = Level -Limit value



Ant. Pol.	Vertical
Test Mode:	TX 802.11g Mode 2412MHz
Remark:	No report for the emission which more than 10 dB below the prescribed limit.

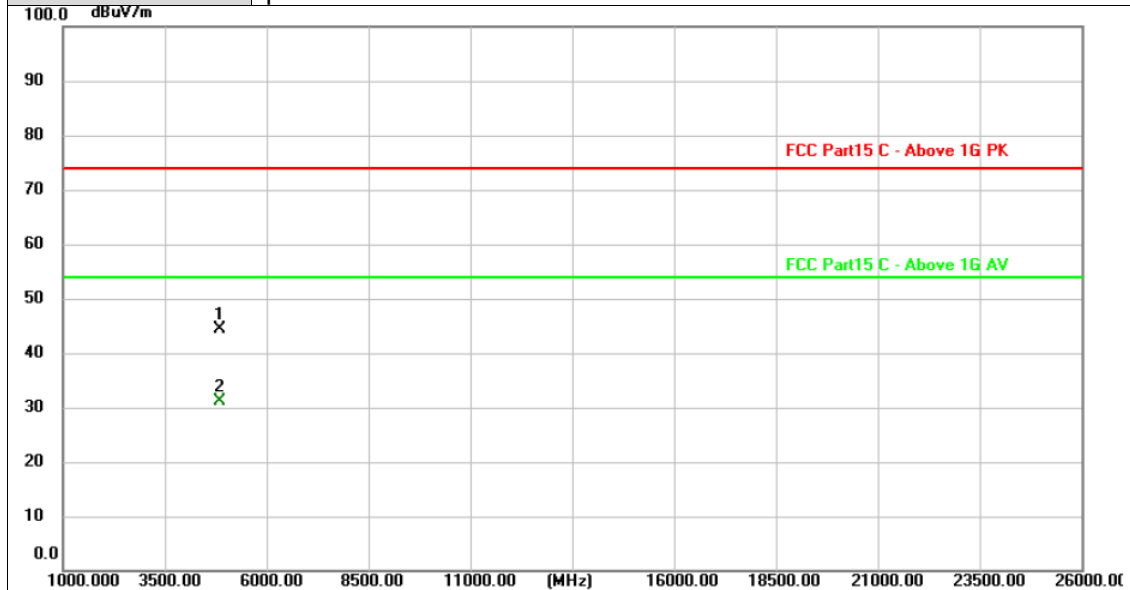

No.	Frequency (MHz)	Reading (dBuV)	Factor (dB/m)	Level (dBuV/m)	Limit (dBuV/m)	Margin (dB)	Detector
1	4824.081	41.11	3.17	44.28	74.00	-29.72	peak
2 *	4824.279	27.97	3.17	31.14	54.00	-22.86	AVG

Remarks:

- 1. Factor (dB/m) = Antenna Factor (dB/m)+Cable Factor (dB)-Pre-amplifier Factor
- 2. Margin value = Level -Limit value



Ant. Pol.	Horizontal
Test Mode:	TX 802.11g Mode 2437MHz
Remark:	No report for the emission which more than 10 dB below the prescribed limit.

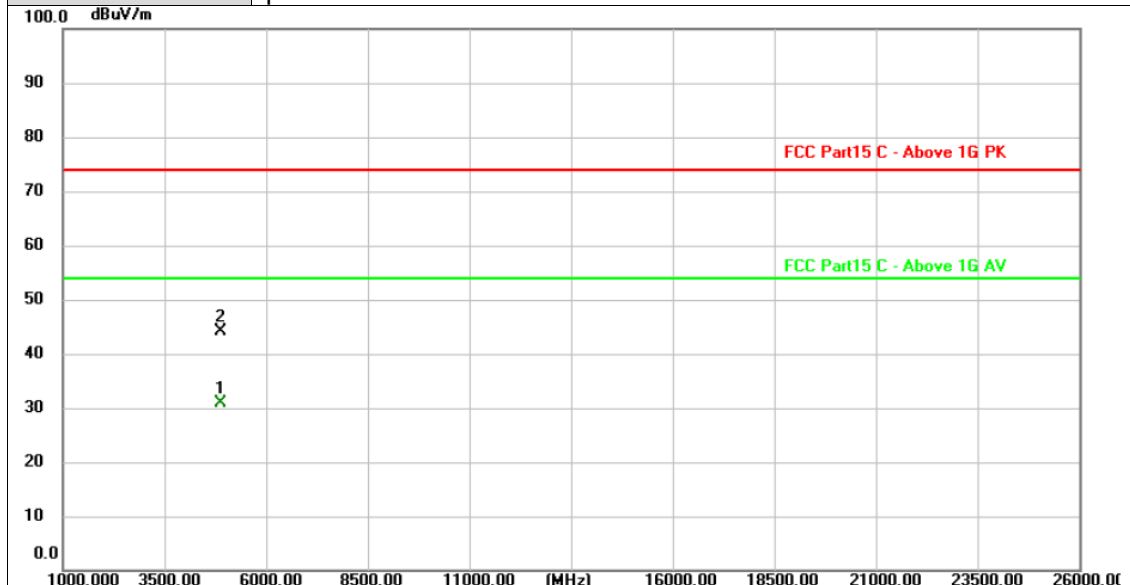

No.	Frequency (MHz)	Reading (dBuV)	Factor (dB/m)	Level (dBuV/m)	Limit (dBuV/m)	Margin (dB)	Detector
1 *	4873.739	27.59	3.32	30.91	54.00	-23.09	AVG
2	4873.933	40.89	3.32	44.21	74.00	-29.79	peak

Remarks:

- Factor (dB/m) = Antenna Factor (dB/m)+Cable Factor (dB)-Pre-amplifier Factor
- Margin value = Level -Limit value



Ant. Pol.	Vertical
Test Mode:	TX 802.11g Mode 2437MHz
Remark:	No report for the emission which more than 10 dB below the prescribed limit.

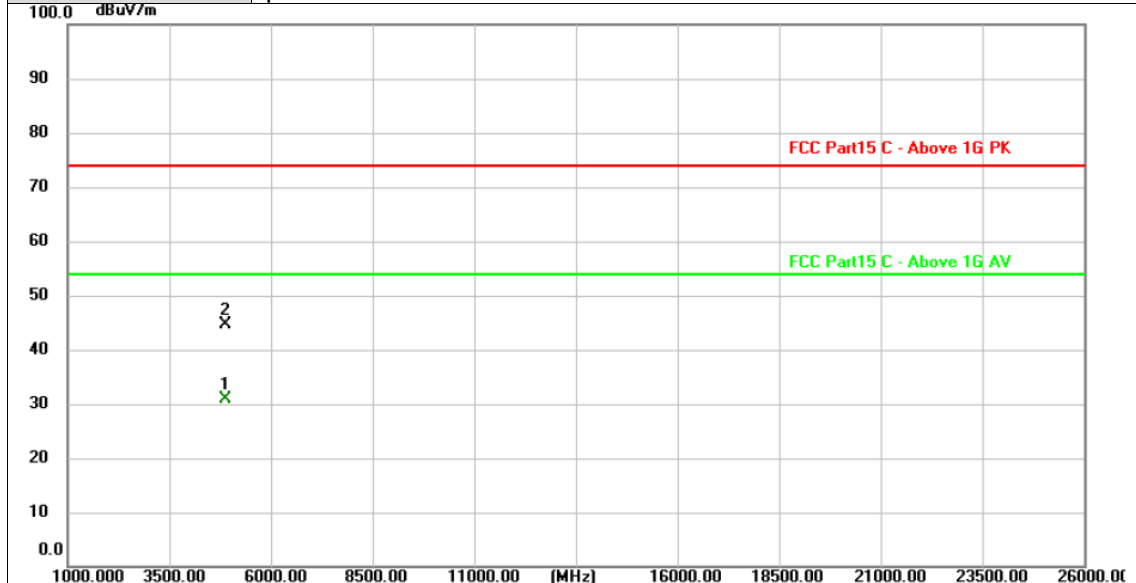

No.	Frequency (MHz)	Reading (dBuV)	Factor (dB/m)	Level (dBuV/m)	Limit (dBuV/m)	Margin (dB)	Detector
1 *	4873.510	27.50	3.32	30.82	54.00	-23.18	AVG
2	4873.615	41.39	3.32	44.71	74.00	-29.29	peak

Remarks:

1. Factor (dB/m) = Antenna Factor (dB/m)+Cable Factor (dB)-Pre-amplifier Factor
2. Margin value = Level -Limit value



Ant. Pol.	Horizontal
Test Mode:	TX 802.11g Mode 2462MHz
Remark:	No report for the emission which more than 10 dB below the prescribed limit.

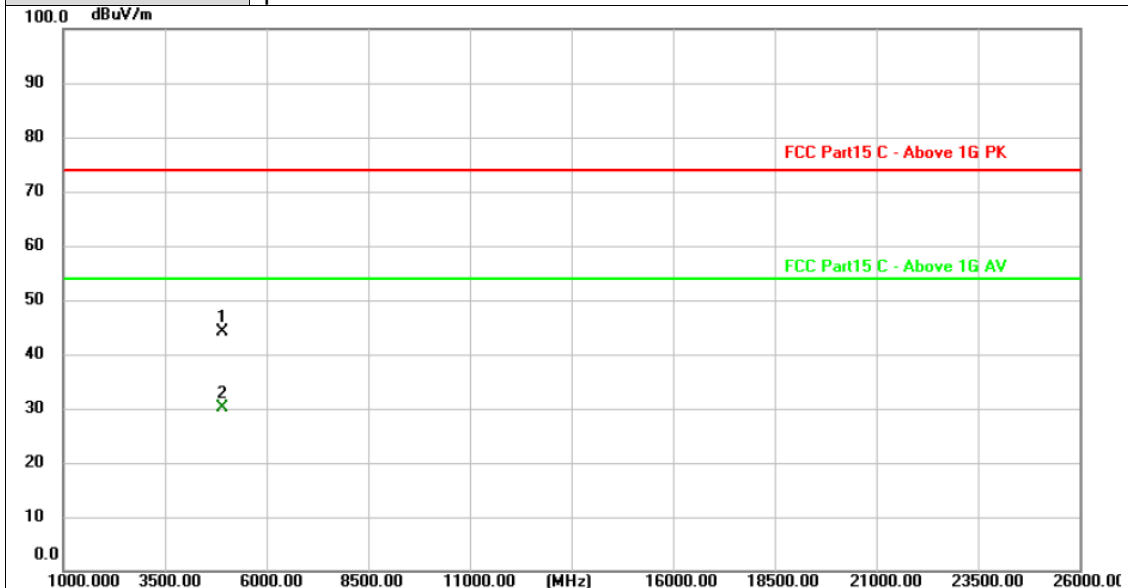

No.	Frequency (MHz)	Reading (dBuV)	Factor (dB/m)	Level (dBuV/m)	Limit (dBuV/m)	Margin (dB)	Detector
1	4923.426	40.78	3.47	44.25	74.00	-29.75	peak
2 *	4924.049	26.77	3.47	30.24	54.00	-23.76	AVG

Remarks:
 1. Factor (dB/m) = Antenna Factor (dB/m)+Cable Factor (dB)-Pre-amplifier Factor
 2. Margin value = Level -Limit value



Ant. Pol.	Vertical
Test Mode:	TX 802.11g Mode 2462MHz
Remark:	No report for the emission which more than 10 dB below the prescribed limit.

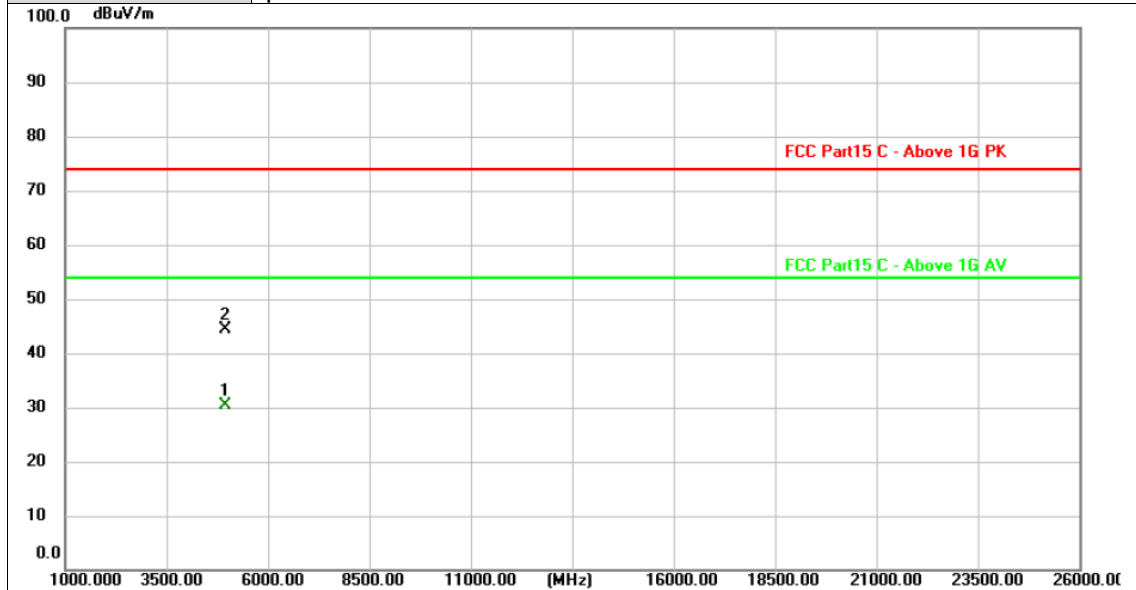

No.	Frequency (MHz)	Reading (dBuV)	Factor (dB/m)	Level (dBuV/m)	Limit (dBuV/m)	Margin (dB)	Detector
1 *	4923.035	26.80	3.47	30.27	54.00	-23.73	AVG
2	4923.784	40.95	3.47	44.42	74.00	-29.58	peak

Remarks:

- 1. Factor (dB/m) = Antenna Factor (dB/m)+Cable Factor (dB)-Pre-amplifier Factor
- 2. Margin value = Level -Limit value



Ant. Pol.	Horizontal
Test Mode:	TX 802.11n(HT20) Mode 2412MHz
Remark:	No report for the emission which more than 10 dB below the prescribed limit.

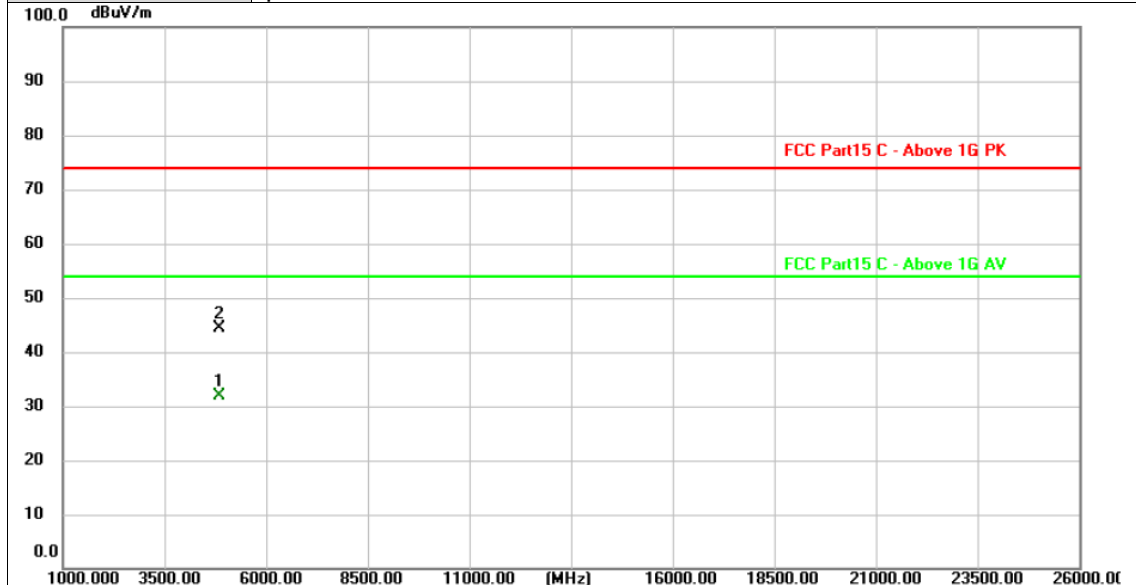

No.	Frequency (MHz)	Reading (dBuV)	Factor (dB/m)	Level (dBuV/m)	Limit (dBuV/m)	Margin (dB)	Detector
1 *	4824.043	28.73	3.17	31.90	54.00	-22.10	AVG
2	4824.415	41.28	3.17	44.45	74.00	-29.55	peak

Remarks:

1. Factor (dB/m) = Antenna Factor (dB/m)+Cable Factor (dB)-Pre-amplifier Factor
2. Margin value = Level -Limit value



Ant. Pol.	Vertical
Test Mode:	TX 802.11n(HT20) Mode 2412MHz
Remark:	No report for the emission which more than 10 dB below the prescribed limit.

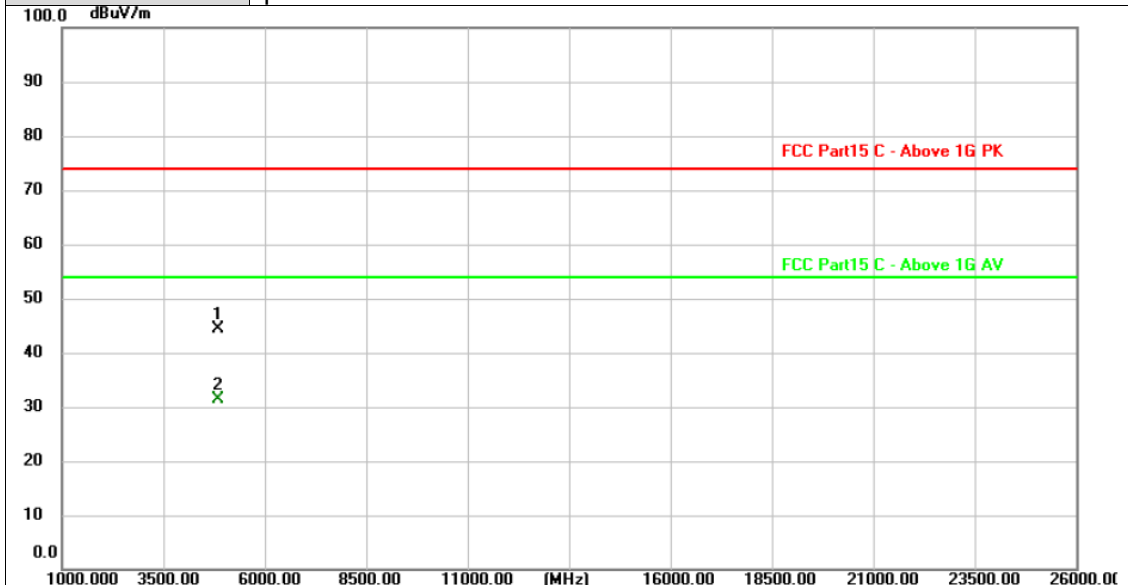

No.	Frequency (MHz)	Reading (dBuV)	Factor (dB/m)	Level (dBuV/m)	Limit (dBuV/m)	Margin (dB)	Detector
1	4823.573	41.13	3.17	44.30	74.00	-29.70	peak
2 *	4823.860	28.21	3.17	31.38	54.00	-22.62	AVG

Remarks:
 1. Factor (dB/m) = Antenna Factor (dB/m)+Cable Factor (dB)-Pre-amplifier Factor
 2. Margin value = Level -Limit value



Ant. Pol.	Horizontal
Test Mode:	TX 802.11n(HT20) Mode 2437MHz
Remark:	No report for the emission which more than 10 dB below the prescribed limit.

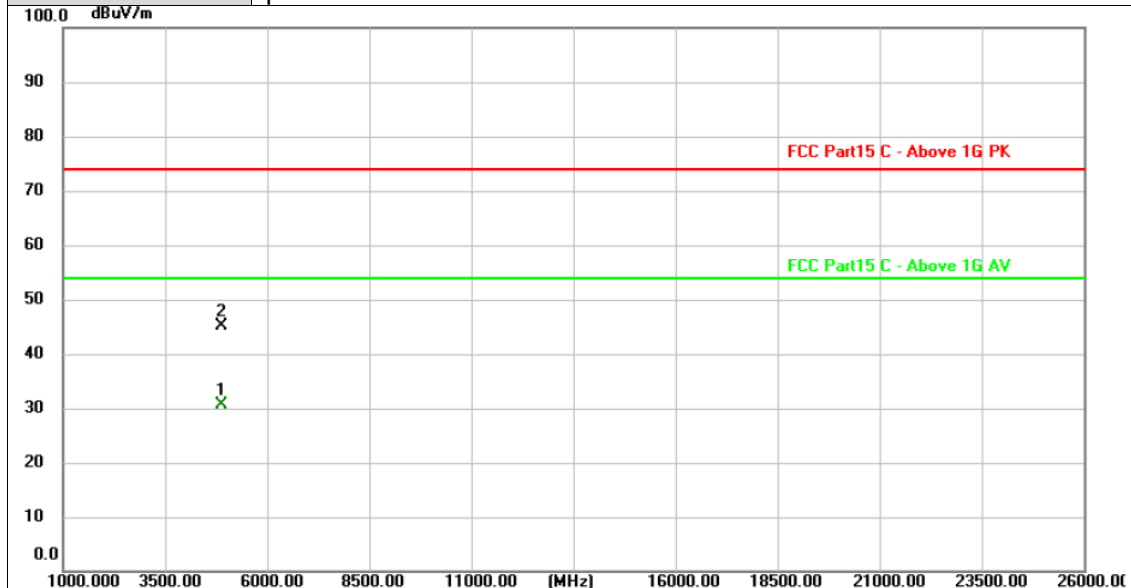

No.	Frequency (MHz)	Reading (dBuV)	Factor (dB/m)	Level (dBuV/m)	Limit (dBuV/m)	Margin (dB)	Detector
1 *	4874.001	27.29	3.32	30.61	54.00	-23.39	AVG
2	4874.225	41.91	3.32	45.23	74.00	-28.77	peak

Remarks:

- Factor (dB/m) = Antenna Factor (dB/m)+Cable Factor (dB)-Pre-amplifier Factor
- Margin value = Level -Limit value



Ant. Pol.	Vertical
Test Mode:	TX 802.11n(HT20) Mode 2437MHz
Remark:	No report for the emission which more than 10 dB below the prescribed limit.

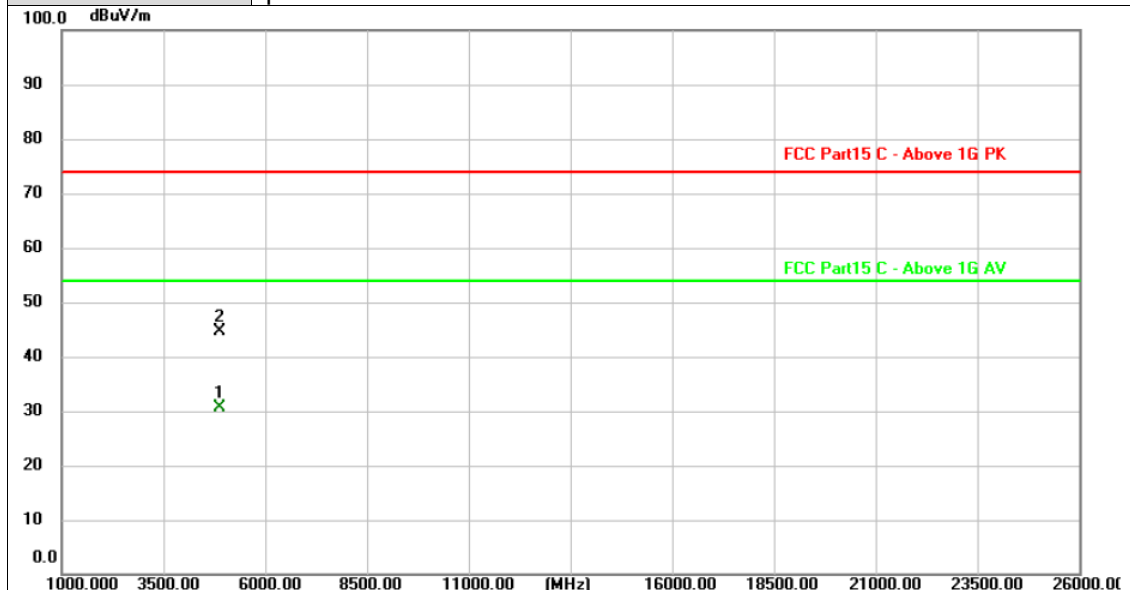

No.	Frequency (MHz)	Reading (dBuV)	Factor (dB/m)	Level (dBuV/m)	Limit (dBuV/m)	Margin (dB)	Detector
1 *	4873.592	27.39	3.32	30.71	54.00	-23.29	AVG
2	4874.839	41.38	3.32	44.70	74.00	-29.30	peak

Remarks:

- 1. Factor (dB/m) = Antenna Factor (dB/m)+Cable Factor (dB)-Pre-amplifier Factor
- 2. Margin value = Level -Limit value



Ant. Pol.	Horizontal
Test Mode:	TX 802.11n(HT20) Mode 2462MHz
Remark:	No report for the emission which more than 10 dB below the prescribed limit.

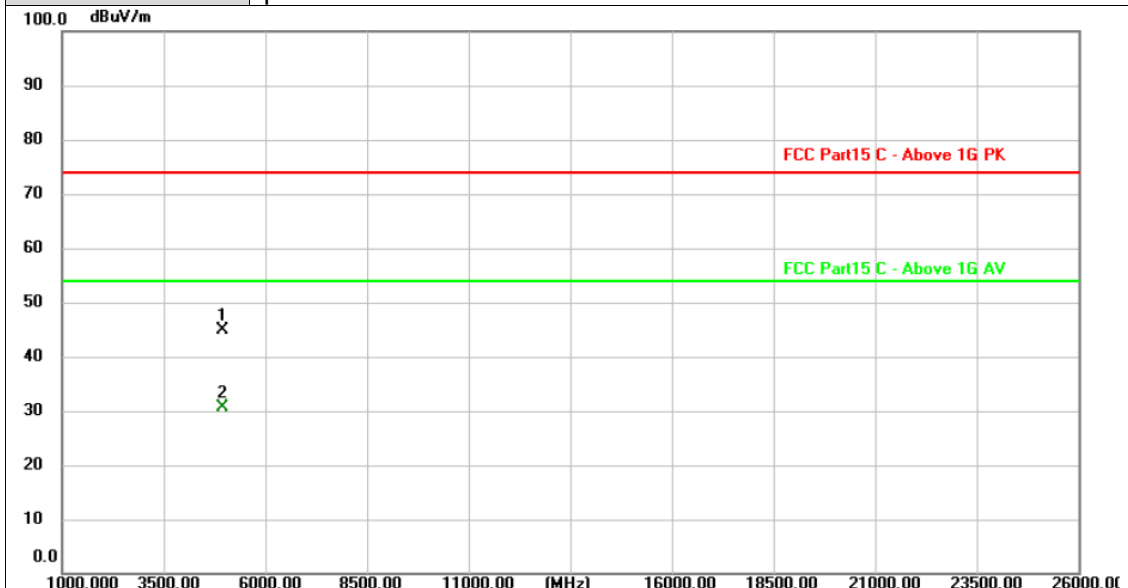

No.	Frequency (MHz)	Reading (dBuV)	Factor (dB/m)	Level (dBuV/m)	Limit (dBuV/m)	Margin (dB)	Detector
1	4923.883	41.47	3.47	44.94	74.00	-29.06	peak
2 *	4924.863	27.19	3.47	30.66	54.00	-23.34	AVG

Remarks:

- 1.Factor (dB/m) = Antenna Factor (dB/m)+Cable Factor (dB)-Pre-amplifier Factor
- 2.Margin value = Level -Limit value



Ant. Pol.	Vertical
Test Mode:	TX 802.11n(HT20) Mode 2462MHz
Remark:	No report for the emission which more than 10 dB below the prescribed limit.

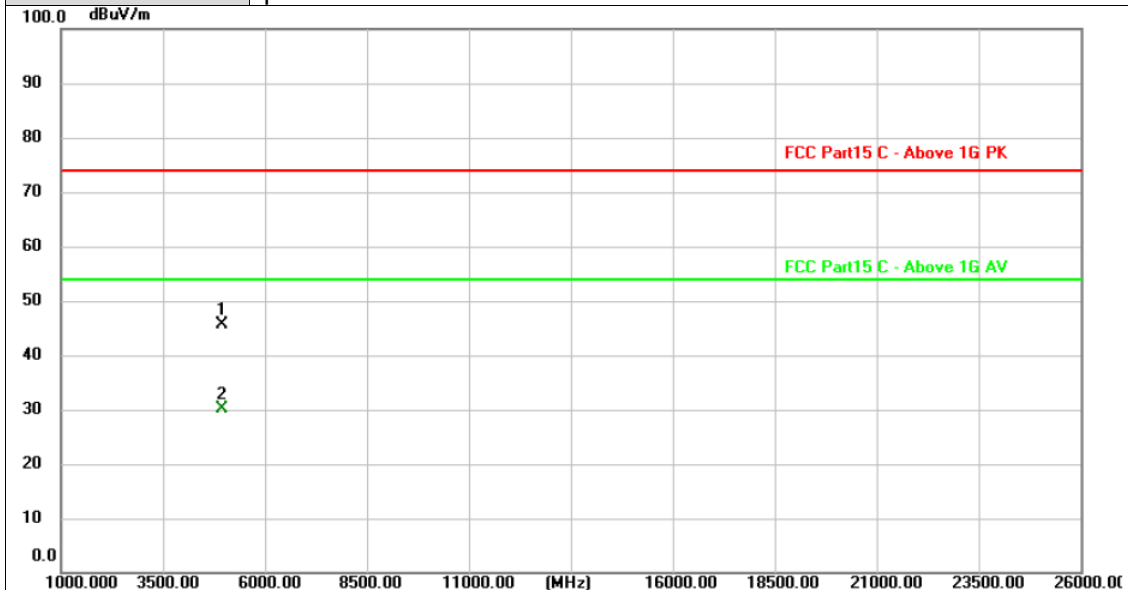

No.	Frequency (MHz)	Reading (dBuV)	Factor (dB/m)	Level (dBuV/m)	Limit (dBuV/m)	Margin (dB)	Detector
1	4923.697	42.08	3.47	45.55	74.00	-28.45	peak
2 *	4924.923	26.62	3.47	30.09	54.00	-23.91	AVG

Remarks:

- 1.Factor (dB/m) = Antenna Factor (dB/m)+Cable Factor (dB)-Pre-amplifier Factor
- 2.Margin value = Level -Limit value



Ant. Pol.	Horizontal
Test Mode:	TX 802.11n(HT40) Mode 2422MHz
Remark:	No report for the emission which more than 10 dB below the prescribed limit.

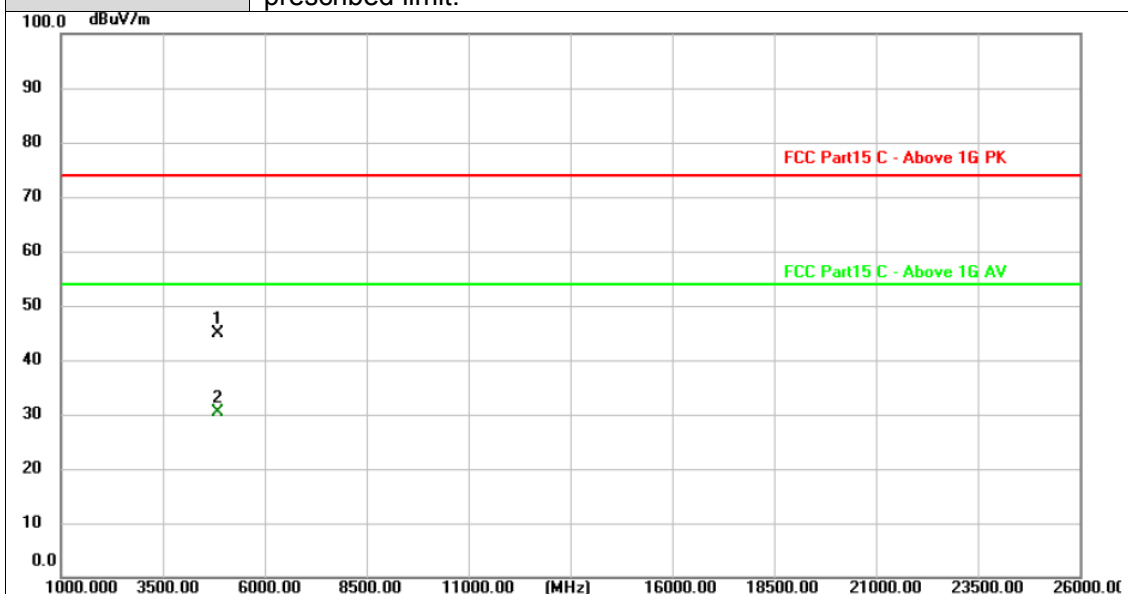

No.	Frequency (MHz)	Reading (dBuV)	Factor (dB/m)	Level (dBuV/m)	Limit (dBuV/m)	Margin (dB)	Detector
1	4843.409	41.58	3.23	44.81	74.00	-29.19	peak
2 *	4844.283	27.18	3.23	30.41	54.00	-23.59	AVG

Remarks:

- 1. Factor (dB/m) = Antenna Factor (dB/m)+Cable Factor (dB)-Pre-amplifier Factor
- 2. Margin value = Level -Limit value



Ant. Pol.	Vertical
Test Mode:	TX 802.11n(HT40) Mode 2422MHz
Remark:	No report for the emission which more than 10 dB below the prescribed limit.

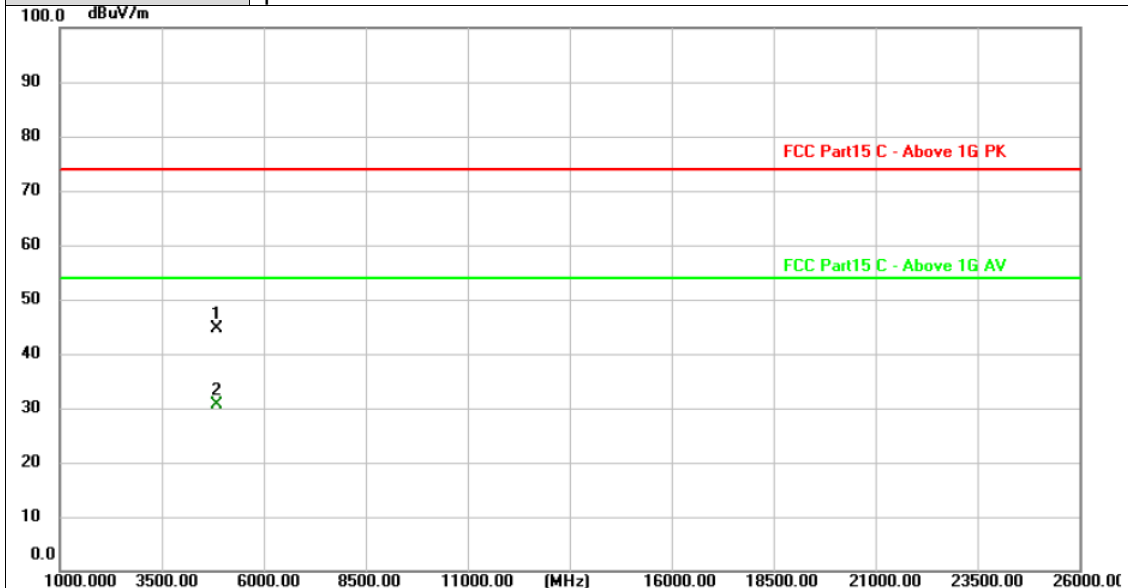

No.	Frequency (MHz)	Reading (dBuV)	Factor (dB/m)	Level (dBuV/m)	Limit (dBuV/m)	Margin (dB)	Detector
1	4843.815	41.41	3.23	44.64	74.00	-29.36	peak
2 *	4844.026	27.49	3.23	30.72	54.00	-23.28	AVG

Remarks:

- 1.Factor (dB/m) = Antenna Factor (dB/m)+Cable Factor (dB)-Pre-amplifier Factor
- 2.Margin value = Level -Limit value



Ant. Pol.	Horizontal
Test Mode:	TX 802.11n(HT40) Mode 2437MHz
Remark:	No report for the emission which more than 10 dB below the prescribed limit.

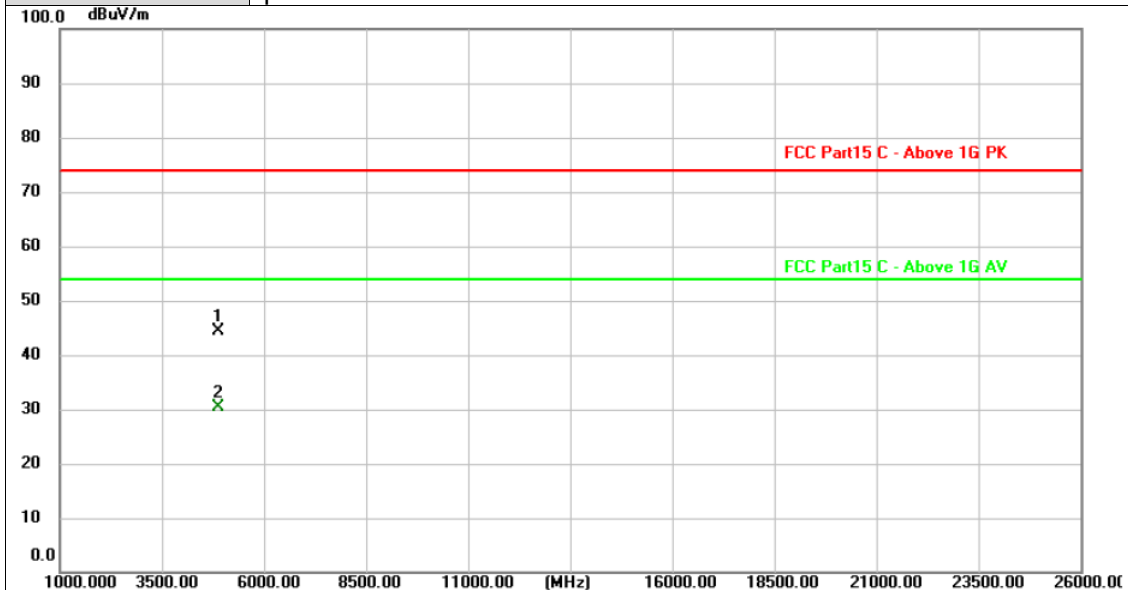

No.	Frequency (MHz)	Reading (dBuV)	Factor (dB/m)	Level (dBuV/m)	Limit (dBuV/m)	Margin (dB)	Detector
1	4873.541	41.16	3.32	44.48	74.00	-29.52	peak
2 *	4874.604	27.08	3.32	30.40	54.00	-23.60	AVG

Remarks:

- 1. Factor (dB/m) = Antenna Factor (dB/m)+Cable Factor (dB)-Pre-amplifier Factor
- 2. Margin value = Level -Limit value



Ant. Pol.	Vertical
Test Mode:	TX 802.11n(HT40) Mode 2437MHz
Remark:	No report for the emission which more than 10 dB below the prescribed limit.

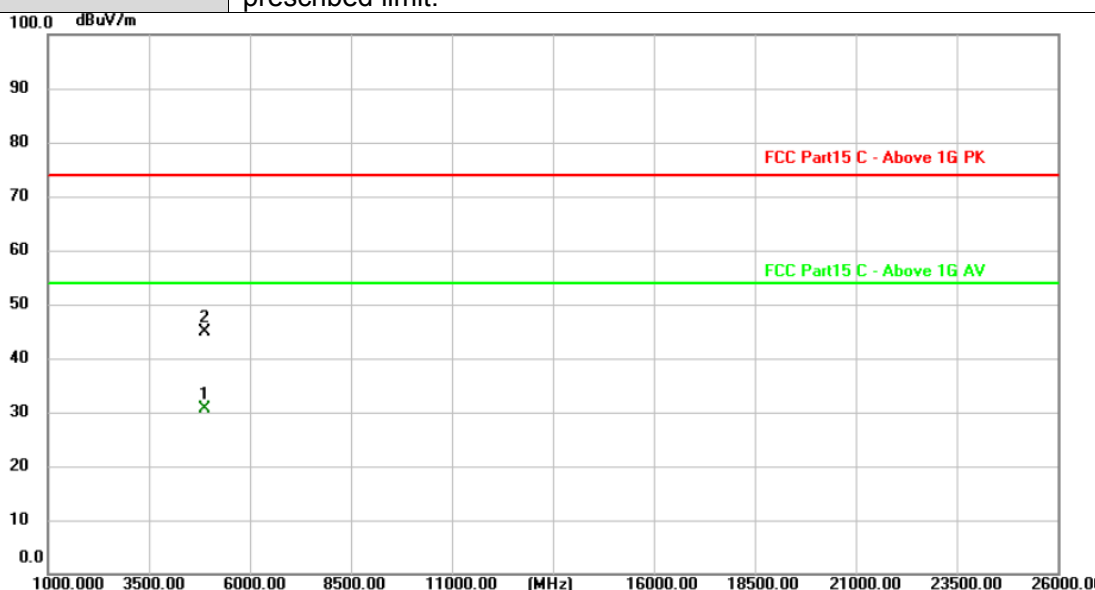

No.	Frequency (MHz)	Reading (dBuV)	Factor (dB/m)	Level (dBuV/m)	Limit (dBuV/m)	Margin (dB)	Detector
1 *	4873.321	27.43	3.32	30.75	54.00	-23.25	AVG
2	4874.013	41.44	3.32	44.76	74.00	-29.24	peak

Remarks:

- Factor (dB/m) = Antenna Factor (dB/m)+Cable Factor (dB)-Pre-amplifier Factor
- Margin value = Level -Limit value



Ant. Pol.	Horizontal
Test Mode:	TX 802.11n(HT40) Mode 2452MHz
Remark:	No report for the emission which more than 10 dB below the prescribed limit.

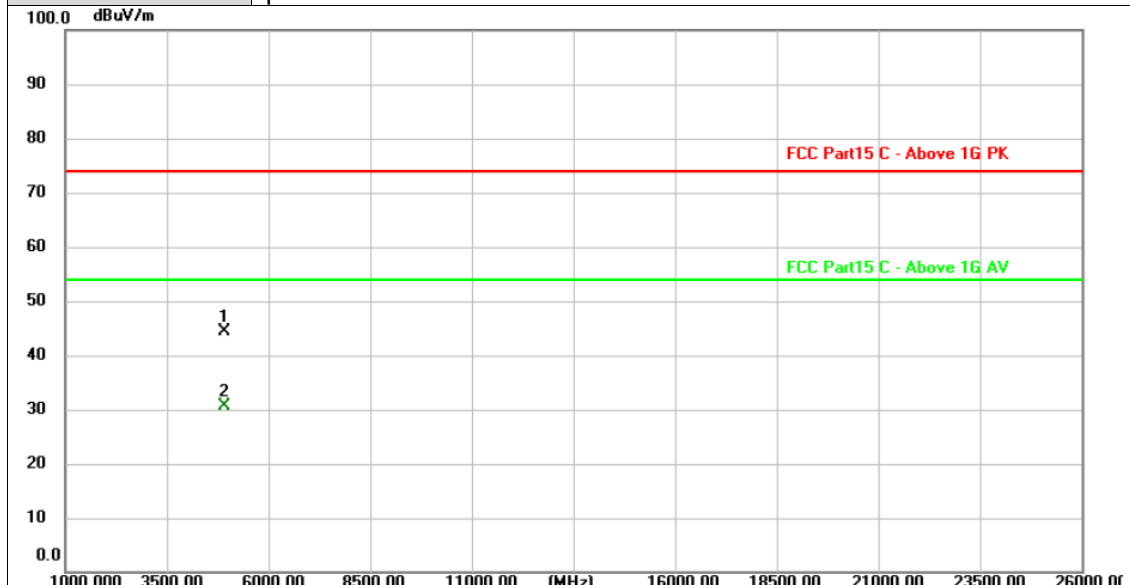

No.	Frequency (MHz)	Reading (dBuV)	Factor (dB/m)	Level (dBuV/m)	Limit (dBuV/m)	Margin (dB)	Detector
1	4903.860	41.10	3.40	44.50	74.00	-29.50	peak
2 *	4904.581	27.23	3.40	30.63	54.00	-23.37	AVG

Remarks:

- 1. Factor (dB/m) = Antenna Factor (dB/m)+Cable Factor (dB)-Pre-amplifier Factor
- 2. Margin value = Level -Limit value



Ant. Pol.	Vertical
Test Mode:	TX 802.11n(HT40) Mode 2452MHz
Remark:	No report for the emission which more than 10 dB below the prescribed limit.

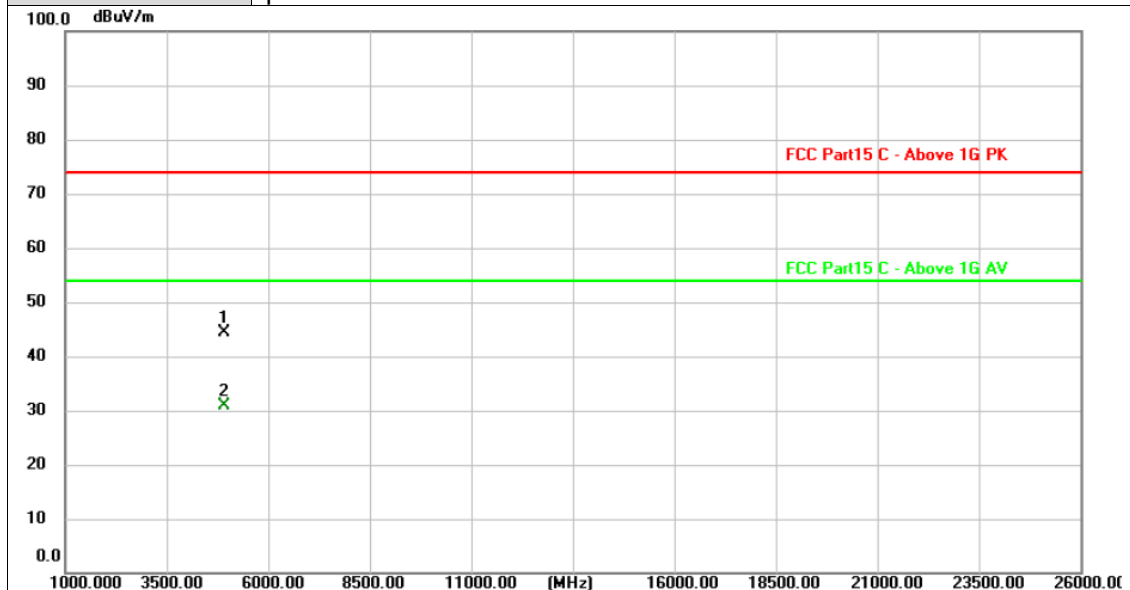

No.	Frequency (MHz)	Reading (dBuV)	Factor (dB/m)	Level (dBuV/m)	Limit (dBuV/m)	Margin (dB)	Detector
1	4903.314	41.05	3.40	44.45	74.00	-29.55	peak
2 *	4904.073	27.46	3.40	30.86	54.00	-23.14	AVG

Remarks:
 1. Factor (dB/m) = Antenna Factor (dB/m)+Cable Factor (dB)-Pre-amplifier Factor
 2. Margin value = Level -Limit value

3.3. Band Edge Emissions (Radiated)

Limit

FCC CFR Title 47 Part 15 Subpart C Section 15.247 (d)/ RSS 247 5.5:

Restricted Frequency Band (MHz)	(dBuV/m)(at 3m)	
	Peak	Average
2310 ~2390	74	54
2483.5 ~2500	74	54

Test Configuration

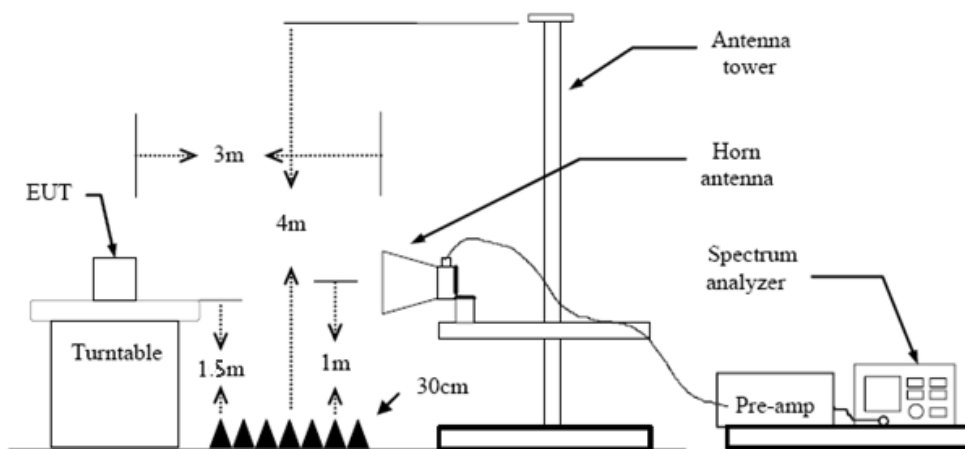

Test Procedure

1. The EUT was setup and tested according to ANSI C63.10:2013 requirements.
2. The EUT is placed on a turn table which is 1.5 meter above ground. The turn table is rotated 360 degrees to determine the position of the maximum emission level.
3. The EUT was positioned such that the distance from antenna to the EUT was 3 meters.
4. The antenna is scanned from 1 meter to 4 meters to find out the maximum emission level. This is repeated for both horizontal and vertical polarization of the antenna. In order to find the maximum emission, all of the interface cables were manipulated according to ANSI C63.10:2013 on radiated measurement.
5. The receiver set as follow:
 RBW=1MHz, VBW=3MHz Peak detector for Peak value.
 RBW=1MHz, VBW see note 1 with Peak Detector for Average Value.

Note 1: For measurements above 1 GHz the resolution bandwidth is set to 1 MHz, then the video bandwidth is set to 3 MHz for peak measurements and 1 MHz resolution bandwidth with 1/T video bandwidth with peak detector for average measurements. For the Duty Cycle please refer to clause 3.8 Duty Cycle.

Test Mode

Please refer to the clause 2.4.



Test Results

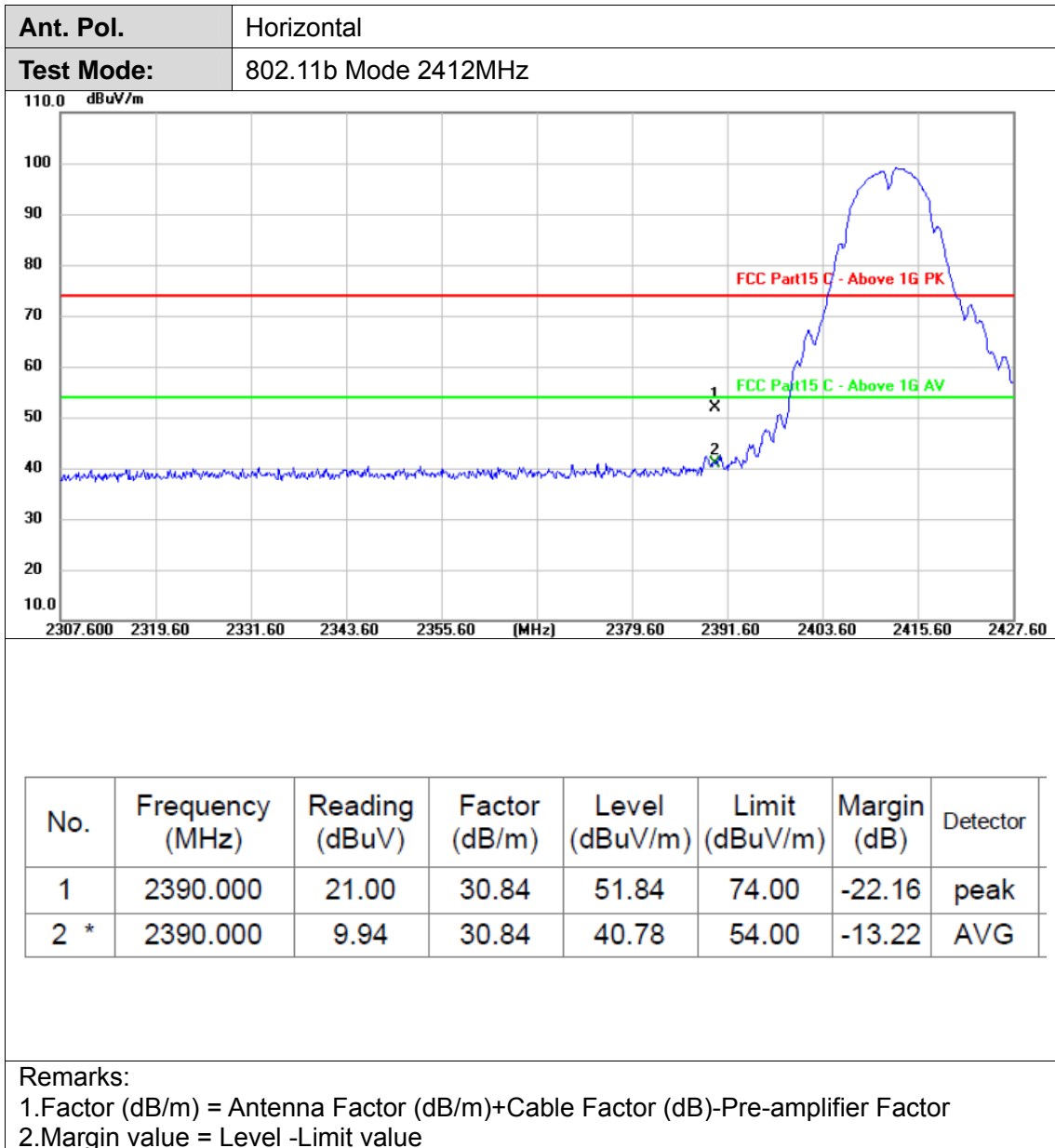



Ant. Pol.	Vertical
Test Mode:	802.11b Mode 2412MHz

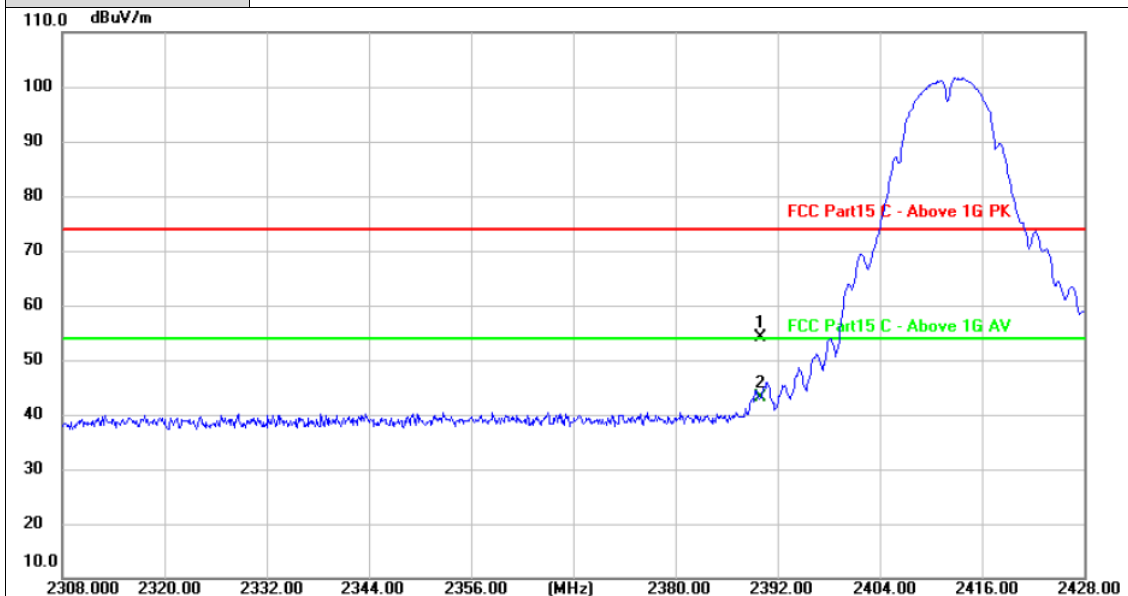

No.	Frequency (MHz)	Reading (dBuV)	Factor (dB/m)	Level (dBuV/m)	Limit (dBuV/m)	Margin (dB)	Detector
1	2390.000	23.21	30.84	54.05	74.00	-19.95	peak
2 *	2390.000	12.24	30.84	43.08	54.00	-10.92	AVG

Remarks:

- 1. Factor (dB/m) = Antenna Factor (dB/m) + Cable Factor (dB) - Pre-amplifier Factor
- 2. Margin value = Level - Limit value



Ant. Pol.	Horizontal
Test Mode:	802.11b Mode 2462 MHz

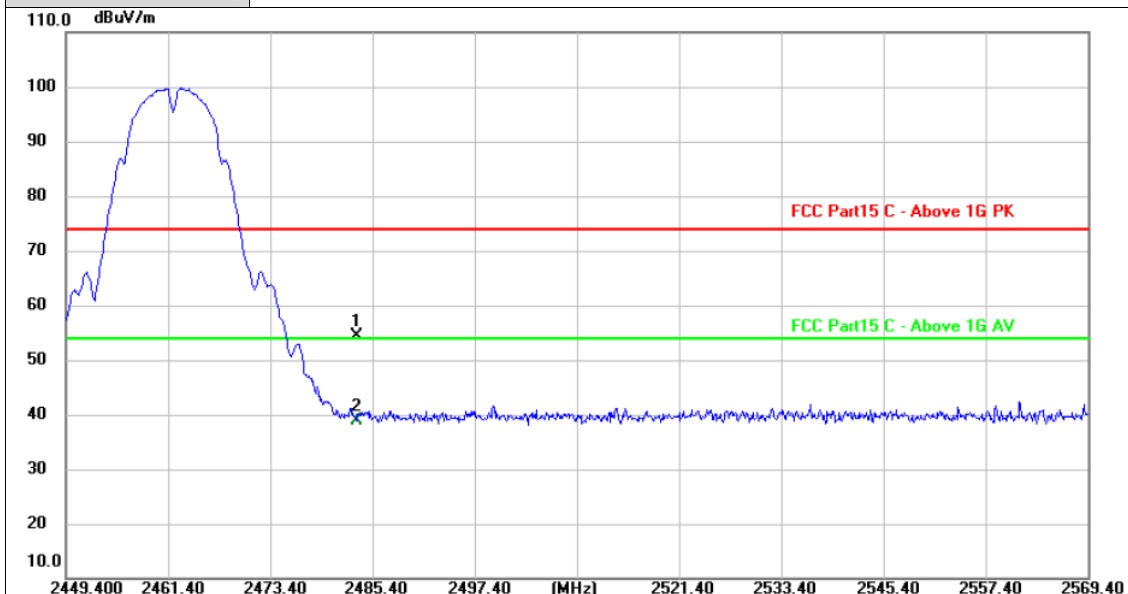

No.	Frequency (MHz)	Reading (dBuV)	Factor (dB/m)	Level (dBuV/m)	Limit (dBuV/m)	Margin (dB)	Detector
1	2483.500	23.09	31.24	54.33	74.00	-19.67	peak
2 *	2483.500	7.63	31.24	38.87	54.00	-15.13	AVG

Remarks:

- 1. Factor (dB/m) = Antenna Factor (dB/m)+Cable Factor (dB)-Pre-amplifier Factor
- 2. Margin value = Level -Limit value

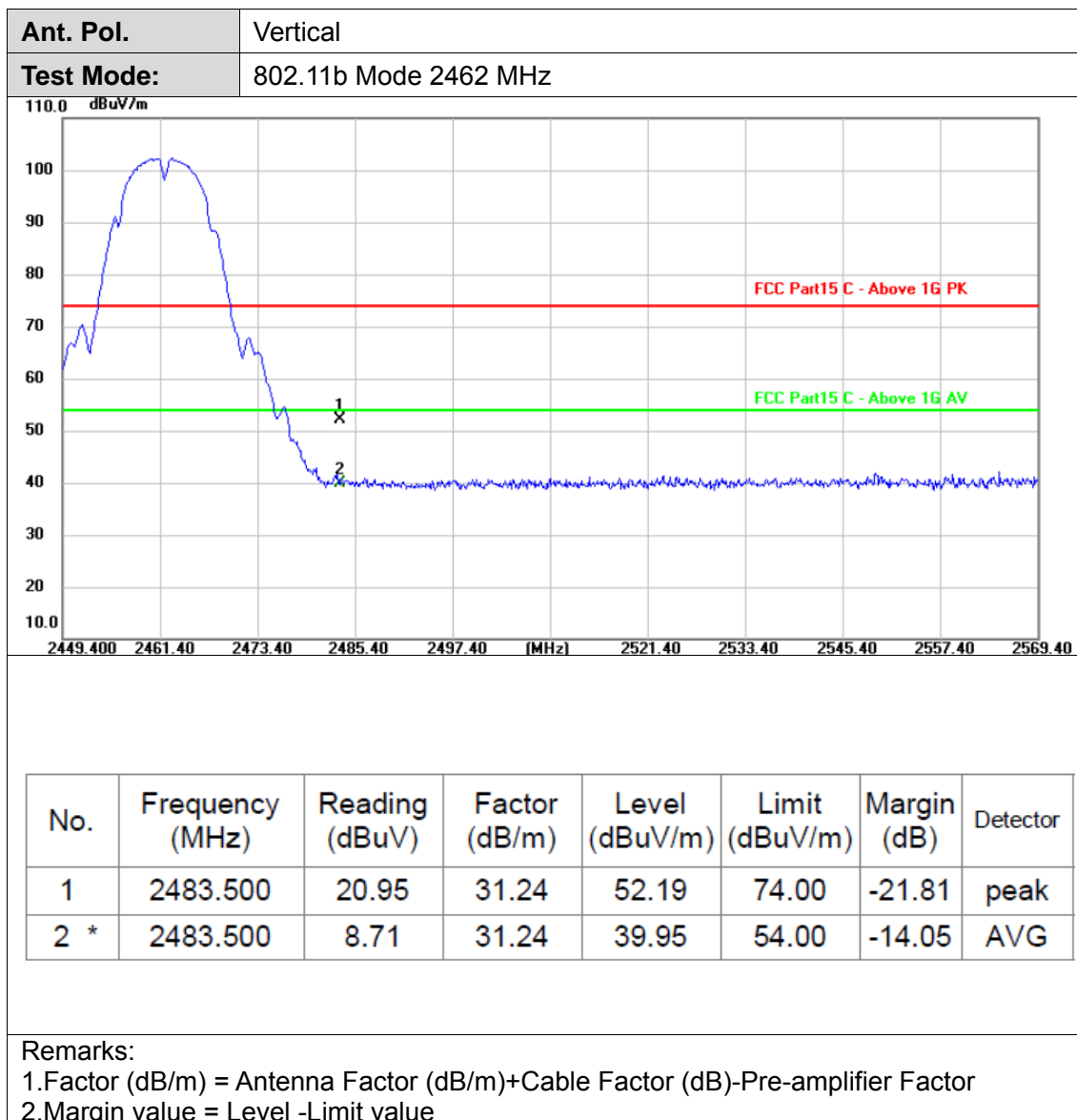



Ant. Pol.	Horizontal
Test Mode:	802.11g Mode 2412MHz

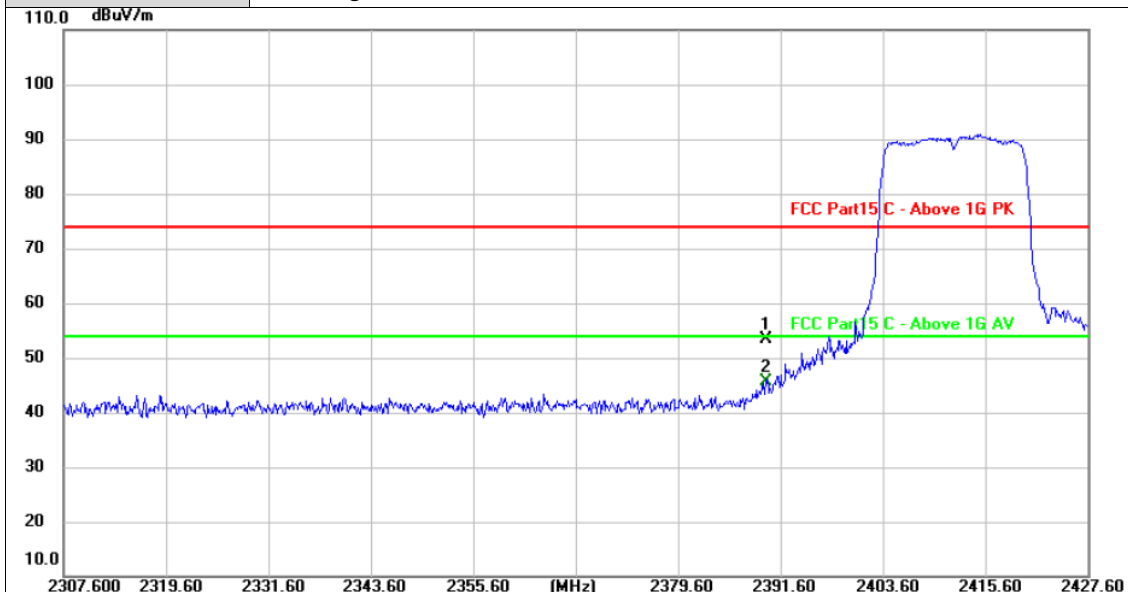

No.	Frequency (MHz)	Reading (dBuV)	Factor (dB/m)	Level (dBuV/m)	Limit (dBuV/m)	Margin (dB)	Detector
1	2390.000	22.62	30.84	53.46	74.00	-20.54	peak
2 *	2390.000	14.82	30.84	45.66	54.00	-8.34	AVG

Remarks:

- 1. Factor (dB/m) = Antenna Factor (dB/m)+Cable Factor (dB)-Pre-amplifier Factor
- 2. Margin value = Level -Limit value



Ant. Pol.	Vertical
Test Mode:	802.11g Mode 2412MHz

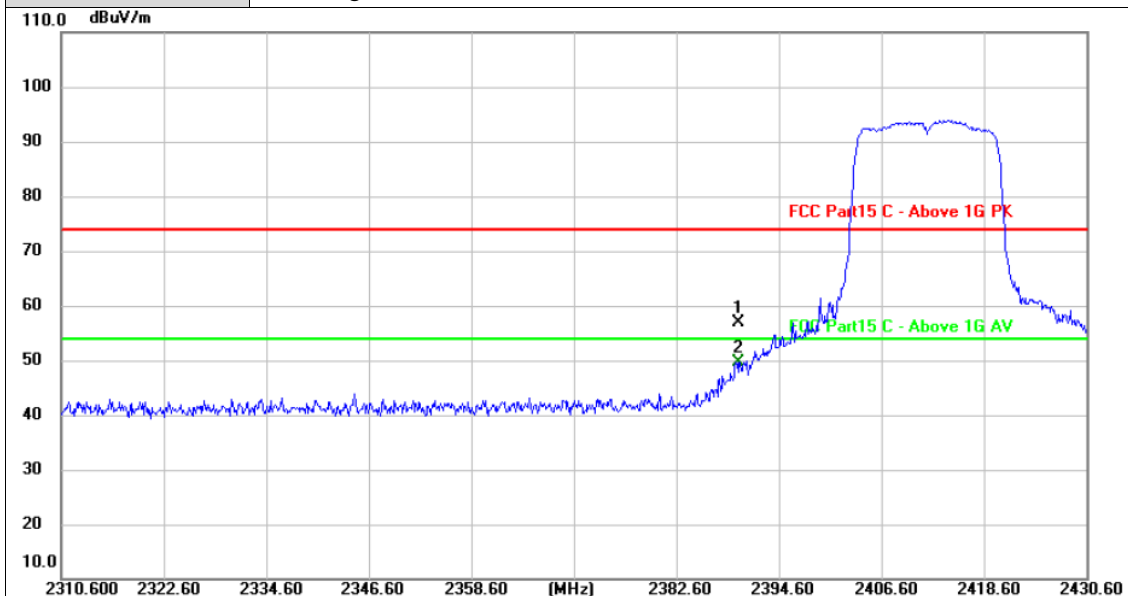

No.	Frequency (MHz)	Reading (dBuV)	Factor (dB/m)	Level (dBuV/m)	Limit (dBuV/m)	Margin (dB)	Detector
1	2390.000	25.99	30.84	56.83	74.00	-17.17	peak
2 *	2390.000	18.81	30.84	49.65	54.00	-4.35	AVG

Remarks:

- 1.Factor (dB/m) = Antenna Factor (dB/m)+Cable Factor (dB)-Pre-amplifier Factor
- 2.Margin value = Level -Limit value



Ant. Pol.	Horizontal
Test Mode:	802.11g Mode 2462MHz

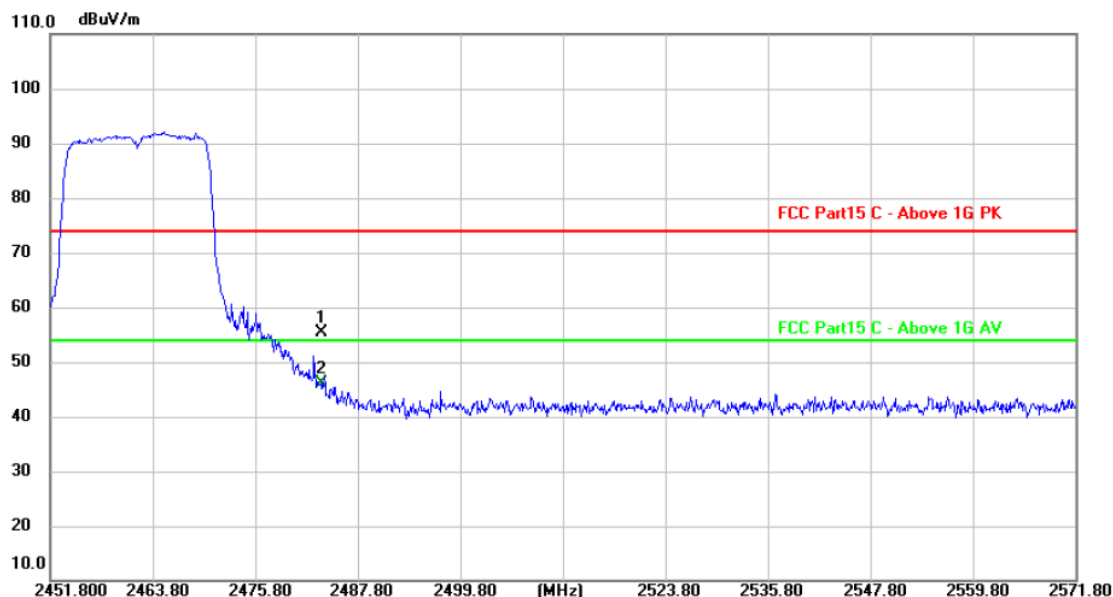

No.	Frequency (MHz)	Reading (dBuV)	Factor (dB/m)	Level (dBuV/m)	Limit (dBuV/m)	Margin (dB)	Detector
1	2483.500	24.15	31.24	55.39	74.00	-18.61	peak
2 *	2483.500	14.86	31.24	46.10	54.00	-7.90	AVG

Remarks:

- 1.Factor (dB/m) = Antenna Factor (dB/m)+Cable Factor (dB)-Pre-amplifier Factor
- 2.Margin value = Level -Limit value



Ant. Pol.	Vertical
Test Mode:	802.11g Mode 2462MHz

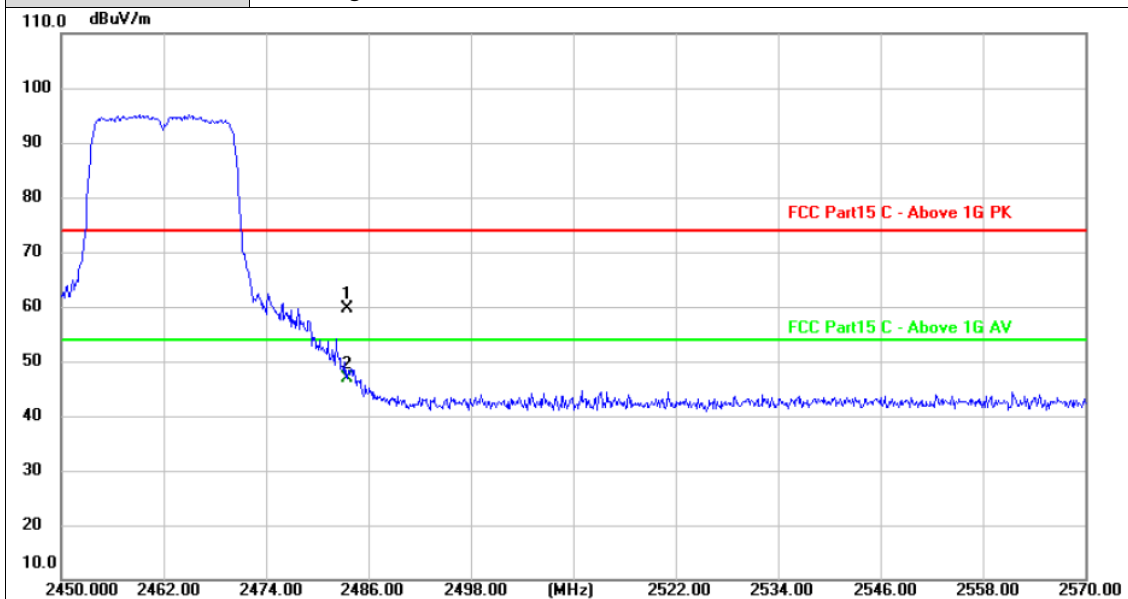

No.	Frequency (MHz)	Reading (dBuV)	Factor (dB/m)	Level (dBuV/m)	Limit (dBuV/m)	Margin (dB)	Detector
1	2483.500	28.42	31.24	59.66	74.00	-14.34	peak
2 *	2483.500	15.64	31.24	46.88	54.00	-7.12	AVG

Remarks:

- 1. Factor (dB/m) = Antenna Factor (dB/m)+Cable Factor (dB)-Pre-amplifier Factor
- 2. Margin value = Level -Limit value



Ant. Pol.	Horizontal
Test Mode:	802.11n(HT20) Mode 2412MHz

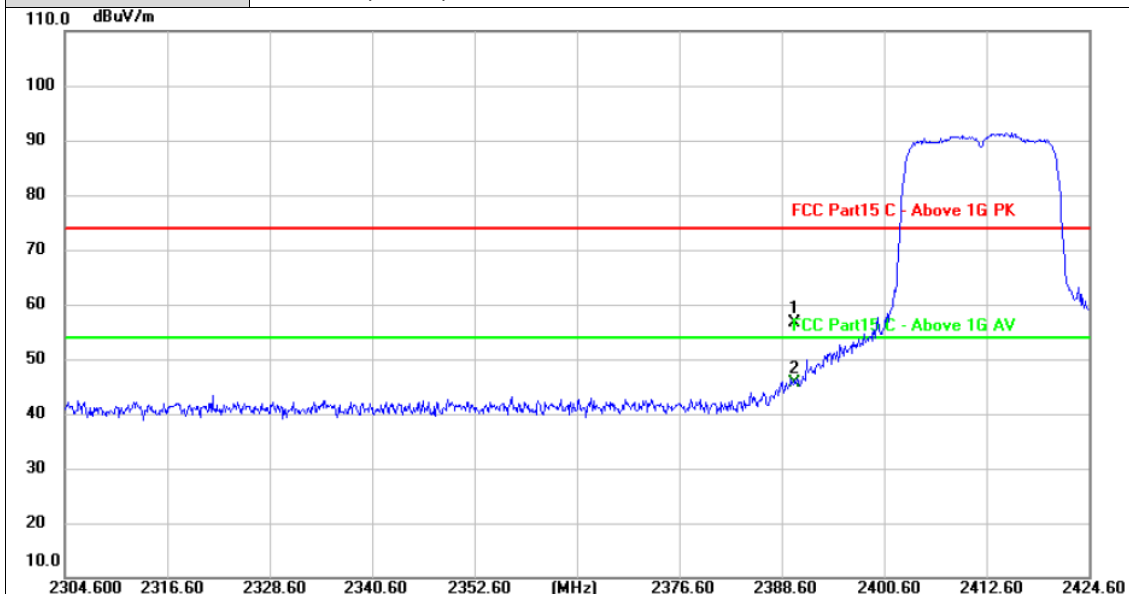

No.	Frequency (MHz)	Reading (dBuV)	Factor (dB/m)	Level (dBuV/m)	Limit (dBuV/m)	Margin (dB)	Detector
1	2390.000	25.70	30.84	56.54	74.00	-17.46	peak
2 *	2390.000	14.77	30.84	45.61	54.00	-8.39	AVG

Remarks:

- 1.Factor (dB/m) = Antenna Factor (dB/m)+Cable Factor (dB)-Pre-amplifier Factor
- 2.Margin value = Level -Limit value



Ant. Pol.	Vertical
Test Mode:	802.11n(HT20) Mode 2412MHz

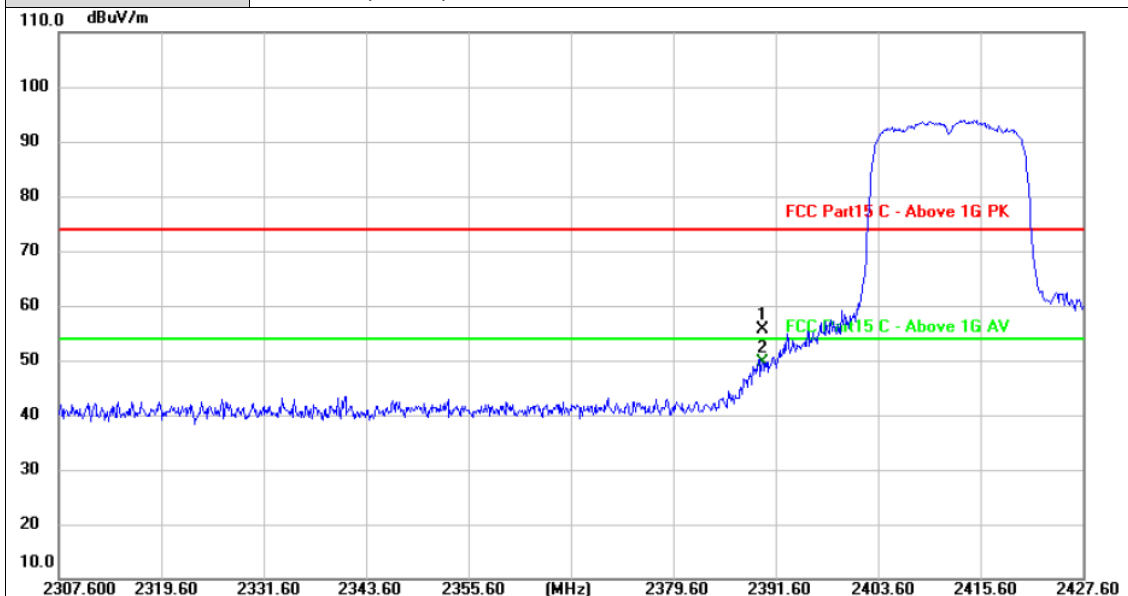

No.	Frequency (MHz)	Reading (dBuV)	Factor (dB/m)	Level (dBuV/m)	Limit (dBuV/m)	Margin (dB)	Detector
1	2390.000	24.89	30.84	55.73	74.00	-18.27	peak
2 *	2390.000	18.68	30.84	49.52	54.00	-4.48	AVG

Remarks:

1. Factor (dB/m) = Antenna Factor (dB/m)+Cable Factor (dB)-Pre-amplifier Factor
2. Margin value = Level -Limit value



Ant. Pol.	Horizontal
Test Mode:	802.11n(HT20) Mode 2462MHz

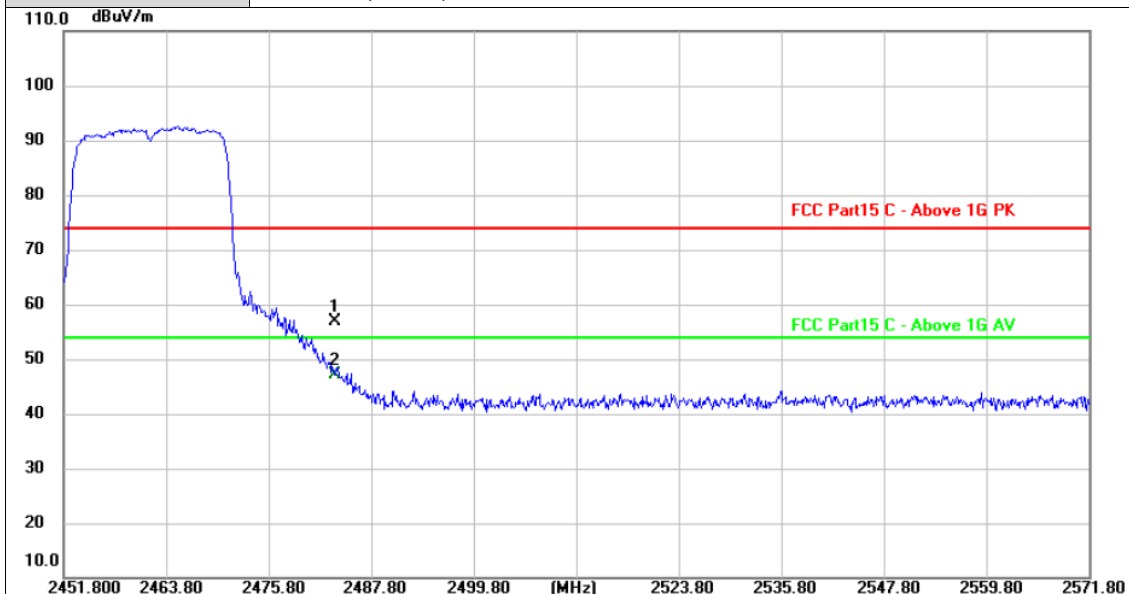

No.	Frequency (MHz)	Reading (dBuV)	Factor (dB/m)	Level (dBuV/m)	Limit (dBuV/m)	Margin (dB)	Detector
1	2483.500	25.74	31.24	56.98	74.00	-17.02	peak
2 *	2483.500	15.92	31.24	47.16	54.00	-6.84	AVG

Remarks:

- 1.Factor (dB/m) = Antenna Factor (dB/m)+Cable Factor (dB)-Pre-amplifier Factor
- 2.Margin value = Level -Limit value



Ant. Pol.	Vertical
Test Mode:	802.11n(HT20) Mode 2462MHz

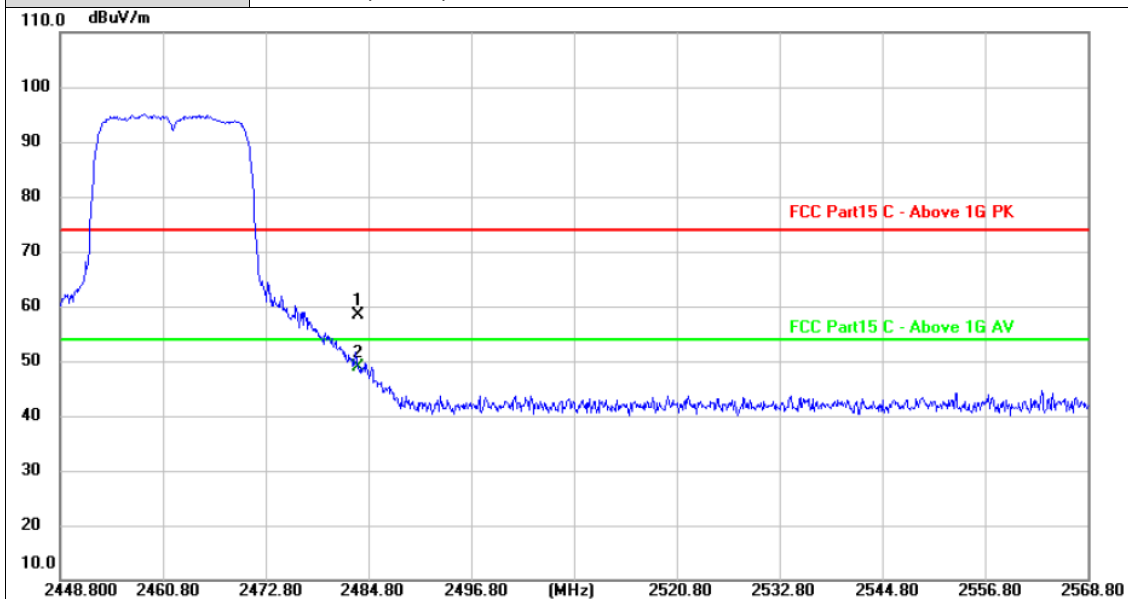

No.	Frequency (MHz)	Reading (dBuV)	Factor (dB/m)	Level (dBuV/m)	Limit (dBuV/m)	Margin (dB)	Detector
1	2483.500	27.22	31.24	58.46	74.00	-15.54	peak
2 *	2483.500	17.73	31.24	48.97	54.00	-5.03	AVG

Remarks:

- 1. Factor (dB/m) = Antenna Factor (dB/m)+Cable Factor (dB)-Pre-amplifier Factor
- 2. Margin value = Level -Limit value

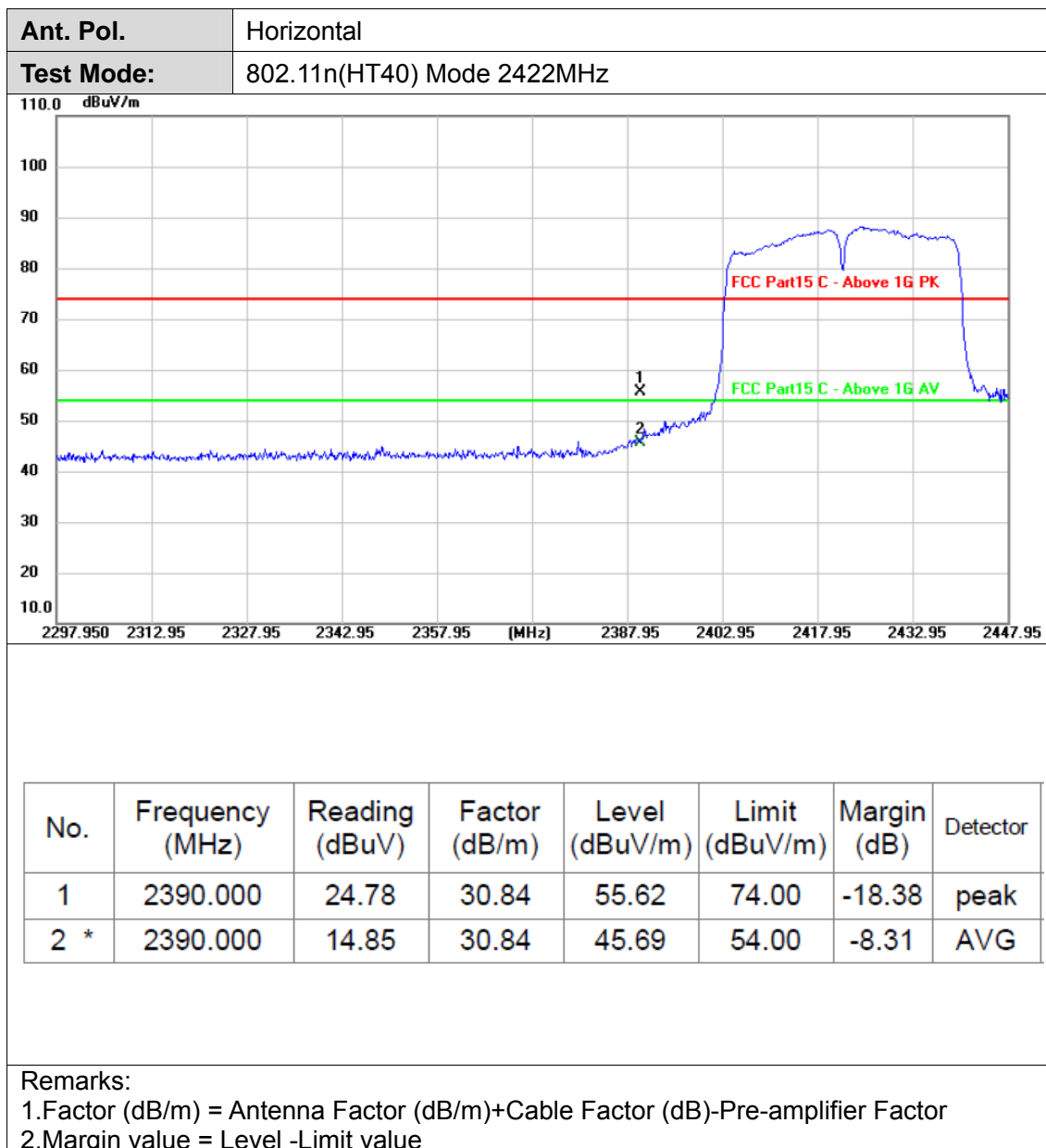



Ant. Pol.	Vertical
Test Mode:	802.11n(HT40) Mode 2422MHz

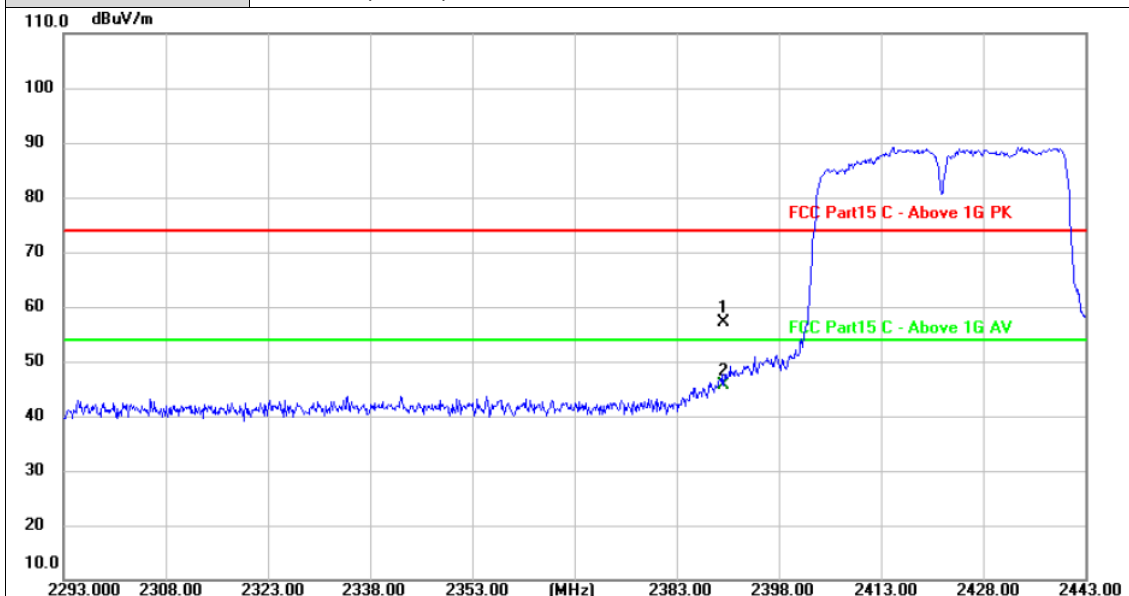

No.	Frequency (MHz)	Reading (dBuV)	Factor (dB/m)	Level (dBuV/m)	Limit (dBuV/m)	Margin (dB)	Detector
1	2390.000	26.39	30.84	57.23	74.00	-16.77	peak
2 *	2390.000	14.73	30.84	45.57	54.00	-8.43	AVG

Remarks:

- 1. Factor (dB/m) = Antenna Factor (dB/m)+Cable Factor (dB)-Pre-amplifier Factor
- 2. Margin value = Level -Limit value



Ant. Pol.	Horizontal
Test Mode:	802.11n(HT40) Mode 2452MHz

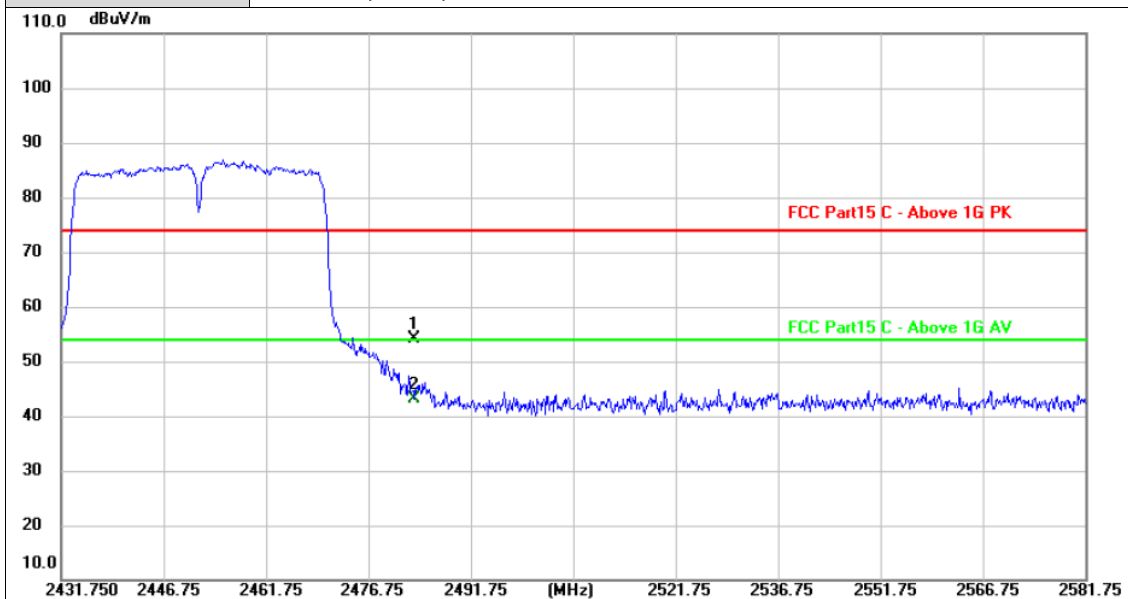

No.	Frequency (MHz)	Reading (dBuV)	Factor (dB/m)	Level (dBuV/m)	Limit (dBuV/m)	Margin (dB)	Detector
1	2483.500	22.77	31.24	54.01	74.00	-19.99	peak
2 *	2483.500	11.90	31.24	43.14	54.00	-10.86	AVG

Remarks:

- 1.Factor (dB/m) = Antenna Factor (dB/m)+Cable Factor (dB)-Pre-amplifier Factor
- 2.Margin value = Level -Limit value



Ant. Pol.	Vertical
Test Mode:	802.11n(HT40) Mode 2452MHz

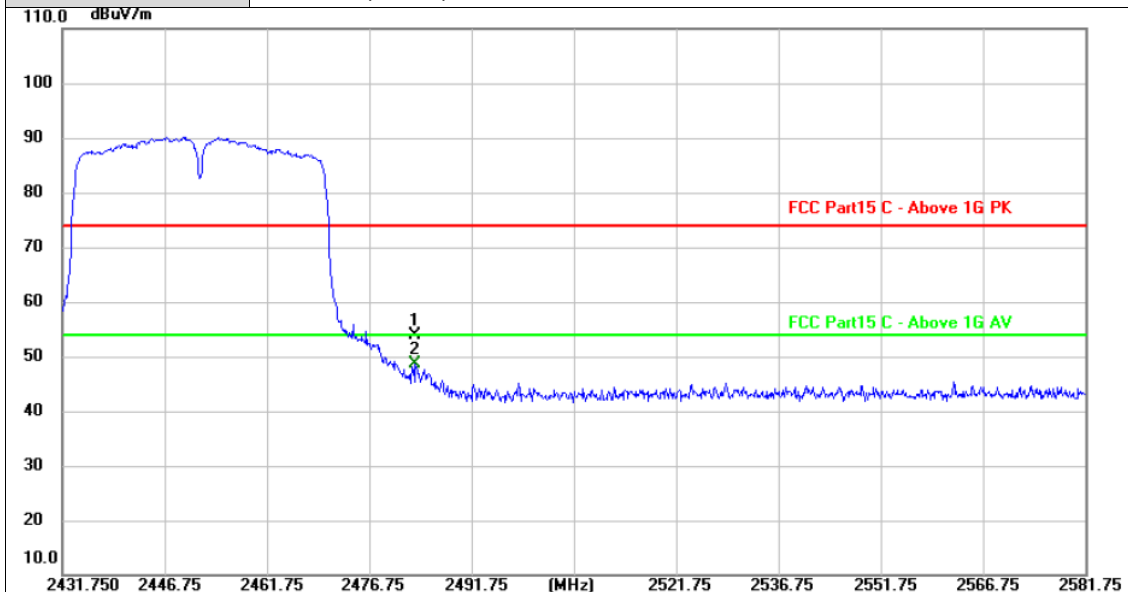

No.	Frequency (MHz)	Reading (dBuV)	Factor (dB/m)	Level (dBuV/m)	Limit (dBuV/m)	Margin (dB)	Detector
1	2483.500	22.67	31.24	53.91	74.00	-20.09	peak
2 *	2483.500	17.27	31.24	48.51	54.00	-5.49	AVG

Remarks:

- 1.Factor (dB/m) = Antenna Factor (dB/m)+Cable Factor (dB)-Pre-amplifier Factor
- 2.Margin value = Level -Limit value



3.4. Band edge and Spurious Emissions (Conducted)

Limit

FCC CFR Title 47 Part 15 Subpart C Section 15.247 (d): In any 100 kHz bandwidth outside the frequency band in which the spread spectrum intentional radiator is operating, the radio frequency power that is produced by the intentional radiator shall be at least 20 dB below that in the 100 kHz bandwidth within the band that contains the highest level of the desired power, based on either an RF conducted or a radiated measurement.

Test Configuration

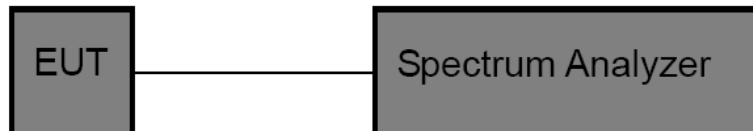

Test Procedure

1. The transmitter output was connected to the spectrum analyzer through an attenuator, the path loss was compensated to the results for each measurement.
2. Set to the maximum power setting and enable the EUT transmit continuously
3. Use the following spectrum analyzer settings:
RBW = 100 kHz, VBW \geq RBW, scan up through 10th harmonic.
Sweep = auto, Detector function = peak, Trace = max hold
4. Measure and record the results in the test report.

Test Mode

Please refer to the clause 2.4.

Test Results

**(1) Band edge Conducted Test**

Test Mode	Channel	Ref Level[dBm]	Result [dBm]	Limit [dBm]	Verdict
802.11b	2412	9.26	-34.73	<=-10.74	PASS
	2462	8.53	-54.67	<=-11.47	PASS
802.11g	2412	2.76	-32.61	<=-17.24	PASS
	2462	2.53	-41.29	<=-17.47	PASS
802.11n(HT20)	2412	2.61	-32.16	<=-17.39	PASS
	2462	2.07	-43.88	<=-17.93	PASS
802.11n(HT40)	2422	-1.66	-39.06	<=-21.66	PASS
	2452	-1.69	-46.49	<=-21.69	PASS



802.11b_Low_2412

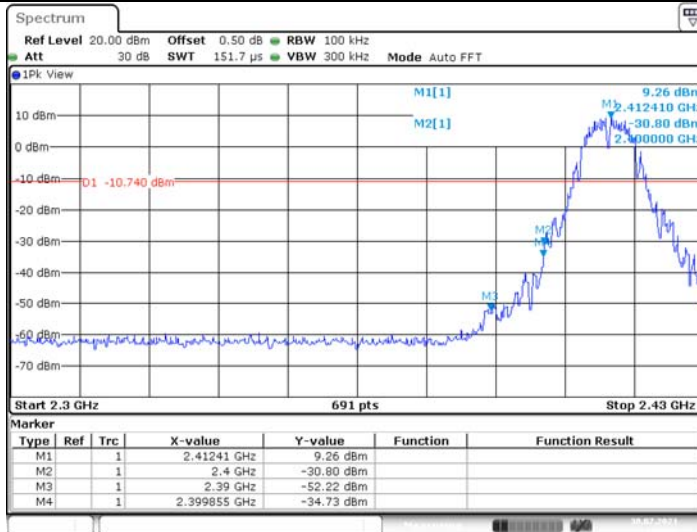

Date: 30.JUL.2021 11:38:35

802.11b_High_2462

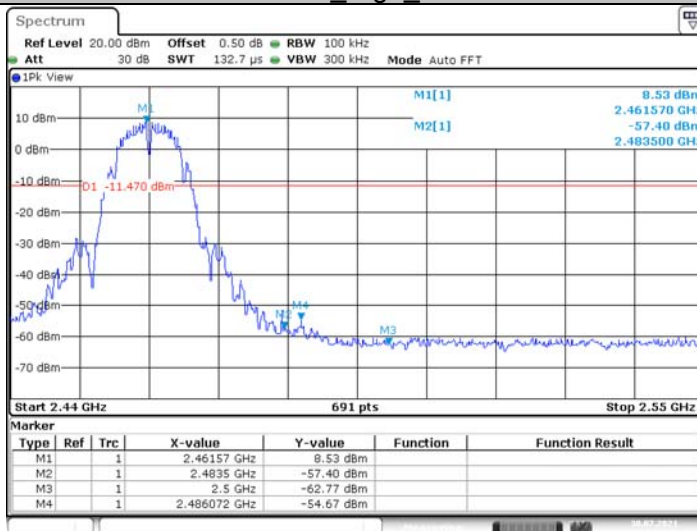

Date: 30.JUL.2021 11:44:17

802.11g_Low_2412

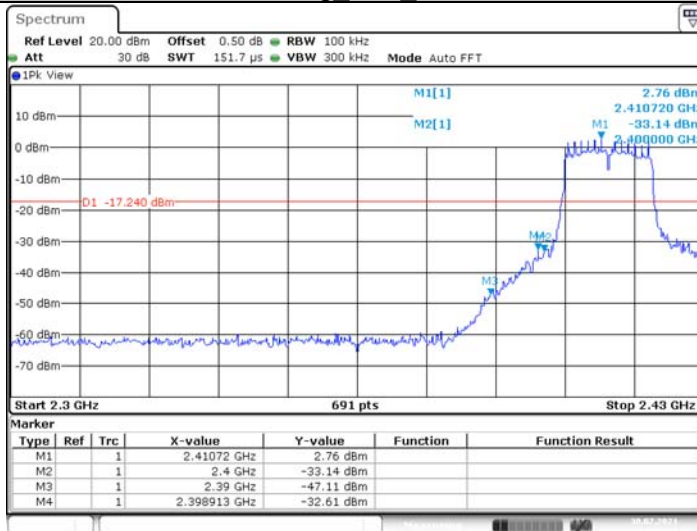

Date: 30.JUL.2021 11:50:10

802.11g_High_2462

CTC Laboratories, Inc.

1-2/F., Building 2, Jiaquan Building, Guanlan High-Tech Park, Shenzhen, Guangdong, China
Tel.: (86)755-27521059 Fax: (86)755-27521011 Http://www.sz-ctc.org.cn



For anti-fake verification, please visit the official website of Certification and Accreditation Administration of the People's Republic of China : yz.cnca.cn

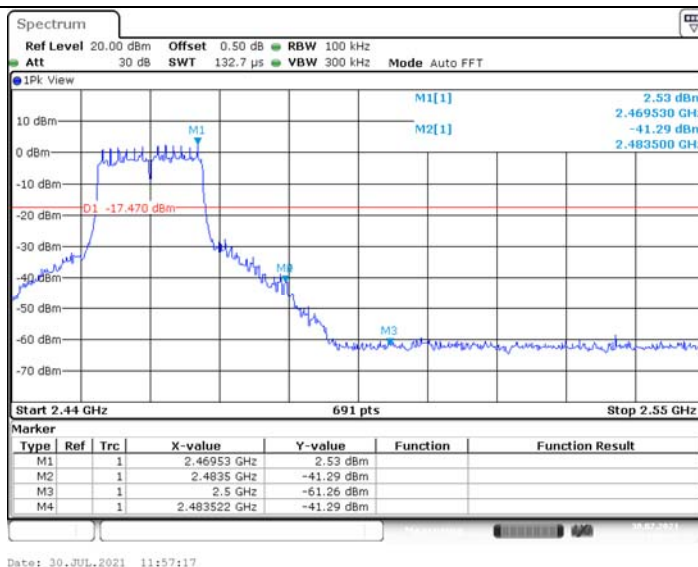

802.11n(HT20) Low 2412

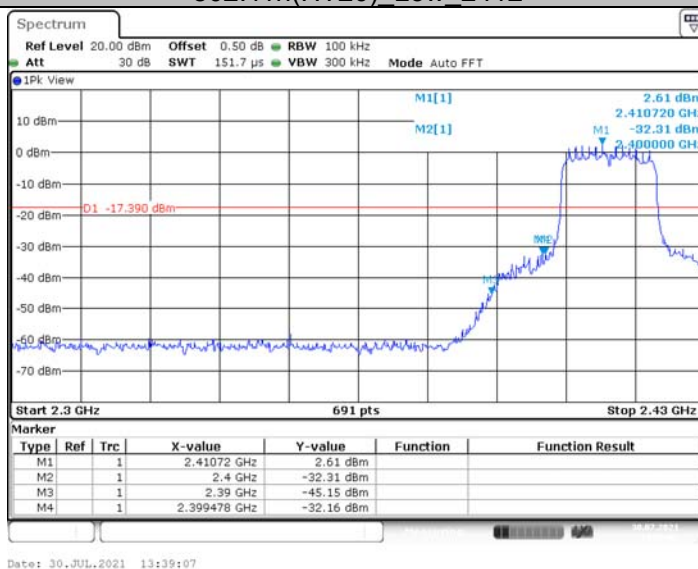

802.11n(HT20) High 2462

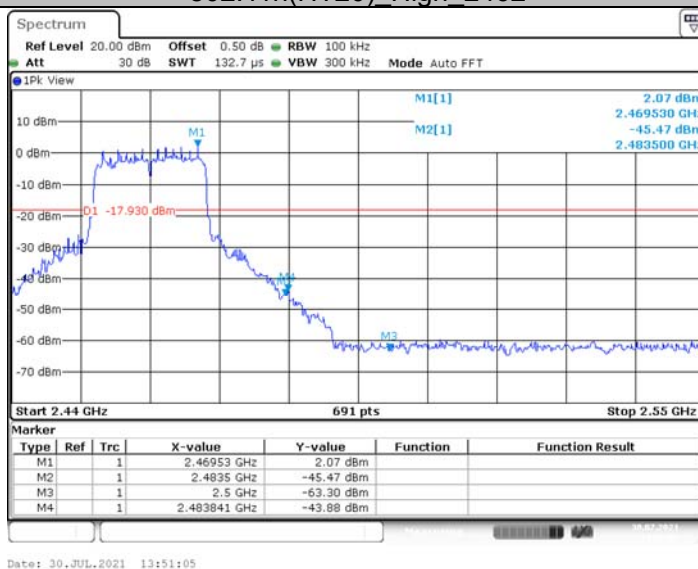

802.11n(HT40) Low 2422

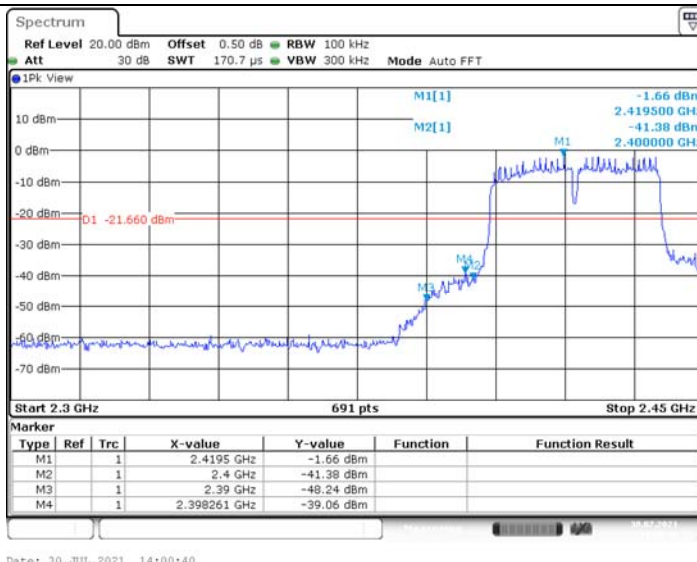

802.11n(HT40) High 2452

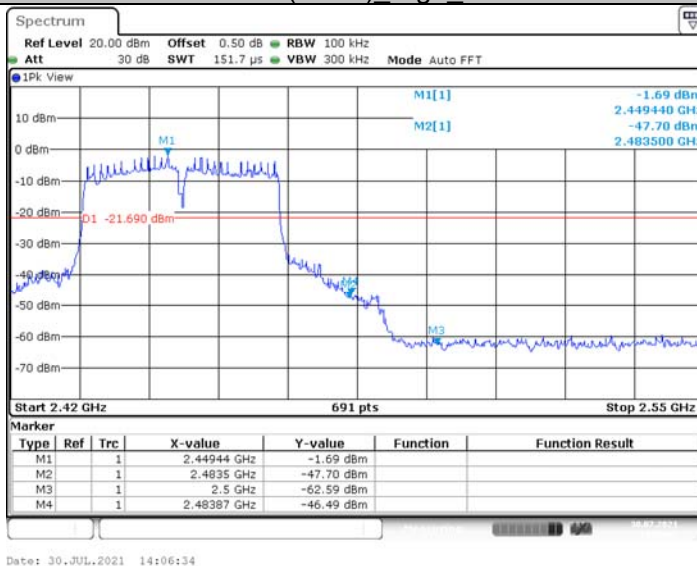



(2) Conducted Spurious Emissions Test

Test Mode	Channel	Freq Range [Mhz]	Ref Level [dBm]	Result [dBm]	Limit [dBm]	Verdict
802.11b	2412	Reference	9.64	9.64	---	PASS
		30~1000	30~1000	-70.88	<=-10.36	PASS
		1000~26500	1000~26500	-28.39	<=-10.36	PASS
	2437	Reference	10.89	10.89	---	PASS
		30~1000	30~1000	-69.77	<=-9.11	PASS
		1000~26500	1000~26500	-45.50	<=-9.11	PASS
	2462	Reference	8.93	8.93	---	PASS
		30~1000	30~1000	-63.55	<=-11.07	PASS
		1000~26500	1000~26500	-46.59	<=-11.07	PASS
802.11g	2412	Reference	2.77	2.77	---	PASS
		30~1000	30~1000	-69.40	<=-17.23	PASS
		1000~26500	1000~26500	-29.64	<=-17.23	PASS
	2437	Reference	4.56	4.56	---	PASS
		30~1000	30~1000	-70.95	<=-15.44	PASS
		1000~26500	1000~26500	-46.73	<=-15.44	PASS
	2462	Reference	2.21	2.21	---	PASS
		30~1000	30~1000	-70.92	<=-17.79	PASS
		1000~26500	1000~26500	-45.74	<=-17.79	PASS
802.11n(HT20)	2412	Reference	2.65	2.65	---	PASS
		30~1000	30~1000	-70.45	<=-17.35	PASS
		1000~26500	1000~26500	-31.41	<=-17.35	PASS
	2437	Reference	4.28	4.28	---	PASS
		30~1000	30~1000	-71.15	<=-15.72	PASS
		1000~26500	1000~26500	-46.69	<=-15.72	PASS
	2462	Reference	1.99	1.99	---	PASS
		30~1000	30~1000	-71.00	<=-18.01	PASS
		1000~26500	1000~26500	-45.74	<=-18.01	PASS
802.11n(HT40)	2422	Reference	-1.46	-1.46	---	PASS
		30~1000	30~1000	-70.81	<=-21.46	PASS
		1000~26500	1000~26500	-38.72	<=-21.46	PASS
	2437	Reference	-0.52	-0.52	---	PASS
		30~1000	30~1000	-71.12	<=-20.52	PASS
		1000~26500	1000~26500	-42.48	<=-20.52	PASS
	2452	Reference	-1.65	-1.65	---	PASS
		30~1000	30~1000	-71.42	<=-21.65	PASS
		1000~26500	1000~26500	-46.42	<=-21.65	PASS



802.11b_2412_0~Reference



Date: 30.JUL.2021 11:39:38

802.11b_2412_30~1000

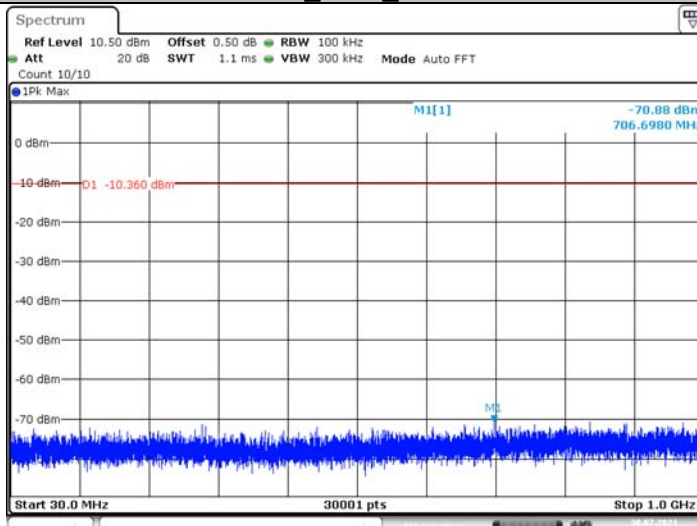

Date: 30.JUL.2021 11:39:48

802.11b_2412_1000~26500

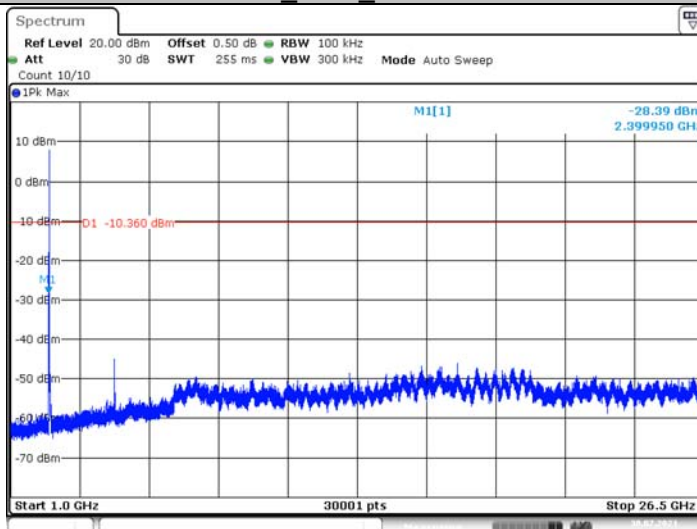

Date: 30.JUL.2021 11:40:15

802.11b_2437_0~Reference

CTC Laboratories, Inc.

1-2/F., Building 2, Jiaquan Building, Guanlan High-Tech Park, Shenzhen, Guangdong, China

Tel.: (86)755-27521059

Fax: (86)755-27521011

Http://www.sz-ctc.org.cn



For anti-fake verification, please visit the official website of Certification and Accreditation Administration of the People's Republic of China : yz.cnca.cn

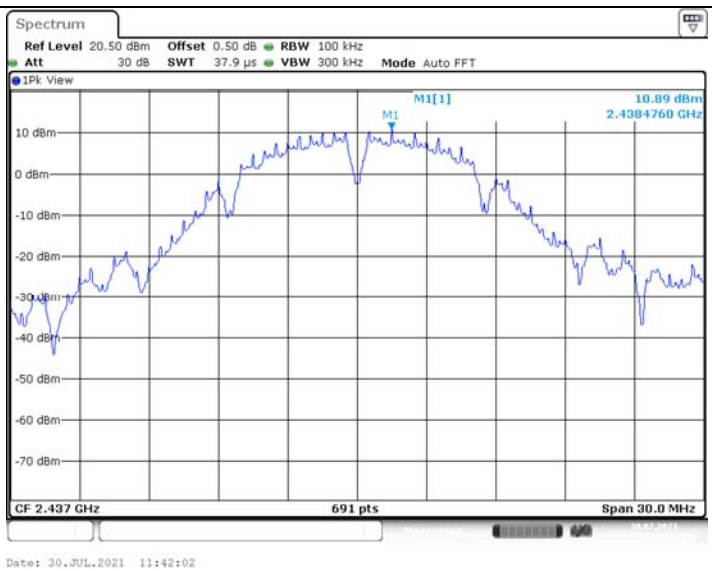

802.11b 2437 30~1000

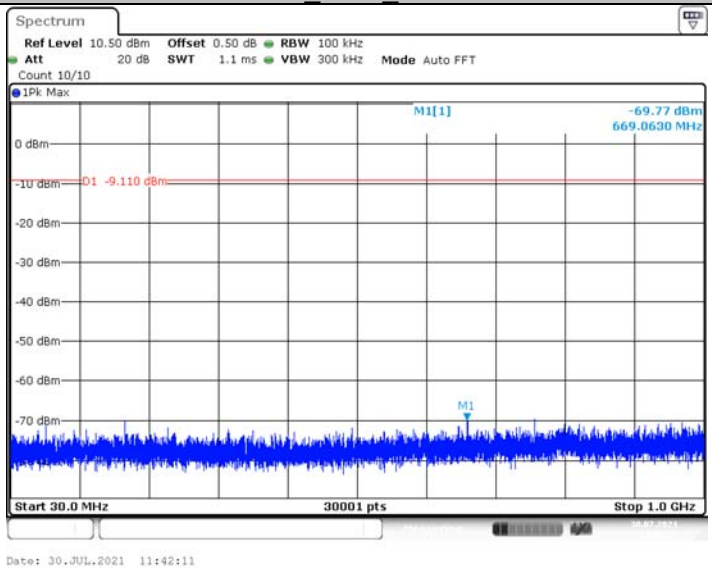

802.11b 2437 1000~26500

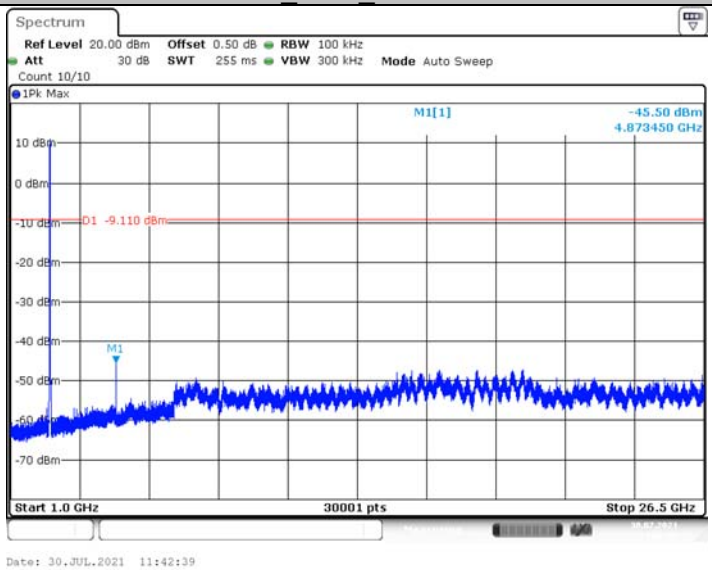

802.11b_2462_0~Reference

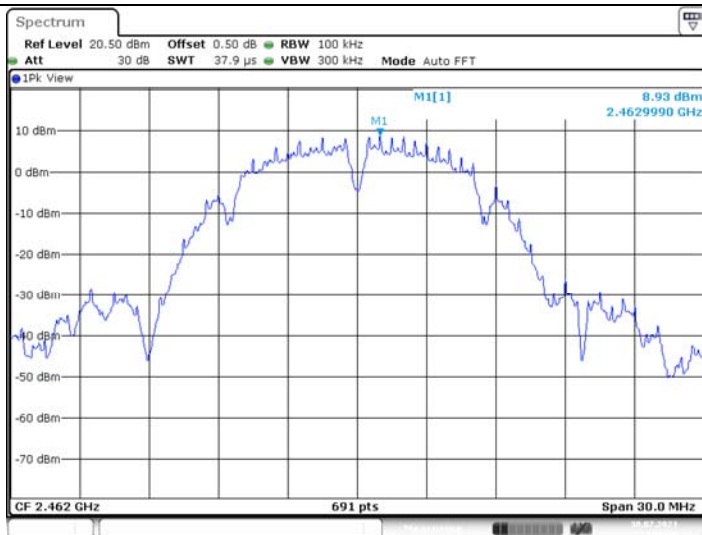

802.11b 2462 30~1000

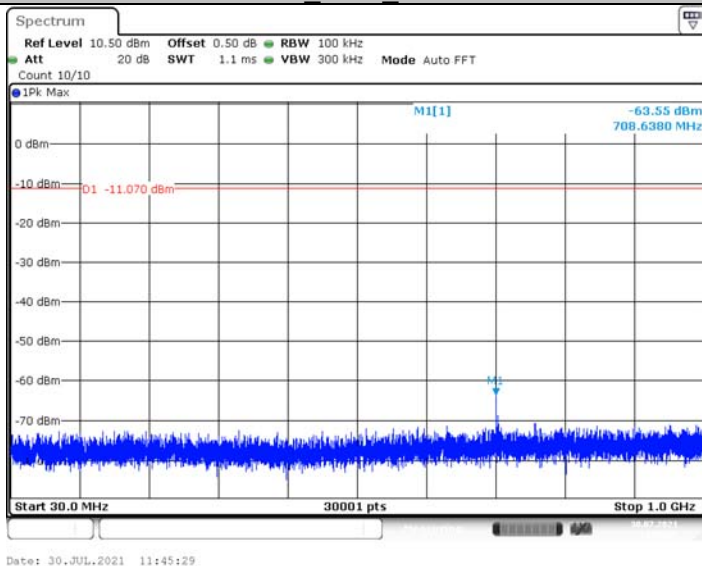

802.11b 2462 1000~26500

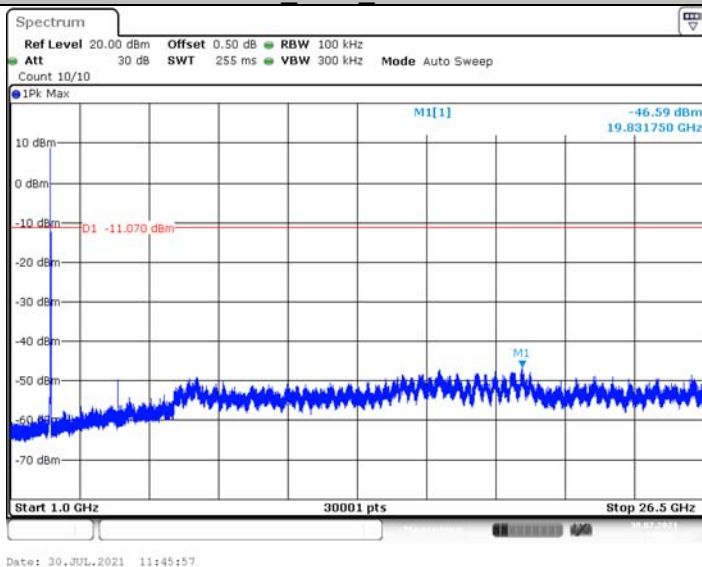

802.11g 2412 0~Reference

CTC Laboratories, Inc.

1-2/F., Building 2, Jiaquan Building, Guanlan High-Tech Park, Shenzhen, Guangdong, China

Tel.: (86)755-27521059

Fax: (86)755-27521011

Http://www.sz-ctc.org.cn



For anti-fake verification, please visit the official website of Certification and Accreditation Administration of the People's Republic of China : yz.cnca.cn

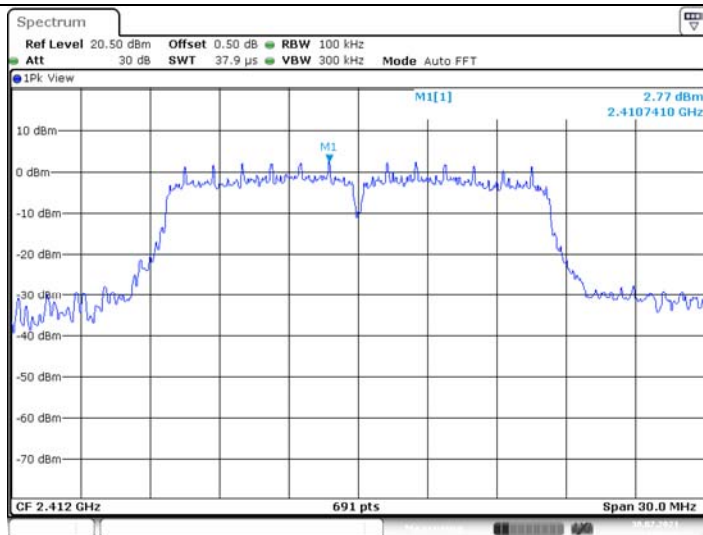

802.11g 2412 30~1000

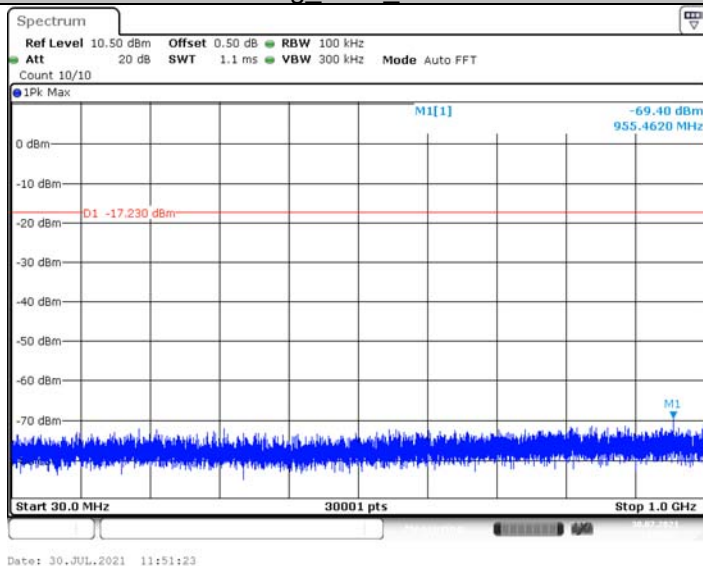

802.11g 2412 1000~26500

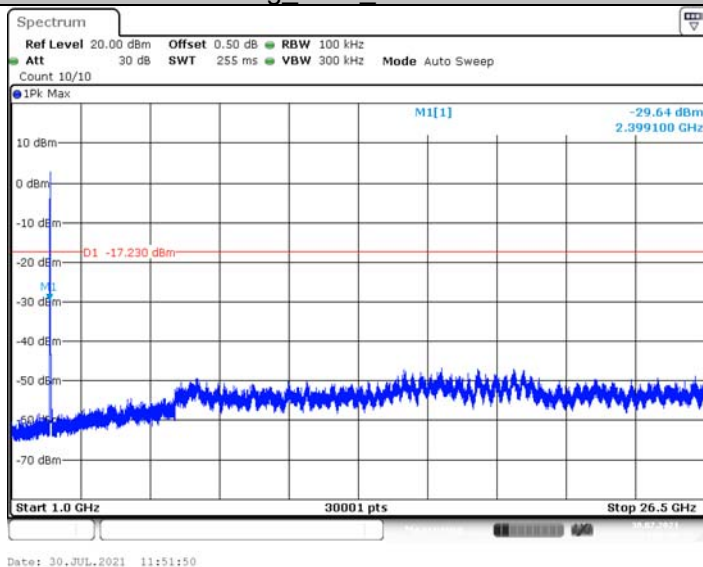

802.11g 2437_0~Reference

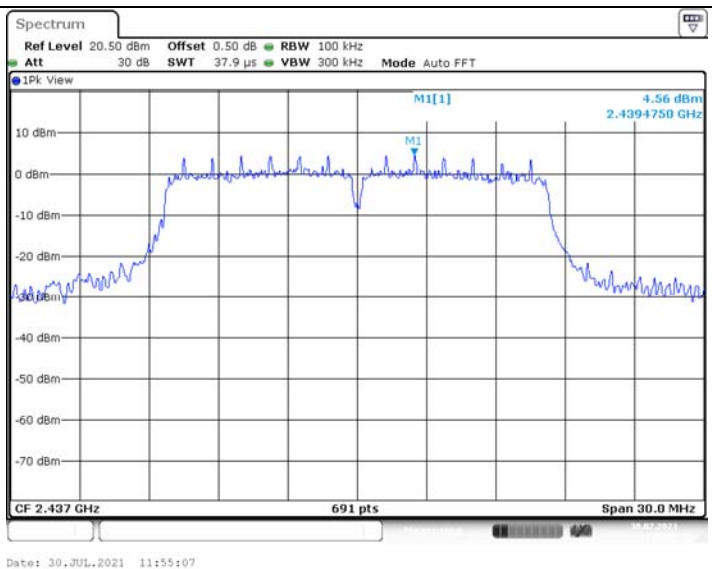

802.11g 2437 30~1000

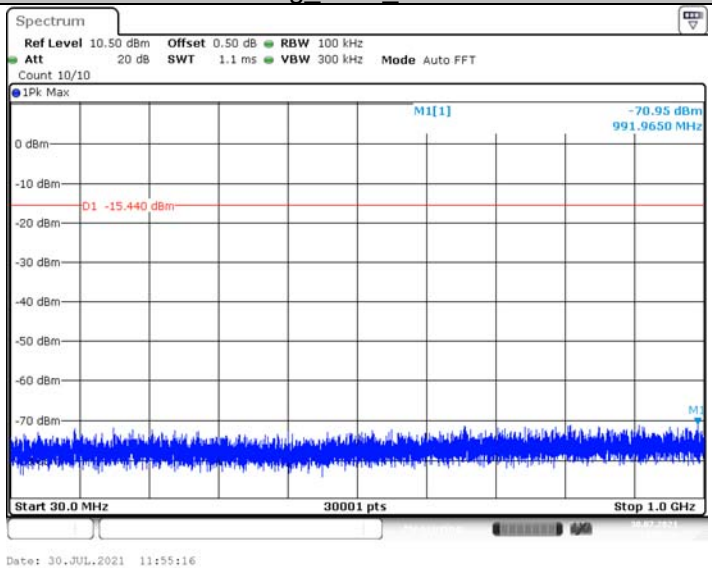

802.11g 2437 1000~26500

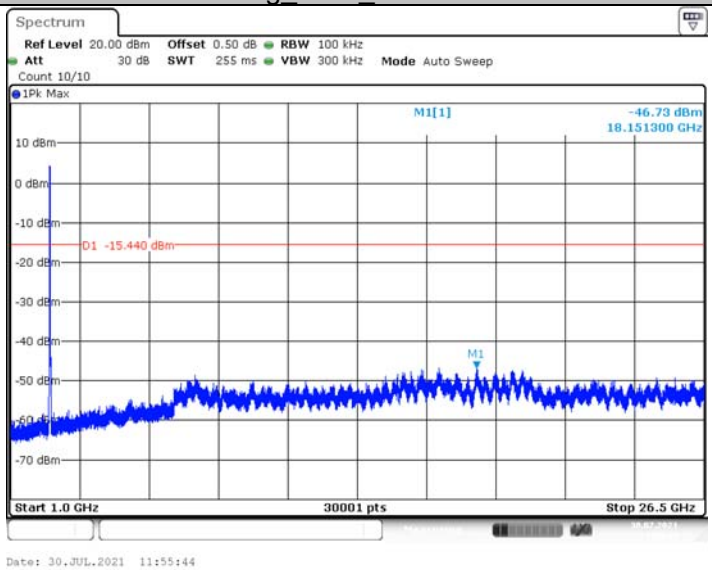

802.11g 2462 0~Reference

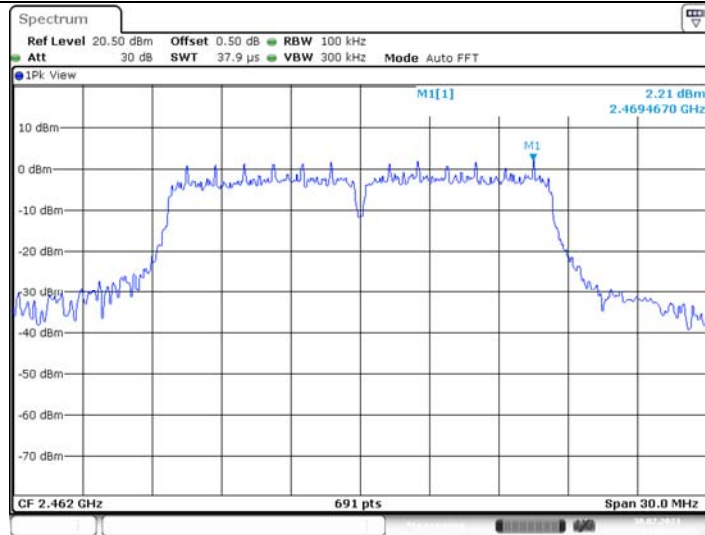

Date: 30.JUL.2021 11:58:20

802.11g 2462 30~1000

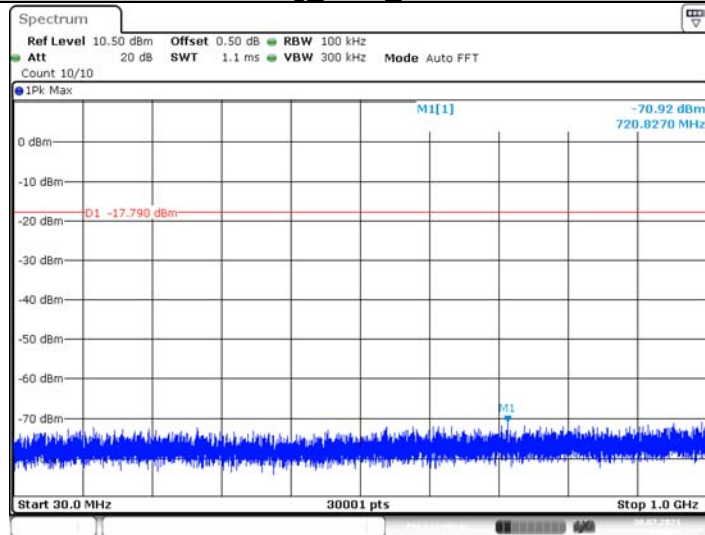

Date: 30.JUL.2021 11:58:29

802.11g 2462 1000~26500

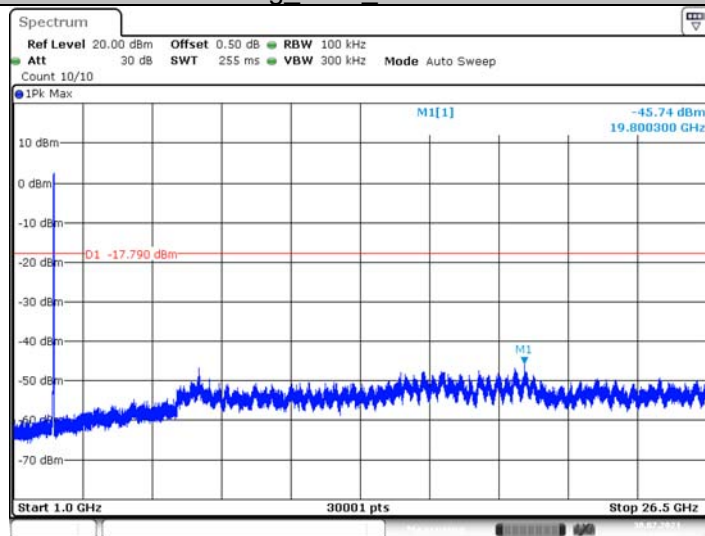

Date: 30.JUL.2021 11:58:57

802.11n(HT20) 2412_0~Reference

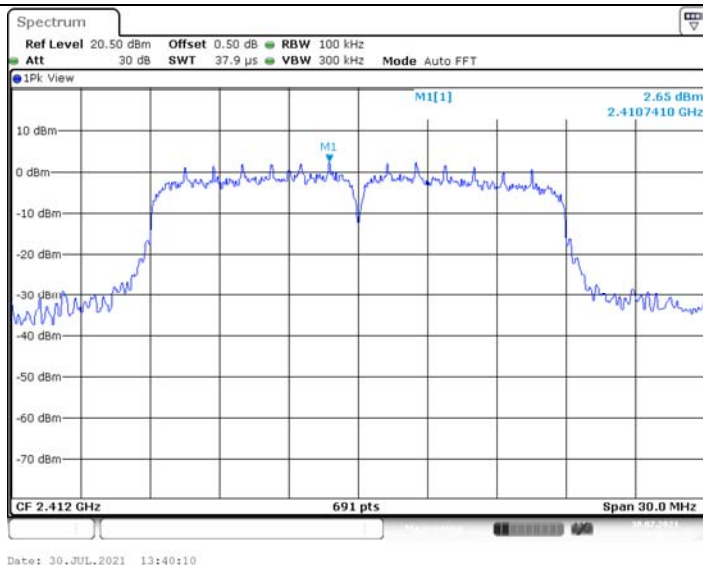

802.11n(HT20) 2412_30~1000

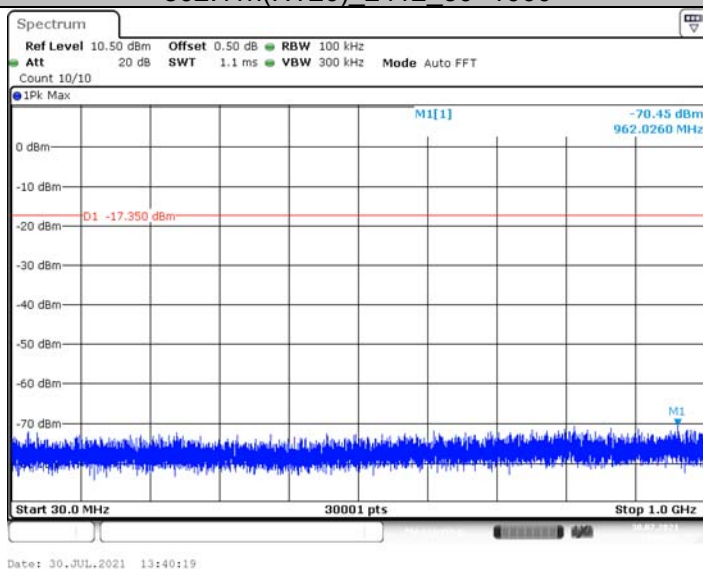

802.11n(HT20) 2412_1000~26500

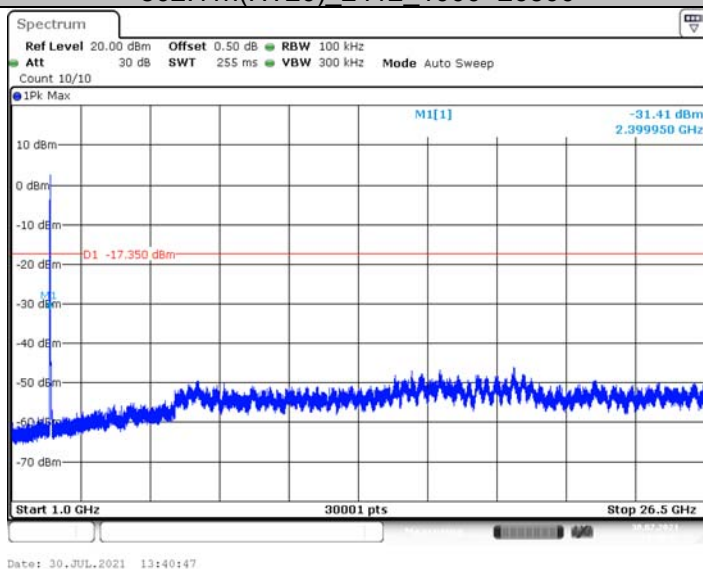

802.11n(HT20) 2437_0~Reference

CTC Laboratories, Inc.

1-2/F., Building 2, Jiaquan Building, Guanlan High-Tech Park, Shenzhen, Guangdong, China
Tel.: (86)755-27521059 Fax: (86)755-27521011 Http://www.sz-ctc.org.cn



For anti-fake verification, please visit the official website of Certification and Accreditation Administration of the People's Republic of China: yz.cnca.cn

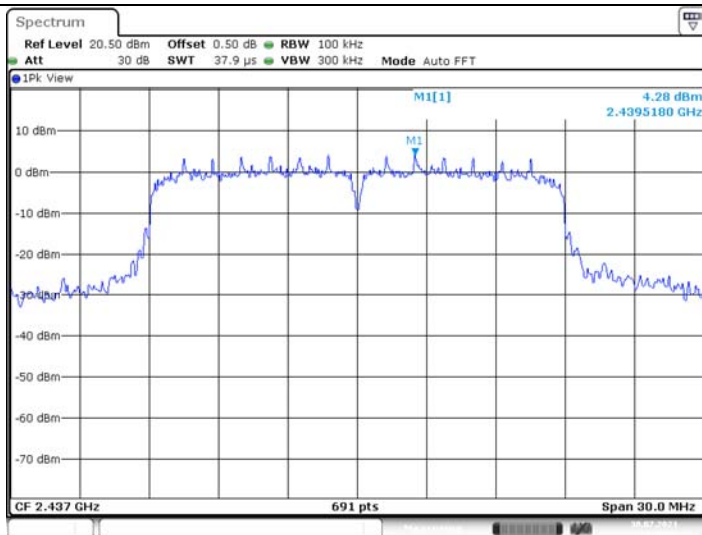

802.11n(HT20) 2437_30~1000

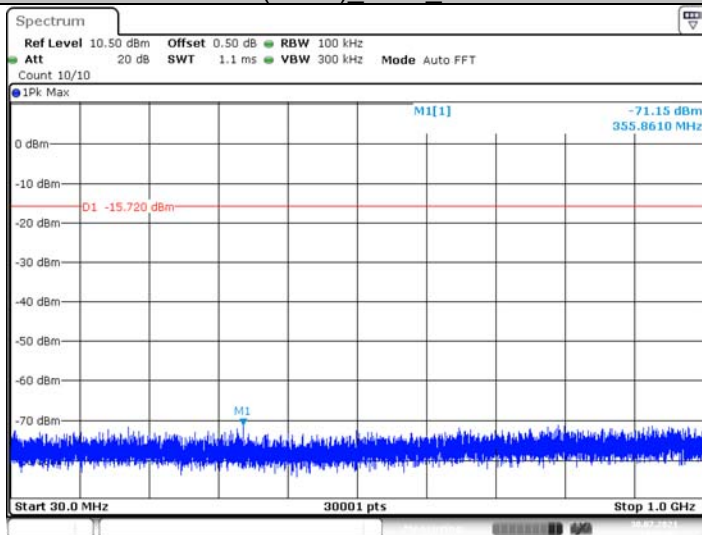

802.11n(HT20) 2437_1000~26500

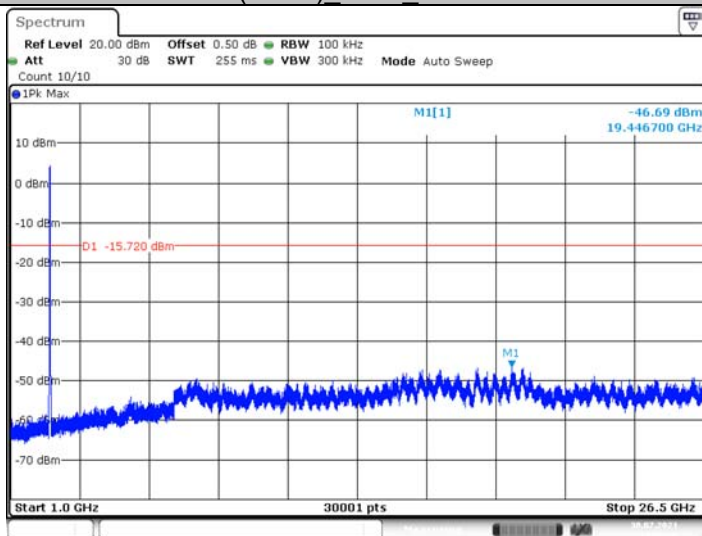

802.11n(HT20) 2462_0~Reference

CTC Laboratories, Inc.

1-2/F., Building 2, Jiaquan Building, Guanlan High-Tech Park, Shenzhen, Guangdong, China

Tel.: (86)755-27521059

Fax: (86)755-27521011

Http://www.sz-ctc.org.cn



For anti-fake verification, please visit the official website of Certification and Accreditation Administration of the People's Republic of China : yz.cnca.cn

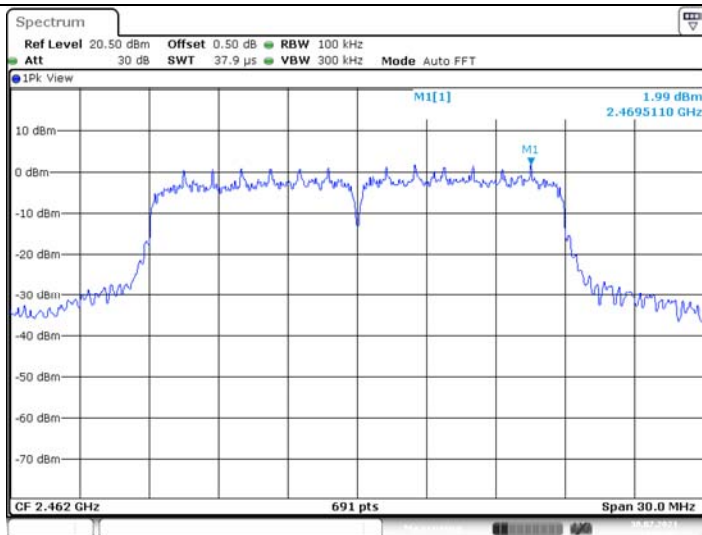

802.11n(HT20) 2462 30~1000

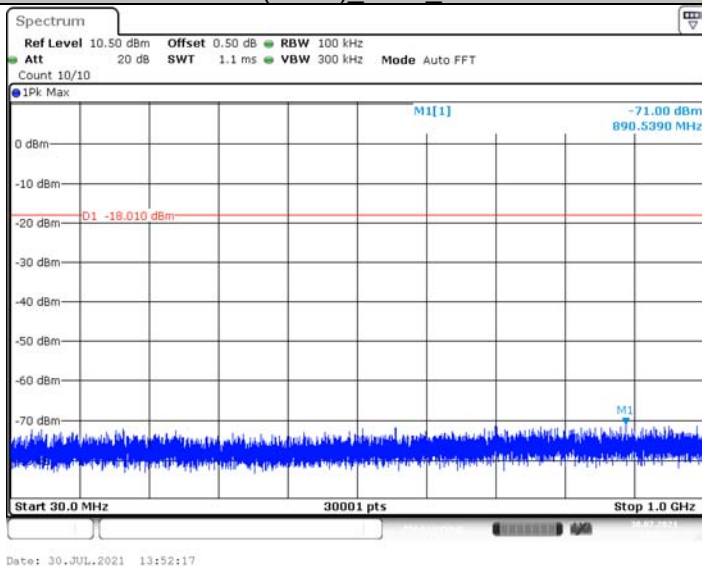

802.11n(HT20) 2462 1000~26500

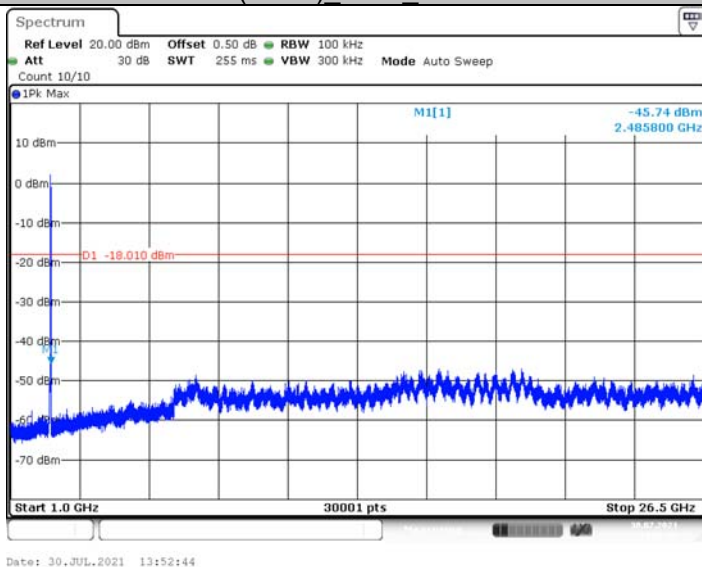

802.11n(HT40) 2422 0~Reference

CTC Laboratories, Inc.

1-2/F., Building 2, Jiaquan Building, Guanlan High-Tech Park, Shenzhen, Guangdong, China

Tel.: (86)755-27521059

Fax: (86)755-27521011

Http://www.sz-ctc.org.cn



For anti-fake verification, please visit the official website of Certification and Accreditation Administration of the People's Republic of China : yz.cnca.cn

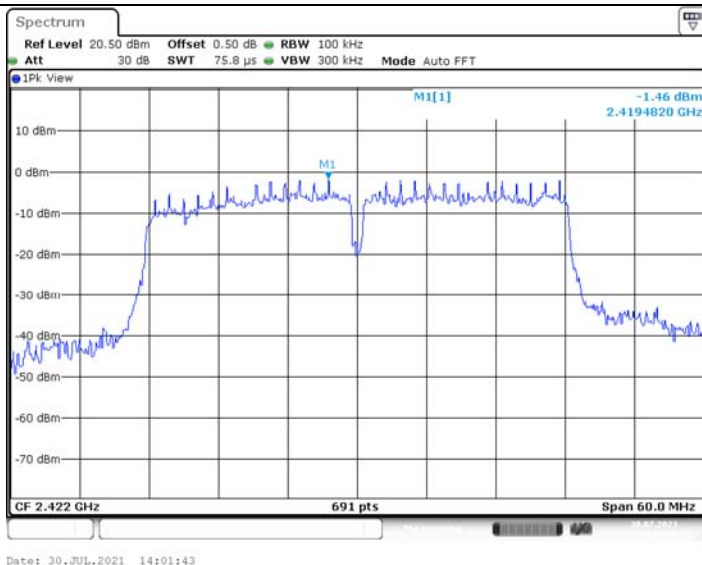

802.11n(HT40) 2422 30~1000

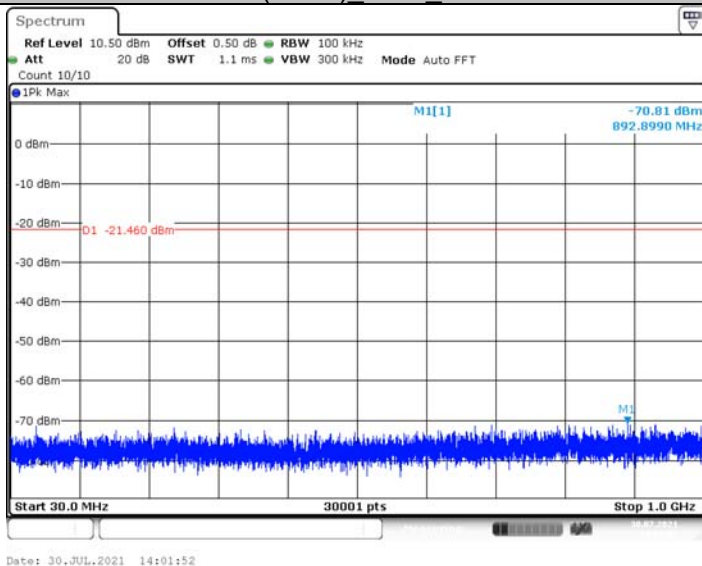

802.11n(HT40) 2422 1000~26500

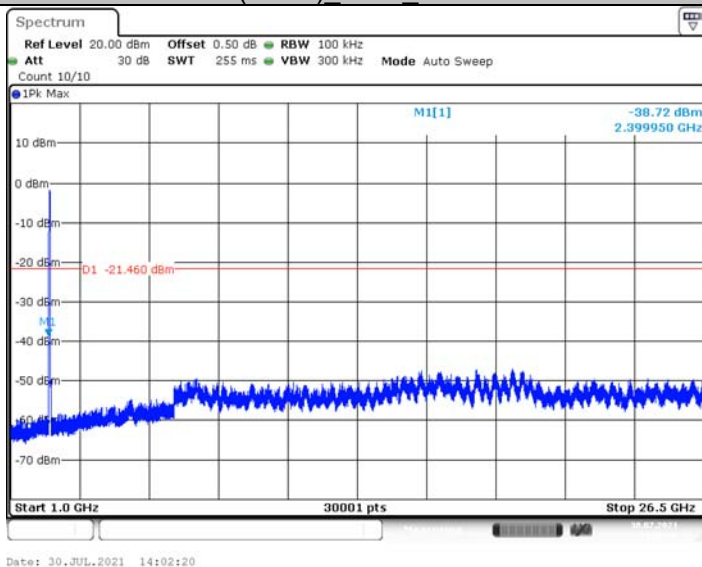

802.11n(HT40) 2437 0~Reference

CTC Laboratories, Inc.

1-2/F., Building 2, Jiaquan Building, Guanlan High-Tech Park, Shenzhen, Guangdong, China
Tel.: (86)755-27521059 Fax: (86)755-27521011 Http://www.sz-ctc.org.cn



For anti-fake verification, please visit the official website of Certification and Accreditation Administration of the People's Republic of China: yz.cnca.cn

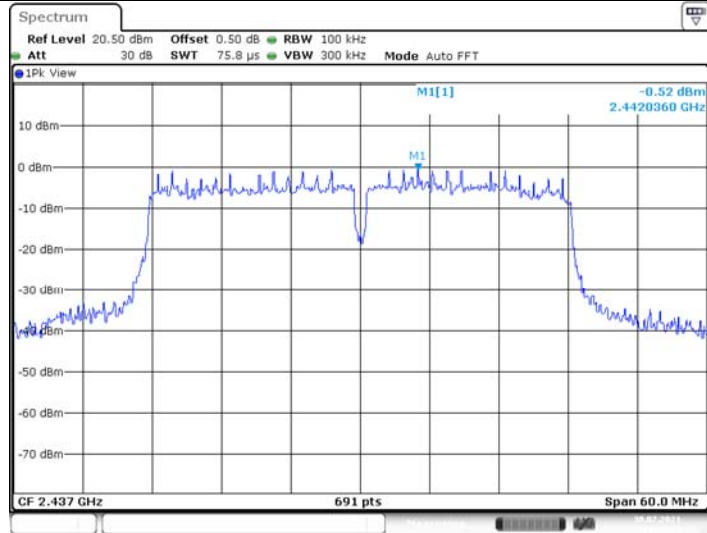

802.11n(HT40) 2437_30~1000

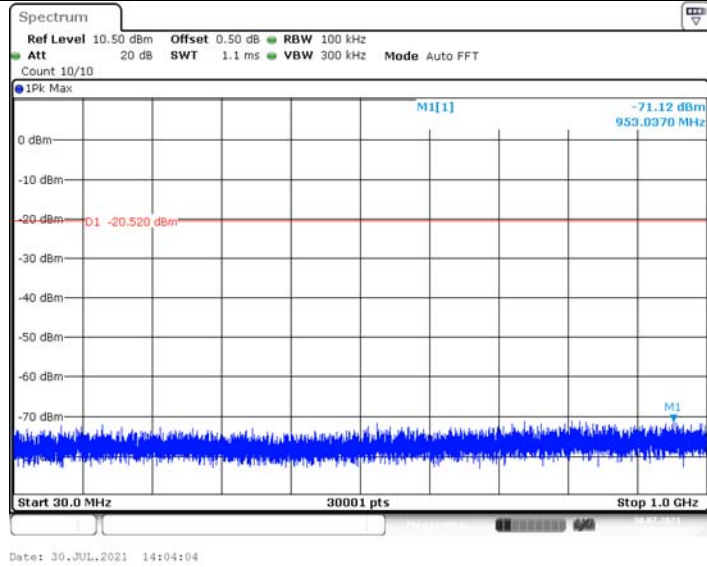

802.11n(HT40) 2437_1000~26500

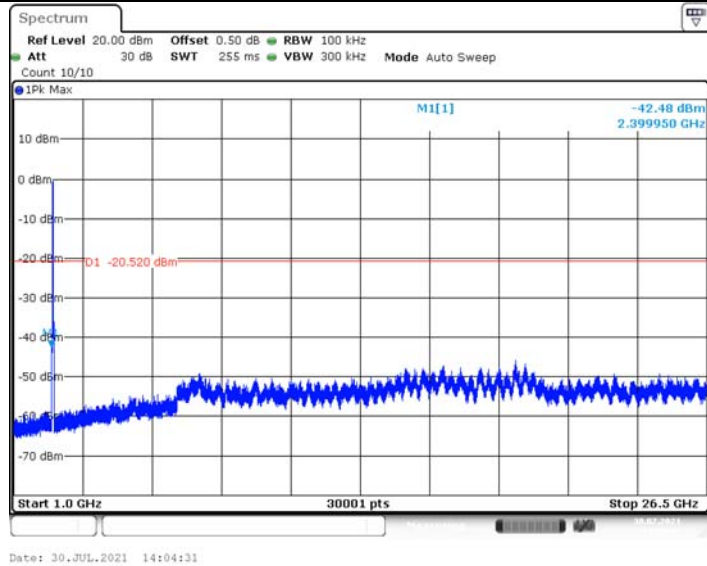

802.11n(HT40) 2452_0~Reference

CTC Laboratories, Inc.

1-2/F., Building 2, Jiaquan Building, Guanlan High-Tech Park, Shenzhen, Guangdong, China
Tel.: (86)755-27521059 Fax: (86)755-27521011 Http://www.sz-ctc.org.cn



For anti-fake verification, please visit the official website of Certification and Accreditation Administration of the People's Republic of China: yz.cnca.cn

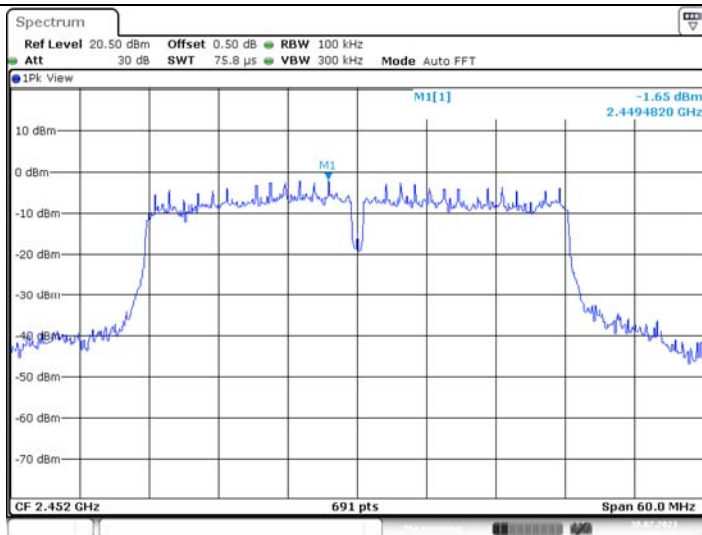

802.11n(HT40) 2452 30~1000

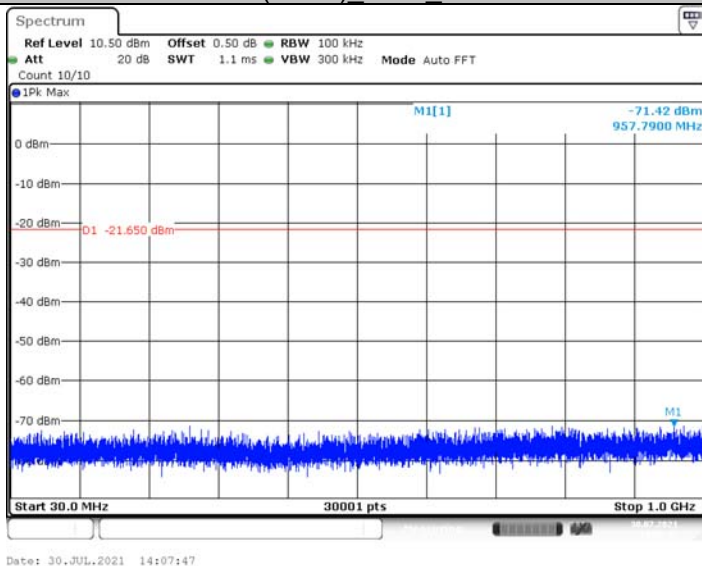

802.11n(HT40) 2452 1000~26500

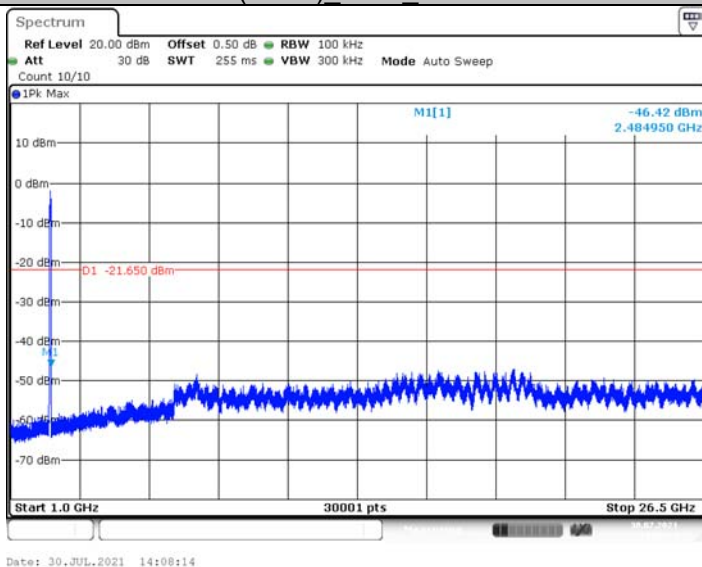



3.5. DTS Bandwidth

Limit

FCC CFR Title 47 Part 15 Subpart C Section 15.247 (a)(2)/ RSS-247 5.2 a:

Test Item	Limit	Frequency Range(MHz)
DTS Bandwidth	≥ 500 KHz (6dB bandwidth)	2400~2483.5

Test Configuration

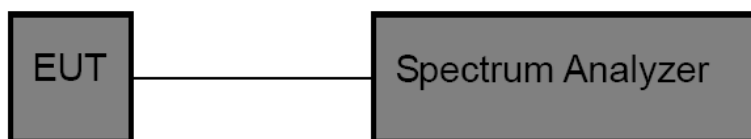

Test Procedure

5. The EUT was directly connected to the spectrum analyzer and antenna output port as show in the block diagram above.
6. DTS Spectrum Setting:
 - (1) Set RBW = 100 kHz.
 - (2) Set the video bandwidth (VBW) ≥ 3 RBW.
 - (3) Detector = Peak.
 - (4) Trace mode = Max hold.
 - (5) Sweep = Auto couple.
- OCB Spectrum Setting:
 - (1) Set RBW = 1% ~ 5% occupied bandwidth.
 - (2) Set the video bandwidth (VBW) ≥ 3 RBW.
 - (3) Detector = Peak.
 - (4) Trace mode = Max hold.
 - (5) Sweep = Auto couple.

NOTE: The EUT was set to continuously transmitting in each mode and low, Middle and high channel for the test.

Test Mode

Please refer to the clause 2.4.



Test Results

Test Mode	Channel	DTS BW [MHz]	Limit[MHz]	Verdict
802.11b	2412	8.640	>=0.5	PASS
	2437	9.120	>=0.5	PASS
	2462	9.120	>=0.5	PASS
802.11g	2412	16.360	>=0.5	PASS
	2437	16.360	>=0.5	PASS
	2462	16.400	>=0.5	PASS
802.11n(HT20)	2412	15.720	>=0.5	PASS
	2437	17.160	>=0.5	PASS
	2462	17.080	>=0.5	PASS
802.11n(HT40)	2422	35.920	>=0.5	PASS
	2437	35.760	>=0.5	PASS
	2452	35.360	>=0.5	PASS



802.11b_2412

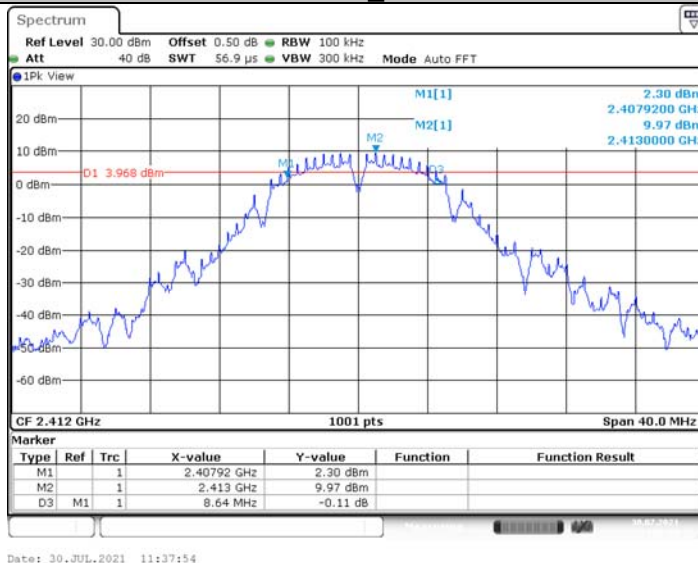

802.11b_2437

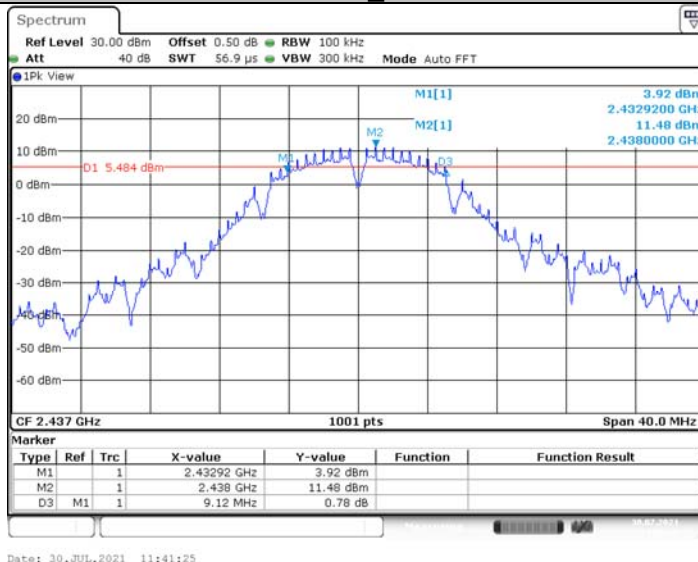

802.11b_2462

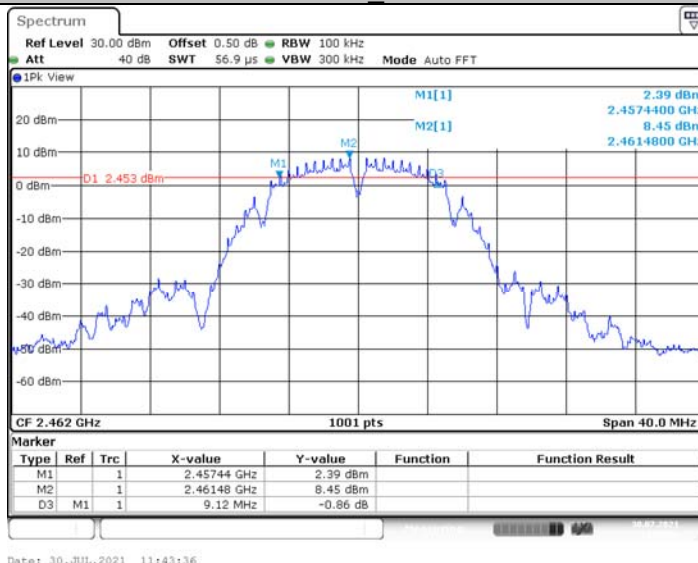

802.11g_2412

CTC Laboratories, Inc.

1-2/F., Building 2, Jiaquan Building, Guanlan High-Tech Park, Shenzhen, Guangdong, China

Tel.: (86)755-27521059

Fax: (86)755-27521011

Http://www.sz-ctc.org.cn



For anti-fake verification, please visit the official website of Certification and Accreditation Administration of the People's Republic of China : yz.cnca.cn

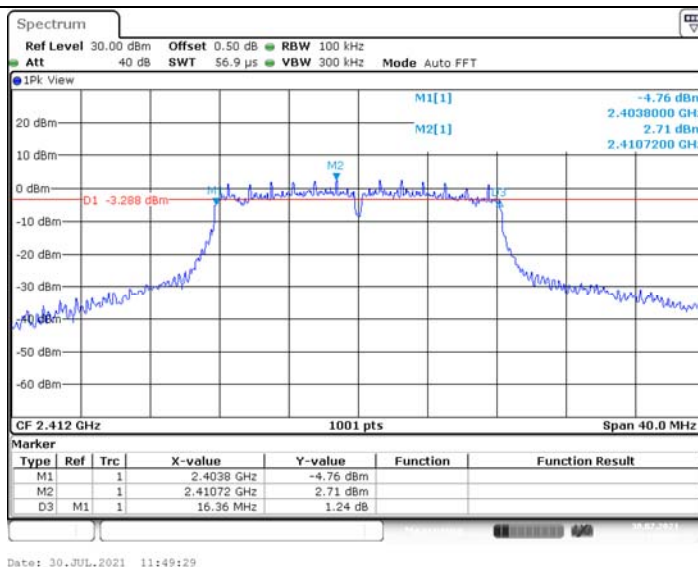

802.11g_2437

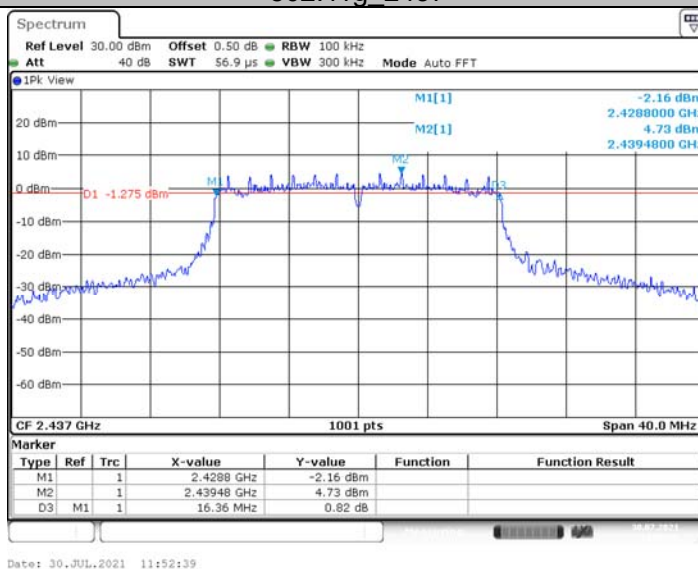

802.11g_2462

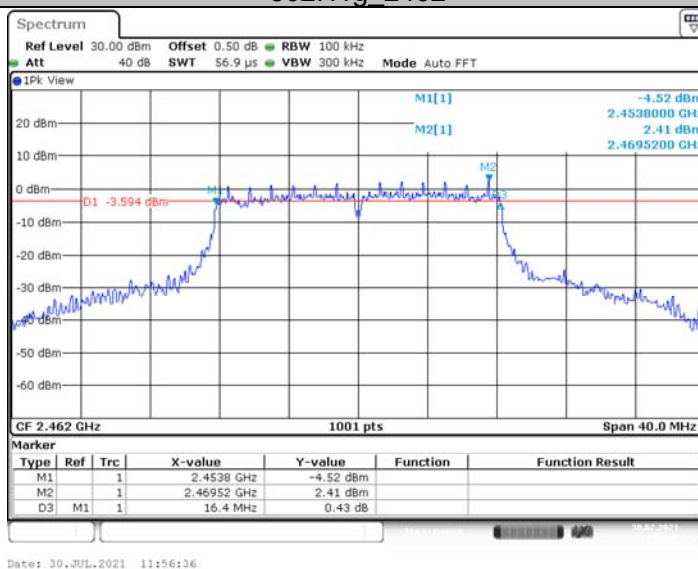

802.11n(HT20)_2412

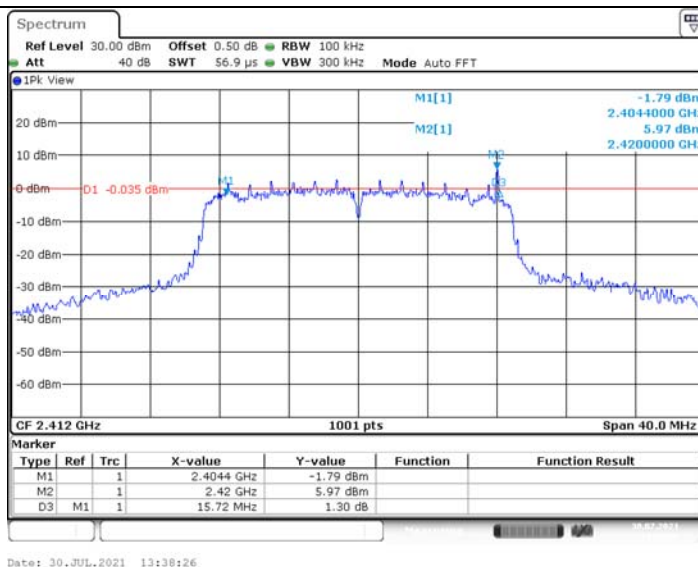

802.11n(HT20)_2437

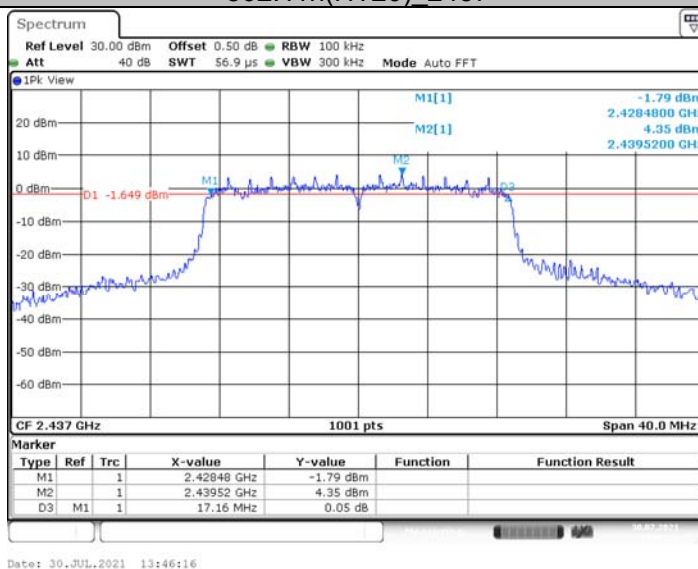

802.11n(HT20)_2462

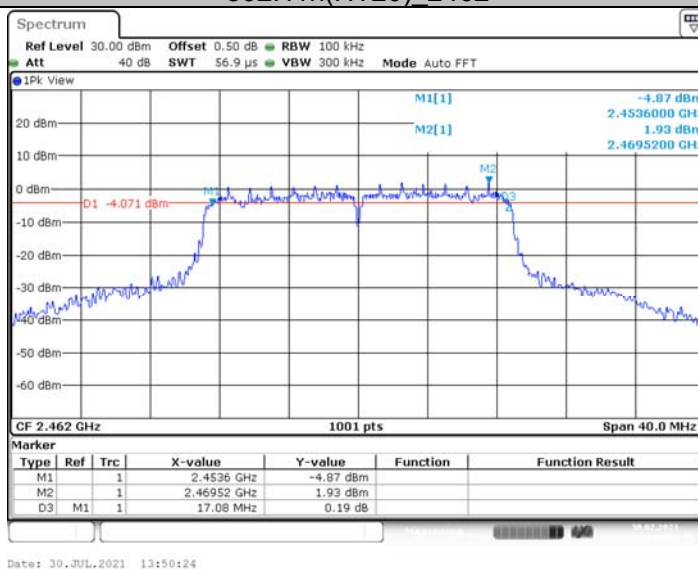

802.11n(HT40)_2422

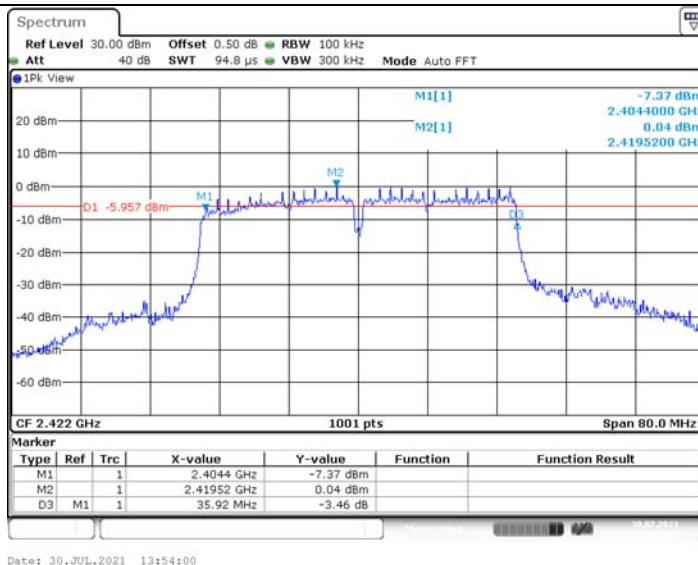

802.11n(HT40)_2437

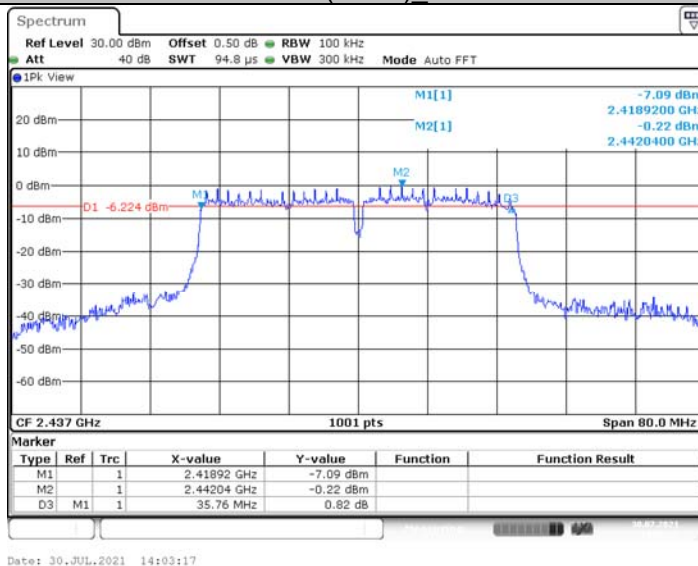

802.11n(HT40)_2452

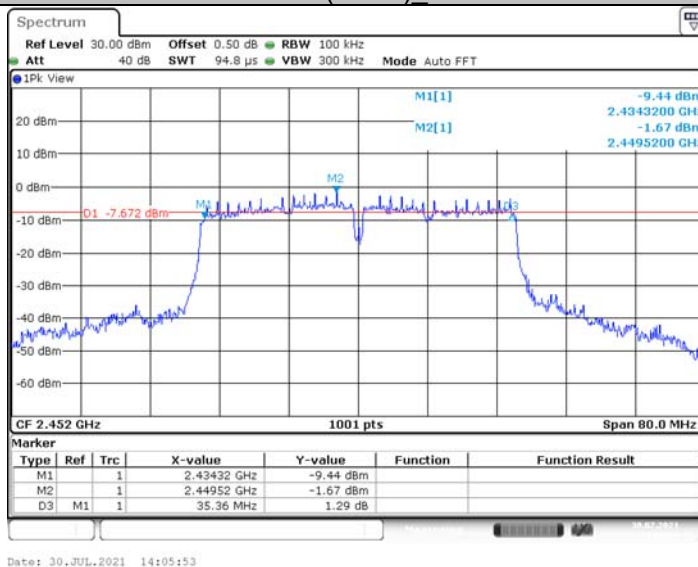



3.6. Peak Output Power

Limit

FCC CFR Title 47 Part 15 Subpart C Section 15.247 (b)(3)/ RSS-247 5.4:

Section	Test Item	Limit	Frequency Range(MHz)
CFR 47 FCC 15.247(b)(3)	Maximum conducted output power	1 Watt or 30dBm	2400~2483.5
ISED RSS-247 5.4 d	EIRP	4 Watt or 36dBm	2400~2483.5

Test Configuration

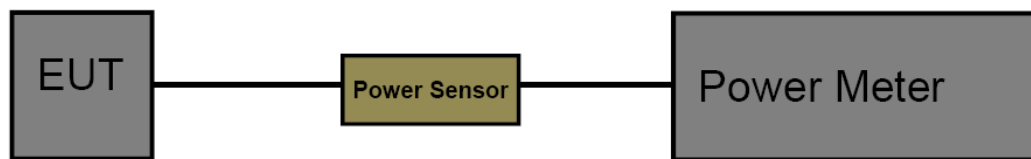

Test Procedure

1. The maximum conducted output power may be measured using a broadband Peak RF power meter.
2. Peak power measurements were performed only when the EUT was transmitting at its maximum power control level using a broadband power meter with a pulse sensor.
3. The power meter implemented triggering and gating capabilities which were set up such that power measurements were recorded only during the ON time of the transmitter.
4. Record the measurement data.

Test Mode

Please refer to the clause 2.4.

Test Result



Test Mode	Channel	Result[dBm]	Limit[dBm]	Verdict
802.11b	2412	20.85	<=30	PASS
	2437	22.53	<=30	PASS
	2462	20.19	<=30	PASS
802.11g	2412	20.49	<=30	PASS
	2437	22.59	<=30	PASS
	2462	20.16	<=30	PASS
802.11n(HT20)	2412	20.19	<=30	PASS
	2437	22.38	<=30	PASS
	2462	19.99	<=30	PASS
802.11n(HT40)	2422	18.85	<=30	PASS
	2437	20.37	<=30	PASS
	2452	18.20	<=30	PASS

Note: Test results increased RF cable loss by 0.5dB.



3.7. Power Spectral Density

Limit

FCC CFR Title 47 Part 15 Subpart C Section 15.247 (e)/ RSS-247 5.2 b:

Test Item	Limit	Frequency Range(MHz)
Power Spectral Density	8dBm(in any 3 kHz)	2400~2483.5

Test Configuration

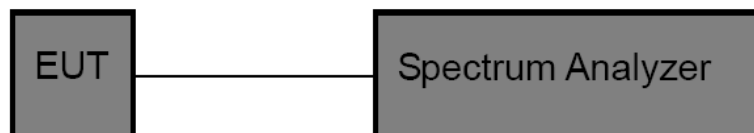

Test Procedure

1. The EUT was directly connected to the spectrum analyzer and antenna output port as show in the block diagram above.
2. The EUT was directly connected to the Spectrum Analyzer and antenna output port as show in the block diagram above. The measurement according to section 10.2 of KDB 558074 D01 DTS Meas Guidance v05r02.
3. Spectrum Setting:
Set analyzer center frequency to DTS channel center frequency.
Set the span to 1.5 times the DTS bandwidth.
Set the RBW to: 3 kHz
Set the VBW to: 10 kHz
Detector: PK
Sweep time: Auto
Allow trace to fully stabilize. Then use the peak marker function to determine the maximum amplitude level.

Test Mode

Please refer to the clause 2.4.

**Test Result**

Test Mode	Channel	Result[dBm/3kHz]	Limit[dBm/3kHz]	Verdict
802.11b	2412	-4.59	<=8	PASS
	2437	-3.44	<=8	PASS
	2462	-5.44	<=8	PASS
802.11g	2412	-11.75	<=8	PASS
	2437	-10.34	<=8	PASS
	2462	-12.52	<=8	PASS
802.11n(HT20)	2412	-11.44	<=8	PASS
	2437	-9.85	<=8	PASS
	2462	-13.81	<=8	PASS
802.11n(HT40)	2422	-16.03	<=8	PASS
	2437	-14.15	<=8	PASS
	2452	-16.36	<=8	PASS



802.11b_2412

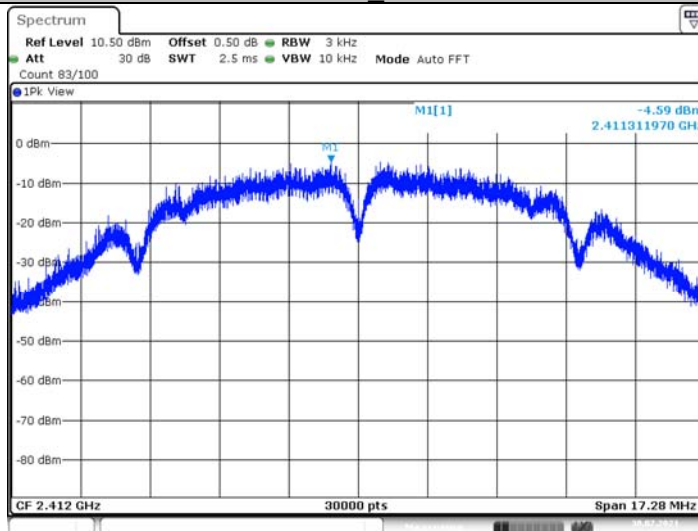

Date: 30.JUL.2021 11:38:24

802.11b_2437

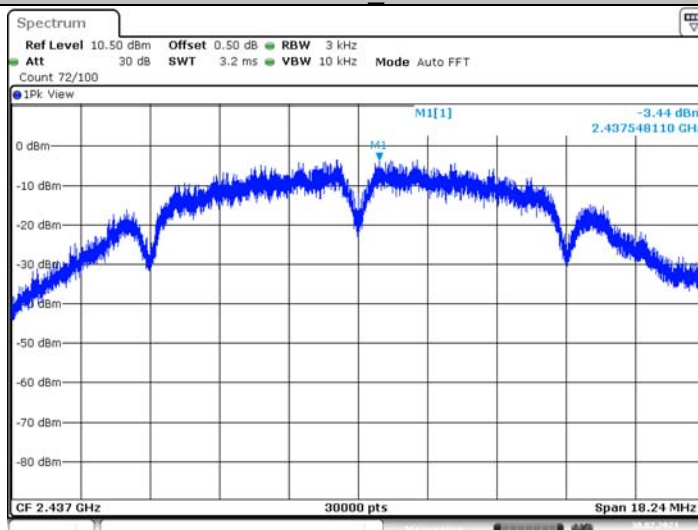

Date: 30.JUL.2021 11:41:54

802.11b_2462

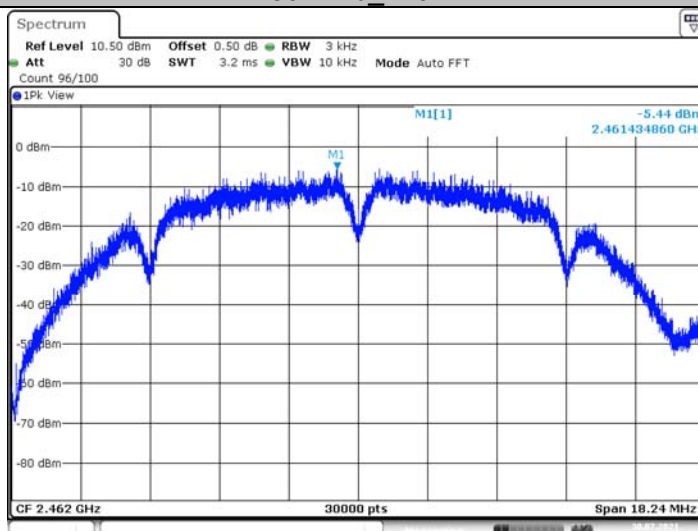

Date: 30.JUL.2021 11:44:05

802.11g_2412

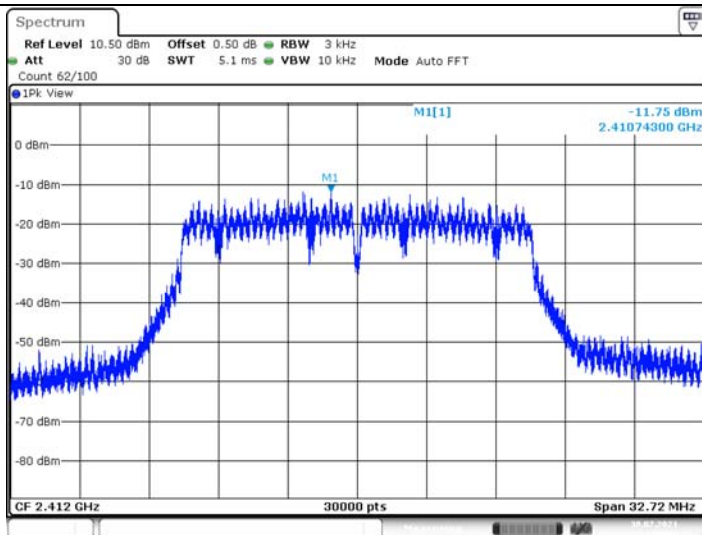

802.11g_2437

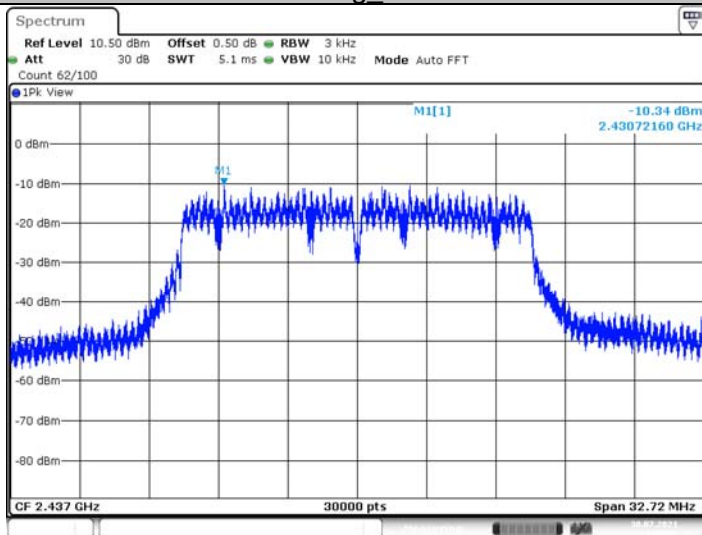

802.11g_2462

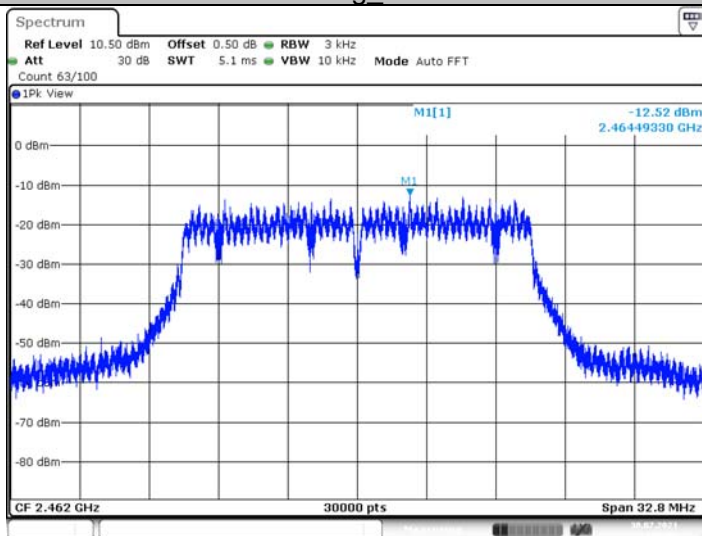

802.11n(HT20)_2412

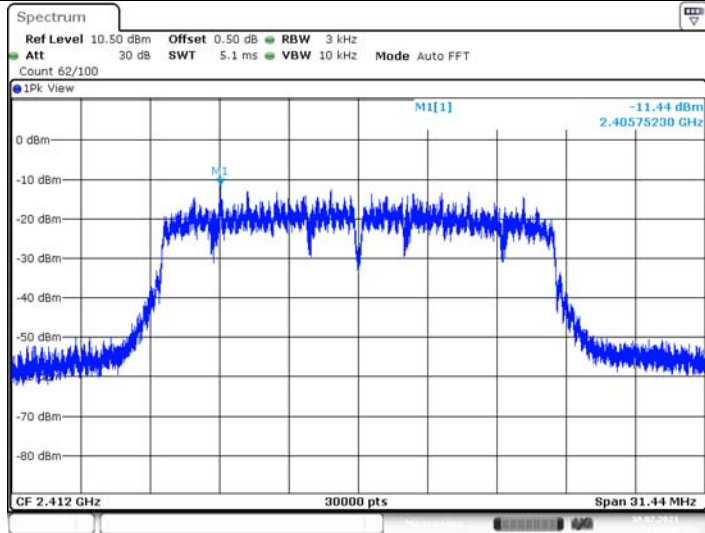

802.11n(HT20)_2437

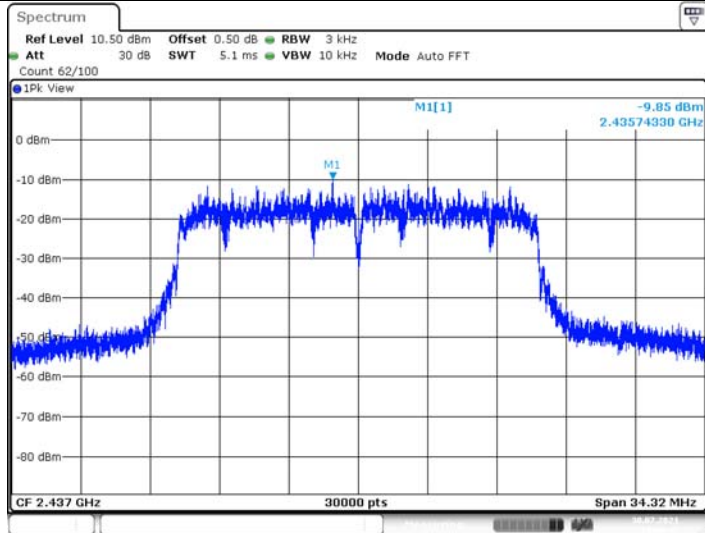

802.11n(HT20)_2462

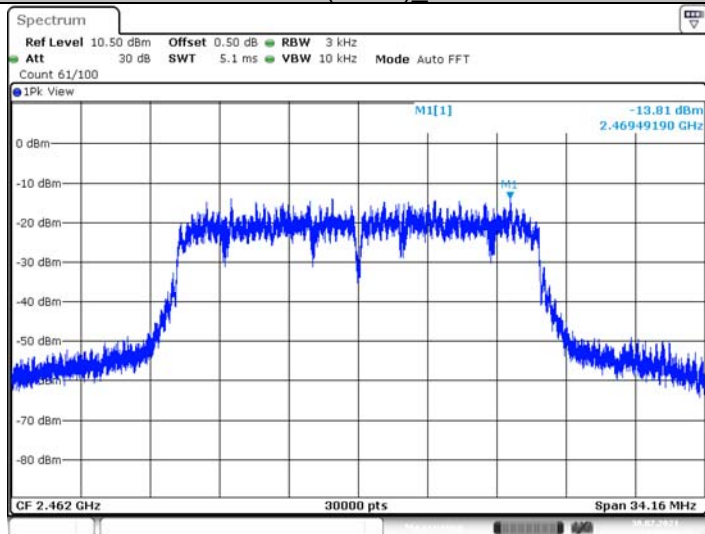

802.11n(HT40)_2422

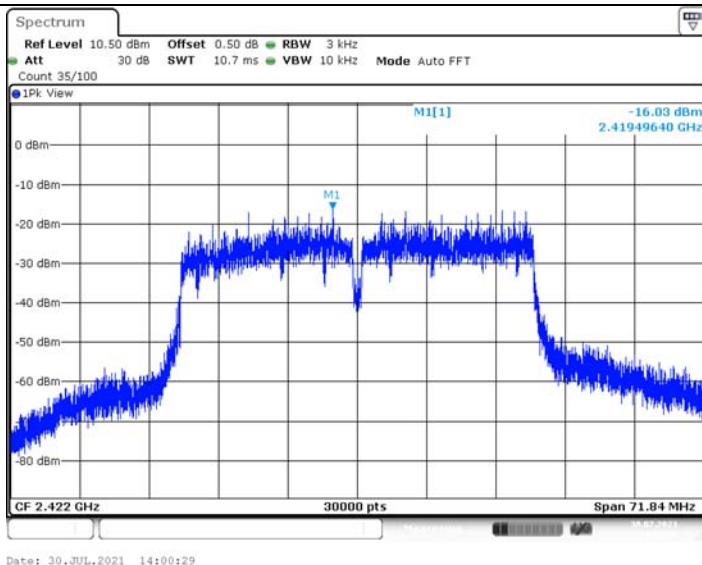

802.11n(HT40) 2437

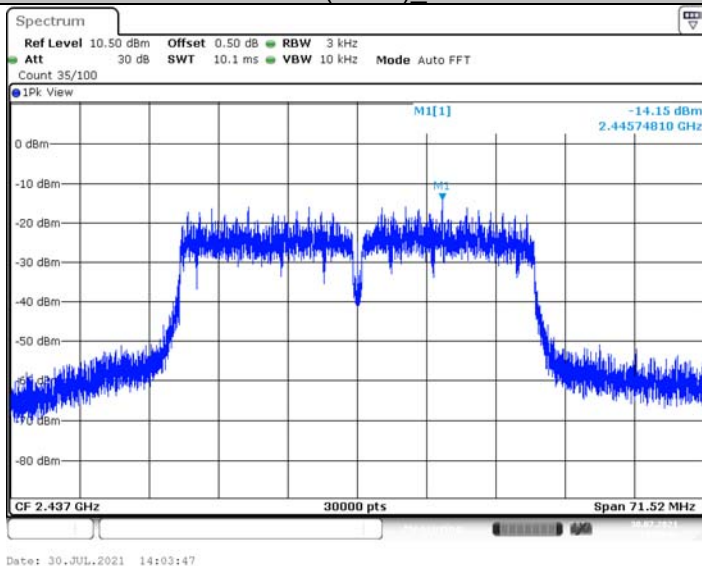

802.11n(HT40) 2452

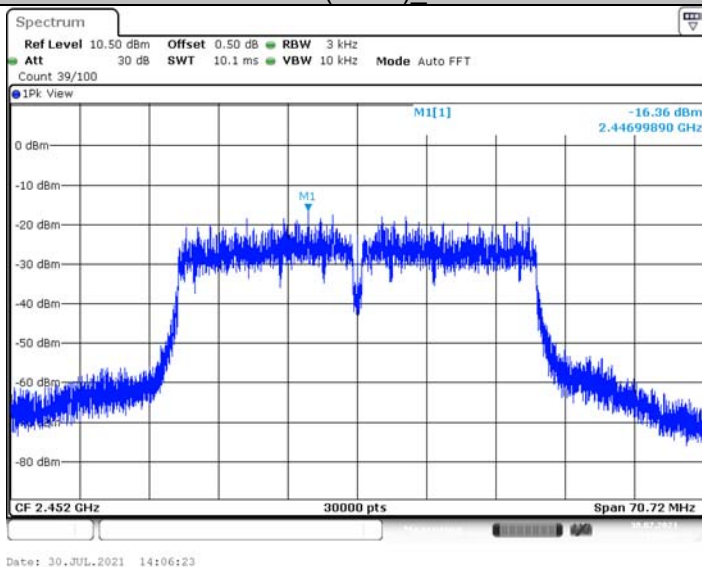



3.8. Duty Cycle

Limit

None, for report purposes only.

Test Configuration

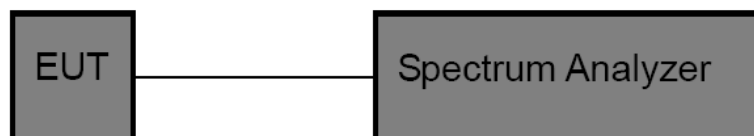

Test Procedure

1. The EUT was directly connected to the spectrum analyzer and antenna output port as show in the block diagram above.
2. The EUT was directly connected to the Spectrum Analyzer and antenna output port as show in the block diagram above. The measurement according to section 10.2 of KDB 558074 D01 DTS Meas Guidance v05r02.
3. Spectrum Setting:
Set analyzer center frequency to DTS channel center frequency.
Set the span to 0Hz
Set the RBW to 10MHz
Set the VBW to 10MHz
Detector: peak
Sweep time: auto
Allow trace to fully stabilize. Then use the peak marker function to determine the maximum amplitude level.

Test Mode

Please refer to the clause 2.4.

Test Result



Test Mode	Channel	Transmission Duration [ms]	Transmission Period [ms]	Duty Cycle [%]	1/T Minimum VBW (kHz)	Final setting For VBW (kHz)
802.11b	2412	0.728	0.810	89.81	1.23	2
	2437	0.730	0.810	90.12	1.23	2
	2462	0.730	0.810	90.12	1.23	2
802.11g	2412	0.113	0.188	60.00	5.32	6.2
	2437	0.114	0.188	60.67	5.32	6.2
	2462	0.114	0.188	60.67	5.32	6.2
802.11n(HT20)	2412	0.112	0.186	60.40	5.38	6.2
	2437	0.113	0.186	60.40	5.38	6.2
	2462	0.111	0.186	59.73	5.38	6.2
802.11n(HT40)	2422	0.073	0.146	49.57	6.85	8.2
	2437	0.074	0.146	50.43	6.85	8.2
	2452	0.073	0.146	49.57	6.85	8.2



802.11b_2412

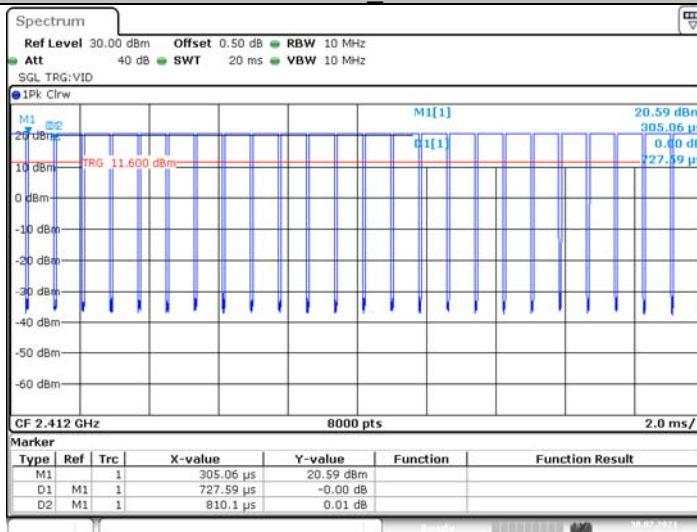

Date: 30.JUL.2021 11:37:32

802.11b_2437

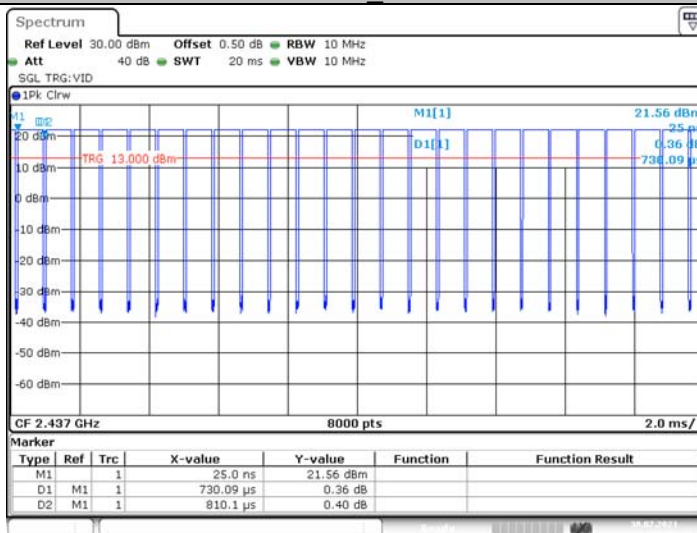

Date: 30.JUL.2021 11:41:02

802.11b_2462

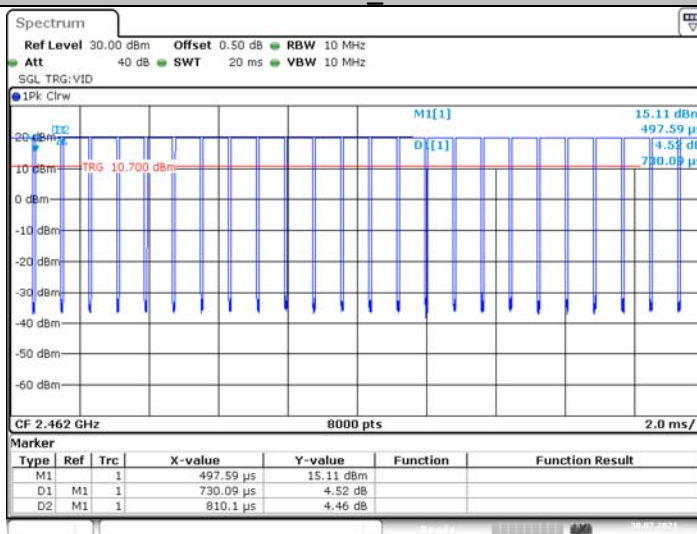

Date: 30.JUL.2021 11:43:13

802.11g_2412

CTC Laboratories, Inc.

1-2/F., Building 2, Jiaquan Building, Guanlan High-Tech Park, Shenzhen, Guangdong, China

Tel.: (86)755-27521059

Fax: (86)755-27521011

Http://www.sz-ctc.org.cn



For anti-fake verification, please visit the official website of Certification and Accreditation Administration of the People's Republic of China : yz.cnca.cn

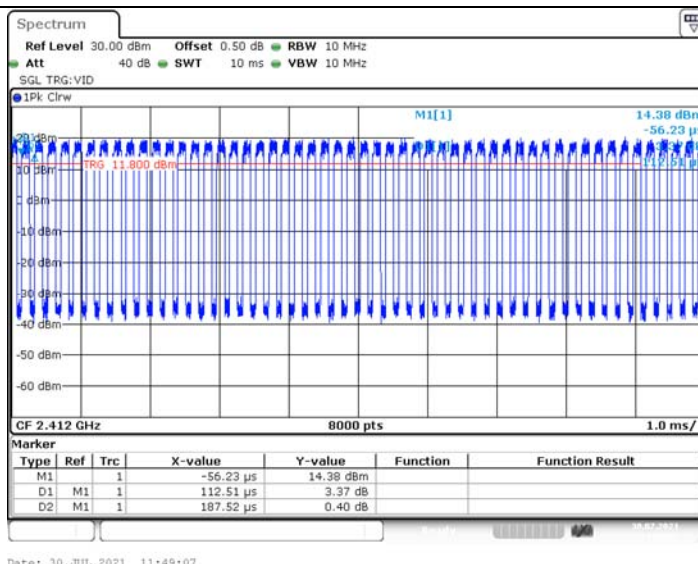

802.11g_2437

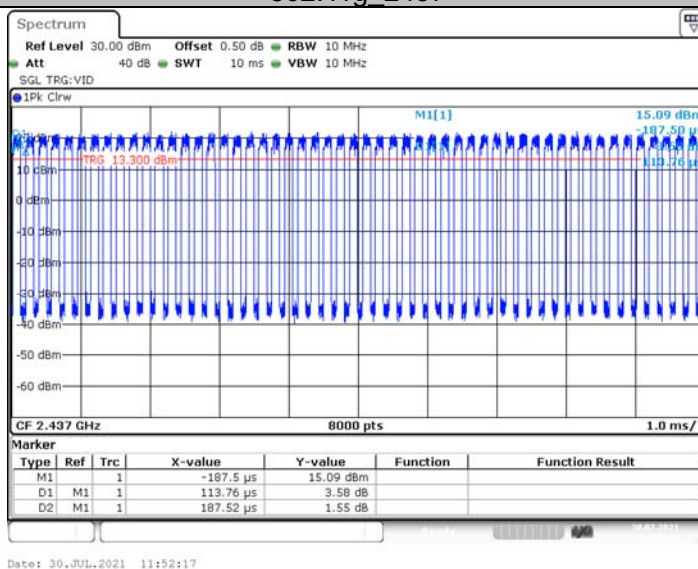

802.11g_2462

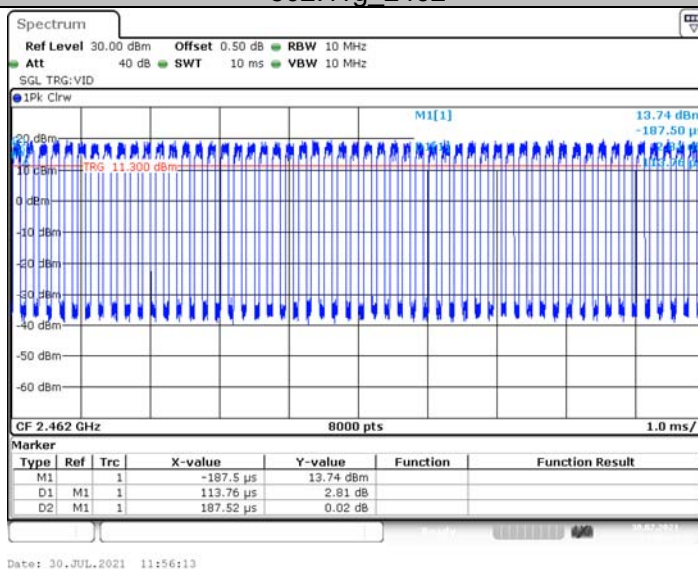

802.11n(HT20)_2412

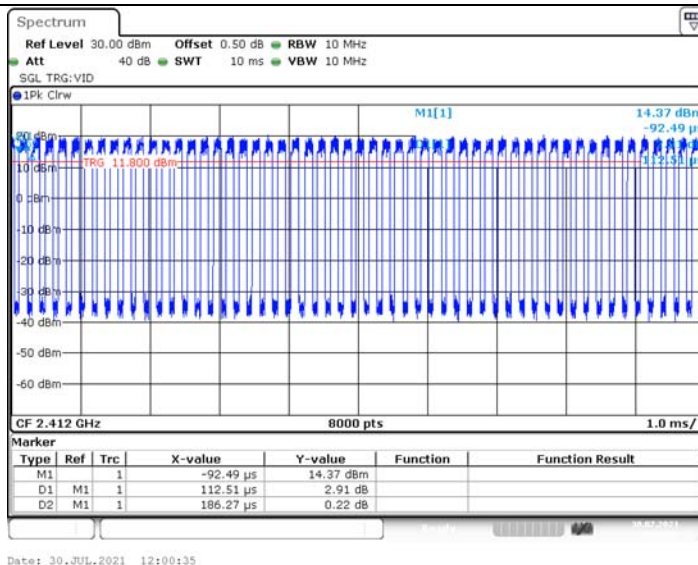

802.11n(HT20)_2437

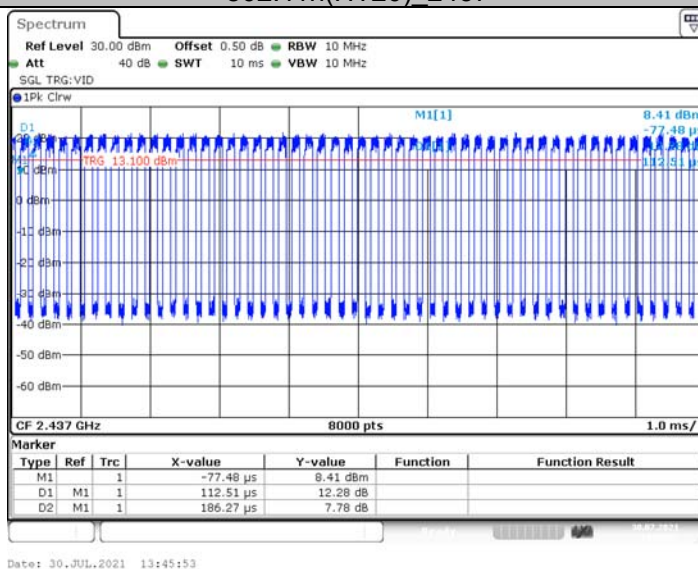

802.11n(HT20)_2462

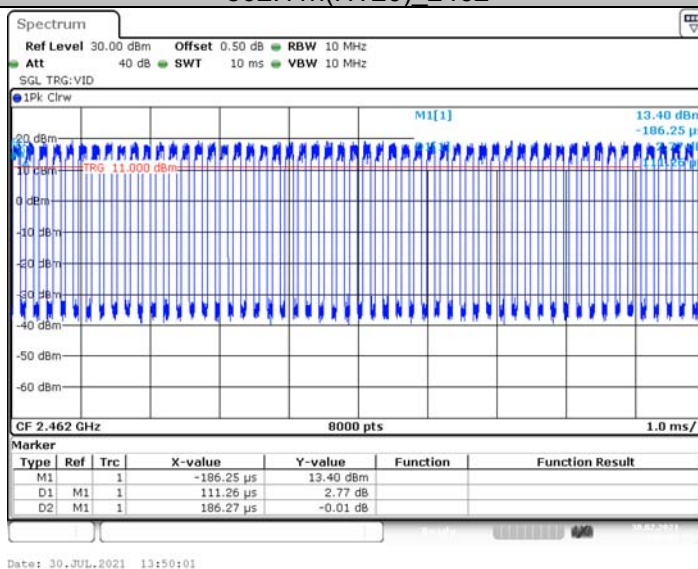

802.11n(HT40)_2422



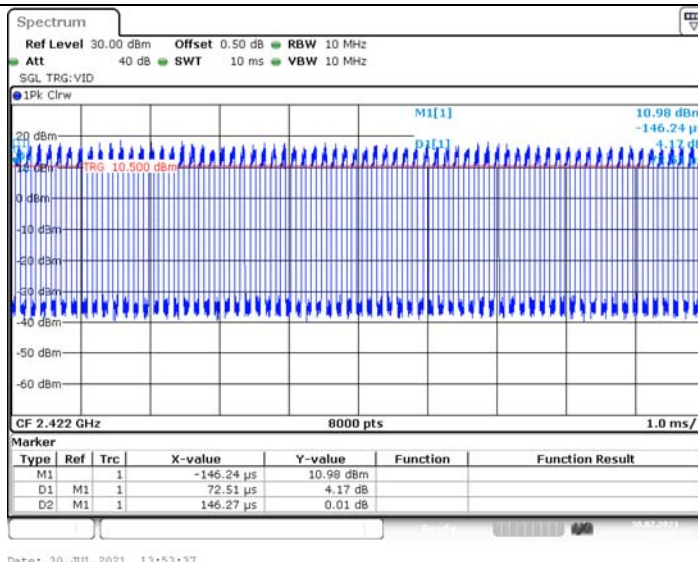

802.11n(HT40)_2437

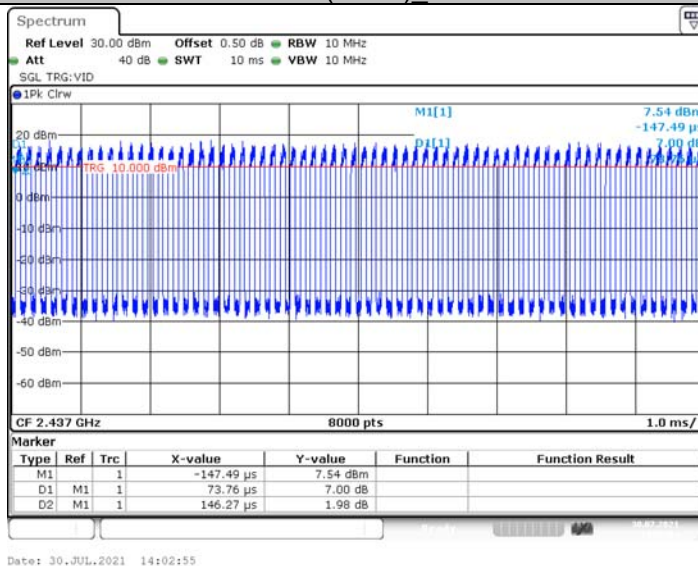

802.11n(HT40)_2452

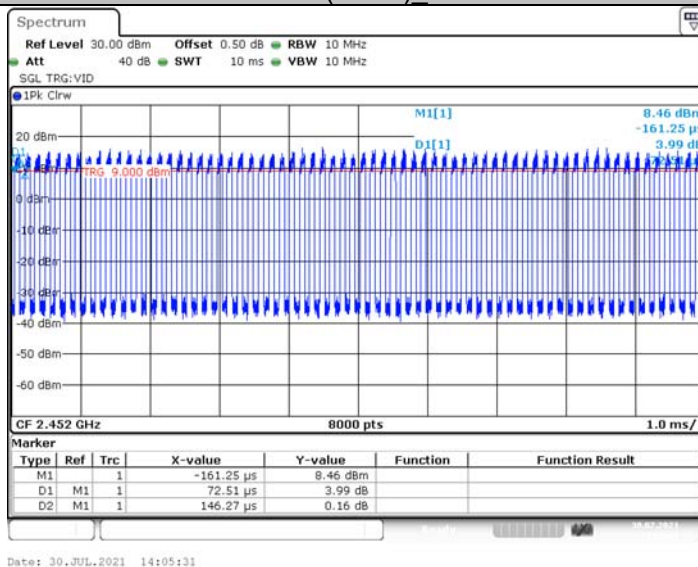



3.9. Antenna requirement

Requirement

FCC CFR Title 47 Part 15 Subpart C Section 15.203:

An intentional radiator shall be designed to ensure that no antenna other than that furnished by the responsible party shall be used with the device. The use of a permanently attached antenna or of antenna that uses a unique coupling to the intentional radiator, the manufacturer may design the unit so that a broken antenna can be replaced by the user, but the use of a standard antenna jack or electrical connector is prohibited.

FCC CFR Title 47 Part 15 Subpart C Section 15.247(c) (1)(i):

(i) Systems operating in the 2400~2483.5 MHz band that is used exclusively for fixed. Point-to-point operations may employ transmitting antennas with directional gain greater than 6dBi provided the maximum conducted output power of the intentional radiator is reduced by 1 dB for every 3 dB that the directional gain of the antenna exceeds 6dBi.

Test Result

The directional gain of the antenna less than 6dBi, please refer to the EUT internal photographs antenna photo.

*****THE END*****