



Shenzhen CTA Testing Technology Co., Ltd.

Room 106, Building 1, Yibaolai Industrial Park, Qiaotou Community, Fuhai Street, Bao'an District, Shenzhen, China

**TEST REPORT
FCC Rules and Regulations Part PART 15.249**

Report Reference No.....: CTA22120100401

FCC ID.....: 2AYCU-S911

Compiled by
(position+printed name+signature .. File administrators Zoey Cao

Supervised by
(position+printed name+signature .. Project Engineer Amy Wen

Approved by
(position+printed name+signature .. RF Manager Eric Wang

Date of issue Dec. 14, 2022

Testing Laboratory Name Shenzhen CTA Testing Technology Co., Ltd.

Address Room 106, Building 1, Yibaolai Industrial Park, Qiaotou Community, Fuhai Street, Bao'an District, Shenzhen, China

Applicant's name WOHUA TOYS FACTORY

Address MIDDLE OF YUTING ROAD, CHENGHAI DISTRICT, SHANTOU CITY, GUANGDONG, PROVINCE, CHINA

Standard **FCC Rules and Regulations Part PART 15.249**

Shenzhen CTA Testing Technology Co., Ltd. All rights reserved.

This publication may be reproduced in whole or in part for non-commercial purposes as long as the Shenzhen CTA Testing Technology Co., Ltd. is acknowledged as copyright owner and source of the material. Shenzhen CTA Testing Technology Co., Ltd. takes no responsibility for and will not assume liability for damages resulting from the reader's interpretation of the reproduced material due to its placement and context.

Test item description..... R/C TOY CAR

Trade Mark..... N/A

Manufacturer..... WOHUA TOYS FACTORY

Model/Type reference..... S911

Listed Models S618, S628,S638, S658, S801, S802, S688, S688-1, S912, S913, S914, S915, S916, S917, S918, S919, S811, S812, S813

Modulation GFSK

Frequency 2407-2477MHz

Ratings..... DC 3V From Battery

Result..... **PASS**

TEST REPORT

Equipment under Test : R/C TOY CAR

Model /Type : S911

Listed Models : S618, S628,S638, S658, S801, S802, S688, S688-1, S912, S913, S914, S915, S916, S917, S918, S919, S811, S812, S813

Applicant : **WOHUA TOYS FACTORY**

Address : MIDDLE OF YUTING ROAD, CHENGHAI DISTRICT, SHANTOU CITY, GUANGDONG, PROVINCE, CHINA

Manufacturer : **WOHUA TOYS FACTORY**

Address : MIDDLE OF YUTING ROAD, CHENGHAI DISTRICT, SHANTOU CITY, GUANGDONG, PROVINCE, CHINA

| | |
|---------------------|-------------|
| Test Result: | PASS |
|---------------------|-------------|

The test report merely corresponds to the test sample.
It is not permitted to copy extracts of these test result without the written permission of the test laboratory.

Contents

| | | |
|-----------|---|-----------|
| 1. | <u>..TEST STANDARDS.....</u> | 4 |
| 2. | <u>..SUMMARY.....</u> | 5 |
| 2.1. | General Remarks | 5 |
| 2.2. | Product Description | 5 |
| 2.3. | Equipment Under Test | 5 |
| 2.4. | Short description of the Equipment under Test (EUT) | 5 |
| 2.5. | EUT operation mode | 5 |
| 2.6. | Block Diagram of Test Setup | 7 |
| 2.7. | Modifications | 7 |
| 3. | <u>..TEST ENVIRONMENT.....</u> | 8 |
| 3.1. | Address of the test laboratory | 8 |
| 3.2. | Test Facility | 8 |
| 3.3. | Environmental conditions | 8 |
| 3.4. | Summary of measurement results | 9 |
| 3.5. | Statement of the measurement uncertainty | 9 |
| 3.6. | Equipments Used during the Test | 9 |
| 4. | <u>..TEST CONDITIONS AND RESULTS.....</u> | 11 |
| 4.1. | AC Power Conducted Emission..... | 11 |
| 4.2. | Radiated Emission and Band Edges..... | 12 |
| 4.3. | 20dB Bandwidth Measurement..... | 18 |
| 4.4. | Antenna Requirement..... | 20 |
| 5. | <u>..TEST SETUP PHOTOS OF THE EUT.....</u> | 21 |
| 6. | <u>..TEST PHOTOS OF THE EUT.....</u> | 22 |

1. TEST STANDARDS

The tests were performed according to following standards:

FCC Rules Part 15.249: Operation within the bands 902 - 928 MHz, 2400 - 2483.5 MHz, 5725 - 5875 MHz, and 24.0 - 24.25 GHz.

ANSI C63.10:2013 : American National Standard for Testing Unlicensed Wireless Devices

ANSI C63.4: 2014: –American National Standard for Methods of Measurement of Radio-Noise Emissions from Low-Voltage Electrical and Electronic Equipment in the Range of 9 kHz to 40GHz
Range of 9 kHz to 40GHz

2. SUMMARY

2.1. General Remarks

| | | |
|--------------------------------|---|---------------|
| Date of receipt of test sample | : | Dec. 01, 2022 |
| Testing commenced on | : | Dec. 01, 2022 |
| Testing concluded on | : | Dec. 14, 2022 |

2.2. Product Description

| | |
|-----------------------|---|
| Product Name: | R/C TOY CAR |
| Trade Mark: | N/A |
| Model/Type reference: | S911 |
| Power Rating | DC 3V From Battery |
| Sample ID: | CTA221201004-1#(Engineer sample) CTA221201004-2#(Normal sample) |
| Operation frequency | 2407-2477MHz |
| Modulation | GFSK |
| Antenna Type | Internal antenna |
| Antenna Gain | 0dBi (Max) |
| Note: | The remote control only has the transmitting function, and the car only has the receiving function. |

2.3. Equipment Under Test

Power supply system utilised

| | | | |
|----------------------|---|---|-----------------------------------|
| Power supply voltage | : | <input type="radio"/> 230V / 50 Hz | <input type="radio"/> 120V / 60Hz |
| | | <input type="radio"/> 12 V DC | <input type="radio"/> 24 V DC |
| | | <input checked="" type="radio"/> Other (specified in blank below) | |

DC 3V From Battery

2.4. Short description of the Equipment under Test (EUT)

This is a R/C TOY CAR.

For more details, refer to the user's manual of the EUT.

2.5. EUT operation mode

The Applicant use Key to control the EUT for staying in continuous transmitting for testing .There is 3 channels provided to the EUT. Channel 3 was selected to test.

| Channel | Frequency (MHz) |
|---------|-----------------|
| 01 | 2407 |
| 02 | 2447 |
| 03 | 2477 |

Test frequency:

| Channel | Frequency (MHz) |
|---------|-----------------|
| Low | 2407 |
| Mid | 2447 |
| High | 2477 |

2.6. Block Diagram of Test Setup

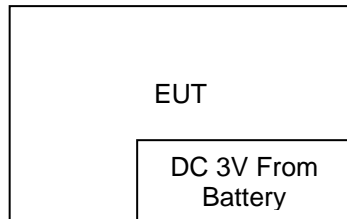

2.7. Modifications

No modifications were implemented to meet testing criteria.

3. TEST ENVIRONMENT

3.1. Address of the test laboratory

Shenzhen CTA Testing Technology Co., Ltd.

Room 106, Building 1, Yibaolai Industrial Park, Qiaotou Community, Fuhai Street, Bao'an District, Shenzhen, China

3.2. Test Facility

The test facility is recognized, certified, or accredited by the following organizations:

FCC-Registration No.: 517856 Designation Number: CN1318

Shenzhen CTA Testing Technology Co., Ltd. has been listed on the US Federal Communications Commission list of test facilities recognized to perform electromagnetic emissions measurements.

Industry Canada Registration Number. Is: 27890 CAB identifier: CN0127

The Laboratory has been registered by Certification and Engineering Bureau of Industry Canada for radio equipment testing.

A2LA-Lab Cert. No.: 6534.01

Shenzhen CTA Testing Technology Co., Ltd. has been listed by American Association for Laboratory Accreditation to perform electromagnetic emission measurement.

The 3m-Semi anechoic test site fulfils CISPR 16-1-4 according to ANSI C63.10 and CISPR 16-1-4:2010.

3.3. Environmental conditions

During the measurement the environmental conditions were within the listed ranges:

Radiated Emission:

| | |
|-----------------------|--------------|
| Temperature: | 23 ° C |
| Humidity: | 48 % |
| Atmospheric pressure: | 950-1050mbar |

AC Main Conducted testing:

| | |
|-----------------------|--------------|
| Temperature: | 24 ° C |
| Humidity: | 45 % |
| Atmospheric pressure: | 950-1050mbar |

Conducted testing:

| | |
|-----------------------|--------------|
| Temperature: | 24 ° C |
| Humidity: | 45 % |
| Atmospheric pressure: | 950-1050mbar |

3.4. Summary of measurement results

| FCC PART 15.249 | | |
|--------------------|-------------------------------|------|
| FCC Part 15.249(a) | Field Strength of Fundamental | PASS |
| FCC Part 15.209 | Spurious Emission | PASS |
| FCC Part 15.209 | Band edge | PASS |
| FCC Part 15.215(c) | 20dB bandwidth | PASS |
| FCC Part 15.207 | Conducted Emission | N/A |
| FCC Part 15.203 | Antenna Requirement | PASS |

3.5. Statement of the measurement uncertainty

Measurement Uncertainty

Conducted Emission Expanded Uncertainty = 2.23dB, k=2

Radiated emission expanded uncertainty(9kHz-30MHz) = 3.08dB, k=2

Radiated emission expanded uncertainty(30MHz-1000MHz) = 4.42dB, k=2

Radiated emission expanded uncertainty(Above 1GHz) = 4.06dB, k=2

3.6. Equipments Used during the Test

| Test Equipment | Manufacturer | Model No. | Equipment No. | Calibration Date | Calibration Due Date |
|--------------------------------|------------------------|------------|---------------|------------------|----------------------|
| LISN | R&S | ENV216 | CTA-308 | 2022/08/03 | 2023/08/02 |
| LISN | R&S | ENV216 | CTA-314 | 2022/08/03 | 2023/08/02 |
| EMI Test Receiver | R&S | ESPI | CTA-307 | 2022/08/03 | 2023/08/02 |
| EMI Test Receiver | R&S | ESCI | CTA-306 | 2022/08/03 | 2023/08/02 |
| Spectrum Analyzer | Agilent | N9020A | CTA-301 | 2022/08/03 | 2023/08/02 |
| Spectrum Analyzer | R&S | FSP | CTA-337 | 2022/08/03 | 2023/08/02 |
| Vector Signal generator | Agilent | N5182A | CTA-305 | 2022/08/03 | 2023/08/02 |
| Analog Signal Generator | R&S | SML03 | CTA-304 | 2022/08/03 | 2023/08/02 |
| Universal Radio Communication | CMW500 | R&S | CTA-302 | 2022/08/03 | 2023/08/02 |
| Temperature and humidity meter | Chigo | ZG-7020 | CTA-326 | 2022/08/03 | 2023/08/02 |
| Ultra-Broadband Antenna | Schwarzbeck | VULB9163 | CTA-310 | 2021/08/07 | 2024/08/06 |
| Horn Antenna | Schwarzbeck | BBHA 9120D | CTA-309 | 2021/08/07 | 2024/08/06 |
| Loop Antenna | Zhinan | ZN30900C | CTA-311 | 2021/08/07 | 2024/08/06 |
| Horn Antenna | Beijing Hangwei Dayang | OBH100400 | CTA-336 | 2021/08/07 | 2024/08/06 |
| Amplifier | Schwarzbeck | BBV 9745 | CTA-312 | 2022/08/03 | 2023/08/02 |

| | | | | | |
|-----------------------|----------------|-------------|---------|------------|------------|
| Amplifier | Taiwan chengyi | EMC051845B | CTA-313 | 2022/08/03 | 2023/08/02 |
| Directional coupler | NARDA | 4226-10 | CTA-303 | 2022/08/03 | 2023/08/02 |
| High-Pass Filter | XingBo | XBLBQ-GTA18 | CTA-402 | 2022/08/03 | 2023/08/02 |
| High-Pass Filter | XingBo | XBLBQ-GTA27 | CTA-403 | 2022/08/03 | 2023/08/02 |
| Automated filter bank | Tonscend | JS0806-F | CTA-404 | 2022/08/03 | 2023/08/02 |
| Power Sensor | Agilent | U2021XA | CTA-405 | 2022/08/03 | 2023/08/02 |
| Amplifier | Schwarzbeck | BBV9719 | CTA-406 | 2022/08/03 | 2023/08/02 |

4. TEST CONDITIONS AND RESULTS

4.1. AC Power Conducted Emission

TEST CONFIGURATION

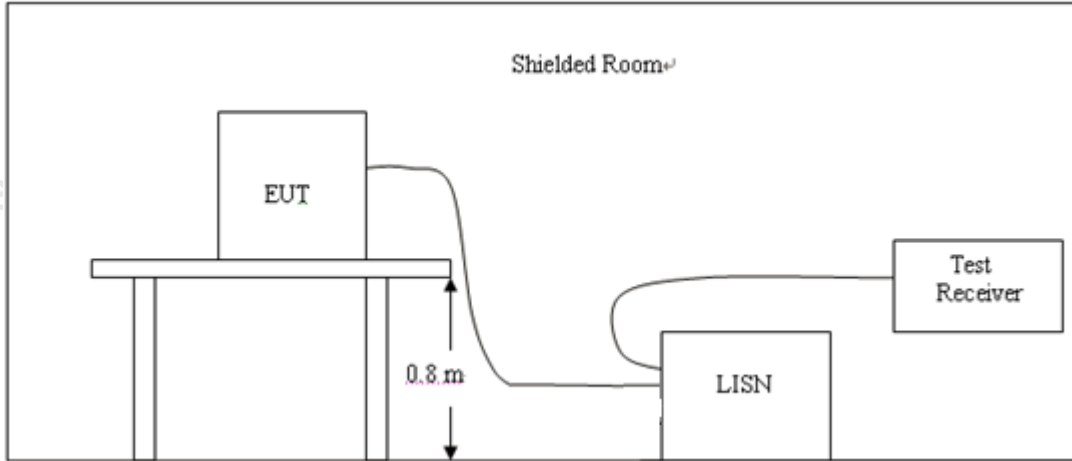

TEST PROCEDURE

- 1, The equipment was set up as per the test configuration to simulate typical actual usage per the user's manual. The EUT is a tabletop system, a wooden table with a height of 0.8 meters is used and is placed on the ground plane as per ANSI C63.10.
- 2, Support equipment, if needed, was placed as per ANSI C63.10.
- 3, All I/O cables were positioned to simulate typical actual usage as per ANSI C63.10.
- 4, If a EUT received DC power from the USB Port of Notebook PC, the PC's adapter received power through a Line Impedance Stabilization Network (LISN) which supplied power source and was grounded to the ground plane.
- 5, All support equipments received AC power from a second LISN, if any.
- 6, The EUT test program was started. Emissions were measured on each current carrying line of the EUT using a spectrum Analyzer / Receiver connected to the LISN powering the EUT. The LISN has two monitoring points: Line 1 (Hot Side) and Line 2 (Neutral Side). Two scans were taken: one with Line 1 connected to Analyzer / Receiver and Line 2 connected to a 50 ohm load; the second scan had Line 1 connected to a 50 ohm load and Line 2 connected to the Analyzer / Receiver.
- 7, Analyzer / Receiver scanned from 150 KHz to 30MHz for emissions in each of the test modes.

AC Power Conducted Emission Limit

For intentional device, according to § 15.207(a) AC Power Conducted Emission Limits is as following :

| Frequency range (MHz) | Limit (dBuV) | |
|-----------------------|--------------|-----------|
| | Quasi-peak | Average |
| 0.15-0.5 | 66 to 56* | 56 to 46* |
| 0.5-5 | 56 | 46 |
| 5-30 | 60 | 50 |

* Decreases with the logarithm of the frequency.

TEST RESULTS

The EUT is powered by the Battery, So this test item is not applicable for the EUT.

4.2. Radiated Emission and Band Edges

TEST CONFIGURATION

Frequency range 9 KHz – 30MHz

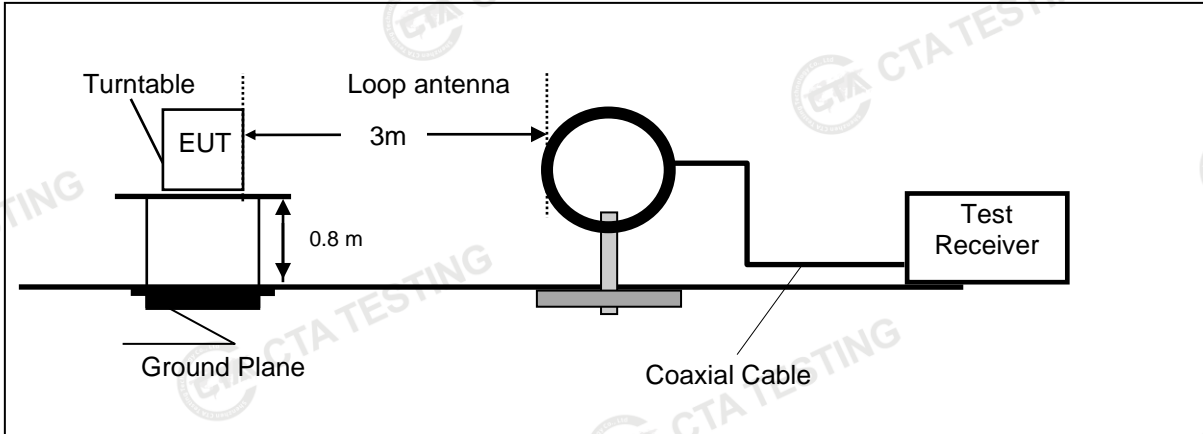

Frequency range 30MHz – 1000MHz

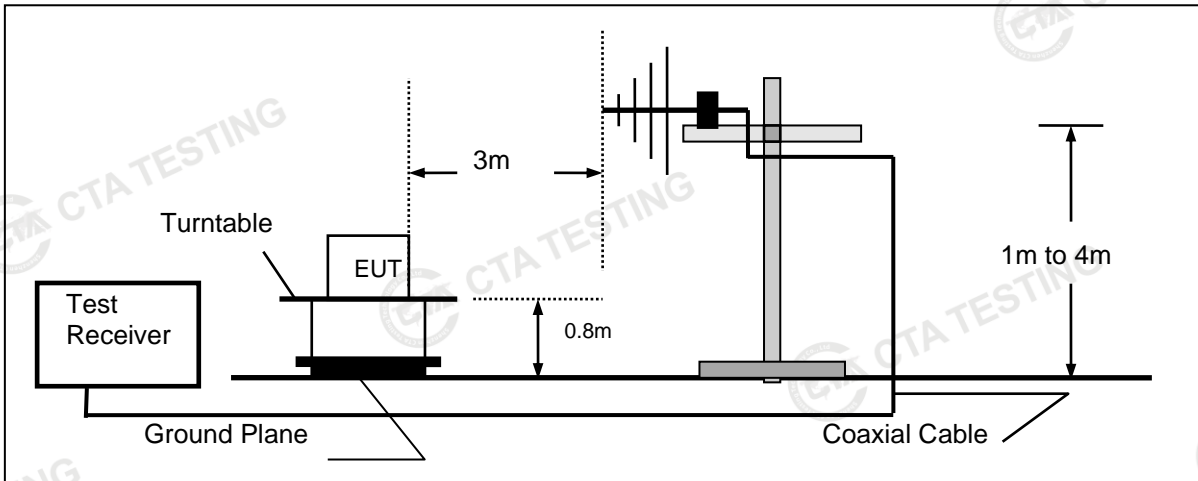

Frequency range above 1GHz-25GHz

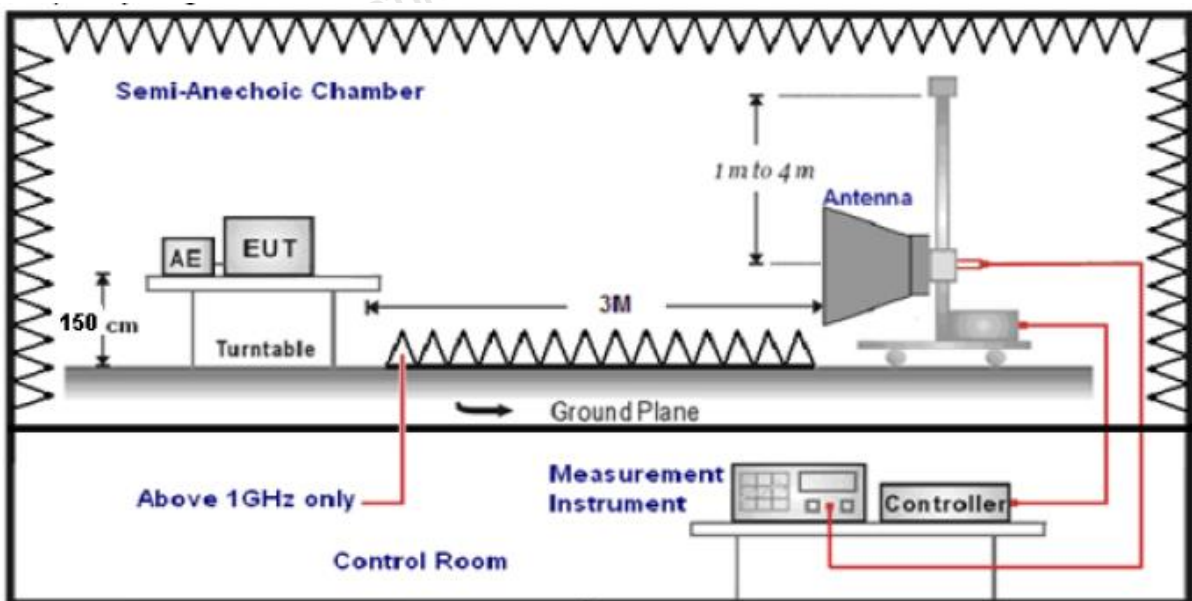

TEST PROCEDURE

1. The EUT was placed on a turn table which is 0.8m above ground plane when testing frequency range 9 KHz –25GHz.
2. Maximum procedure was performed by raising the receiving antenna from 1m to 4m and rotating the turn table from 0°C to 360°C to acquire the highest emissions from EUT.
3. And also, each emission was to be maximized by changing the polarization of receiving antenna both horizontal and vertical.
4. Repeat above procedures until all frequency measurements have been completed.
5. The EUT minimum operation frequency was 26MHz and maximum operation frequency was 1910MHz.so radiated emission test frequency band from 9KHz to 25GHz.
6. The distance between test antenna and EUT as following table states:

| Test Frequency range | Test Antenna Type | Test Distance |
|----------------------|----------------------------|---------------|
| 9KHz-30MHz | Active Loop Antenna | 3 |
| 30MHz-1GHz | Ultra-Broadband Antenna | 3 |
| 1GHz-18GHz | Double Ridged Horn Antenna | 3 |
| 18GHz-25GHz | Horn Antenna | 1 |

7. Setting test receiver/spectrum as following table states:

| Test Frequency range | Test Receiver/Spectrum Setting | Detector |
|----------------------|---|----------|
| 9KHz-150KHz | RBW=200Hz/VBW=3KHz, Sweep time=Auto | QP |
| 150KHz-30MHz | RBW=9KHz/VBW=100KHz, Sweep time=Auto | QP |
| 30MHz-1GHz | RBW=120KHz/VBW=1000KHz, Sweep time=Auto | QP |
| 1GHz-40GHz | Peak Value: RBW=1MHz/VBW=3MHz, Sweep time=Auto Average Value: RBW=1MHz/VBW=10Hz, Sweep time=Auto | Peak |

Field Strength Calculation

The field strength is calculated by adding the Antenna Factor and Cable Factor and subtracting the Amplifier Gain and Duty Cycle Correction Factor(if any) from the measured reading. The basic equation with a sample calculation is as follows:

FS = RA + AF + CL - AG

| | |
|---------------------------|--|
| Where FS = Field Strength | CL = Cable Attenuation Factor (Cable Loss) |
| RA = Reading Amplitude | AG = Amplifier Gain |
| AF = Antenna Factor | |

Transd=AF +CL-AG

RADIATION LIMIT

According 15.249, the field strength of emissions from intentional radiators operated within 2400MHz-2483.5 MHz shall not exceed 94dBµV/m (50mV/m):

FCC PART 15.249(d) Emissions radiated outside of the specified frequency bands, except for harmonics, shall be attenuated by at least 50 dB below the level of the fundamental or to the general radiated emission limits in §15.209, whichever is the lesser attenuation.

In addition, radiated emissions which fall in the restricted bands, as defined in §15.205(a), must also comply with the radiated emission limits specified in §15.209(a)

Radiated emission limits

| Frequency (MHz) | Distance (Meters) | Radiated (dBµV/m) | Radiated (µV/m) |
|-----------------|-------------------|----------------------------------|-----------------|
| 0.009-0.49 | 3 | 20log(2400/F(KHz))+40log(300/3) | 2400/F(KHz) |
| 0.49-1.705 | 3 | 20log(24000/F(KHz))+ 40log(30/3) | 24000/F(KHz) |
| 1.705-30 | 3 | 20log(30)+ 40log(30/3) | 30 |
| 30-88 | 3 | 40.0 | 100 |
| 88-216 | 3 | 43.5 | 150 |
| 216-960 | 3 | 46.0 | 200 |
| Above 960 | 3 | 54.0 | 500 |

TEST RESULTS

Remark:

1. This test was performed with EUT in X, Y, Z position and the worse case was found when EUT in X position.
2. Both modes of GFSK were tested at Low, Middle, and High channel and recorded worst mode at GFSK
3. Radiated emission test from 9 KHz to 10th harmonic of fundamental was verified, and no emission found except system noise floor in 9 KHz to 30MHz and not recorded in this report.

For 30MHz-1GHz

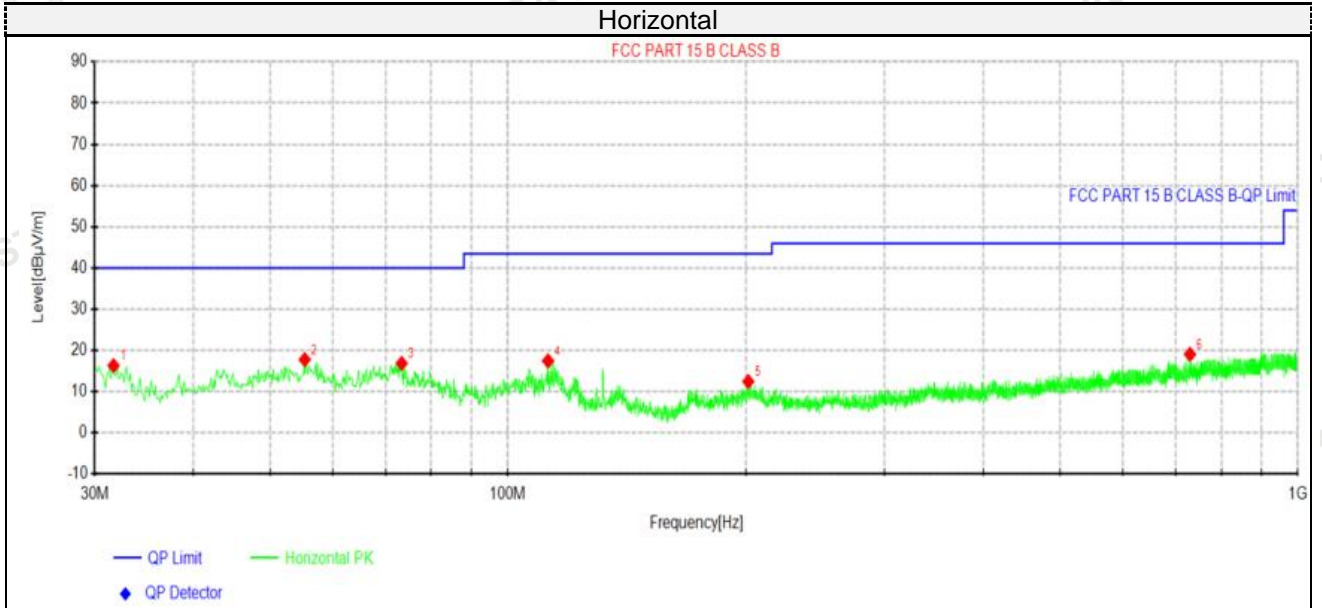

Suspected Data List

| NO. | Freq. [MHz] | Reading [dBµV] | Level [dBµV/m] | Factor [dB/m] | Limit [dBµV/m] | Margin [dB] | Height [cm] | Angle [°] | Polarity |
|-----|-------------|----------------|----------------|---------------|----------------|-------------|-------------|-----------|------------|
| 1 | 31.6975 | 34.81 | 16.35 | -18.46 | 40.00 | 23.65 | 100 | 40 | Horizontal |
| 2 | 55.3412 | 35.02 | 17.81 | -17.21 | 40.00 | 22.19 | 100 | 70 | Horizontal |
| 3 | 73.4075 | 37.90 | 16.87 | -21.03 | 40.00 | 23.13 | 100 | 200 | Horizontal |
| 4 | 112.45 | 36.68 | 17.48 | -19.20 | 43.50 | 26.02 | 100 | 310 | Horizontal |
| 5 | 201.568 | 31.75 | 12.49 | -19.26 | 43.50 | 31.01 | 100 | 350 | Horizontal |
| 6 | 730.34 | 30.21 | 19.08 | -11.13 | 46.00 | 26.92 | 100 | 250 | Horizontal |

- Note:1). Level (dBµV/m) = Reading (dBµV) + Factor (dB/m)
 2). Factor (dB/m) = Antenna Factor (dB/m) + Cable loss (dB) - Pre Amplifier gain (dB)
 3). Margin (dB) = Limit (dBµV/m) - Level (dBµV/m)

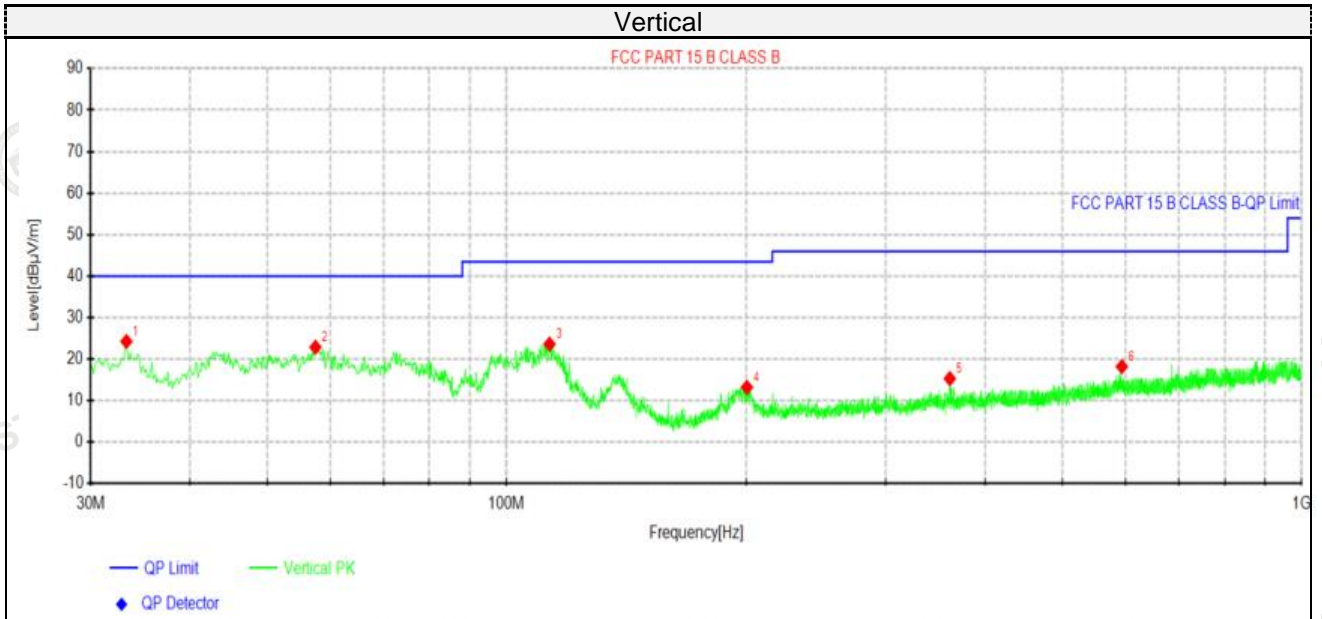

Suspected Data List

| NO. | Freq. [MHz] | Reading [dBµV] | Level [dBµV/m] | Factor [dB/m] | Limit [dBµV/m] | Margin [dB] | Height [cm] | Angle [°] | Polarity |
|-----|-------------|----------------|----------------|---------------|----------------|-------------|-------------|-----------|----------|
| 1 | 33.2738 | 42.46 | 24.30 | -18.16 | 40.00 | 15.70 | 100 | 90 | Vertical |
| 2 | 57.5238 | 40.58 | 22.90 | -17.68 | 40.00 | 17.10 | 100 | 50 | Vertical |
| 3 | 113.298 | 42.96 | 23.63 | -19.33 | 43.50 | 19.87 | 100 | 240 | Vertical |
| 4 | 200.598 | 32.50 | 13.22 | -19.28 | 43.50 | 30.28 | 100 | 300 | Vertical |
| 5 | 361.012 | 31.26 | 15.33 | -15.93 | 46.00 | 30.67 | 100 | 30 | Vertical |
| 6 | 594.055 | 30.63 | 18.23 | -12.40 | 46.00 | 27.77 | 100 | 70 | Vertical |

Note:1). Level (dBµV/m)= Reading (dBµV)+ Factor (dB/m)

2). Factor(dB/m)=Antenna Factor (dB/m) + Cable loss (dB) - Pre Amplifier gain (dB)

3). Margin(dB) = Limit (dBµV/m) - Level (dBµV/m)

For 1GHz to 25GHz

GFSK (above 1GHz)

| Frequency(MHz): | | | 2407 | | Polarity: | | HORIZONTAL | | |
|-----------------|-------------------------|----|----------------|-------------|------------------|-----------------------|-------------------|--------------------|--------------------------|
| Frequency (MHz) | Emission Level (dBuV/m) | | Limit (dBuV/m) | Margin (dB) | Raw Value (dBuV) | Antenna Factor (dB/m) | Cable Factor (dB) | Pre-amplifier (dB) | Correction Factor (dB/m) |
| 2407.00 | 97.30 | PK | 114.00 | 16.70 | 108.58 | 27.48 | 3.43 | 42.19 | -11.28 |
| 2407.00 | 78.85 | AV | 94.00 | 15.15 | 90.13 | 27.48 | 3.43 | 42.19 | -11.28 |
| 4814.00 | 47.74 | PK | 74.00 | 26.26 | 51.99 | 32.34 | 5.16 | 41.75 | -4.25 |
| 4814.00 | 38.77 | AV | 54.00 | 15.23 | 43.02 | 32.34 | 5.16 | 41.75 | -4.25 |
| 7221.00 | 48.73 | PK | 74.00 | 25.27 | 49.26 | 36.61 | 6.52 | 43.66 | -0.53 |
| 7221.00 | 35.83 | AV | 54.00 | 18.17 | 36.36 | 36.61 | 6.52 | 43.66 | -0.53 |

| Frequency(MHz): | | | 2407 | | Polarity: | | VERTICAL | | |
|-----------------|-------------------------|----|----------------|-------------|------------------|-----------------------|-------------------|--------------------|--------------------------|
| Frequency (MHz) | Emission Level (dBuV/m) | | Limit (dBuV/m) | Margin (dB) | Raw Value (dBuV) | Antenna Factor (dB/m) | Cable Factor (dB) | Pre-amplifier (dB) | Correction Factor (dB/m) |
| 2407.00 | 94.77 | PK | 114.00 | 19.23 | 106.05 | 27.48 | 3.43 | 42.19 | -11.28 |
| 2407.00 | 76.32 | AV | 94.00 | 17.68 | 87.60 | 27.48 | 3.43 | 42.19 | -11.28 |
| 4814.00 | 45.21 | PK | 74.00 | 28.79 | 49.46 | 32.34 | 5.16 | 41.75 | -4.25 |
| 4814.00 | 36.24 | AV | 54.00 | 17.76 | 40.49 | 32.34 | 5.16 | 41.75 | -4.25 |
| 7221.00 | 46.20 | PK | 74.00 | 27.80 | 46.73 | 36.61 | 6.52 | 43.66 | -0.53 |
| 7221.00 | 33.30 | AV | 54.00 | 20.70 | 33.83 | 36.61 | 6.52 | 43.66 | -0.53 |

| Frequency(MHz): | | | 2447 | | Polarity: | | HORIZONTAL | | |
|-----------------|-------------------------|----|----------------|-------------|------------------|-----------------------|-------------------|--------------------|--------------------------|
| Frequency (MHz) | Emission Level (dBuV/m) | | Limit (dBuV/m) | Margin (dB) | Raw Value (dBuV) | Antenna Factor (dB/m) | Cable Factor (dB) | Pre-amplifier (dB) | Correction Factor (dB/m) |
| 2447.00 | 97.09 | PK | 114.00 | 16.92 | 108.32 | 27.53 | 3.47 | 42.23 | -11.23 |
| 2447.00 | 79.17 | AV | 94.00 | 14.84 | 90.40 | 27.53 | 3.47 | 42.23 | -11.23 |
| 4894.00 | 50.29 | PK | 74.00 | 23.72 | 54.13 | 32.64 | 5.35 | 41.83 | -3.84 |
| 4894.00 | 45.60 | AV | 54.00 | 8.40 | 49.44 | 32.64 | 5.35 | 41.83 | -3.84 |
| 7341.00 | 50.62 | PK | 74.00 | 23.39 | 50.71 | 36.83 | 6.82 | 43.74 | -0.09 |
| 7341.00 | 38.44 | AV | 54.00 | 15.57 | 38.53 | 36.83 | 6.82 | 43.74 | -0.09 |

| Frequency(MHz): | | | 2447 | | Polarity: | | VERTICAL | | |
|-----------------|-------------------------|----|----------------|-------------|------------------|-----------------------|-------------------|--------------------|--------------------------|
| Frequency (MHz) | Emission Level (dBuV/m) | | Limit (dBuV/m) | Margin (dB) | Raw Value (dBuV) | Antenna Factor (dB/m) | Cable Factor (dB) | Pre-amplifier (dB) | Correction Factor (dB/m) |
| 2447.00 | 94.33 | PK | 114.00 | 19.67 | 105.56 | 27.53 | 3.47 | 42.23 | -11.23 |
| 2447.00 | 76.41 | AV | 94.00 | 17.59 | 87.64 | 27.53 | 3.47 | 42.23 | -11.23 |
| 4894.00 | 47.53 | PK | 74.00 | 26.47 | 51.37 | 32.64 | 5.35 | 41.83 | -3.84 |
| 4894.00 | 42.84 | AV | 54.00 | 11.16 | 46.68 | 32.64 | 5.35 | 41.83 | -3.84 |
| 7341.00 | 47.86 | PK | 74.00 | 26.14 | 47.95 | 36.83 | 6.82 | 43.74 | -0.09 |
| 7341.00 | 35.68 | AV | 54.00 | 18.32 | 35.77 | 36.83 | 6.82 | 43.74 | -0.09 |

| Frequency(MHz): | | | 2477 | | Polarity: | | HORIZONTAL | | |
|-----------------|-------------------------|----|----------------|-------------|------------------|-----------------------|-------------------|--------------------|--------------------------|
| Frequency (MHz) | Emission Level (dBuV/m) | | Limit (dBuV/m) | Margin (dB) | Raw Value (dBuV) | Antenna Factor (dB/m) | Cable Factor (dB) | Pre-amplifier (dB) | Correction Factor (dB/m) |
| 2477.00 | 96.56 | PK | 114.00 | 17.44 | 107.79 | 27.53 | 3.47 | 42.23 | -11.23 |
| 2477.00 | 79.01 | AV | 94.00 | 14.99 | 90.24 | 27.53 | 3.47 | 42.23 | -11.23 |
| 4954.00 | 50.67 | PK | 74.00 | 23.33 | 54.51 | 32.64 | 5.35 | 41.83 | -3.84 |
| 4954.00 | 44.57 | AV | 54.00 | 9.43 | 48.41 | 32.64 | 5.35 | 41.83 | -3.84 |
| 7431.00 | 50.42 | PK | 74.00 | 23.58 | 50.51 | 36.83 | 6.82 | 43.74 | -0.09 |
| 7431.00 | 37.87 | AV | 54.00 | 16.13 | 37.96 | 36.83 | 6.82 | 43.74 | -0.09 |

| Frequency(MHz): | | | 2477 | | Polarity: | | VERTICAL | | |
|-----------------|-------------------------|----|----------------|-------------|------------------|-----------------------|-------------------|--------------------|--------------------------|
| Frequency (MHz) | Emission Level (dBuV/m) | | Limit (dBuV/m) | Margin (dB) | Raw Value (dBuV) | Antenna Factor (dB/m) | Cable Factor (dB) | Pre-amplifier (dB) | Correction Factor (dB/m) |
| 2477.00 | 94.02 | PK | 114.00 | 19.98 | 105.25 | 27.53 | 3.47 | 42.23 | -11.23 |
| 2477.00 | 76.47 | AV | 94.00 | 17.53 | 87.70 | 27.53 | 3.47 | 42.23 | -11.23 |
| 4954.00 | 48.13 | PK | 74.00 | 25.87 | 51.97 | 32.64 | 5.35 | 41.83 | -3.84 |
| 4954.00 | 42.03 | AV | 54.00 | 11.97 | 45.87 | 32.64 | 5.35 | 41.83 | -3.84 |
| 7431.00 | 47.88 | PK | 74.00 | 26.12 | 47.97 | 36.83 | 6.82 | 43.74 | -0.09 |
| 7431.00 | 35.33 | AV | 54.00 | 18.67 | 35.42 | 36.83 | 6.82 | 43.74 | -0.09 |

REMARKS:

1. Emission level (dBuV/m) = Raw Value (dBuV) + Correction Factor (dB/m)
2. Correction Factor (dB/m) = Antenna Factor (dB/m) + Cable Factor (dB) - Pre-amplifier
3. Margin value = Limit value - Emission level.
4. -- Mean the PK detector measured value is below average limit.
5. The other emission levels were very low against the limit.

Results of Band Edges Test (Radiated)

| Frequency(MHz): | | | 2407 | | Polarity: | | HORIZONTAL | | |
|-----------------|-------------------------|----|----------------|-------------|------------------|-----------------------|-------------------|--------------------|--------------------------|
| Frequency (MHz) | Emission Level (dBuV/m) | | Limit (dBuV/m) | Margin (dB) | Raw Value (dBuV) | Antenna Factor (dB/m) | Cable Factor (dB) | Pre-amplifier (dB) | Correction Factor (dB/m) |
| 2390.00 | 58.35 | PK | 74 | 15.65 | 68.77 | 27.42 | 4.31 | 42.15 | -10.42 |
| 2390.00 | 40.31 | AV | 54 | 13.69 | 50.73 | 27.42 | 4.31 | 42.15 | -10.42 |
| Frequency(MHz): | | | 2407 | | Polarity: | | VERTICAL | | |
| Frequency (MHz) | Emission Level (dBuV/m) | | Limit (dBuV/m) | Margin (dB) | Raw Value (dBuV) | Antenna Factor (dB/m) | Cable Factor (dB) | Pre-amplifier (dB) | Correction Factor (dB/m) |
| 2390.00 | 56.13 | PK | 74 | 17.87 | 66.55 | 27.42 | 4.31 | 42.15 | -10.42 |
| 2390.00 | 38.09 | AV | 54 | 15.91 | 48.51 | 27.42 | 4.31 | 42.15 | -10.42 |
| Frequency(MHz): | | | 2477 | | Polarity: | | HORIZONTAL | | |
| Frequency (MHz) | Emission Level (dBuV/m) | | Limit (dBuV/m) | Margin (dB) | Raw Value (dBuV) | Antenna Factor (dB/m) | Cable Factor (dB) | Pre-amplifier (dB) | Correction Factor (dB/m) |
| 2483.50 | 58.41 | PK | 74 | 15.59 | 68.52 | 27.7 | 4.47 | 42.28 | -10.11 |
| 2483.50 | 39.52 | AV | 54 | 14.48 | 49.63 | 27.7 | 4.47 | 42.28 | -10.11 |
| Frequency(MHz): | | | 2477 | | Polarity: | | VERTICAL | | |
| Frequency (MHz) | Emission Level (dBuV/m) | | Limit (dBuV/m) | Margin (dB) | Raw Value (dBuV) | Antenna Factor (dB/m) | Cable Factor (dB) | Pre-amplifier (dB) | Correction Factor (dB/m) |
| 2483.50 | 55.66 | PK | 74 | 18.34 | 65.77 | 27.7 | 4.47 | 42.28 | -10.11 |
| 2483.50 | 36.77 | AV | 54 | 17.23 | 46.88 | 27.7 | 4.47 | 42.28 | -10.11 |

Note:

- 1) Emission level (dBuV/m) = Meter Reading + antenna Factor + cable loss - preamp factor.
- 2) Margin value = Limits - Emission level.
- 3) -- Mean the PK detector measured value is below average limit.
- 4) The other emission levels were very low against the limit.
- 5) RBW1MHz VBW3MHz Peak detector is for PK value; RBW 1MHz VBW10Hz Peak detector is for AV value.

4.3. 20dB Bandwidth Measurement

TEST CONFIGURATION



TEST PROCEDURE

The transmitter output was connected to the spectrum analyzer through an attenuator. The bandwidth of the fundamental frequency was measured by spectrum analyzer with 30KHz RBW and 300KHz VBW.

The 20dB bandwidth is defined as the total spectrum the power of which is higher than peak power minus 20dB.

LIMIT

N/A

TEST RESULTS

| Modulation | Channel | 20dB bandwidth (MHz) | Result |
|------------|---------|----------------------|--------|
| GFSK | Low | 1.282 | PASS |
| | Mid | 1.281 | |
| | High | 1.312 | |

Note: 1.The test results including the cable lose.

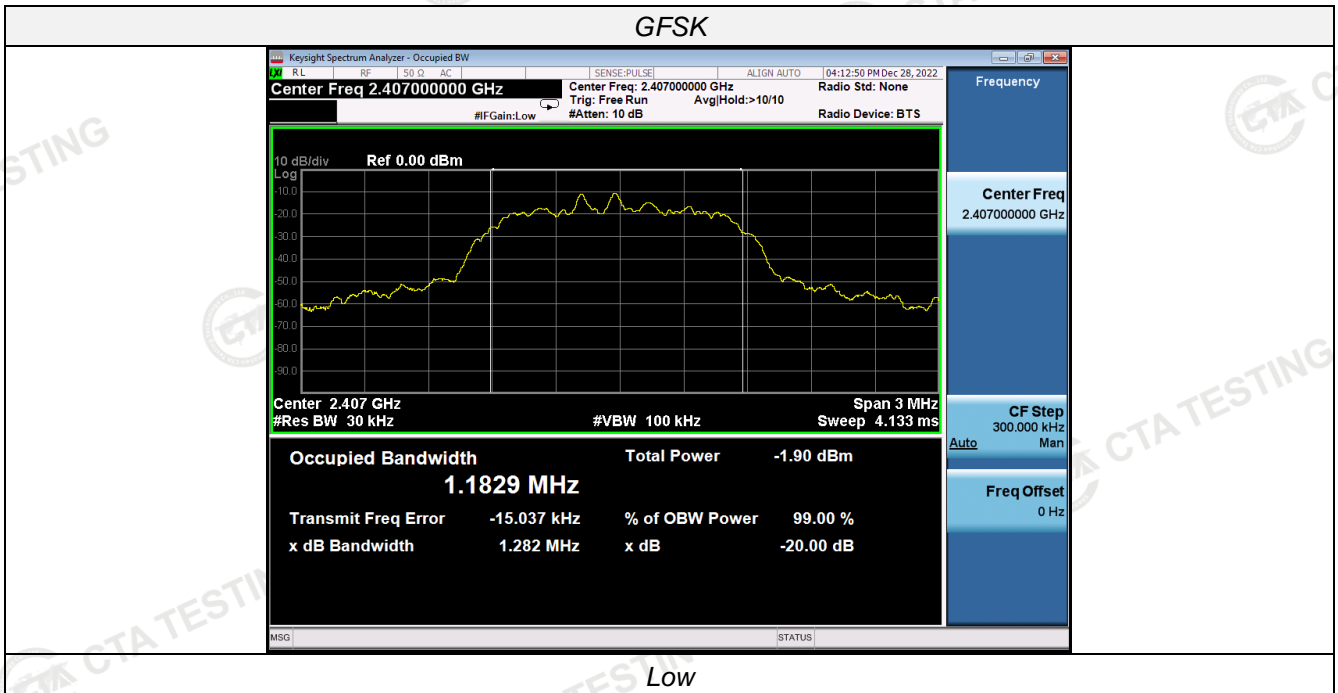

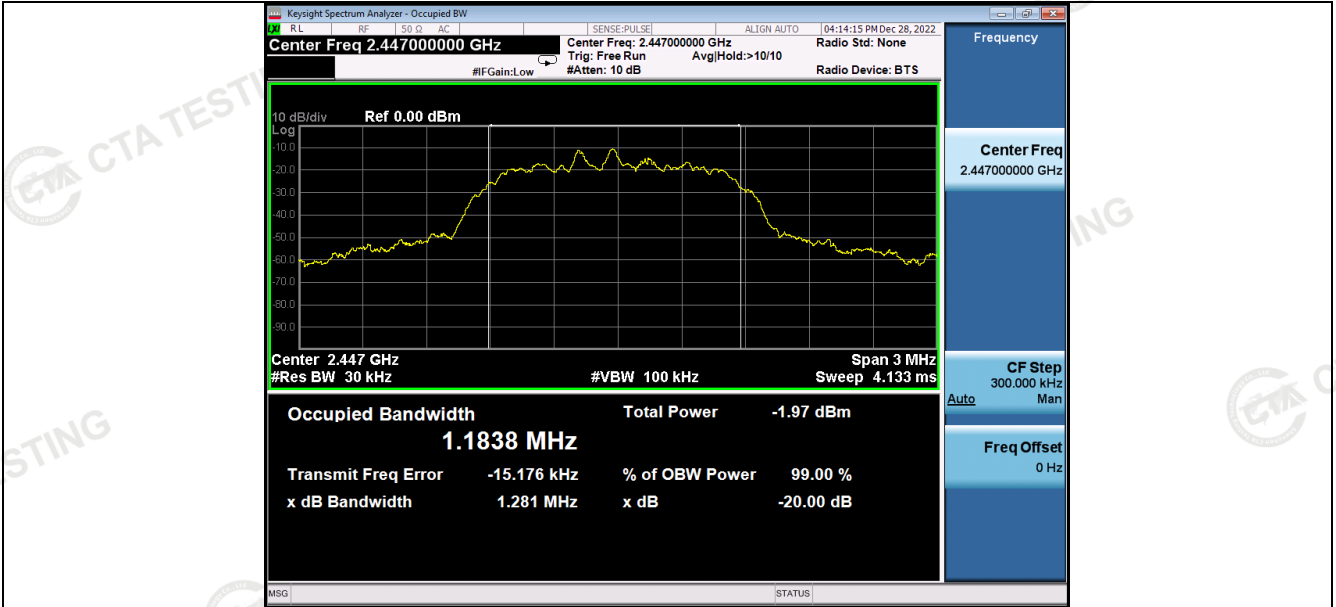

Mid

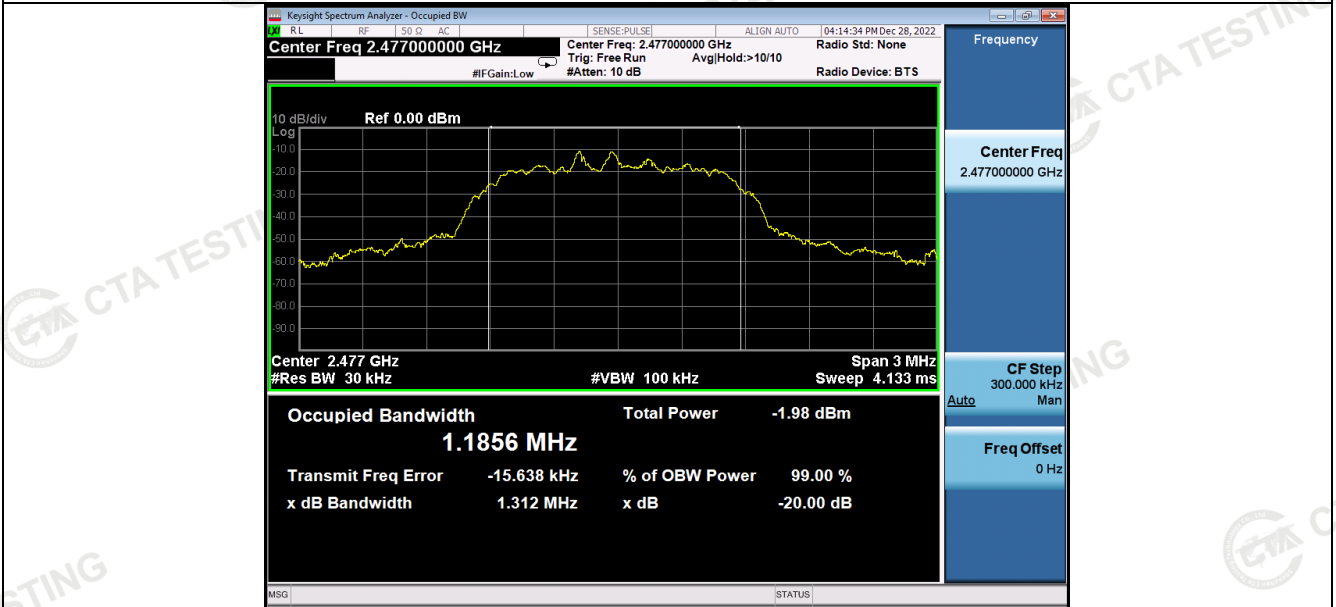

High

4.4. Antenna Requirement

Standard Applicable

For intentional device, according to FCC 47 CFR Section 15.203, an intentional radiator shall be designed to ensure that no antenna other than that furnished by the responsible party shall be used with the device.

And according to FCC 47 CFR Section 15.247 (c), if transmitting antennas of directional gain greater than 6dBi are used, the power shall be reduced by the amount in dB that the directional gain of the antenna exceeds 6dBi.

Antenna Information

The maximum gain of antenna was 0.0 dBi.

Remark: The antenna gain is provided by the customer, if the data provided by the customer is not accurate, Shenzhen CTA Testing Technology Co., Ltd. does not assume any responsibility.

5. Test Setup Photos of the EUT



6. Test Photos of the EUT







Antenna

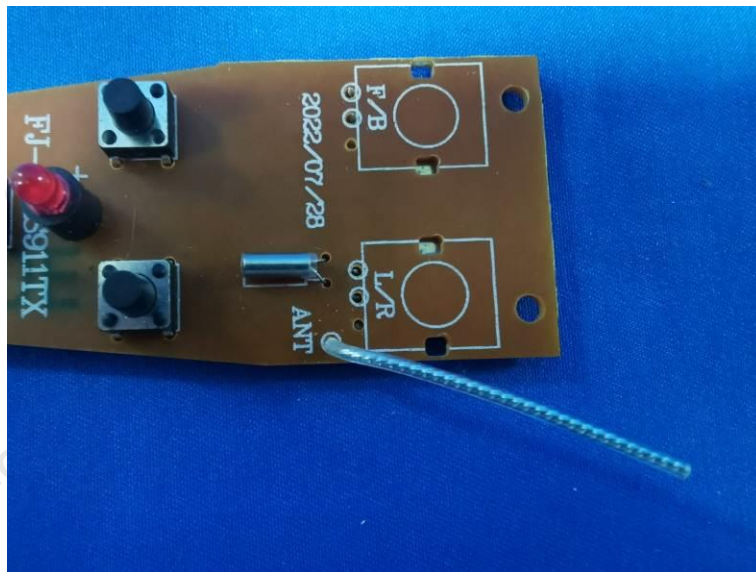
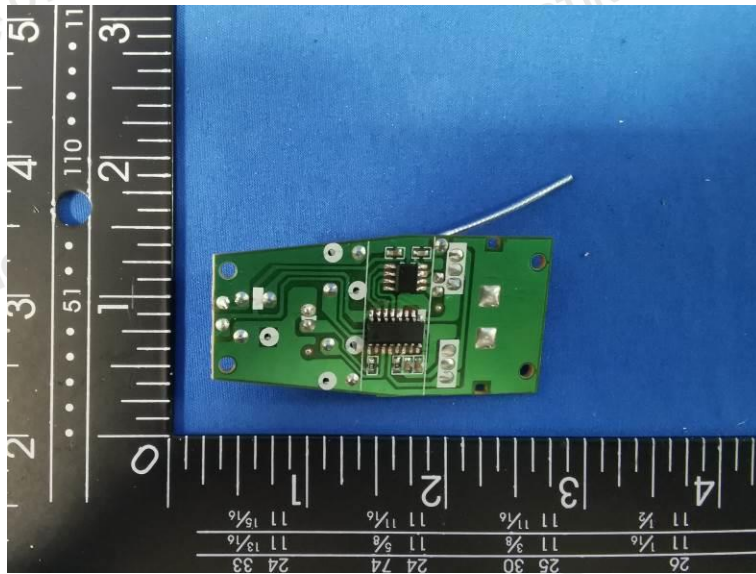
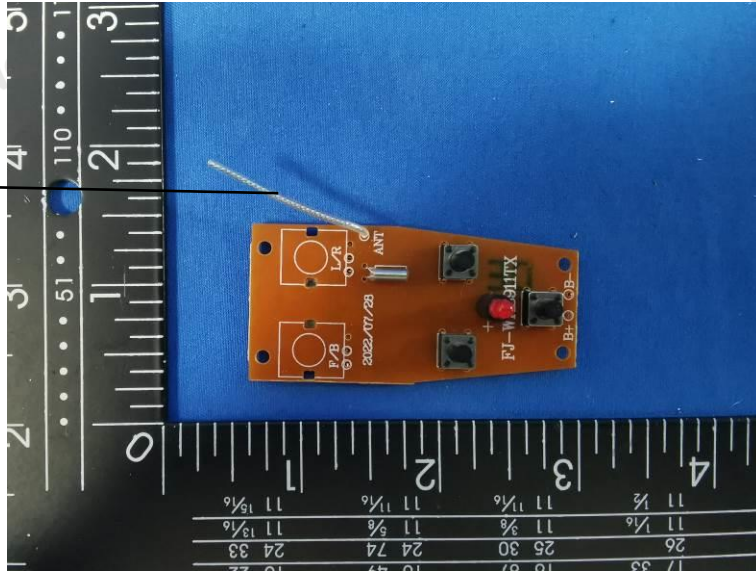



.....End of Report.....