

**TRU-BOLT®**  
**olympic**  
 Electronic Wifi Deadbolt with  
 Biometric Touchscreen

ENGLISH

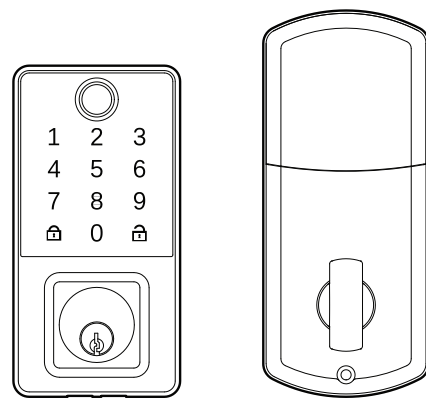

**Read this manual carefully before installing and operating!**

**Important**

Use the QR code below for the most up to date instructions:



**Tools Needed for Lock Installation:**

- Phillips Screwdriver



**1 Installation Overview**

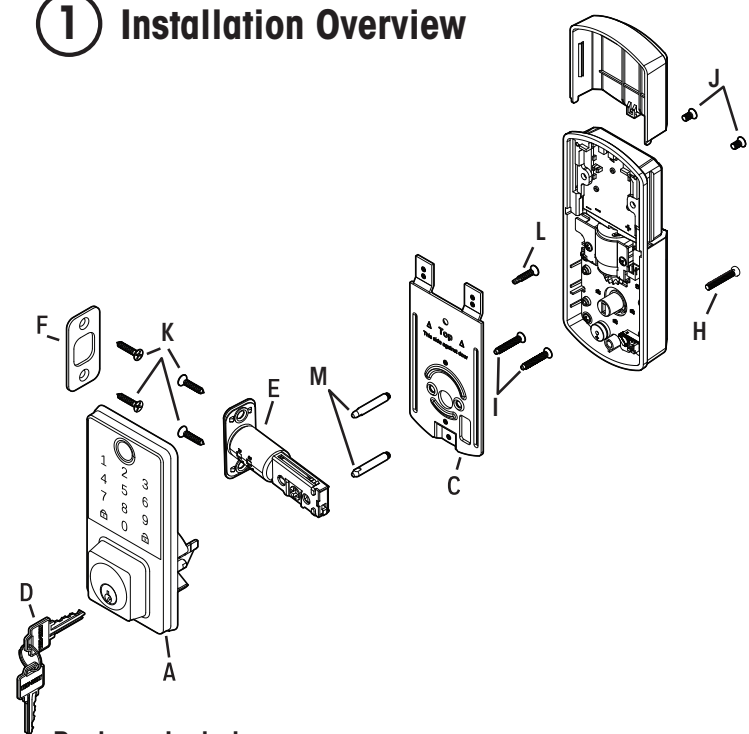

**Package Includes:**

- |                        |                    |                        |
|------------------------|--------------------|------------------------|
| 1 - Exterior Faceplate | 1 - Strike Plate   | 2 - 5/16" Screws       |
| 1 - Interior Faceplate | 1 - Mounting Plate | 2 - 1" Screws          |
| 1 - User Guide         | 1 - Latch          | 4 - 3/4" Screws        |
| 2 - Keys               | 1 - 1 3/8" Screws  | 2 - Mounting Post      |
|                        |                    | 1 - Optional Set Screw |

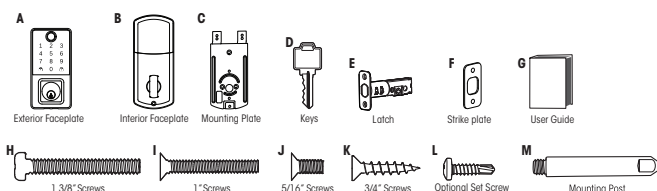

Please carefully check the above list to confirm all items have been received. If any items are missing, please contact Consumer Assistance. (See page for contact information)

Read this manual carefully before installing and operating!

**2 Install Enclosed Latch and Strike Plate.**  
**Do not over-tighten latch screws.**

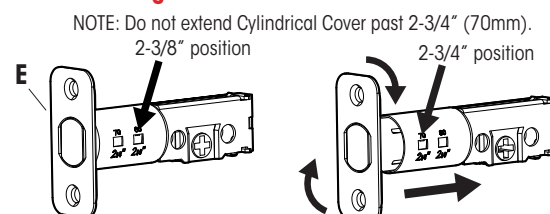

TO CONVERT FROM 2-3/8" (60mm) BACKSET TO 2-3/4" (70mm) BACKSET:  
 1. Hold latch with numbers facing forward and thumb pressing on the bolt.  
 2. Rotate the cylinder cover clockwise.  
 3. Pull and twist the extension plate all the way out.  
 4. Rotate the cylinder counter clockwise so that the marking aligns with the 2-3/4" position indicator.

**The latch plate on the door needs to be straight and not protruding from door. Make adjustment before installing or this will cause problems with bolt fitting into latch hole.**

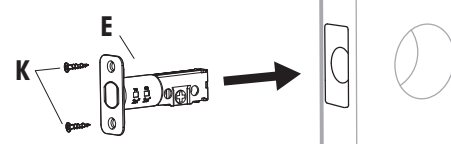

**Deadbolt Latch Must Be Retracted During Installation.**

**Preparation for Interior Assembly.**

Remove (J) Screw from inside the battery compartment within the (B) Housing to release the Mounting Plate (C).

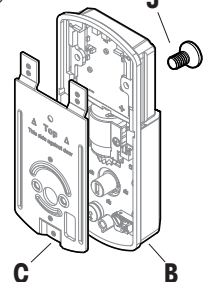

Screw Mounting Post (M) into holes on Mounting Plate (C).

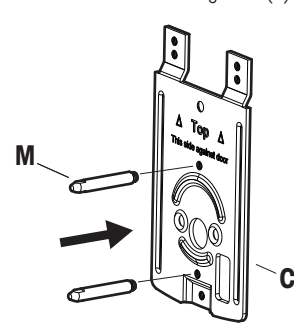

**3 Install Exterior Assembly**

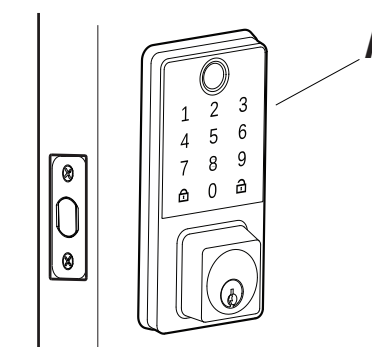

**Check that the Rubber Gasket is secured on the Exterior Assembly. Insert the Exterior Assembly onto the door with the tailpiece going through the Deadbolt Latch Set in the VERTICAL POSITION.**

Route the Control Wire through the door UNDER the Deadbolt Latch Set. **Make sure the door is shut, lock and unlock using the key, ensure that the latch is operating smoothly and is aligned properly without scraping the strike plate.** If not, go back to step 2 and ensure you followed the steps

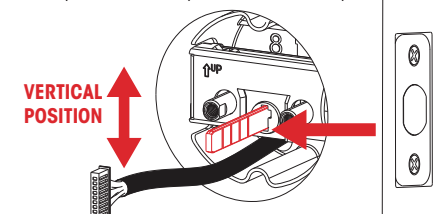

**Work with the door open**

(L) screw goes into the door to prevent the lock from shifting and is optional.

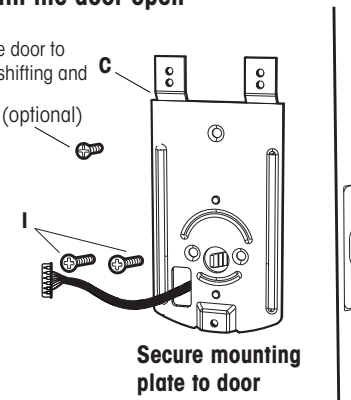

**4 Install Interior Assembly**

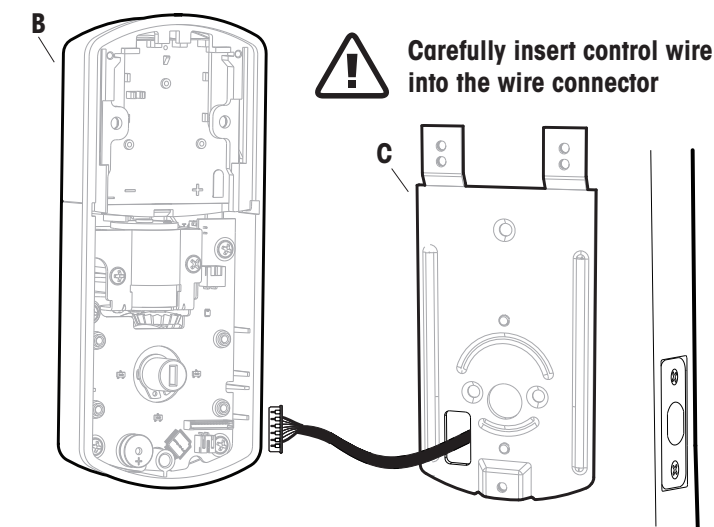

**Work with the door open**

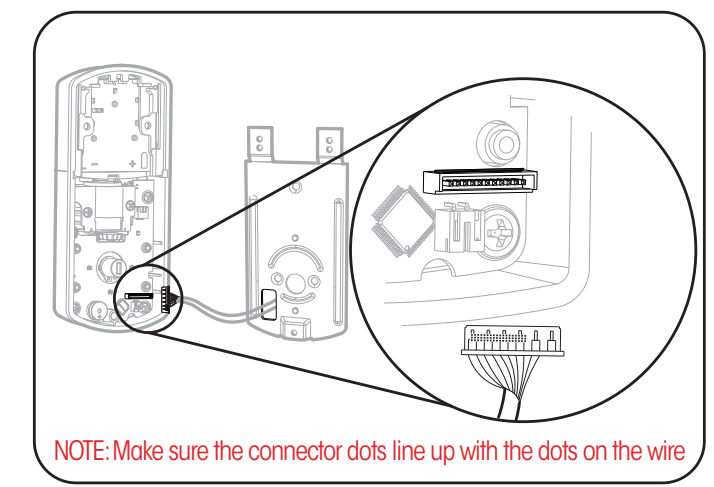

**5 Install Interior Assembly**

NOTE: Make sure the Knob is in the correct position. Be careful not to pinch the control wire when assembling

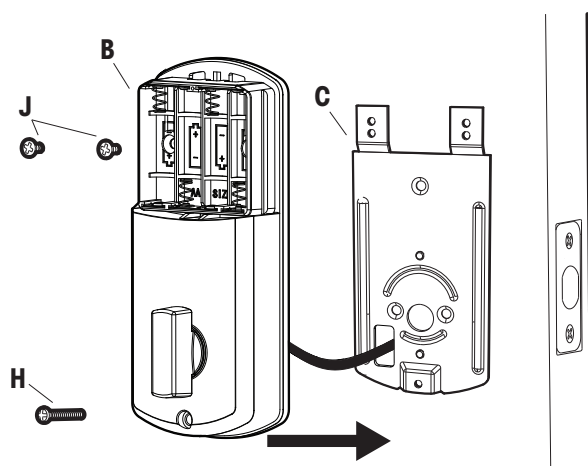

**Test the lock**

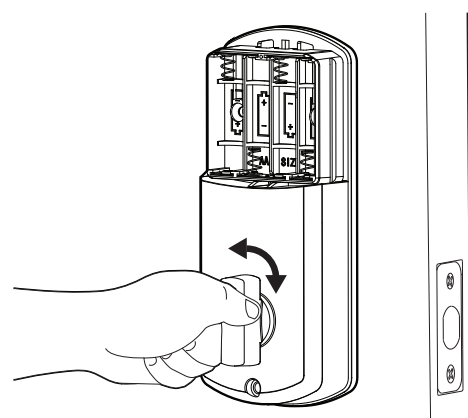

Lock and unlock using the knob make sure the latch is opening and closing easily. If not, go back to step 2 and ensure you followed the steps

**6 Install Batteries and Cover**

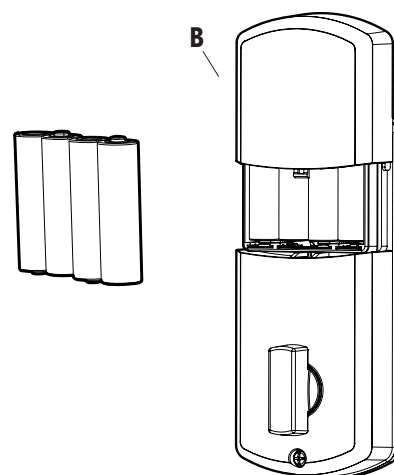

This Electronic lock requires (4) High Quality AA Alkaline batteries. When all 4 batteries are installed in the correct position, you should hear 2 beeps and the keypad will illuminate.

The Lock motor will engage and do a series of locking and unlocking motions in order to automatically determine your door "Handing" (left or right handed door). When completed the lock will beep and the keypad will flash.

**NOTE: Do not touch the Keypad until the light turns off. Do not use rechargeable batteries or non-alkaline batteries.**

**Before Opening Door Let Motor Complete Cycle**

**7 Testing Operation**

Test the lock button with door open

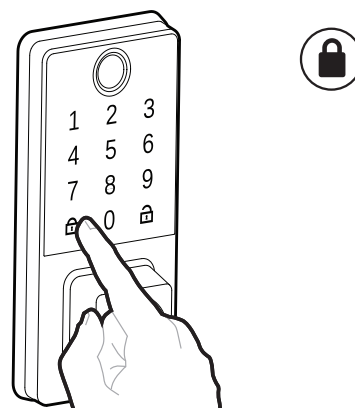

Test unlocking Press 1-2-3-4

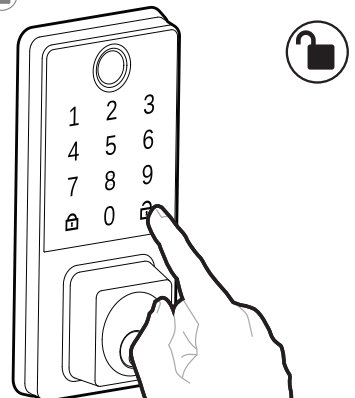

**Before Opening Door Let Motor Complete Cycle**

**Preparing Door**

**Tools Needed for Door Preparation (if there is no knob hole):**

NOTE: Skip this step if your door comes with pre-drilled holes.

- Drill
- 2 1/8" Hole Saw
- 1" Hole Saw
- 3/4" Chisel

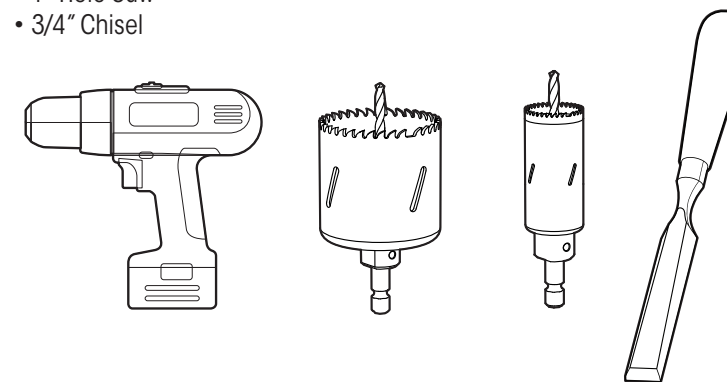

**Refer to Template included for Door Prep Instructions**

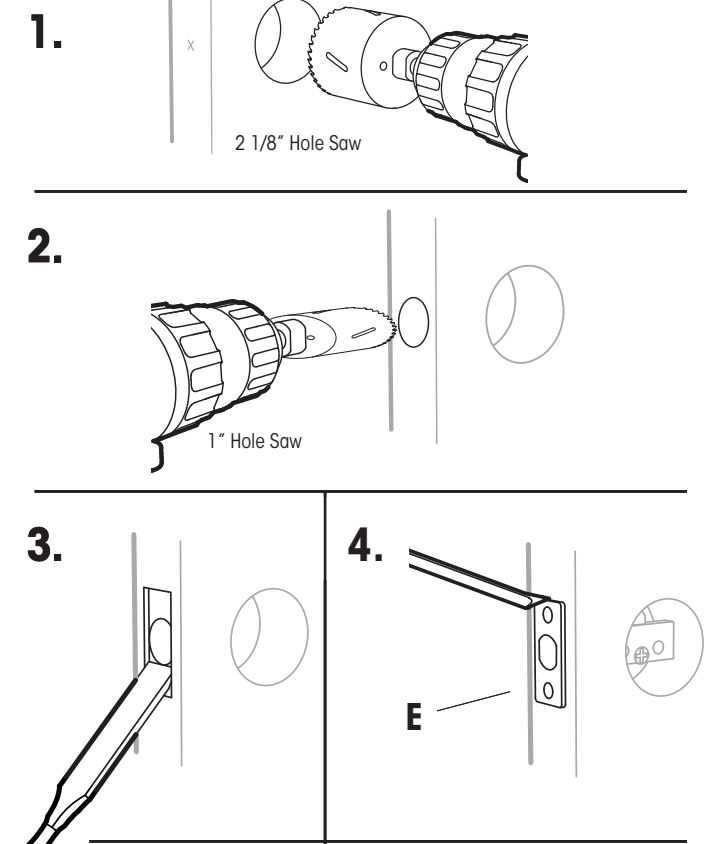
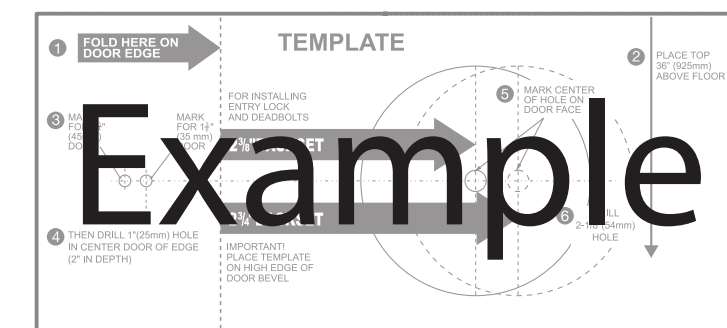

**Strike Plate Installation**

NOTE: The strike plate on the door frame needs to be straight and not protruding from door frame. Make adjustment before installing or this will cause problems with bolt fitting into latch hole.

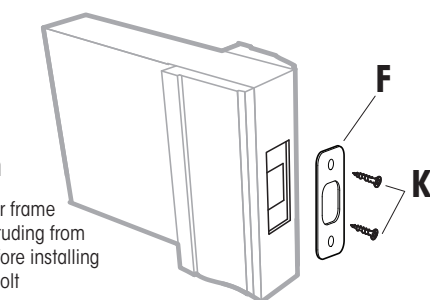

## Programming Instructions



Download the My Key Mobile App from the APP store or Google Play

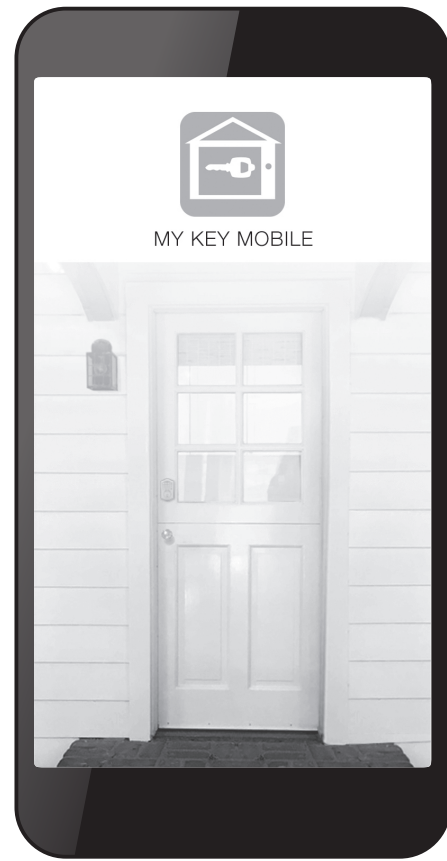

### 1 Register an Account

1. Press "Register" on the login screen
2. Enter your phone number and preferred password



3. Press "Get Code" and enter the verification code received via text msg in the required field
4. Success! Use the selected phone # and password to log into your My Key Mobile App



### 2 Add a Lock



Press Any Key on the Keypad to Wake up Lock. The Keypad Must be Lit in order to add the Lock

1. Select Door Lock
2. Activate the Keypad
3. Press the "+" next to the lock you wish to add

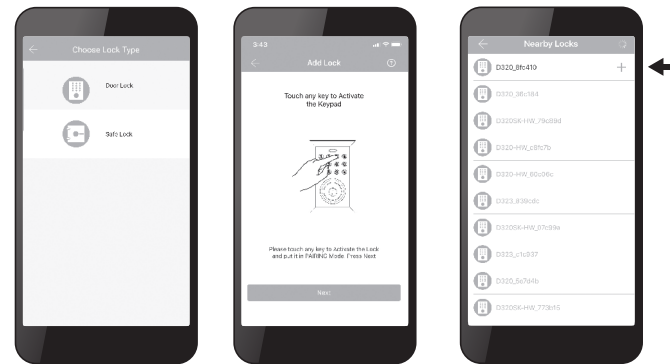

4. Success! Name your Locks
4. Configure Network

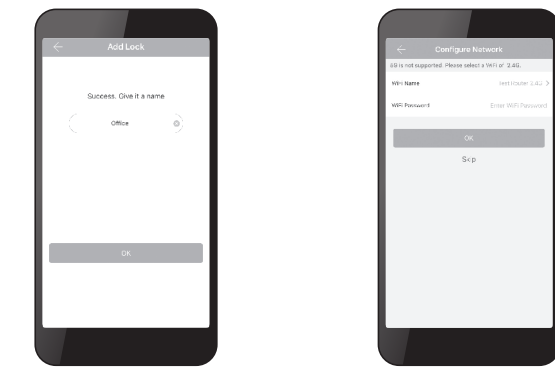

### 3 Change Admin Passcode

Passcode can be used to unlock from keypad

1. Press the settings "⚙️" in the top right of the lock screen
2. Select Basics from the setting list

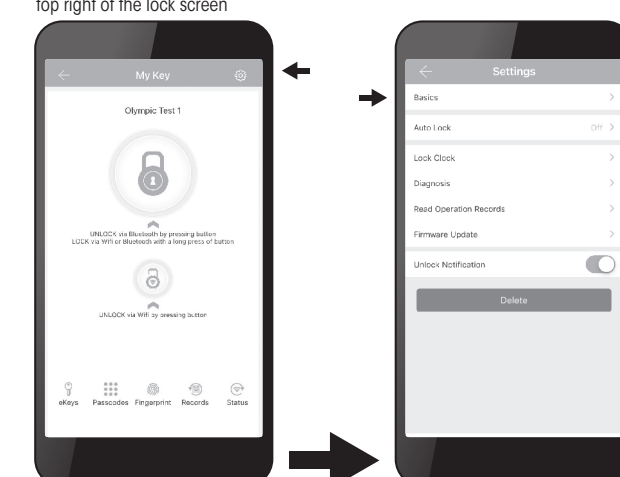

3. Select "Admin Passcode"
4. Set your new 6-digit Admin Passcode

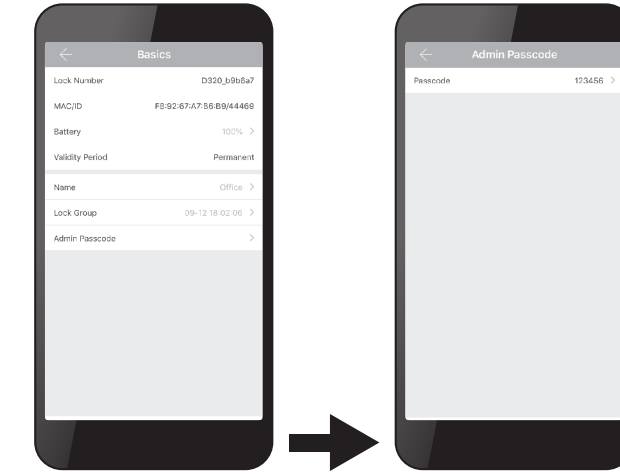

### 4 Locking and Unlocking via APP

Tap the Lock Icon to unlock door

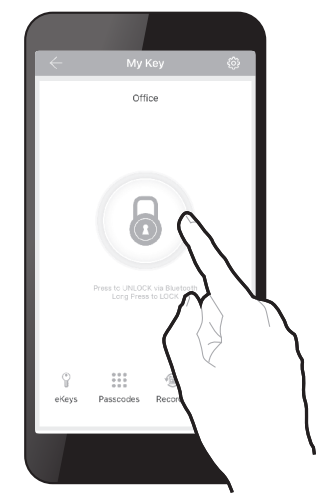

Hold the Lock Icon to lock door

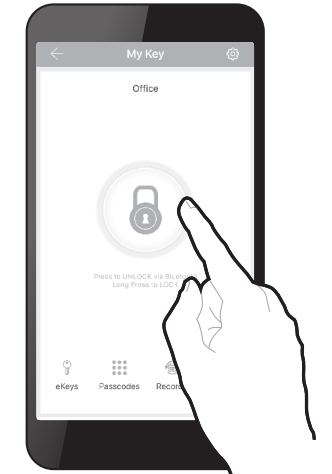

### 5 Creating and Sending eKeys

1. On the Lock Screen select the eKey Icon
2. Select SEND eKEYS



3. Select Validity Period (Timed, Permanent, etc.)
3. Enter the recipients Phone # and Name. Hit send to confirm

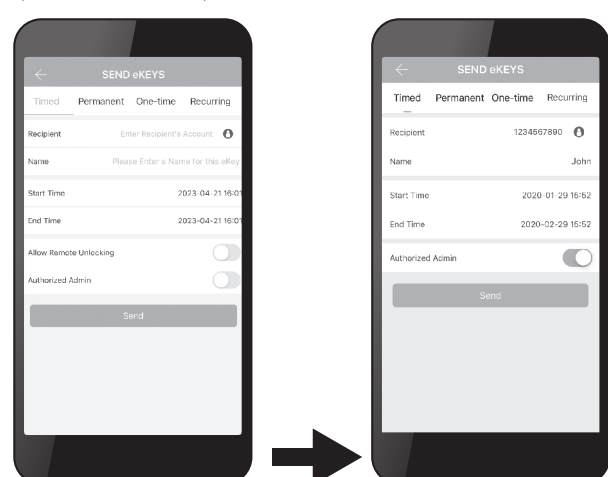

### 6 Creating Custom Passcodes

1. On the Lock Screen select the Passcode Icon
2. Select GENERATE PASSCODES



3. Select "Custom" and select the duration or toggle permanent. Press Set Passcode
4. Enter the desired 4-9 digit passcode



### 7 Additional Programming Functions

You can also use the APP to make these changes in settings

#### TURN ON/OFF AUTO LOCK FUNCTION

- Input the Admin Passcode
- Green light and beep
- 5
- Green light and beep
- Input time (20 - 900 seconds, and 00 to turn off)
- Green light and beep

#### VACATION MODE

- Input the Admin Passcode
- Green light and beep
- 10
- Green light and beep
- 1
- Green light and beep

#### SOUND OFF

- Input the Admin Passcode
- Green light and beep
- 6
- Green light and beep
- 1
- Green light and beep

#### SOUND ON

- Input the Admin Passcode
- Green light and no beep
- 6
- Green light and no beep
- 2
- Green light and no beep

#### Restore Factory Settings

- Press the reset button on the PCB board until you hear one beep. Release, and then three seconds later you will hear a second beep after three seconds. This indicates that the lock has been reset to the Factory Settings. (Remove cover, The reset button is located inside the back panel. See image below)

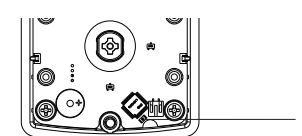

- The Administrator of the lock deletes the lock from the App (Must be done near lock)

## Troubleshooting

Issue	Solution
Lock will not function electronically.	<ul style="list-style-type: none"> <li>Check that all batteries are fresh high quality Alkaline Batteries</li> <li>Check for proper polarity (+ -) of all batteries</li> <li>Check that the Control Wire is attached to the Interior Assembly</li> </ul>
Lock gives error signal when opening or locking and Latch will not extend or retract completely when closed.	<ul style="list-style-type: none"> <li>Unlock door using Key or Interior Knob</li> <li>While door is open, check that the Latch operates smoothly</li> <li>Check for proper alignment of the strike plate, adjust as needed to assure there is no binding against the Latch</li> </ul>
The Latch is sticking.	<ul style="list-style-type: none"> <li>Installation screws of the lock may be too tight and have to be loosened</li> <li>Remove Interior Assembly</li> <li>Slightly loosen the Mounting Plate screws</li> <li>Lock and unlock using the Key</li> <li>Reattach Control Wire and Interior Assembly</li> </ul>
The Keypad is not working.	<ul style="list-style-type: none"> <li>Application may be overriding the Keypad programming</li> <li>Check and see if the App has been connected to the lock</li> <li>Open the App and check the locks' setting to view/change the Administrator Code</li> </ul>
The App is unable to connect to a lock.	<ul style="list-style-type: none"> <li>Bluetooth is off, smart device is not compatible, or the lock may not be activated</li> <li>Contact customer assistance regarding compatibility issues, but iPhone 5 and later models, and most Android devices are compatible</li> <li>Turn Bluetooth on, and ensure the lock is activated by pressing a keypad button on the physical lock until you see the icon to add the lock</li> </ul>
eKeys will not send after.	<ul style="list-style-type: none"> <li>Only registered users of the App can receive eKeys. Ensure that whoever is receiving the eKey has a registered account, and their information is entered correctly</li> <li>Ensure you are connected to WiFi, and that the smart device is updated</li> </ul>
The default Keypad Passcode is not working.	<ul style="list-style-type: none"> <li>If you have connected to the lock with the App, then the default Passcode is invalid, and is replaced with a new Passcode generated by the App, which should be changed</li> </ul>
Forgotten Password.	<ul style="list-style-type: none"> <li>On the home screen select the Forgot Password option, then select the account type that was registered, and follow the prompts to create a new Password</li> </ul>
Latch is not locking in inclement weather.	<ul style="list-style-type: none"> <li>Push or pull door to direct latch</li> <li>Re-adjust Latch for smoother operations</li> </ul>

### Contact Us First! Do Not Return to Store

EMAIL: locks@lewishymaninc.com  
 WEBSITE: www.trubollocks.info  
 ADDRESS: Consumer Assistance Dept.  
 Lewis Hyman, Inc.  
 860 East Sandhill Avenue  
 Carson, CA 90746 USA  
 TELEPHONE: US/Canada 800-860-1677 Ext. 1801 (Toll Free)

Don't forget to register your lock at [Trubollocks.info](http://Trubollocks.info) for updates.

Limited 1-Year Electronic Warranty - Limited Lifetime Mechanical and Finish Warranty  
 This Tru-Bolt® product comes with a 1-Year Limited Warranty on Electronic Parts and a Limited Lifetime Mechanical and Finish Warranty against defects in materials and workmanship under normal use to the original residential user. Proof of purchase and ownership is required for the warranty to be in effect.

This warranty is non transferable and applies to the original purchaser only, as long as the original purchaser occupies the residential premises upon which the product(s) was originally installed. This warranty DOES NOT COVER removal and reinstallation of product(s), scratches, abrasions, deterioration due to the use of paints, solvents or other chemicals, abuse, misuse, or product(s) used in commercial applications, does not cover any losses, injuries to persons/property or costs, and shipping and freight expenses required to return product(s). In no event shall Tru-Bolt® be liable for any special, incidental or consequential damages. If this product(s) is considered a consumer product, please be advised that some local and state laws do not allow limitations on incidental or consequential damages or how long an implied warranty lasts, so that the above limitations may not fully apply. Refer to your local laws for your specific rights under this warranty. If there are any problems please call our customer service with any questions or concerns.

**Package Warranty:**  
 Limited Lifetime Mechanical & Finish Warranty.  
 This Tru-Bolt® product(s) comes with a 1-Year Limited Warranty on Electronic Parts and a Limited Lifetime Mechanical and Finish Warranty against defects in materials and workmanship under normal use to the original residential user. If there are any problems please call our customer service with any questions or concerns. See installation instructions for full terms and conditions.

**DO NOT RETURN TO STORE**  
 For questions / comments, technical assistance or repair parts - please call toll free at: 1-800-860-1677 x 1801 (M-F 7am-5pm PST)

**Regulatory Compliance**  
 This product complies with standards established by following regulatory bodies:  
 - Federal Communications Commission (FCC)

**FCC ID: 2AYCK174XXX863XXX**  
 This device complies with Part 15 of the FCC rules. Operation is subject to the following two conditions:  
 (1) This device may not cause harmful interference, and  
 (2) This device must accept any interference, including interference that may cause undesired operation



**IMPORTANT!** Changes or modifications not expressly approved by the manufacturer could void the user's authority to operate the equipment.

**NOTE:** This equipment has been tested and found to comply with the limits for a Class B digital device, pursuant to Part 15 of the FCC Rules. These limits are designed to provide reasonable protection against harmful interference in a residential installation. This equipment generates uses and can radiate radio frequency energy and, if not installed and used in accordance with the instructions, may cause harmful interference to radio communications. However, there is no guarantee that interference will not occur in a particular installation. If this equipment does cause harmful interference to radio or television reception, which can be determined by turning the equipment off and on, the user is encouraged to try to correct the interference by one or more of the following measures:  
 • Reorient or relocate the receiving antenna.  
 • Increase the separation between the equipment and receiver.  
 • Connect the equipment into an outlet on a circuit different from that to which the receiver is connected.  
 • Consult the dealer or an experienced radio/TV technician for help.

This equipment complies with FCC radiation exposure limits set forth for an uncontrolled environment. This equipment should be installed and operated with a minimum distance of 20cm between the radiator & your body. This transmitter must not be co-located or operating in conjunction with any other antenna or transmitter.