

SYLVANIA

MODEL NO. SKCR2613B

UNDERCABINET MUSIC SYSTEM with BLUETOOTH INSTRUCTION MANUAL

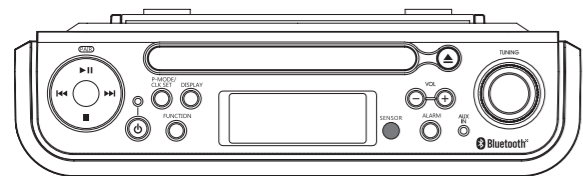

PLEASE READ BEFORE OPERATING THIS EQUIPMENT

SYLVANIA is a registered trademark of OSRAM SYLVANIS Inc. used under licence.

Warnings and Precautions

TO PREVENT FIRE OR SHOCK HAZARDS, DO NOT EXPOSE THIS UNIT TO RAIN OR MOISTURE.



This symbol, located on back or bottom of the unit, is intended to alert the user to the presence of uninsulated "dangerous voltage" within the product's enclosure that may be of sufficient magnitude to constitute a risk of electric shock to persons.



This symbol, located on back or bottom of the unit, is intended to alert the user to the presence of important operating and maintenance (servicing) instructions in the literature accompanying the appliance.



This product utilizes a Class 1 laser to read Compact Discs. This Laser Compact Disc Player is equipped with safety switches to avoid exposure when the CD door is open and the safety interlocks are defeated. Invisible laser radiation is present when the CD Player's lid is open and the system's interlock has failed or been defeated. It is very important that you avoid direct exposure to the laser beam at all times. Please do not attempt to defeat or bypass the safety switches.

CAUTION: TO PREVENT ELECTRIC SHOCK, MATCH WIDE BLADE OF PLUG TO WIDE SLOT, FULLY INSERT.

To reduce the risk of electric shock, do not remove cover (or back). There are no user-serviceable parts inside. Please refer any servicing to qualified service personnel.

WARNING: Changes or modifications to this unit not expressly approved by the party responsible for compliance could void the user's authority to operate the equipment.

Do not mix old and new batteries. Do not mix alkaline, standard (carbon-zinc), or rechargeable (ni-cad, ni-mh, etc) batteries.

NOTE: This equipment has been tested and found to comply with the limits for a Class B digital device, pursuant to Part 15 of the FCC Rules. These limits are designed to provide reasonable protection against harmful interference in a residential installation. This equipment generates, uses, and can radiate radio frequency energy and, if not installed and used in accordance with the instructions, may cause harmful interference to radio communications. However, there is no guarantee that interference will not occur in a particular installation. If this equipment does cause harmful interference to radio or television reception, which can be determined by turning the equipment off and on, the user is encouraged to try to correct the interference by one or more of the following measures:

- Reorient or relocate the receiving antenna.
- Increase the separation between the equipment and receiver.
- Connect the equipment into an outlet on a circuit different from that to which the receiver is connected.
- Consult the dealer or an experienced radio/TV technician for help.

FCC ID: 2AYB7696MET22BT

Important Safety Instructions

- Read Instructions** - All the safety and operating instruction should be read before the product is operated.
 - Retain Instructions** - The safety and operating instruction should be retained for future reference.
 - Heed Warnings** - All warning on the product and in the operating instructions should be adhered to.
 - Follow instructions** - All operating and use instructions should be followed.
 - Cleaning** - Unplug this product from the wall outlet before cleaning. Do not use liquid cleaners or aerosol cleaners. Clean only with a dry cloth.
 - Attachments** - Do not use attachments not recommended by the product manufacturer as they may cause hazards.
 - Water and Moisture** - Do not use this product near water - for example, near a bath tub, wash bowl, kitchen sink, or laundry tub; in a wet basement, or near a swimming pool, and the like. The apparatus shall not be exposed to dripping or splashing and that no objects filled with liquids, such as vases, shall be placed on apparatus.
 - Accessories** - Do not place this product on an unstable cart, stand, tripod, bracket, or table. The product may fall, causing serious injury to a child or adult, and serious damage to the product. Use only with a cart, stand, tripod, bracket, or table recommended by the manufacturer, or sold with the product. Any mounting of the product should follow the manufacturer's instructions, and should use a mounting accessory recommended by the manufacturer.
 - A product and cart combination should be moved with care. Quick stops, excessive force, and uneven surfaces may cause the appliance and cart combination to overturn.
- See figure:*
-
- Ventilation** - Slots and openings in the cabinet are provided for ventilation and to ensure reliable operation of the product and to protect it from overheating, and these openings must not be blocked or covered. The openings should never be blocked by placing the product on a bed, sofa, rug, or other similar surface. This product should not be placed in a built-in installation such as a bookcase or rack unless proper ventilation is provided or the manufacturer's instructions have been adhered to.
 - Power Sources** - This product should be operated only from the type of power source indicated on the marking label. If you are not sure of the type of power supply to your home, consult your product dealer or local power company. For products intended to operate from battery power, or other sources, refer to the operating instruction.
 - Grounding or Polarization** - This product may be equipped with a polarized alternating-current line plug (a plug having one blade wider than the other). This plug will fit into the power outlet only one way. This is a safety feature. If you are unable to insert the plug fully into the outlet, try reversing the plug. If the plug should still fail to fit, contact your electrician to replace your obsolete outlet. Do not defeat the safety purpose of the polarized plug.
 - Alternate Warnings** - This product is equipped with a three-wire grounding-type plug, a plug having a third (grounding) pin. This plug will only fit into a grounding-type power outlet. This is a safety feature. If you are unable to insert the plug into the outlet, contact your electrician to replace your obsolete outlet. Do not defeat the safety purpose of the grounding-type plug.
 - Power-Cord Protection** - Power supply cords should be routed so that they are not likely to be walked on or pinched by items placed upon or against them, paying particular attention to cords at plugs, convenience receptacles, and point where they exit from the product.
 - Protective Attachment Plug** - The product is equipped with an attachment plug having overload protection. This is a safety feature. See Instruction Manual for replacement or reattaching of protective device. If replacement of the plug is required, be sure the service technician has used a replacement plug specified by the manufacturer that has the same overload protection as the original plug.
 - Outdoor Antenna Grounding** - If an outside antenna is connected to the receiver, be sure the antenna system is grounded so as to provide some protection against voltage surges and built-up static charges. Article 810 of the National Electrical Code, ANS/NFPA 70, provides information with regard to proper grounding of the mast and supporting structure, grounding of the lead-in wire to an antenna-discharge unit, size of grounding conductors, location of antenna-discharge unit, connection to grounding electrodes, and requirements for the grounding electrode.
 - See figure:*
 - Lightning** - For added protection for this product during a lightning storm, or when it is left unattended and unused for long periods of time, unplug it from the wall outlet and disconnect the antenna or cable system. This will prevent damage to the product due to lightning and power-line surges.
 - Power Lines** - An outside antenna system should not be located in the vicinity of overhead power lines or other electric light or power circuits, or where it can fall into such power lines or circuits. When installing an outside antenna system, extreme care should be taken to keep from touching such power lines or circuits as contact with them might be fatal.
 - Overloading** - Do not overload wall outlets, extension cords, or integral convenience receptacles as this can result in a risk of fire or electric shock.
 - Object and Liquid Entry** - Never push objects of any kind into this product through openings as they may touch dangerous voltage points or short-out parts that could result in a fire or electric shock. Never spill liquid of any kind on the product.
 - Servicing** - Do not attempt to service this product yourself as opening or removing covers may expose you to dangerous voltage or other hazards. Refer all servicing to qualified service personnel.
 - Damage Requiring Service** - Unplug this product from the wall outlet and refer servicing to qualified service personnel under the following conditions:
 - When the power-supply cord or plug is damaged,
 - If liquid has been spilled, or objects have fallen into the product,
 - If the product has been exposed to rain or water,
 - If the product does not operate normally by following the operating instructions. Adjust only those controls that are covered by the operating instructions as an improper adjustment of other controls may result in damage and will often require extensive work by a qualified technician to restore the product to its normal operation.
 - If the product has been dropped or damaged in any way, and
 - When the product exhibits a distinct change in performance - this indicates a need for service.
 - Replacement Parts** - When replacement parts are required, be sure the service technician has used replacement parts specified by the manufacturer or have the same characteristics as the original part. Unauthorized substitutions may result in fire, electric shock, or other hazards.
 - Safety Check** - Upon completion of any service or repairs to this product, ask the service technician to perform safety checks to determine that the product is in proper operating condition.
 - Wall or Ceiling Mounting** - The product should be mounted to a wall or ceiling only as recommended by the manufacturer.
 - Heat** - The product should be sited away from heat sources such as radiators, heat registers, stoves, or other products (including amplifiers) that produce heat. Battery shall not be exposed to excessive heat such as sunshine, fire, or the like.
 - Main plug is used as disconnect device and it should remain readily operable during intended use. In order to disconnect the apparatus from the mains completely, the mains plug should be disconnected from the mains socket outlet completely.
 - Excessive sound pressure from earphones and headphones can cause hearing loss.

PREPARATION FOR USE

Power Sources

Main Unit:

Connect the small plug from AC/DC Adapter to the DC IN Jack at the back of the main unit then plug the AC/DC Adapter to standard AC wall outlet.

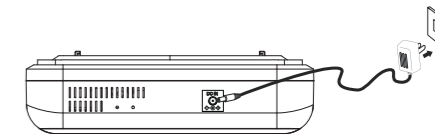

NOTES:

- If the AC power failure, this electronic clock is designed to continue operating internally (without showing the time on the Clock Display) with three (3) AAA size batteries (not included). Install the batteries as follows:

1. Open the battery door on the left side of the unit by sliding it out and then lifting it as the illustrated on right:

2. Insert three (3) AAA size batteries (not included) according to the polarity diagram inside the battery compartment. (Alkaline batteries are recommended.)

3. Replace the battery door.

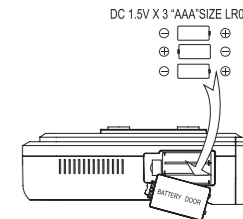

Remote Control:

In first time use, remove and discard the insulation film on the battery compartment as the illustrated follows:

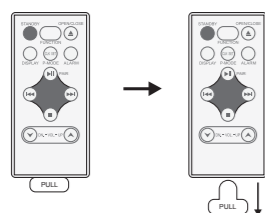

To replace the button cell if it is consume:

1. Push and slide out the battery tray as the illustrated below.
2. Replace the button cell by a new CR2025 button cell with the polarity "+" face up as the illustrated below and the marking on the rear of Remote Control.
3. Close the battery tray.



BATTERY PRECAUTIONS:

Follow these precautions when using a battery in this device:

1. Use only the size and type of battery specified.
2. Be sure to follow the correct polarity when installing the battery as indicated in the battery compartment. A reversed battery may cause damage to the device.
3. Do not mix different types of batteries together (e.g. Alkaline and Carbon-zinc) or old batteries with fresh ones.
4. If the batteries in the device are consumed or the device is not to be used for a long period of time, remove the batteries to prevent damage or injury from possible battery leakage.
5. Do not try to recharge the battery not intended to be recharged; it can overheat and rupture. (Follow battery manufacturer's instructions.)
6. Do not dispose of battery in fire. Battery may explodes or leak.
7. Clean the battery contacts and also those of the device prior to battery installation.
8. This product contains a coin/button cell battery. If the coin/button cell battery is swallowed, it can cause severe internal burn in just 2 hours and can lead to death. Keep new and used batteries away from children. If the battery compartment does not close securely, stop using the product and keep it away from children. If you think batteries might have been swallowed or placed inside any part of the body, seek immediate medical attention.

LOCATION OF CONTROLS

Main Unit:

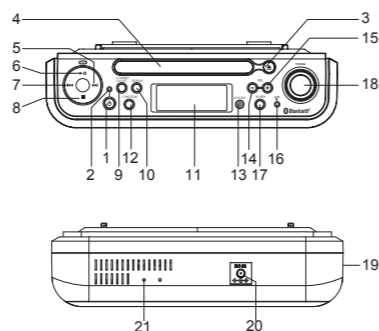

1. STANDBY Button
2. STANDBY Indicator
3. CD Door Open/Close Button
4. CD Door
5. Fast Search Forward/Skip Forward Button
6. PAUSE/PAIR (Play-Pause/BT Pair) Button
7. Fast Search Backward/Skip Backward
8. Stop Button
9. P-MODE/CLK SET (Program-Mode/Clock set) Button
10. DISPLAY Button
11. LCD Display
12. FUNCTION Button
13. (Remote) SENSOR
14. VOL - (Volume down) Button
15. VOL + (Volume up) Button
16. AUX IN Jack
17. ALARM Button
18. TUNING Knob
19. Battery Compartment
20. DC IN Jack
21. FM Antenna

Remote Controls:

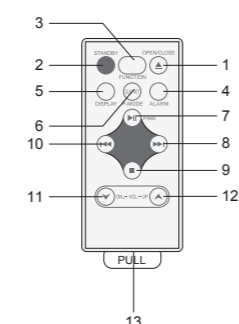

1. CD Door OPEN/CLOSE Button
2. STANDBY Button
3. FUNCTION Button
4. ALARM Button
5. DISPLAY Button
6. CLK SET/P-MODE (Clock set/Program-Mode) Button
7. PAUSE/PAIR (Play-Pause/BT Pair) Button
8. Fast Search Forward/Skip Forward Button
9. Stop Button
10. Fast Search Backward/Skip Backward Button
11. VOL DN (Volume down) Button
12. VOL UP (Volume up) Button
13. Battery Tray

INSTALLATION

Install the unit to the bottom of cabinet (if need) as follows:

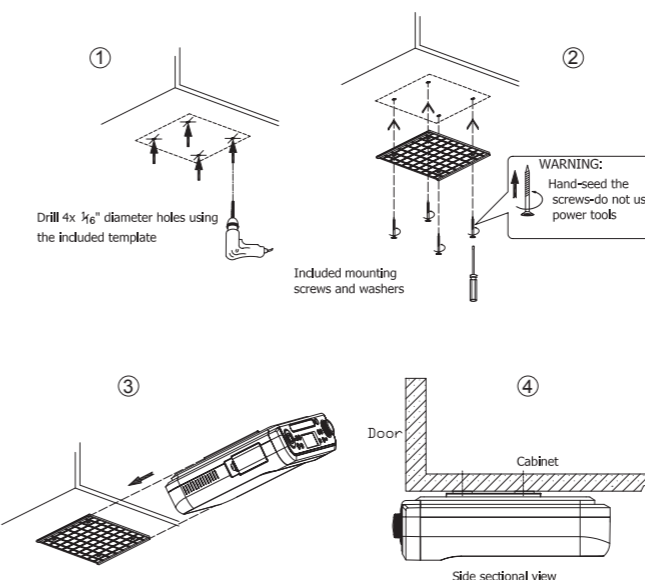

CAUTION: To reduce the risk of fire, never mount the unit near any heat elements such like stoves; oven ... etc.

OPERATION

GENERAL OPERATION:

1. Connected the unit to AC power as instructed earlier. The Red Indicator will illuminate.
2. Press the \odot Button on the unit or Remote Control to power on the unit from standby mode. The Red Indicator will not light and the LCD Display will illuminate.
3. Press the FUNCTION Button on the unit or Remote Control repeatedly to select the playback source.
4. Press the VOL +/- Buttons on the unit or the VOL DN/UP Buttons on the Remote Control to adjust volume level as desire.
5. When finished listening, press the \odot Button on the unit or Remote Control to turn off (standby) the unit. The Red Indicator will illuminate.



ACTUAL TIME SETTINGS:

To set or reset the actual time:

1. In power off (Standby) mode. Press and hold the P-MODE/CLK SET Button on the unit or Remote Control approximate 2 seconds until the digit of Hour on the LCD Display is blinking.
2. Press the \lll or \ggg Button on the unit or Remote Control repeatedly to set hour. (Make sure the PM Indicator appear on the display if the time is PM and the AM Indicator is appear on the display if the time is AM).
3. Press the P-MODE/CLK SET Button again, the digit of Minute will blink.
4. Press the \lll or \ggg Button repeatedly to set minute.
5. When finished, press the P-MODE/CLK SET Button to save the settings and exit. The display will stop blinking.

BT (BLUETOOTH)





In first time use or re-pairing to a new BT Device, pairing it as below:

1. In standby mode, press the  Button to power on the unit.
2. Press the FUNCTION Button repeatedly until the indicator  appear on the display and blink.
3. Power on the external BT Device and enter to BT searching mode. Start pairing as the on screen instructions on the external BT Device. After paired, the indicator  will stop blinking. (For details pairing procedures, please refer to the user's manual of your BT Device.).
4. Plays the music in the paired BT Device as usual.



Notes:

- When the external BT Device searched the unit, our model number "SYLVANIA SKCR2613B" will appear on the display of external BT Device.
- Pairing code "0000" or "1234" may need to enter.



Normal operation after paired:

1. Turn on the BT function of the external BT Device.
2. Power on the unit and enter to BT mode as the instructed earlier. The indicator  will appear on the display and blink.
3. Wait a few seconds until the unit auto paired to the external BT Device. (The indicator  will stop blinking).
4. Plays the music in the paired BT Device as usual.
5. During playback:
 - Press the PAIR/  Button to pause; press again to resume normal playback.
 - Press the  /HR or  /MIN Button to skip tracks.

Note:

If the unit already paired to an external BT Device and you wants to pair the unit to another new external BT Device in BT paired mode. Press and hold the PAIR/  Button on the unit or Remote Control approximate 2 seconds until the indicator  on the display start blinking to unpaired it. And then pair the new BT Device to the unit as the instructed earlier.

CD:

1. In standby mode, press the  Button to power on the unit.
2. Press the FUNCTION Button repeatedly until "--" or "no" (No Disc) appear on the display.
3. Press the  Button to open the CD door then place a CD disc on the tray, with the printed label side up.

8

CARE AND MAINTENANCE

Caring for Compact Discs

Treat the disc carefully. Handle the disc only by its edges. Never allow your fingers to come in contact with the shiny, unprinted side of the disc.

Do not attach adhesive tape, stickers, etc.

To the compact disc label.

Clean the compact disc periodically with a soft, lint-free, dry cloth. Never use detergents or abrasive cleaners to clean the disc. If necessary, use a CD cleaning kit. If a disc skips or gets stuck on a section of the disc, it is probably dirty or damaged (scratched). When cleaning the disc, wipe in straight lines from the center of the compact disc to the outer edge of the disc. Never wipe in circular motions.

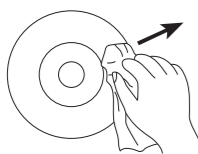

This unit is designed to play only compact discs bearing the identification logo as shown here. Other discs may not conform to the CD standard and may not play properly. Compact Discs should be stored in their cases after each use to avoid damage.



Do not expose compact discs to direct sunlight, high humidity, high temperatures or dust, etc. Prolonged exposure or extreme temperatures can warp the compact disc.









Do not stick or write anything on either side of the compact disc, Sharp writing instruments, or the ink, may damage the surface.

Cleaning the Unit

To prevent fire or shock hazard, disconnect your unit from the AC power source when cleaning.

The finish on your unit may be cleaned with a dust cloth and cared for as other furniture. Use caution when cleaning and wiping the plastic parts. Mild soap and a damp cloth may be used on the front panel.

12





4. Close the CD door by press the  Button; the unit will start playback automatically.
5. During playback:
 - A. Press the PAIR/  Button to pause; press again to resume normal playback.
 - B. Press the  or  Buttons repeatedly to skip tracks.
 - C. Press and hold the  or  Buttons to fast searching the specific section then release the button to resume normal playback.
 - D. Press the DISPLAY Button to read the actual time.
6. To stop CD playback, press the  Button. The total number of tracks will appear on the display.
7. When finished listening, press the  Button to power off (standby mode) the unit.

Repeat Playback:

1. During playback, press the P-MODE/CLK SET Button once. The repeat indicator "REPEAT 1" will appear on the display. The current track will playback repeatedly.
2. During playback, press the P-MODE/CLK SET Button twice. The repeat all indicator "REPEAT ALL" will appear on the display. All the tracks on the current disc (or program) will be playback repeatedly.
3. To cancel the repeat function, press the P-MODE/CLK SET Button repeatedly until all the repeat indicators disappear on the display.

Programmed Playback:

Up to 20 tracks can be programmed playback as follows:

1. In CD STOP playback mode, press and hold the P-MODE/CLK SET Button until "PROG 00" appear on the display.
2. Select the first specific track to be programmed by press the  or  Buttons.
3. Press the P-MODE/CLK SET Button again to store the selected track into the memory.
4. Repeat steps 2 and 3 until all the specific tracks were stored into the memory.
5. Press the PAIR/  Button to start playback.
6. To stop playback, press the  Button.
7. To cancel the program, press the  Button again in stop mode. Indicator "PROG" will disappear on the display.

9

TROUBLE SHOOTING GUIDE

Symptom	Possible Cause	Solution
Power		
No power	AC/DC Adatper had not inserted to AC wall outlet.	Plug the Adapter to wall outlet having AC 120V~, 60 Hz.
Radio		
Noise or sound distorted on radio broadcasts	Station not tuned properly.	Retune the radio station.
	The location not good for radio reception.	Unwind the FM Antenna Wire on the rear of to full length and/or relocation it.
		Reassembly the unit to another location for better Radio reception.
No sound	Volume at minimum.	Increase Volume level by press the VOL + (VOL UP) Button.
BT		
BT not functioning	The BT Device had not paired to the unit.	Paired the BT Device to the unit as page 8
Sound distortion	The BT Device too far from the unit.	Place the BT Device close to the unit.
CD		
CD not play	Unit not set to CD mode.	In power on mode, press the FUNCTION Button repeatedly until "--" or "no" (No Disc) appear on the display to enter to CD playback mode.
	CD is installed incorrectly.	Place the CD disc on the CD tray, with the printed label side up.
Distortion or Intermittent sound	Dirty or defective disc.	Try others CD disc.

13

RADIO:

FM Band:

1. In standby mode, press the  Button to power on the unit.
 2. Press the FUNCTION Button repeatedly until "FM XX.X MHz" appear on the display.
 3. Turn the TUNING Knob to receive the desired FM station.
 4. To read the actual time during listening, press the DISPLAY Button once.
- Note: If the receiving FM station is stereo, the unit will auto plays it in stereo mode.

AM Band:

1. In standby mode, press the  Button to power on the unit.
2. Press the FUNCTION Button repeatedly until "AM XXX kHz" appear on the display.
3. Turn the TUNING Knob to receive the desired AM station.
4. To read the actual time during listening, press the DISPLAY Button once.

Antennas:

AM:

This unit has a build in ferrite rod antenna, which provides adequate reception in most areas. If reception is weak, reassemble the unit to other location to improve reception.

FM:

The FM Antenna Wire on the rear of unit is for FM reception only. If reception is weak, unwind it to full length and/or relocation.

AUX IN

Listen music from the external Audio Player as follows:

1. Connected the external Audio Player by an audio connection cable with 3.5mm stereo plugs (Cable not included).
2. Insert one end to the AUX IN Jack on the front of unit.
3. Insert the other end to the Phones Jack; Line Out Jack or AUX Out Jack on the external Audio Player.
4. Press the  Button to power on the unit from standby mode.
5. Press the FUNCTION Button repeatedly until indicator "AUX" appear on the display.
6. Plays the music on the connected external Audio Player as usual.

Note: Make sure the volume level of the external Audio Player was set to high. Otherwise, sound from this unit may weak.

10

GENERAL SPECIFICATIONS:

DC IN Power:	DC 12V , 1.5A
Clock back up:	DC --- 4.5V, 3 x AAA size batteries; Not included
Audio Power:	1.2 W (RMS) x 2
Impedence of Speakers:	8 Ohm; 2W
Radio Band Coverage:	AM 530-1710 KHz FM 88-108 MHz
BT Version:	2.1
BT Effective Range:	32 feet in open area







SPECIFICATIONS AND ACCESSORY ARE SUBJECT TO CHANGE WITHOUT NOTICE

For service assistance and product information, please call: 1-800-968-9853. Pour obtenir assistance et information appelez: 1-800-968-9853.

Curtis International Ltd.
7045 BECKETT DRIVE, UNIT 15,
MISSISSAUGA, ON, L5S 2A3
www.curtisint.com

14

ALARM SET:

1. In power off (Standby) mode. Press and hold the ALARM Button on the unit or Remote Control approximate 2 seconds until indicator "TIMER" and alarm time appear on the display and the digit of hour of it is blinking.
2. Press the  or  Button on the unit or Remote Control repeatedly to set the Hour of alarm. (Make sure the PM Indicator appear on the display if the alarm time is PM and the AM Indicator is appear on the display if the alarm time is AM).
3. Press the ALARM Button again, the digit of Minute will blink.
4. Press the  or  Buttons repeatedly to set minute.
5. Press the ALARM Button again, "Cd" will appear on the display. Press the  or  Buttons repeatedly to select the weak up mode as desire as below:

- Cd= CD Mode
- FM rd= FM Radio
- AM rd= AM Radio
- bu= Buzzer

7. When finished setting, press ALARM Button again to save the settings and exit. The actual time will appear on the display and the indicator "TIMER" will stop blinking.

Important:

- If radio AM/FM was selected as the weak up mode, received the desired radio station before activate alarm. Otherwise, when Alarm goes off, no sound output from the speaker or sound weak.
- If CD was selected as weak up mode, make sure you were place the CD disc into the CD disc tray before activate alarm. Otherwise, when Alarm goes off, no sound output from the speaker.
- In power on mode, alarm will not functioning.

Shut off alarm:

- When alarm goes off, press the ALARM Button to turn off alarm, the alarm will be reset for next day. (The indicator "TIMER" will keep in display).
- To turn off the alarm completely (not reset for next day). Press the ALARM Button repeatedly until the indicator "TIMER" disappear on the display.

11

To make a warranty claim, please email support@curtiscs.com or call 1-800-968-9853.

90 day Warranty

This product is warranted to be free from defects in material and workmanship for a period of ninety (90) days from the date of original purchase. During this period, your exclusive remedy is repair or replacement of this product or component found to be defective, at our option; however, you are responsible for all costs associated with returning the product to us. If the product or component is no longer available, we will replace with a similar one of equal or greater value. Prior to a replacement being sent, the product must be rendered inoperable or returned to us.

This warranty does **not** cover glass, filters, wear from normal use, use not in conformity with the printed directions., or damage to the product resulting from accident, alteration, abuse, or misuse. This warranty extends only to the original consumer purchaser or gift recipient. Keep the original sales receipt, as proof of purchase is required to make a warranty claim. This warranty is void if the product is used for other than single-family household use or subjected to any voltage and waveform other than as on the specified rating on the label (e.g., 120V~60Hz).

We exclude all claims for special, incidental, and consequential damages caused by breach of express or implied warranty. All liability is limited to the amount of the purchase price. **Every implied warranty, including any statutory warranty or condition of merchantability or fitness for a particular purpose, is disclaimed except to the extent prohibited by law, in which case such warranty or condition is limited to the duration of this written warranty.** This warranty gives you specific legal rights. You may have other legal rights that vary depending on where you live. Some states or provinces do not allow limitations on implied warranties or special, incidental, or consequential damages, so the foregoing limitations may not apply to you.

For faster service, locate the model, type, and serial numbers on your appliance.

ATTACH YOUR PROOF OF PURCHASE HERE, PROOF OF PURCHASE IS REQUIRED TO OBTAIN WARRANTY SERVICE.

Please have the following information available when you contact the Support Team:

- Name, address and telephone number.
- Model number and serial number.
- A clear, detailed description of the problem.
- Proof of purchase including dealer or retailer name, address and date of purchase.

15