

MODEL NO. : MET1505

Home Theater Projector Protective Carry Case and Build In Speakers

INSTRUCTION MANUAL

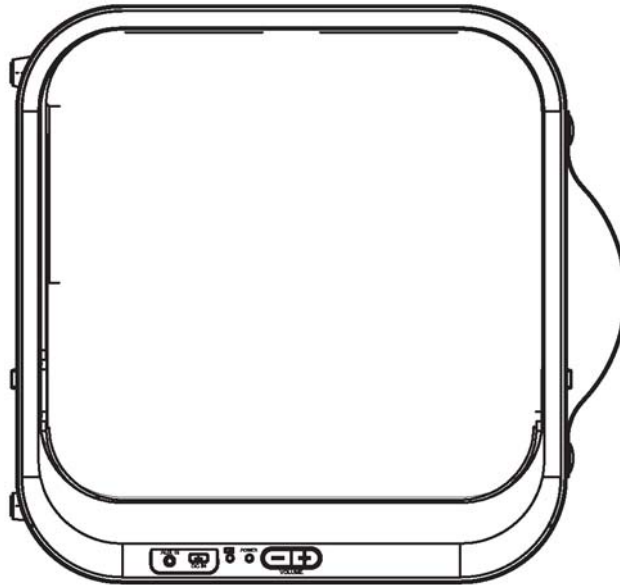

PLEASE READ BEFORE OPERATING THIS EQUIPMENT

Important Safety Instructions

1. Read these Instructions.
2. Keep these Instructions.
3. Heed all Warnings.
4. Follow all instructions.
5. Do not use this apparatus near water.
6. Clean only with a dry cloth.
7. Do not block any ventilation openings. Install in accordance with the manufacturer's instructions.
8. Do not install near any heat sources such as radiators, heat registers, stoves, or other apparatus (including amplifier) that product heat.
9. Protect the power cord from being walked on or pinched particularly at plugs, convenience receptacles, and the point where they exit from the apparatus.
10. Only use attachments/accessories specified by the manufacturer.
11. Unplug this apparatus during lightning storms or when unused for long periods of time.
12. Refer all servicing to qualified service personnel. Servicing is required when the apparatus has been damaged in any way, such as power-supply cord or plug is damaged, liquid has been spilled or objects have fallen into the apparatus, the apparatus has been exposed to rain or moisture, does not operate normally, or has been dropped.
13. Use only with a cart, stand, tripod, bracket, or table specified by the manufacturer or sold with the apparatus. When a cart is used, use caution when moving the cart/ apparatus combination to avoid injury from tip-over.



Additional Warnings and Precautions

1. Do not look directly into the projector light.
2. **Don't touch the project lens**
3. Mains adapter is used as disconnect device and it should remain readily operable during intended use. In order to disconnect the apparatus from the mains completely, the mains plug should be disconnected from the mains socket outlet completely.
4. **CAUTION:** Use of controls or adjustments or performance of procedures other than those specified may result in hazardous radiation exposure.
5. **WARNING:** Changes or modified to this unit not expressly approved by the party responsible for compliance could void the user's authority to operate the equipment.
6. **WARNING:** Use of this unit near fluorescent lighting may cause interference regarding use of the remote. If the unit is displaying erratic behavior move away from any fluorescent lighting, as it may be the cause.
7. **WARNING:** Shock hazard - Do Not Open.
8. Caution and marking information is located at the rear or bottom of the apparatus.
9. **WARNING:** To reduce the risk of fire or electric shock, do not expose this apparatus to rain, moisture, dripping, or splashing.
10. Objects filled with liquids, such as vases, shall not be placed on the apparatus.

FCC Warning

This device complies with Part 15 of the FCC rules. Operation is subject to the following two conditions: (1) this device may not cause harmful interference, and (2) this device must accept any interference received, including interference that may cause undesired operation.

NOTE: This equipment has been tested and found to comply with the limits for a Class B digital device, pursuant to Part 15 of the FCC Rules. These limits are designed to provide reasonable protection against harmful interference in a residential installation. This equipment generates, uses, and can radiate radio frequency energy and, if not installed and used in accordance with the instructions, may cause harmful interference to radio communications. However, there is no guarantee that interference will not occur in a particular installation. If this equipment does cause harmful interference to radio or television reception, which can be determined by turning the equipment off and on, the user is encouraged to try to correct the interference by one or more of the following measures:

- Reorient or relocate the receiving antenna.
- Increase the separation between the equipment and receiver.
- Connect the equipment into an outlet on a circuit different from that to which the receiver is connected.
- Consult the dealer or an experienced radio/TV technician for help.

The equipment complies with FCC radiation exposure limits set forth for an uncontrolled environment. The equipment should be installed and operated with minimum distance 20cm between the radiator & your body.

In The Box

Carrying Case

Main Unit

Lens Cover

Remote

AC Power Adapter

AV Cable

USB (Type C) cable

User Manual

Table of Contents

Important Safety Instructions - - - - -	P1
Additional Warnings and Precautions - - - - -	P2
FCC Warning - - - - -	P3
In The Box - - - - -	P3
Table of Contents - - - - -	P4
Remove & Close the Lens Cover - - - - -	P5
Placing of Your Projector - - - - -	P5
To Reduce Image Distortion - - - - -	P6
Distance Between The Projector And Screen - - - - -	P6
Installing your Projector in the Ceiling - - - - -	P6
Adjust The Vertical Location - - - - -	P7
Adjust The Focus And Keystone - - - - -	P7
Controls of Remote - - - - -	P8
Install / Remove Batteries of Remote - - - - -	P8
Controls of Carrying Case - - - - -	P9
Controls of Projector - - - - -	P10
Install Power Adapter - - - - -	P11
Main Button Operation - - - - -	P11
Connect HDMI show the Image On Projector Screen - - - - -	P12
Connect AV Show The Image On Projector Screen - - - - -	P12
Connect VGA Show The Image On Projector Screen - - - - -	P13
Connect Audio Output (Aux Out / Line Out / Earphones) - - - - -	P14
Install USB Device And Micro SD Card “TF” - - - - -	P14
Using TF Card and USB Playback (Media Player)- - - - - -	P15
Using Bluetooth Playback - - - - -	P16
Carrying Case for AUX IN Operation - - - - -	P16
Charging Carrying Case Battery - - - - -	P16
Rechargeable Battery Operation - - - - -	P16
Using Projector Menu 1 - - - - -	P17
Using Projector Menu 2 - - - - -	P18
Using Projector Menu 3 - - - - -	P18
Specifications - - - - -	P19

Remove & Close The Lens Cover

Remove the lens cover before using

Close the lens cover when unit is not using

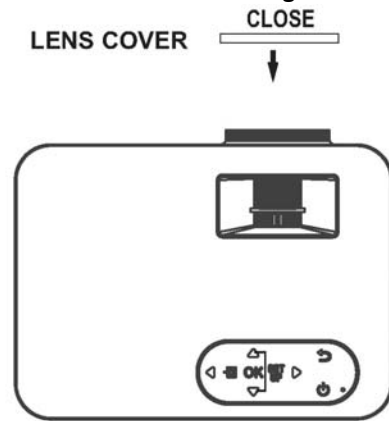

Placing of Your Projector

Your projector can be installed in four different configurations (see picture below):

Front Table

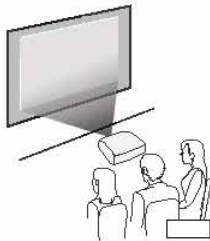

Front Table:

Select this location with the projector placed near the floor in front of the screen. This is the most common way to position the projector for quick setup and portability.

Rear Table

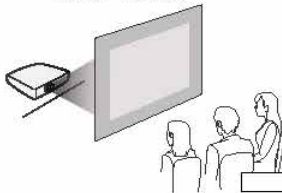

Rear Table:

Select this location with the projector placed near the floor behind the screen.

NOTE: That a special rear projection screen is required.

Front Ceiling

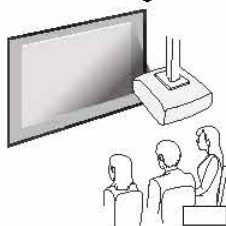

Front Ceiling:

Select this location with the projector suspended upside-down from the ceiling in front of the screen.

NOTE: A projector mount is required to install the projector in a ceiling.

Rear Ceiling

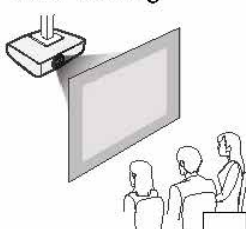

Rear Ceiling:

Select this location with the projector suspended upside-down from the ceiling behind the screen.

NOTE:

A projector mount is required to install the projector in a ceiling. A special rear projection screen is required.

To reduce Image Distortion

- Move the projector as close to the center of the screen as possible.
- The light beam from the projector should be perpendicular to the screen for a rectangular or square image.

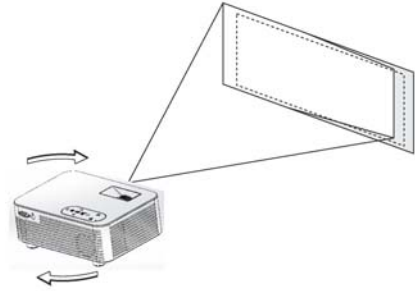

Distance Between The Projector And Screen

Measure the distance between the projector and where you want to position the screen. This is the projection distance.

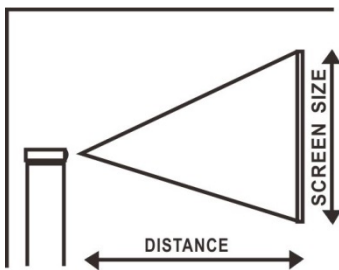

Distance	Screen Size
1.16m	36 inch
1.35m	45 inch
1.51m	50 inch
1.79m	60 inch
2.15m	72 inch
2.81m	100 inch
3.43m	120 inch
4.44m	150 inch

Installing your Projector in the Ceiling

When installing the projector in the ceiling, please purchase a projector mount recommended by an installation professional and follow the instructions that come with the mount.

Before installing the projector in the ceiling, please check to make sure the ceiling structure can support the weight of the projector and the mount. If in doubt, please ask the advice from an installation professional.

NOTE: Projector mount and screw(s) not included

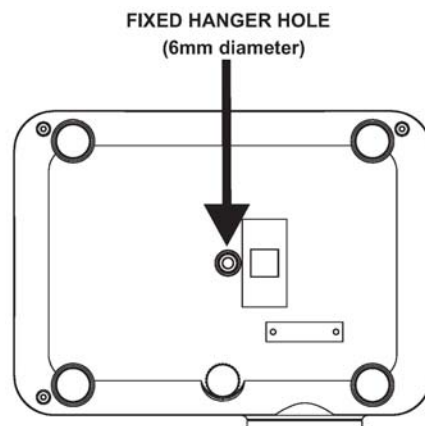
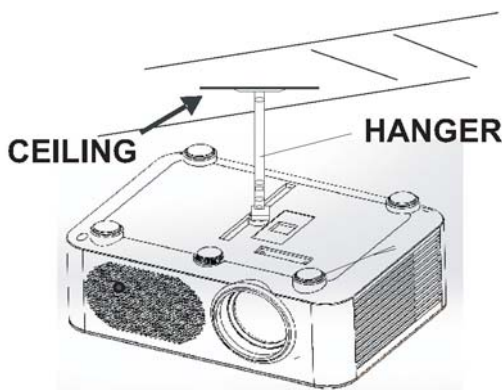

Adjust The Vertical Location

Follow below picture to adjust the vertical location.

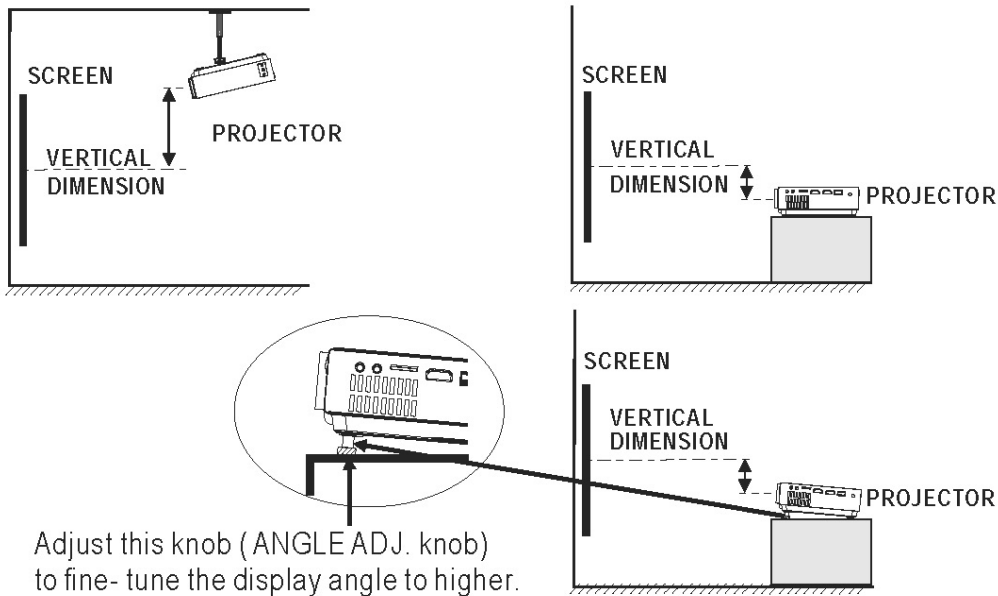

Adjust The Focus And Keystone

Follow below picture to adjust the focus and trapezoidal screen.

Adjust the focus by turning the knob while observing the image pixels near the center of the screen. Optimal focus is obtained when the pixels are clearly visible. Depending on the projected screen size, the focus near the screen edges may be less sharp than the screen center.

Keystone image is created when the projector lens is projected from above or below the center of the screen. Keystone correction restores the distorted image to a rectangular or square shape.

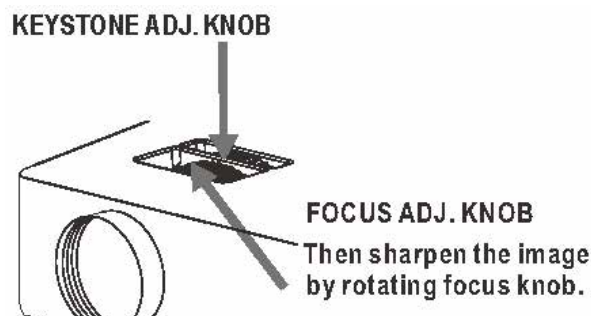

Controls of Remote

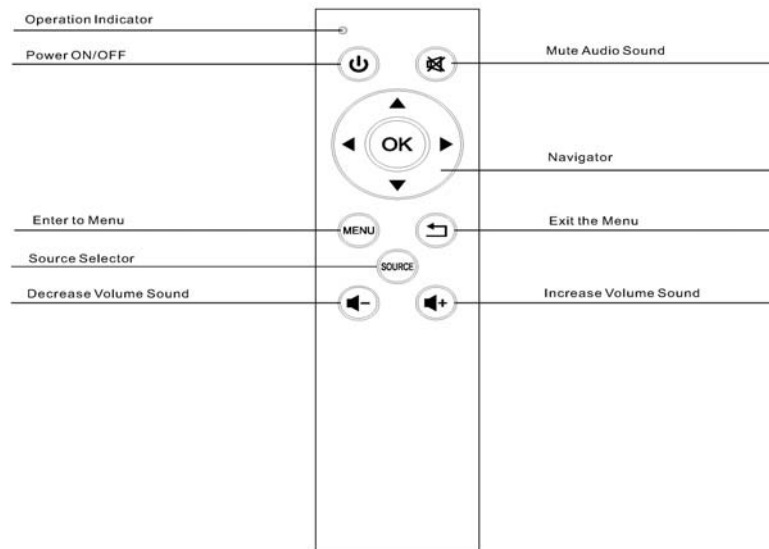

Install / Remove Batteries of Remote

Remove the battery compartment cover on the back of your remote by carefully sliding to open. The battery cover can then be lifted away. Fit the correct batteries (not included), referring to the polarity markings. Finally, replace the cover.

NOTES:

- Batteries shall not be exposed to excessive heat such as placing under the sunlight or near a fire.
- Please make sure the batteries are installed with their correct polarities.
- Do not mix old and new batteries.
- Use only the same type of batteries.
- Do not dispose of the batteries in fire, battery may explode or leak.
- Do not recharge a non-rechargeable battery.

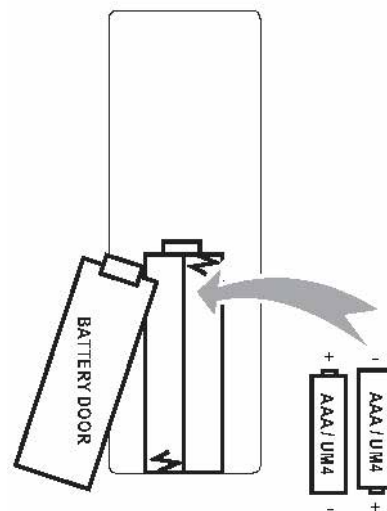

Controls of Carrying Case

Top View

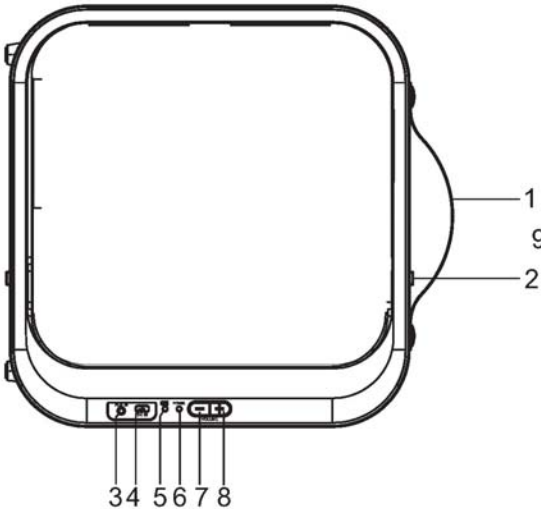

Bottom View

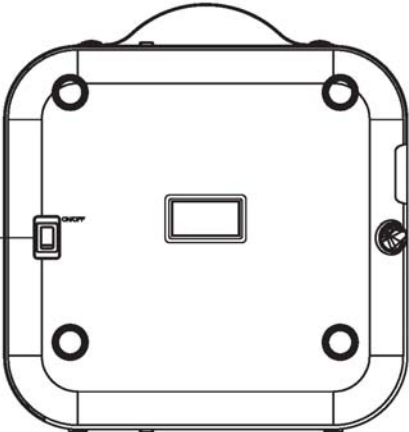

Left Side View

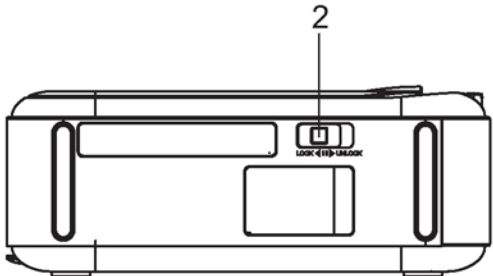

- | | | | |
|---|---|---|-----------------------------------|
| 1 | HANDLE | 6 | POWER Indicator |
| 2 | COVER LOCK | 7 | VOLUME - |
| 3 | AUX IN jack | 8 | VOLUME + |
| 4 | DC IN type C jack (for charging) | 9 | CARRYING CASE POWER ON/OFF |
| 5 | CHARGE Indicator | | |

Controls of Projector

Front View

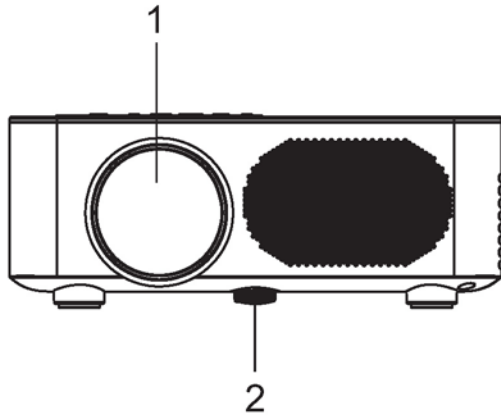

Rear View

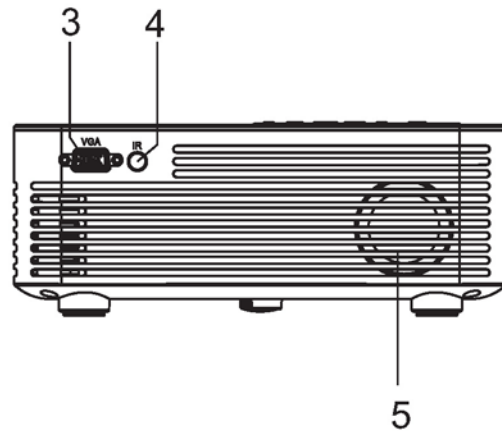

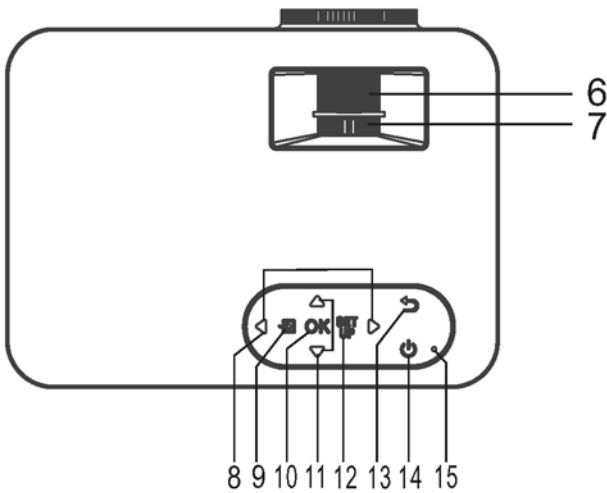

Top View

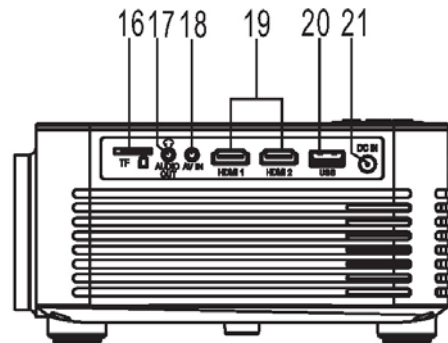

Right Side View



- | | | | |
|----|---|----|--|
| 1 | LENS | 12 | SETUP Button |
| 2 | ANGEL ADJ. Knob | 13 | RETURN  Buttons |
| 3 | VGA IN Port | 14 | POWER  Button |
| 4 | IR Sensor | 15 | POWER Indicator |
| 5 | Speaker | 16 | TF Card Slot |
| 6 | FOCUS ADJ. Knob | 17 | Audio Out Jack |
| 7 | TRAPEZOIDAL ADJ. Knob | 18 | AV IN Jack |
| 8 | ◀ ▶ Buttons | 19 | HDMI 1 & 2 Ports |
| 9 | SOURCE  Button | 20 | USB Port |
| 10 | OK Button | 21 | DC IN Jack |
| 11 | ▲ ▼ Buttons | | |

Install Power Adapter

Follow below picture to connect power adapter.

Connect small end of adapter **FIRST**. Plug the adapter body to power outlet.

WARNING:

Before connecting to the power supply, ensure that the supply corresponds to the information on the rating label at the back of the apparatus.

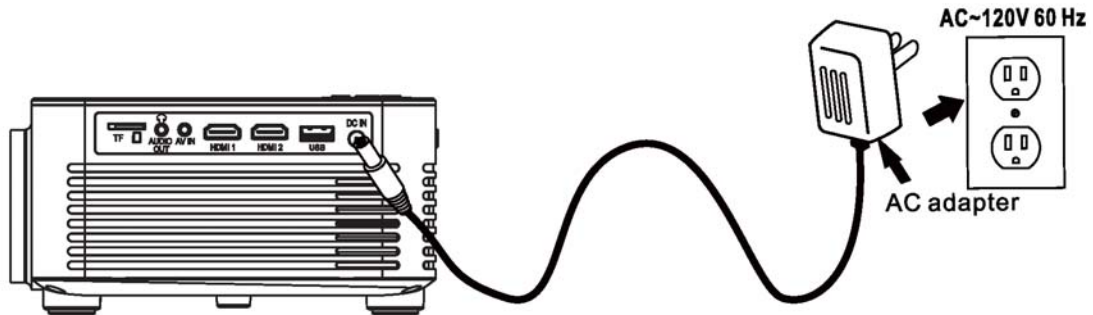



Main Button Operation

 - Press the button to switch on unit, press again to turn off.

 / **SOURCE** - Press the button to select input source.

 / **MENU** - Press the button to enter projector menu.

 - Press the buttons to navigate and select screen item of menu.

 / **EXIT** - Press the button to return to previous status or exit the menu.

 - Press the buttons to fast search forward and rewind on USB / TF.

 - Press the buttons to search next or previous file on USB / TF.

VOL+ / VOL - Press the buttons to select the sound level.

 - Press the button to play/pause the playback of file on USB / TF card.



FLIP – Press the button to rotate / mirror projector screen

ZOOM - Press the button to select image scale.

 - Press to mute the audio. Press again to resume.

Connect HDMI Show The Image On Projector Screen

Refer to the following picture to connect a set top box, a BD/DVD player or a streaming player to the HDMI input.

1. Turn off the unit before connect HDMI cable.
2. After connection, press the  button to turn on unit and power indicator will light GREEN
3. Press the  / **SOURCE** button to select HDMI 1 or HDMI 2 and the video from the connected device will be shown on projector screen.
4. Press the  button to turn off unit power.

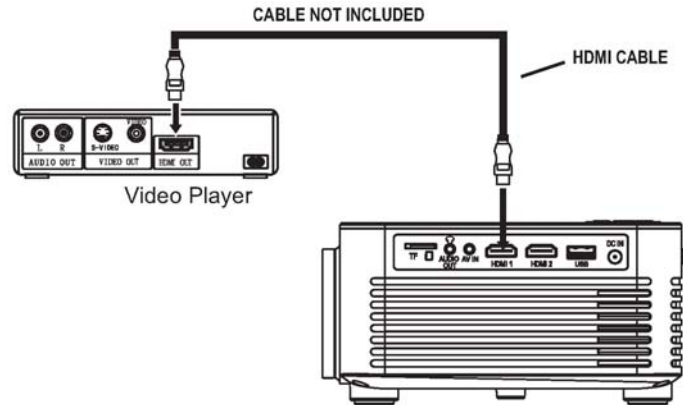



Important Note:

If there is no sound from the internal speakers when playing media contents from a set top box, BD/DVD or streaming players connecting to the HDMI input, please check the set top box or the player's digital audio settings and make sure it is set to "PCM Stereo" mode.

Connect AV Show The Image On Projector Screen



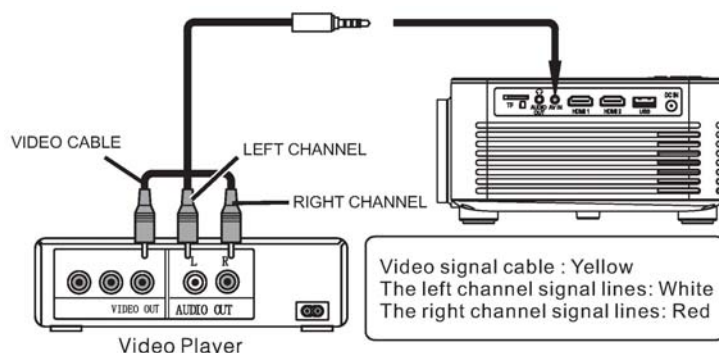

Follow below picture to connect AV cable and device.

1. Turn off the unit before connect AV cable.
2. Use AV cable to connect follow below figure
3. After connect, press the  button to turn on unit and power indicator will light GREEN
4. Press the  / **SOURCE** button to select AV mode and the video of AV device will show on projector screen
5. Press the  button to turn off unit power



Connect VGA Show The Image On Projector Screen

Follow below picture to connect VGA cable and device.

1. Turn off the unit before connect VGA cable.
2. Press the  button to turn off power of your projector before connection.
3. After connect, press the  button to turn on unit and power indicator will light GREEN
4. Press the  / **SOURCE** button to select PC mode and the video of VGA device will show on projector screen
5. Press the  button to turn off unit power.

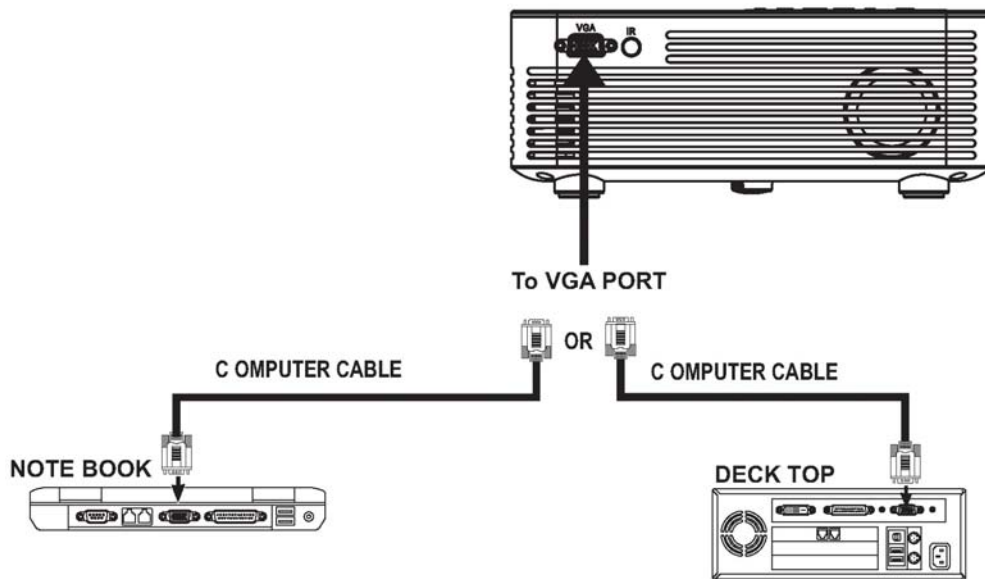

Please refer to the following table to adjust the output signal from computer

Type	Resolution		Frequency	Field Frequency
PC	VGA	640x480	31.5	60
			34.7	70
			37.9	72
			37.5	75
	SVGA	800x600	31.4	50
			35.1	56
			37.9	60
			46.6	70
			48.1	72
	XGA	1024x768	46.9	75
			40.3	50
			48.4	60
56.5			70	

NOTE: In order to get the sound from the unit, please connect AV IN cable when you connect VGA input.

Connect Audio Output (Aux Out / Line Out / Earphones)

Follow below picture to connect audio cable and device.

1. Press the  button to turn off power of your projector before connection.
2. Use audio cable to connect follow below figure.
3. After connect and turn on both units. Your projector sound from external device now.
4. After using , turn off both unit

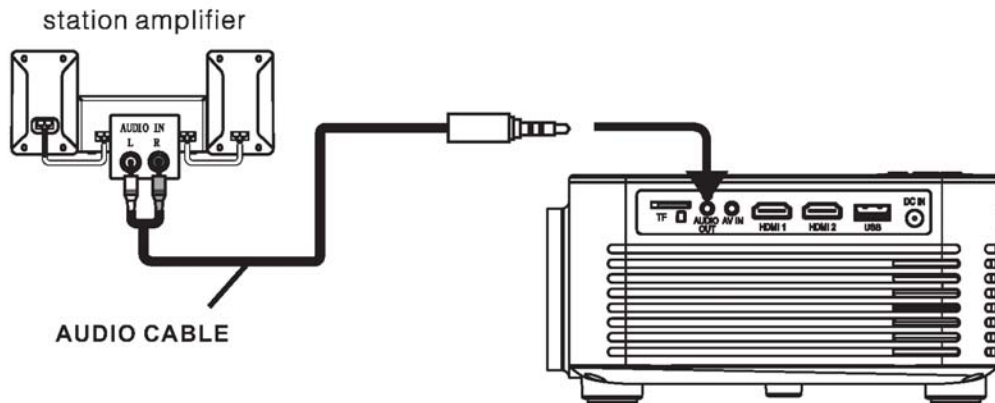

Important Note:

If there is no sound from the stereo audio output when playing media contents from a set top box, BD/DVD or streaming players connecting to the HDMI input, please check the set top box or the player's digital audio settings and make sure it is set to "PCM Stereo" mode.

Install USB Device And Micro SD Card “TF”





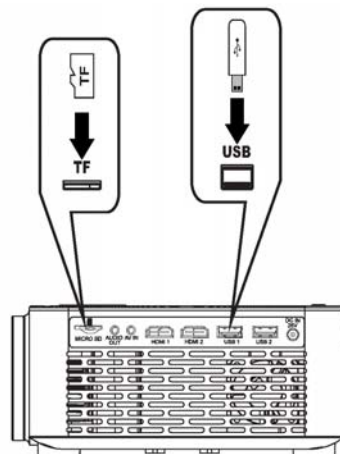

















Follow below picture to install USB and TF card

Turn off the unit before install USB / TF card.



















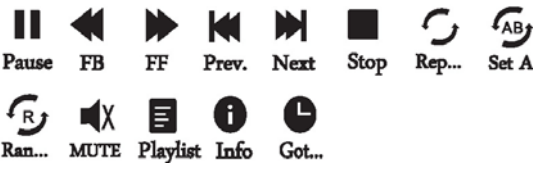

Using TF Card And USB Playback (Media Player)

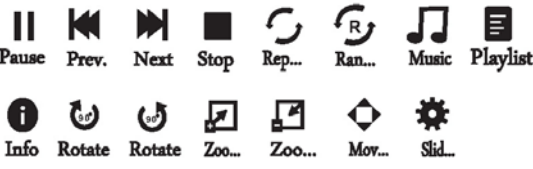
Install USB / TF device:

1. Turn off the unit before install USB / TF card.
2. Install the USB device into USB port or install TF card into TF port.
3. After connect, press the  button to turn on unit and the power indicator light GREEN.
4. Press the  / **SOURCE** button to enter and use  /  buttons to search the **DMP** (USB or TF Card / micro SD) mode.
5. After selection, use  /  buttons to search the MOVIE / MUSIC / PHOTO / TEXT icon and press the  button to enter. If necessary, use the  /  button to select TF card or USB and press the  button to enter.
6. Use     /  buttons to search the correct file and press the  button to preview playback file and press the  / **EXIT** button or  button of remote to start playback.
7. Press  /  button to fast search forward and rewind.
8. Press  /  button to search next or previous file.
9. During playback, press the  button to pause and press again to resume.







NOTE: Remove USB / TF device, press the  button to turn off power **FIRST**.

Sub-Menu on Movie screen	
<p>1. When movie playback, press the  button and more function screen show on lower (figure 1).</p> <p>2. Use the  /  button to select icon and press the  button to play special function.</p>	<p>Figure 1.</p> 
Sub-Menu on Music screen	
<p>1. When music playback, press the  button and more function screen show on lower (figure 2).</p> <p>2. Use the  /  button to select icon and press the  button to play special function.</p>	<p>Figure 2.</p> 
Sub-Menu on Photo screen	
<p>1. When photo playback, press the  button and more function screen show on lower (figure 3).</p> <p>2. Use the  /  button to select icon and press the  button to play special function.</p>	<p>Figure 3.</p> 
Sub-Menu on Text screen	
<p>1. When text playback, press the  button and more function screen show on lower (figure 4).</p> <p>2. Use the  /  button to select icon and press the  button to play special function.</p>	<p>Figure 4.</p> 

Using Bluetooth Playback







Pairing is the term used when two Bluetooth devices are connected wirelessly for the first time. This allows the devices to see each other and sets up a one to one communication channel between both devices.

Bluetooth Connection

1. Press the  button to turn on unit and the power indicator light GREEN.
2. Press  / **MENU** button to enter projector menu, press  /  buttons to select **SOUND** menu
3. Use the  /  button to select Bluetooth column.
4. Press the  button to turn “ON”
5. Turn on your External Bluetooth Speaker and select to Bluetooth pairing mode.
6. A few seconds, you hearing “melody” sound that your unit and external Bluetooth speaker connected.
7. After connection completed, you can now play music from the unit to External Bluetooth speaker.

Sound Mode	Standard
Balance	0
Auto Volume	Off
Bluetooth	Off

Disconnect the Bluetooth

1. Press the  / **MENU** button to enter the projector menu, press  /  buttons to select **SOUND** menu
2. Use the  /  button to select Bluetooth column
3. Press the  button to turn “Off” the Bluetooth connection. The unit will emit two short beeps.

Carrying Case for AUX IN Operation

If you want to have better sound from the speaker, you can connect the audio cable from projector’s Audio out port to carrying case’s AUX IN port. The step as below.

1. Connect a 3.5mm Auxiliary Cable to Audio out jack on side of unit and to AUX IN port on carrying case.
2. Turn on both units (Carrying Case on/off switch on the bottom).
3. After the connection, the speaker of carrying case will sound.
4. Adjust the Volume to desire conform level on carrying case.

Charging Carrying Case Battery

Plug the included USB (type C) cable to **DC INPUT** jack of carrying case and plug the other end to computer USB output port or external adapter output port.

After connection, the **CHARGE INDICATOR** will turn Red to Off when the built-in battery is fully charged.

Rechargeable Battery Operation

1. This unit will also operate using the built-in Lithium rechargeable battery. Fully charge the built-in rechargeable battery before first use, the CHARGE INDICATOR will turn from Red to Off when the built-in battery is fully charged.
2. Slide the power switch to on position at the bottom of carrying case, unplug the **DC INPUT** USB (type C) jack of carrying case. The unit will enter Battery Operating mode automatically.

Using Projector Menu 1

Press **≡** / **MENU** button to enter projector menu, press **◀/▶** buttons to select **PICTURE** menu.

Picture Mode	Medium
Color Temperature	Medium
Aspect Ratio	16:9
Noise Reduction	Middle
Screen	
Reduce Display Size	100%
Projection Direction	Front

This Picture menu showed on right upper of view screen.

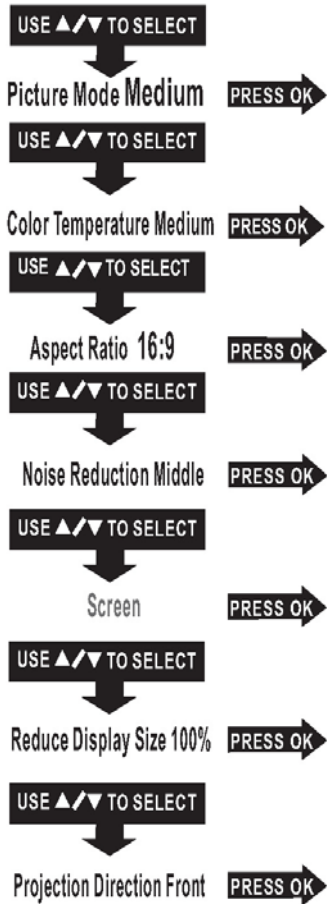

Use **◀/▶** to select different picture effect to Medium / Soft / User / Vidid. Use **◀/▶** or **▲/▼** to select Contrast / Brightness / Color / Sharpness digit If chose User item. Follow below figure.

Use **◀/▶** to select different color temperature to Medium / Warm / User / Cool. Use **◀/▶** or **▲/▼** to select Red / Green / Blue digit If chose User item. Follow below figure.

Use **▲/▼** buttons to select screen ratio AUTO / 4:3 / 16:9. Follow below figure.

Use **▲/▼** buttons to select Off / Low / Middle / High / Default.

Use **▲/▼** buttons to select Auto Adjust / Horizon Pos. / Vertical Pos. / Size / Phase. Use **◀/▶** or **▲/▼** to select Horizon Pos. / Vertical Pos. / Size / Phase digit. Follow below figure

Use **◀/▶** button to select different zoom scale digit 75% - 100%

Press **Ⓞ** buttons repeatedly to select Front / Rear Ceiling / Front Ceiling / Rear

Picture Mode	
Customer define	Parameter
Contrast	0-100
Brightness	0-100
Color	0-100
Sharpness	0-100



Color temper... (temperature)	
Customer define	Parameter
red	0-100
blue	0-100
green	0-100

Aspect Ratio	
AV mode	Auto, 4:3, 16:9, Zoom1 ,Zoom2
HDMI mode	Auto, 4:3, 16:9, Zoom1, Zoom2, Just Scan
VGA mode	Auto, 4:3, 16:9, Point To Point
USB mode	Auto, 4:3, 16:9
TF Card mode	Auto, 4:3, 16:9

PC Setting (Active in VGA mode)	
Customer define	Parameter (Press ◀/▶ to set)
Horizon Pos.	0-100
Vertical Pos.	0-100
Size	0-100
Phase	0-100

Noted: PC setting menu is activated in VGA mode only

Using Projector Menu 2

Press  / **MENU** button to enter projector menu, press  /  buttons to select **SOUND** menu.







Sound Mode	Standard
Balance	0
Auto Volume	Off
Bluetooth	Off

This **sound** menu showed on right upper of view screen.

USE  /  TO SELECT

Sound Mode Standard

PRESS OK

Use  /  to select different sound effect Standard / Music / Movie / Sports / User. Use  /  or  /  to select Bass and Treble digit if chose User item. Follow below figure to set digit.

USE  /  TO SELECT

Balance 0

PRESS OK

Use  /  to select Balance level to -50 to +50.

USE  /  TO SELECT

Auto Volume Off

PRESS OK

Press  buttons to select Off / On.

USE  /  TO SELECT



Bluetooth Off

PRESS OK

Press  buttons to select Off / On

Sound Mode - User	Parameter
Treble	0-100
Bass	0-100

Using Projector Menu 3

Press  / **MENU** button to enter projector menu, press  /  buttons to select **OPTION** menu.





OSD Language	English
Restore Factory	Default
Color Range	0~255
Software Update (USB)	

This **OPTION** menu showed on right upper of viewing screen.

USE  /  TO SELECT

OSD Language English



PRESS OK

Use  /  or  /  button to select different language. Follow below figure

USE  /  TO SELECT

Restore Factory Default

PRESS OK

Use  /  buttons to select Y or N. If choose "Y" that your unit will go to factory default setting.

USE  /  TO SELECT

Color Range 0~255

PRESS OK

Press  buttons repeatedly to select different Color Range 16-235 / Auto / 0-255 (Noted: this setting menu is activated in HDMI mode only)

USE  /  TO SELECT

Software Update (USB)

PRESS OK

For service center use only.

Czech	English	France	Magyar	Polski	Romnete	Suomi	Korean
Dansk	Español	Hrvatski	Nederlands	Portugues	Slovenina	Svenska	SimpleCh...
Deutsch	Ελληνικ	Italiano	Norsk	Русский	Srpski	Japanese	

Specifications

Light Source Type	LED
Display Native Resolution	1280 x 720 RGB
HDMI Input Supported Video Resolution.	1080p , 1080i , 720p, 576i , 480p, and 480i
Power Consumption	70W
Included Adapter	Input AC100-240V, 50/60Hz Output DC26V, 2.3A
Projection Size	36-150 inch
Input Port	AV/ VGA / HDMI
USB Port	Support USB device up to 32GB Support format Mpeg1, Mpeg2, Mpeg4, mp3, Jpeg
TF Card	Support SD card up to 32GB Support format Mpeg1, Mpeg2, Mpeg4, mp3 , Jpeg
Net Weight	1.2 KG (Projector unit)
Product Dimensions	240 x 184 x 94 mm (Projector unit) 300 x 296 x 118 mm (Carrying Case)

Specifications are typical, individual units might vary. They are subject to continuous improvement without notice and without incurring any obligation.