

# SMD CERAMIC ANTENNA

## Data Sheet

---

---

# HZ1608WA01

## CS-2450-16-A

For 2400-2500MHz

1.6x0.8x0.4mm [EIA1608]

Manufacturer: Shenzhen Haizhe Technology Co., Ltd.

Address: C3, Building A1, Red Box Creative Park, No. 11 Huancheng South Road,  
Ma'antang Community, Bantian Street, Longgang District, Shenzhen

---

---

### Feature

- Light weight, compact
- Wide bandwidth, low cost
- Built-in antenna with high gain
- Operating Temp. : -40°C~+85°C

### Application

- Bluetooth
- WLAN 2.4
- WiFi 5/6/6E
- UWB



CS-2450-16-A

### Electrical Characteristics per line(TA=25°C)

Parameter	Specification	Units
Frequency Band	2400~2500	MHz
Polarization	Linear	
*Peak Gain	2.78	dBi
*Peak Efficiency	80.25	%
Impedance	50	$\Omega$

Test condition: Test board size 70\*60 mm;  
 Matching circuit: Pi matching circuit will be required.

### Product Dimension

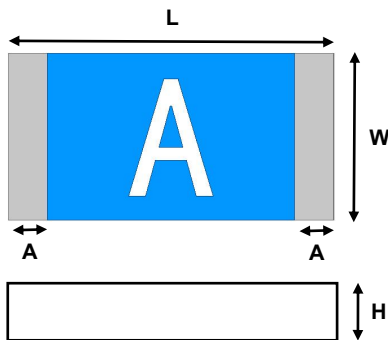

Units:mm

L	W	H	A
1.60±0.20	0.80±0.20	0.40±0.10	0.2±0.07

## Recommend PCB Layout1

Test condition: Test board size 70\*60 mm;

### Top Layer (unit mm)

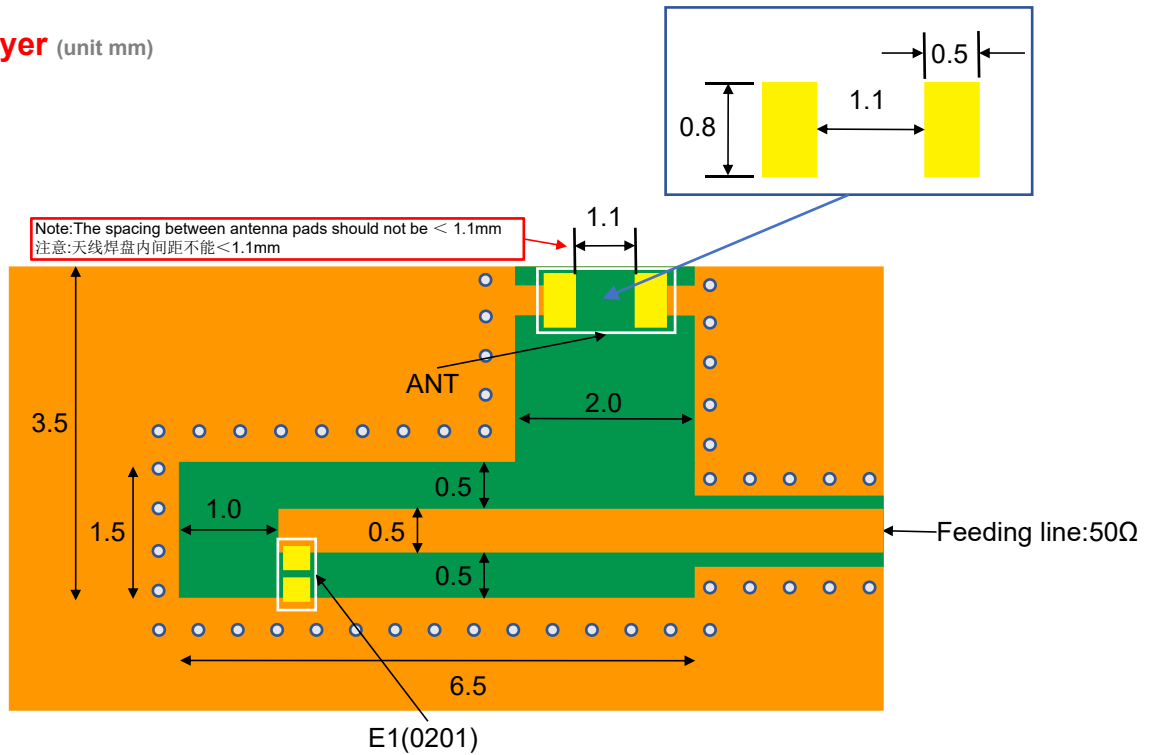

### Bottom Layer (unit mm)

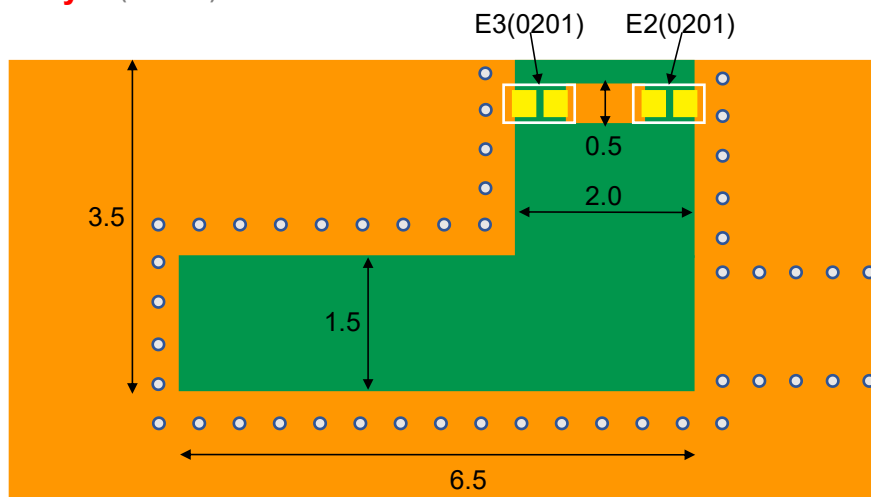

## Recommend PCB Layout2

Test condition: Test board size 70\*60 mm;

### Top Layer (unit mm)

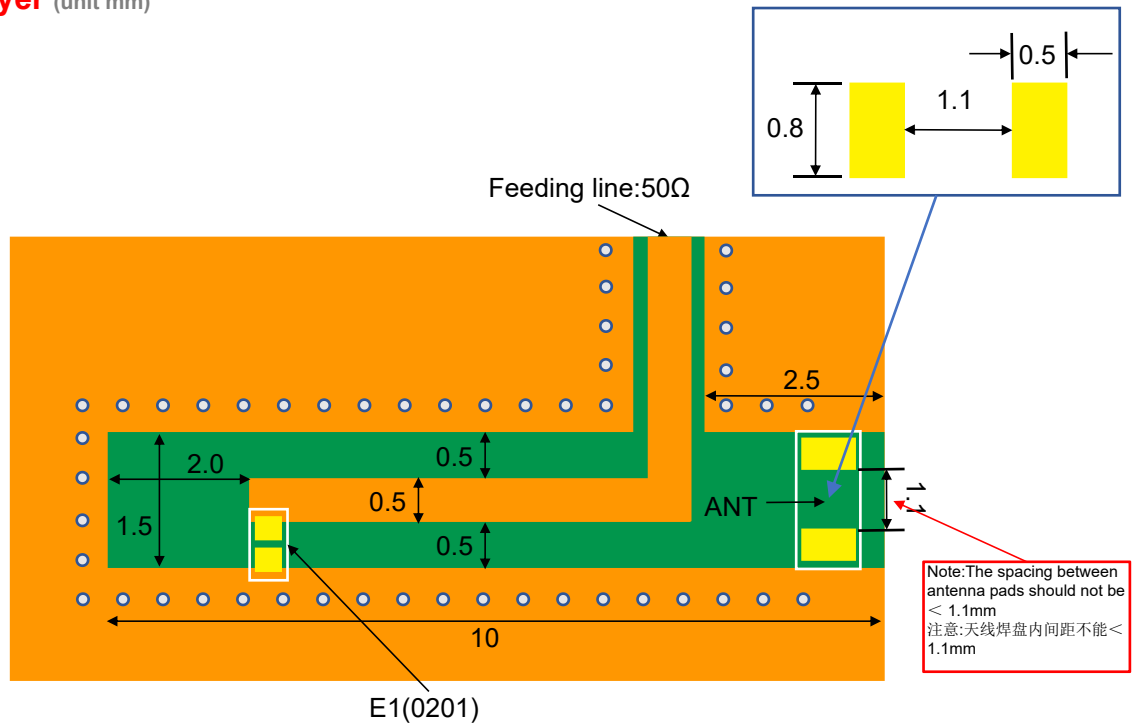

### Bottom Layer (unit mm)

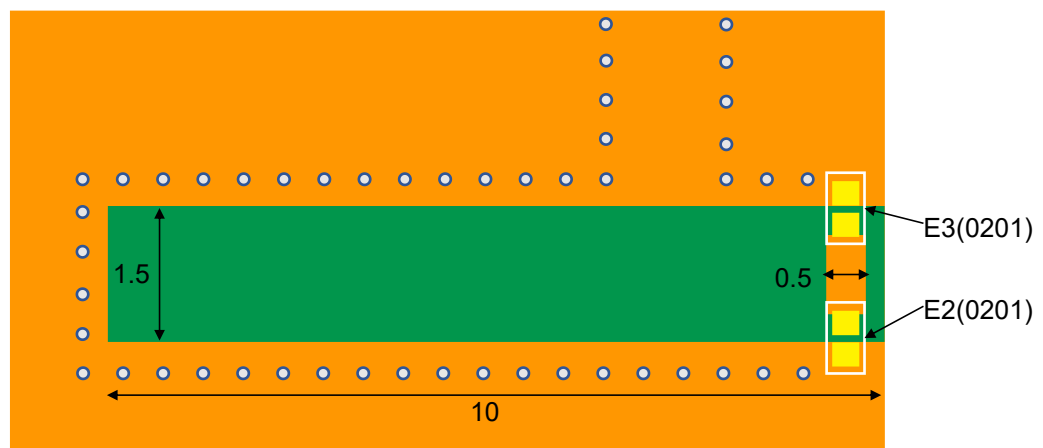

## Typical Characteristics

Fig. 1 Return Loss

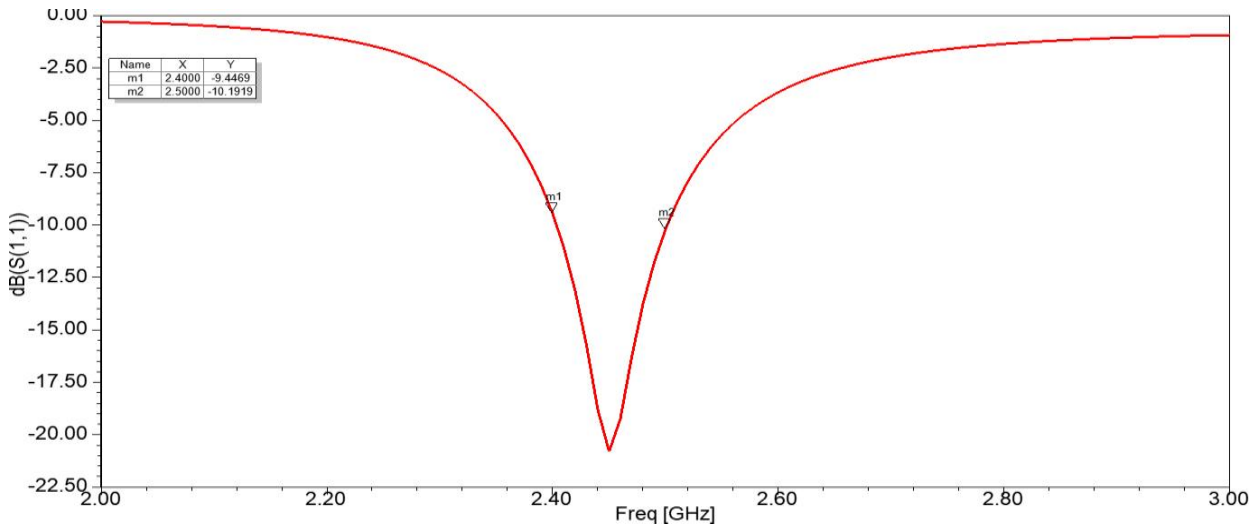

## Radiation Pattern

The Gain pattern is measured in FAR -field chamber. DUT is placed on the table of rotator , a standard horn antenna and Vector Network Analyzer is used to collect data.

Fig.2 FAR-field Chamber

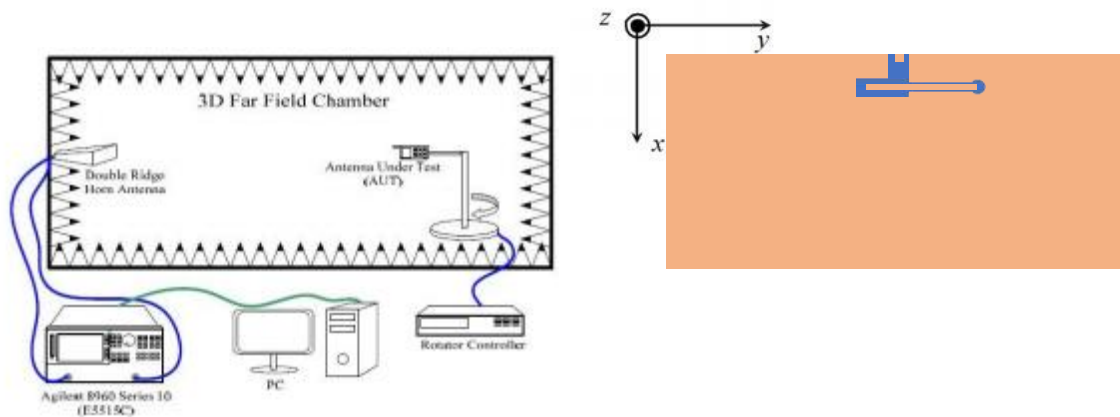

Equivalent circuit:

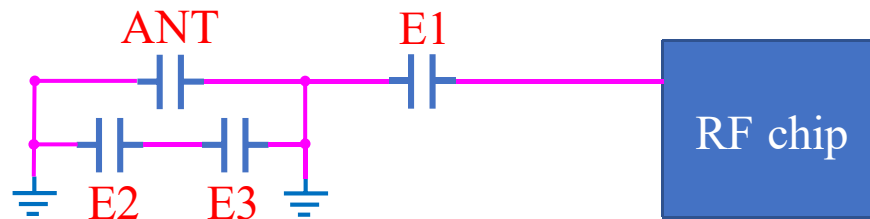

2D Gain Pattern

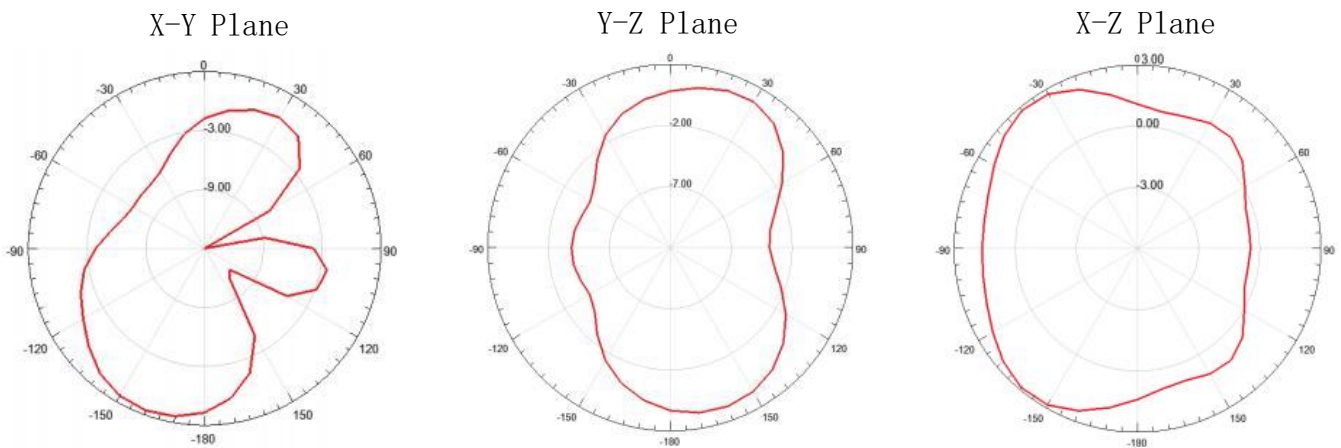

Radiation Performance:

Frequency	2400MHz	2450MHz	2500MHz
Avg. gain	- 1.92	- 1.35	- 1.56
Peak gain	1.79	2.78	2.66
Efficiency	74.55	80.25	76.98

Item	Condition	Specification
Thermal shock	1. 30±3 minutes at -40°C±5°C, 2. Convert to +105°C (5 minutes) 3. 30±3 minutes at +105°C±5°C, 4. Convert to -40°C (5 minutes) 5. Total 100 continuous cycles	No apparent damage Fulfill the electrical spec. after test.
Humidity resistance	1. Humidity: 85% R.H. 2. Temperature: 85±5°C 3. Time: 1000 hours.	No apparent damage Fulfill the electrical spec. after test.
High temperature resistance	No apparent damage Fulfill the electrical spec. after test.	1. Temperature: 150°C±5°C 2. Time: 1000 hours.
Low temperature resistance	1. Temperature: -40°C±5°C 2. Time: 1000 hours.	No apparent damage Fulfill the electrical spec. after test.
Soldering heat resistance	1. Solder bath temperature : 260±5°C 2. Bathing time: 10±1 seconds	No apparent damage
Solderability	The dipped surface of the terminal shall be at least 95% covered with solder after dipped in solder bath of 245±5°C for 3±1 seconds.	No apparent damage

## (2) Storage Condition

(a)At warehouse: The temperature should be within 0 ~ 30°C and humidity should be less than 60% RH.The product should be used within 1 year from the time of elivery.

(b)On board: The temperature should be within -40 ~ 85°C and humidity should be less than 85% RH.

## (3) Operating Temperature Range

Operating temperature range : -40°C to +85°C.

## Recommended Reflow Solder curve

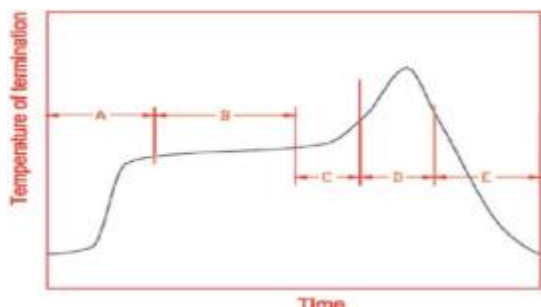

A	1 <sup>st</sup> rising temperature	The normal to Preheating temperature	30s to 60s
B	Preheating	140°C to 160°C	60s to 120s
C	2 <sup>nd</sup> rising temperature	Preheating to 200°C	20s to 40s
D	Main heating	if 220°C	50s~60s
		if 230°C	40s~50s
		if 240°C	30s~40s
		if 250°C	20s~40s
E	Regular cooling	if 260°C	20s~40s
		200°C to 100°C	1°C/s ~ 4°C/s

\*reference: J-STD-020C

(1) Soldering Gun Procedure

Note the follows, in case of using solder gun for replacement.

- (a) The tip temperature must be less than 350°C for the period within 3 seconds by using soldering gun under 30 W.
- (b) The soldering gun tip shall not touch this product directly.

(2) Soldering Volume

Note that excess of soldering volume will easily get crack the body of this product.

Package Information

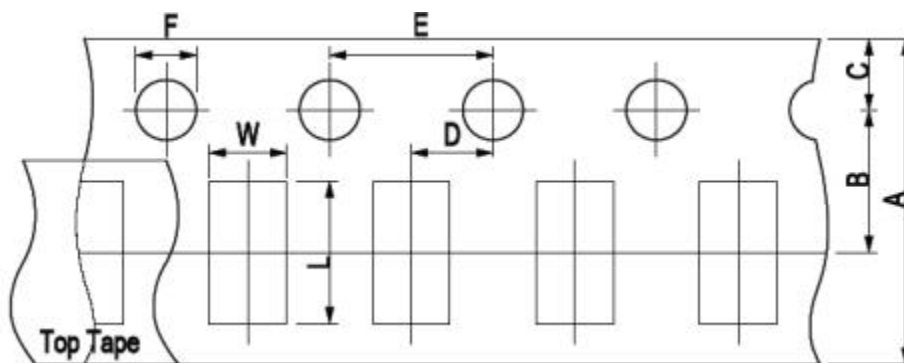

A	B	C	D	E	F	L	W
8.00±0.3	3.50± 0.05	1.75±0.1	2.00±0.05	4.00±0.1	1.50±0.1	2.30± 0.1	1.55± 0.1

Part Number System

CS - 2450 - 16-A

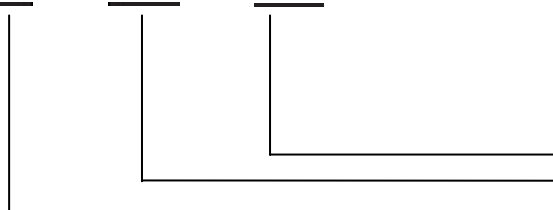

External Dimensions L\*W (mm) 1.6\*0.8  
 Central Frequency 2450 MHz  
 Product Series: Chip Antenna

Marking





## 订货信息 Order Information

Device	Package	Net Weight	Carrier	Quantity	HSF Status
CS-2450-16-A	1608	0.002g	Tape&Reel	5000pcs	RoHS compliant

## Revision history

Date	Revision	Description of changes
2023-01-03	1.0	First Version
2023-11-15	1.1	Add PCB Layout

The contents of this data sheet are subject to change without notice .  
Please confirm the specifications and delivery conditions when placing your order.