

## **Copyright Information**

Copyright © 2024 by SHENZHEN SMARTSAFE TECH CO.,LTD. All rights reserved. No part of this publication may be reproduced, stored in a retrieval system, or transmitted in any form or by any means, electronic, mechanical, photocopying, recording or otherwise, without the prior written permission of SMARTSAFE.

Neither SMARTSAFE nor its affiliates shall be liable to the purchaser of this unit or third parties for damages, losses, costs, or expenses incurred by purchaser or third parties as a result of: Accident, misuse, or abuse of this unit, or unauthorized modifications, repairs, or alterations to this unit, or failure to strictly comply with SMARTSAFE operating and maintenance instructions. SMARTSAFE shall not be liable for any damages or problems arising from the use of any options or any consumable products other than those designated as Original SMARTSAFE Products or SMARTSAFE Approved Products by SMARTSAFE.

All information, specifications and illustrations in this manual are based on the latest information available at the time of printing. SMARTSAFE reserves the right to make changes at any time without prior written or oral notice.

## **Trademark Information**

**SmartSafe** is a registered trademark of SHENZHEN SMARTSAFE TECH CO.,LTD. in China and other countries. All other SMARTSAFE trademarks, service marks, domain names, logos, and company names referred to in this manual are either trademarks, registered trademarks, service marks, domain names, logos, company names of SMARTSAFE or are otherwise the property of SMARTSAFE or its affiliates. In countries where any of the SMARTSAFE trademarks, service marks, domain names, logos and company names are not registered, SMARTSAFE claims other rights associated with unregistered trademarks, service marks, domain names, logos, and company names. Other products or company names referred to in this manual may be trademarks of their respective owners. You may not use any trademark, service mark, domain name, logo, or company name of SMARTSAFE or any third party without permission from the owner of the applicable trademark, service mark, domain name, logo, or company name. You may contact SMARTSAFE by visiting the website at [www.newsmartsafe.com](http://www.newsmartsafe.com), or writing to SHENZHEN SMARTSAFE TECH CO.,LTD., 3310, Building 11, Tianan Cloud Park, Bantian Street, Longgang District, Shenzhen, Guangdong, China, to request written permission to use Materials on this manual for purposes or for all other questions relating to this manual.

To avoid personal injury, property damage, or accidental damage to the product, please read all the information in this chapter before using the product.

This equipment is for professional technicians or maintenance personnel to use.

### **Precautions**

- Before installation and commissioning, please read this manual carefully, check the equipment list, and if you have any questions, contact the dealer or Smartsafe immediately.
- The installer must be a technical service personnel who has received relevant installation training from the company.
- The operator must undergo relevant product technical training approved by the company before they can take up the position.
- The operator must have a basic understanding of four-wheel alignment.
- The operator must have knowledge of the safe use of lifts and the safe maintenance of vehicles.
- After the vehicle maintenance is completed, all loosened bolts and components need to be checked and tightened as required to ensure safety.
- Do not install the WA913 wireless touchless wheel aligner on a vibrating object or a tilted surface. Avoid direct sunlight and moisture.
- Unauthorized disassembly of the equipment is prohibited to prevent component damage, affect detection, and increase difficulty and cost of maintenance. For damages caused by unauthorized disassembly, the company will not provide any warranty.
- The camera of the WA913 wireless touchless wheel aligner is a key optical component for detection and needs to be kept clean.

### **Safety Information**



Do not operate the four-wheel alignment system in a flammable and explosive environment.



Operators must provide appropriate fire protection measures at the measuring platform. Especially, do not store any flammable or self-igniting materials on the tool cart (such as cloth stained with oil or flammable solvents), and keep the equipment away from fire sources.





## Table of Contents



<b>1. Packing List</b> .....	<b>1</b>
<b>2. Overview</b> .....	<b>3</b>
2.1 Product Introduction .....	3
2.2 Features and Characteristics .....	3
2.3 Measurement Range .....	4
2.4 Operating Environment Requirements .....	4
2.5 Instructions for Use .....	5
<b>3. Instrument Structure</b> .....	<b>6</b>
3.1 Overall Structure .....	6
3.2 measuring unit Assembly .....	6
3.3 Calibration Unit Assembly .....	6
3.4 Charging base .....	7
<b>4. Four-Wheel Alignment Operation Steps</b> .....	<b>8</b>
4.1 Preparations .....	8
4.2 Routine Detection .....	8
4.3 Quick Inspection .....	24
4.4 Inspection Records .....	26
4.5 Database .....	28
4.6 Device Management .....	32
4.7 System Settings .....	33
4.8 Terms .....	38
<b>FCC Warning</b> .....	<b>44</b>

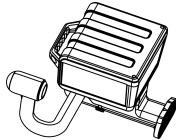
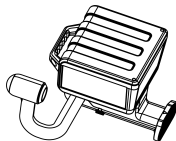
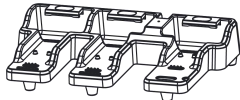
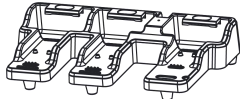

# 1. Packing List

The following list is for reference only. The configuration of the product varies for different markets, for details, please consult your local dealer or check the packing list that comes with the product.

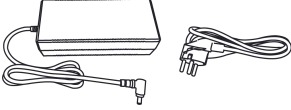
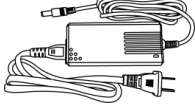
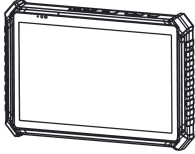
Main Unit and Accessories			
No.	Name	Quantity	Picture for Reference
1	Measuring Unit (FL)	1	
2	Measuring Unit (RL)	1	
3	Measuring Unit (FR)	1	
4	Measuring Unit (RR)	1	
5	Calibration Unit (ML)	1	
6	Calibration Unit (MR)	1	
7	Charging Dock (For Left Unit)	1	
8	Charging Dock (For Right Unit)	1	

9	Power Adapter - Charging Dock (12V 10A)	2	
10	Power Adapter - ST13 (12V 5A)	1	
11	ST13 Intelligent Link Terminal	1	
12	Installation Positioning Sticker	1	
13	Packing list	1	-
14	Quick Reference Guide	1	-
15	User Manual	1	-

## 2. Overview

### 2.1 Product Introduction

WA913 Wireless Touchless Wheel Aligner is mainly used to measure the relative positions and angles between car wheels in order to determine the wheel alignment parameters. This guides automobile maintenance technicians in adjusting the wheel alignment parameters to meet the requirements of automobile design, ensuring smooth and safe driving, reducing fuel consumption and tire wear.

It adopts a "touchless" measurement scheme, avoids the shortcomings of 3D measurement schemes, optimizes the four-wheel alignment detection process, reduces the requirements on the user, eliminates tire wear during the measurement process, and improves measurement accuracy and efficiency. It is a four-wheel alignment product that spans the 2D/3D era.

### 2.2 Features and Characteristics

- Touchless measurement, no need to install wheel clamps and targets, zero wheel hub wear.
- Industry-first magnetic suction design, ready to use out of the box, no assembly or wiring required; factory calibration-free.
- Simple and efficient, no need for a trolley, 30 seconds to generate four-wheel alignment measurement data.
- Compatible with multiple platforms, can be adapted to large scissor lifts and four-post lifts.
- With the ST13 intelligent link terminal, measurement data is wirelessly transmitted, allowing you to observe the measurement process and results at any time, making it convenient for chassis adjustment.
- Equipped with a large capacity removable battery, no need to connect to power during the measurement process, safer.
- Supports two types of four-wheel alignment measurement methods: standard measurement and quick measurement. It can measure key parameters such as toe-in, camber, caster, kingpin inclination, and thrust angle. It also supports additional measurements such as wheelbase, track width, axle offset, wheel offset, diagonal, and center offset.
- Covers four-wheel alignment data for over 50,000 global car models, and supports user customization.
- Generates professional detection reports, supports comparison of data before and after tuning, and supports report sharing.
- Equipped with two charging bases, which combine charging and storage.

## 2.3 Measurement Range

Vehicle Specifications Supported	
<b>Wheelbase:</b> 2150~3700 mm	<b>Track width:</b> 1430~1900 mm
<b>Wheel diameter:</b> 590~880 mm	<b>Tire width:</b> 165~325 mm

## 2.4 Operating Environment Requirements

<b>Operating temperature:</b> 0-45°C	<b>Operating humidity:</b> 20~90%
<b>Storage temperature:</b> -20~70°C	<b>Storage humidity:</b> 10~90%
<b>Atmospheric pressure:</b> 86kPa~106kPa	<b>ESD protection:</b> air discharge 8kV, contact discharge 4kV
<b>Lighting requirement:</b> No strong infrared light directly shining on the camera	<b>Lift way height difference:</b> front and rear difference < 2mm



## 2.5 Instructions for Use

The coordinated operation diagram of the WA913 wireless touchless wheel aligner is shown in Figure 2.1. The whole system is mainly composed of the data acquisition section and the ST13 intelligent link terminal.

The components of the data acquisition section consist of 4 measuring units and 2 calibration units.

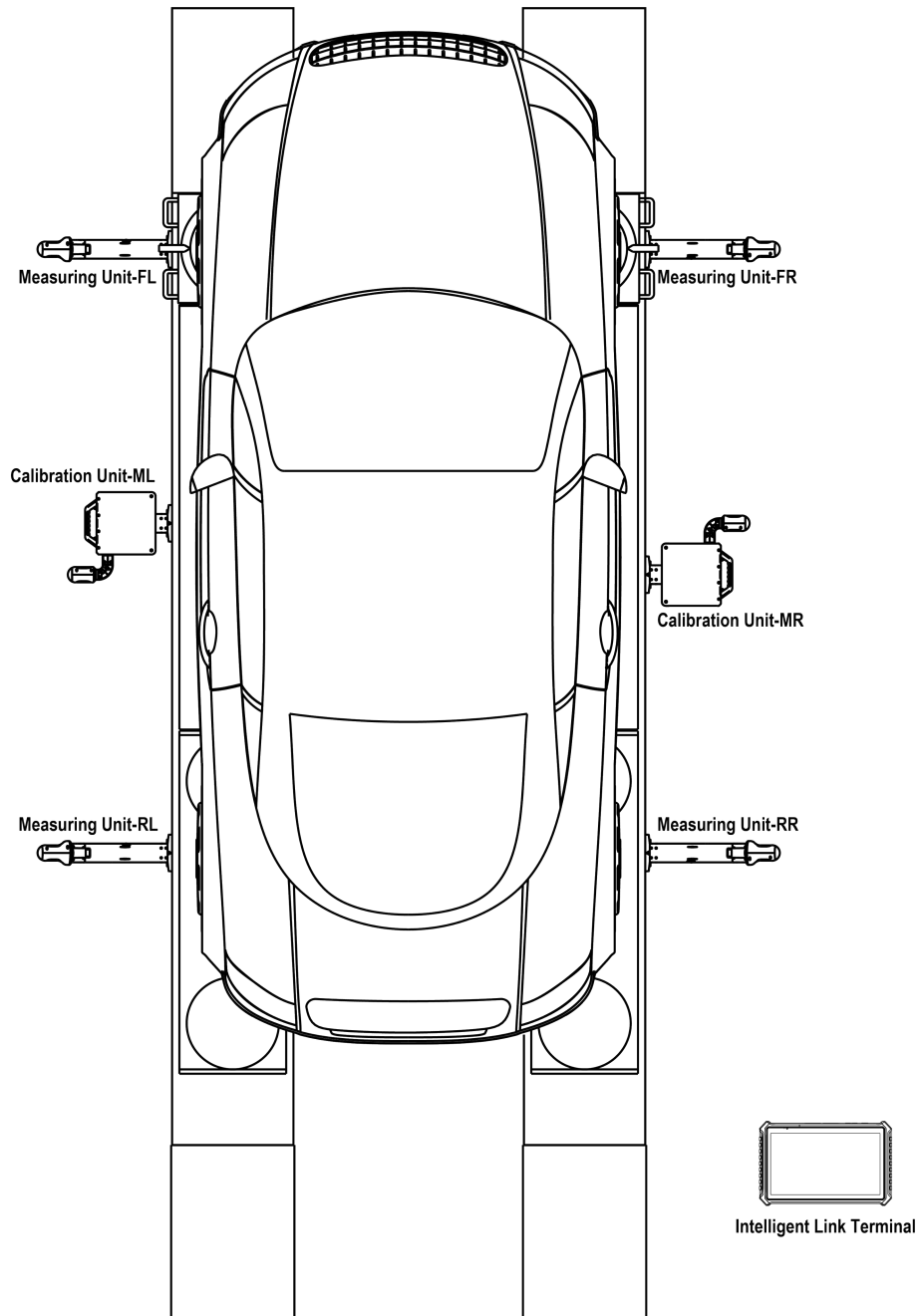

Figure 2. 1

### 3. Instrument Structure

#### 3.1 Overall Structure

The WA913 wireless touchless wheel aligner is mainly composed of measuring units (front right/front left/rear right/rear left), calibration units (middle right/middle left), and charging bases (right/left). ST13 intelligent link terminal, turntable (optional), steering wheel fixing bracket (optional), and brake pedal fixing bracket (optional) are combined with a standard four-post lift (optional).

*Note: The composition and accessories of different models of products are different. Please consult the dealer or refer to the product packing list for details.*

#### 3.2 measuring unit Assembly

The WA913 wireless touchless wheel aligner has four measuring unit assemblies (front right/front left/rear right/rear left), which are key components of the entire detection system (as shown in Figure 3.1).

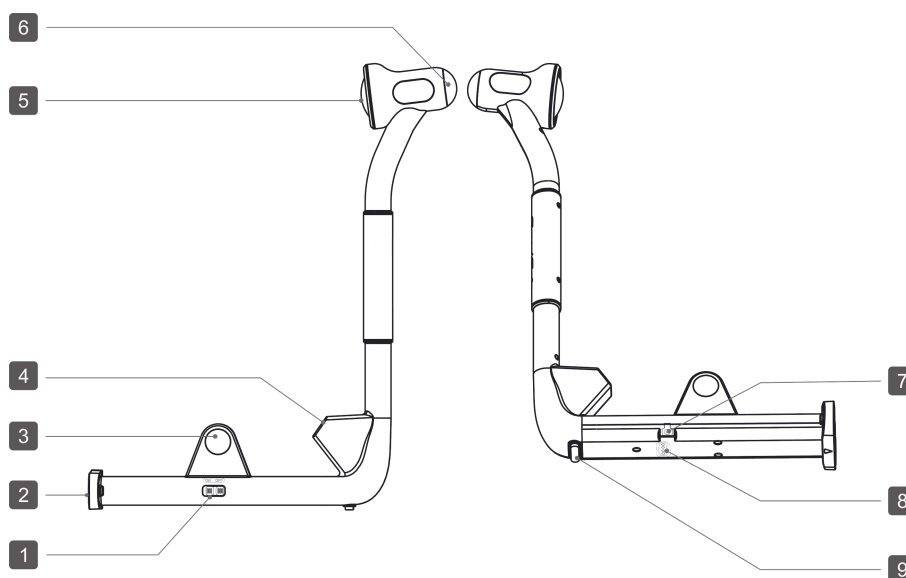

Figure 3.1

- |                       |                   |                      |
|-----------------------|-------------------|----------------------|
| ① Power Switch        | ④ Laser           | ⑦ Dc-In Power Socket |
| ② Magnetic Holder     | ⑤ Main Camera     | ⑧ Charging Base      |
| ③ Mutual-check Camera | ⑥ Indicator Light | ⑨ Rubber Pad         |

#### 3.3 Calibration Unit Assembly

The WA913 touchless wireless touchless wheel aligner has 2 calibration unit assemblies (middle right/middle left).

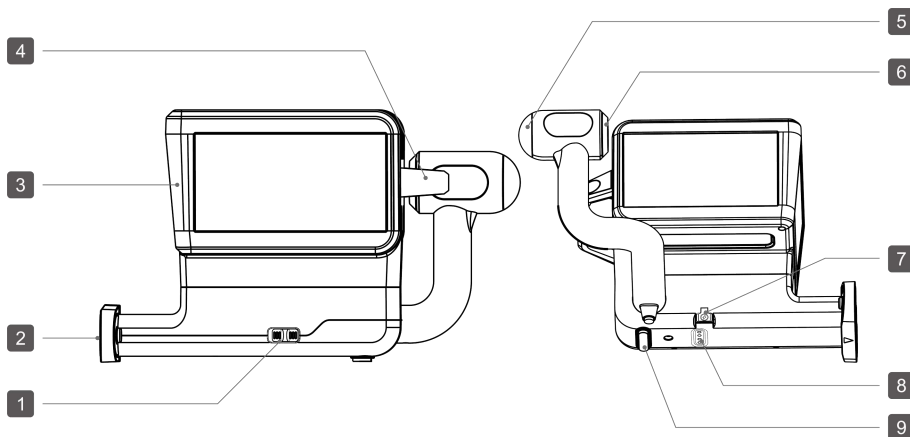

Figure 3.2

- |                   |                       |                      |
|-------------------|-----------------------|----------------------|
| ① Power Switch    | ④ Lifting Handle      | ⑦ DC-in Power Socket |
| ② Magnetic Holder | ⑤ Indicator Light     | ⑧ Charging Base      |
| ③ Calibration Box | ⑥ Mutual-check Camera | ⑨ Rubber Pad         |

### 3.4 Charging base

The WA913 wireless touchless wheel aligner has 2 charging bases (including a left charging base used to store the middle left calibration unit + rear left measuring unit + front left measuring unit, and a right charging base used to store the middle right calibration unit + rear right measuring unit + front right measuring unit). The charging bases come with the functions of storing the measuring units and calibration units, as well as charging them.

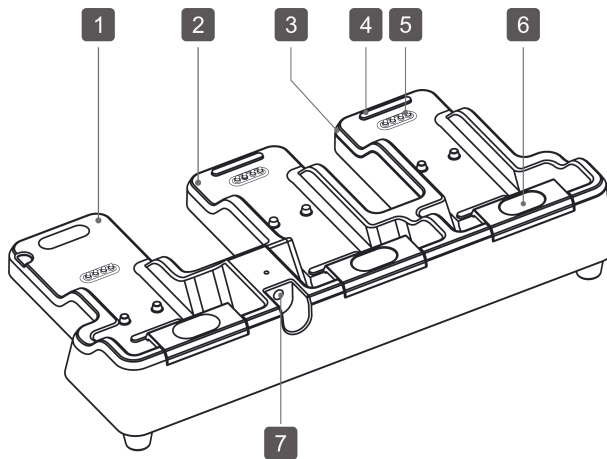

Figure 3.3

- |                                                   |                              |
|---------------------------------------------------|------------------------------|
| ① Charging And Storage Base For Calibration Unit  | ⑤ 4 Pin Mother Charging Base |
| ② Charging And Storage Base I For Measuring Unit  | ⑥ Charging Base Snap Lock    |
| ③ Charging And Storage Base II For Measuring Unit | ⑦ DC-in Power Socket         |
| ④ Rubber Pad                                      |                              |

## 4. Four-Wheel Alignment Operation Steps

### 4.1 Preparations

#### 4.1.1 Use of Positioning Sticker

The product comes with positioning stickers to assist with the installation of the equipment. Attach the positioning sticker about 1cm away from the surface of the lift platform and ensure that the positioning sticker is parallel to the surface of the lift platform.

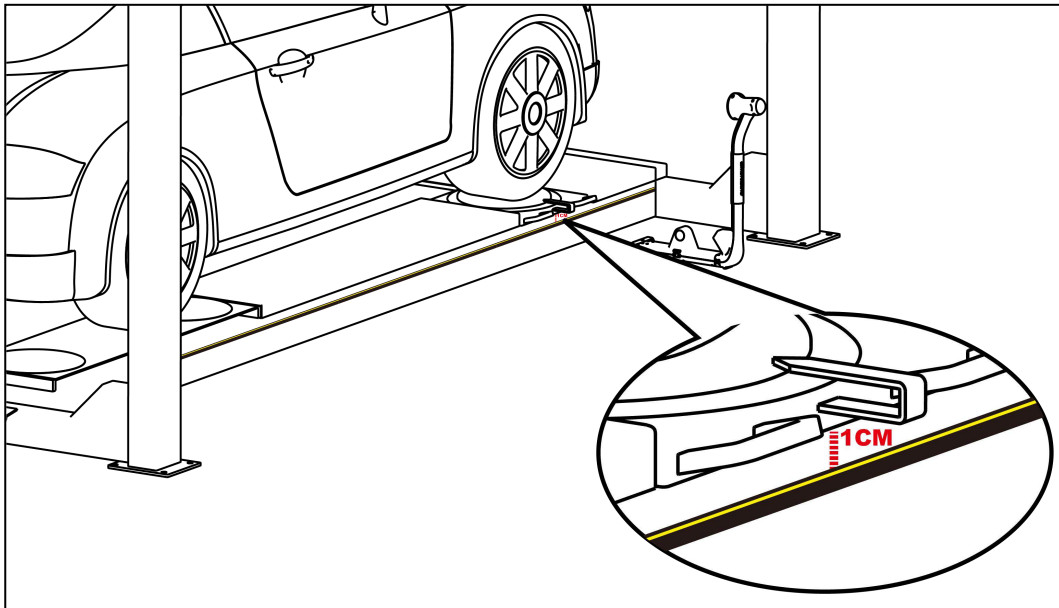

Figure 4.1

#### 4.1.2 Precautions

- Please do not touch the camera lens with your hands or any other tools. Please do not clean the camera lens with a cleaning cloth dipped in a cleaning agent.
- Handle the equipment with care to prevent collisions and falls.
- After using the measuring units and calibration units, they should be promptly placed back in the charging bases for storage and protection.

### 4.2 Routine Detection

Enter the main interface of the four-wheel alignment measurement by clicking on the **Four-Wheel Alignment** application on the tablet. The main interface displays 6 functions: four-wheel alignment, quick inspection, inspection records, database, device management, and system settings.

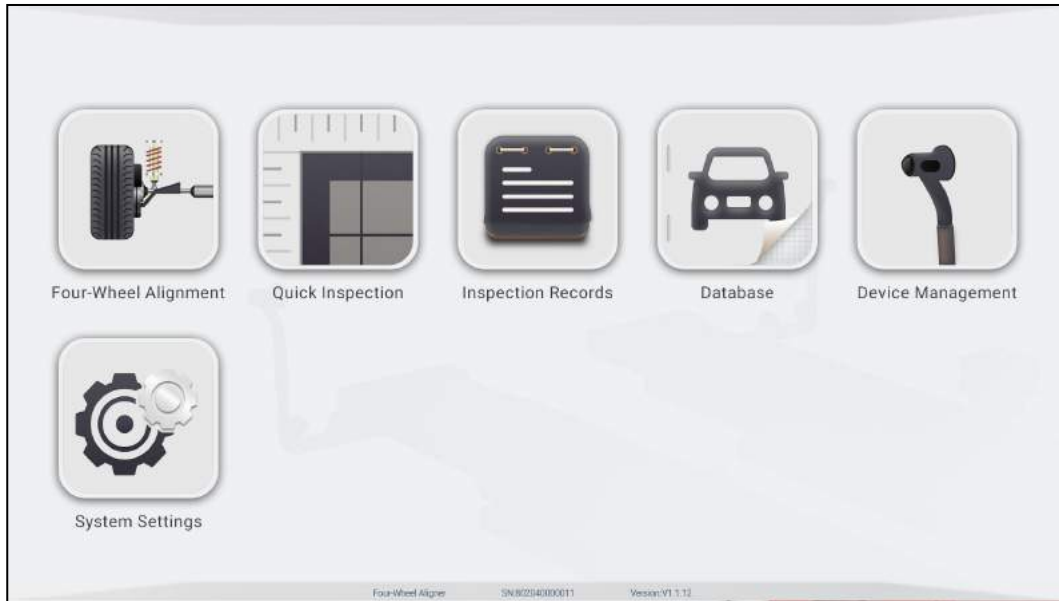

Figure 4.2

### 4.2.1 Vehicle Selection

Click on the **Four-wheel Alignment** icon on the main interface to enter the routine four-wheel alignment detection interface, and firstly select the vehicle.

According to the information of the vehicle to be detected, select the **Region -> Brand -> Model -> Year -> Configuration** in order, and then enter the **Car Info** interface.

*Note: You can enter relevant information in the search box at the top of the screen for quick search.*

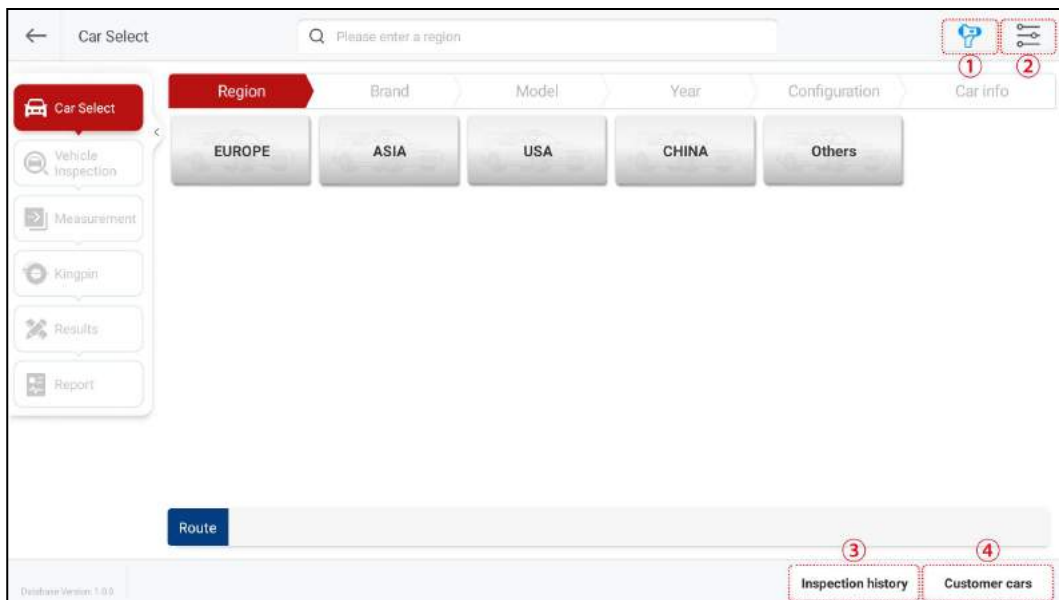

Figure 4.3

Screen button instructions are as follows:

<p>① <b>Equipment Status</b> (📶)</p>	<p>Clicking this button allows you to quickly view equipment status, battery level, network connection signal, and other information (when all devices are online, the icon is displayed in green 📶; when there is a low battery level, the icon is displayed in orange 🔋; when there is an equipment status abnormality or malfunction, the icon is displayed in red 🚨; when some devices are online or in the process of connecting, the icon is displayed in blue 📶).</p> <div data-bbox="598 584 1209 1021" data-label="Image"> </div> <p style="text-align: center;">Figure 4.4</p>
<p>② <b>System Settings</b> (⚙️)</p>	<p>Clicking this button will quickly take you to the <b>System Settings</b> interface.</p>
<p>③ <b>Inspection history</b></p>	<p>Used to directly select previously detected vehicles based on historical inspection records.</p>
<p>④ <b>Customer cars</b></p>	<p>To view the saved customer vehicle information for directly selecting the vehicle.</p>

In the **Car Info** interface, you can view the standard data of the vehicle, and you can also modify the configuration and add custom data as needed.

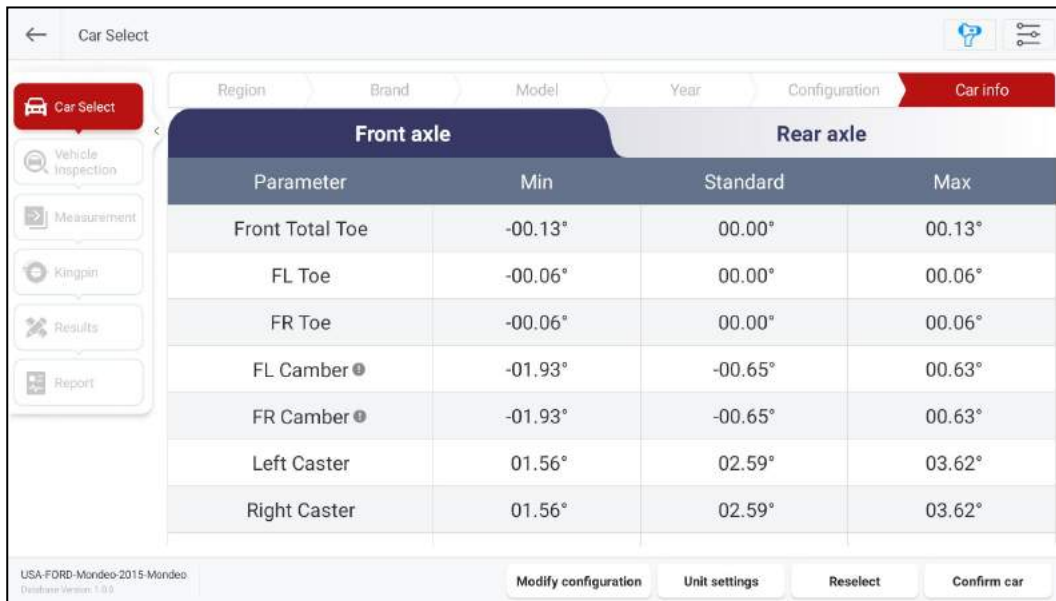

Figure 4.5

Screen button instructions are as follows:

This function is used to customize the configuration information. Click **Modify Configuration** to enter the following interface:

**Modify Configuration**

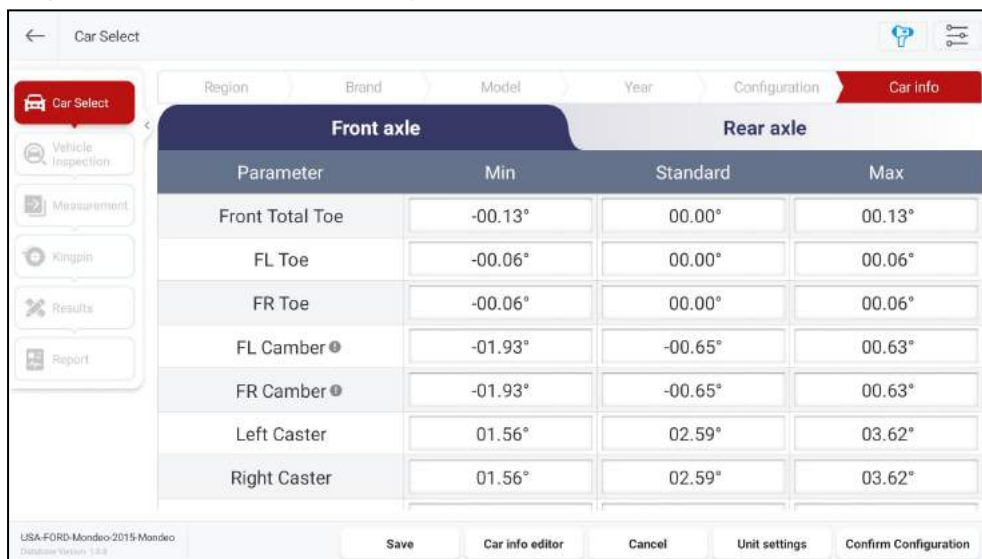

Figure 4.6

After modifying the parameter value, click **Save** and enter the configuration name in the pop-up window, and then click **OK** to save the modified configuration to the custom database.

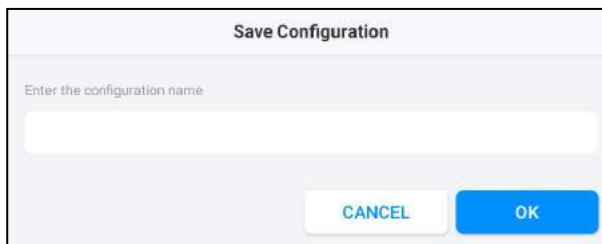

Figure 4.7

If you need to modify the model information of custom data, you can click **Car info Editor** to modify the corresponding information and then click **SAVE**.

The screenshot shows a dialog box titled "Car info editor". It has five input fields: "Region" with "USA", "Brand" with "FORD", "Model" with "Mondeo", "Year" with "2015", and "Configuration" with "Mondeo". At the bottom right, there are two buttons: "CANCEL" and "SAVE".

Figure 4.8

**Cancel:** Cancel editing and return to the vehicle information confirmation interface.

**Confirm Configuration:** Confirm that the configuration has been modified and return to the vehicle information confirmation interface.

**Unit Settings**

This function is used to modify the units of toe-in, angles, car height, track width and wheelbase, etc.

The screenshot shows a dialog box titled "Unit settings". It has three sections: "Toe-in unit" with radio buttons for "Degree" (selected), "Degree and minute", "mm (Tire Outside Diameter 400 mm)", and "inch(decimal inches) (Tire Outside Diameter 12 inch)"; "Angles (camber, caster, thrust angle...)" with radio buttons for "Degree" (selected) and "Degree and minute"; and "Car height" with radio buttons for "inch(decimal inches)", "1/8 in.", "1/16 in.", and "1/32 in.". At the bottom are "Cancel" and "OK" buttons.

Figure 4.9



<b>Reselect</b>	Select a vehicle again according to <b>Region -&gt; Brand -&gt; Model -&gt; Year -&gt; Configuration.</b>
<b>Confirm car</b>	Confirm vehicle information and enter the vehicle inspection interface.

### 4.2.2 Vehicle Inspection

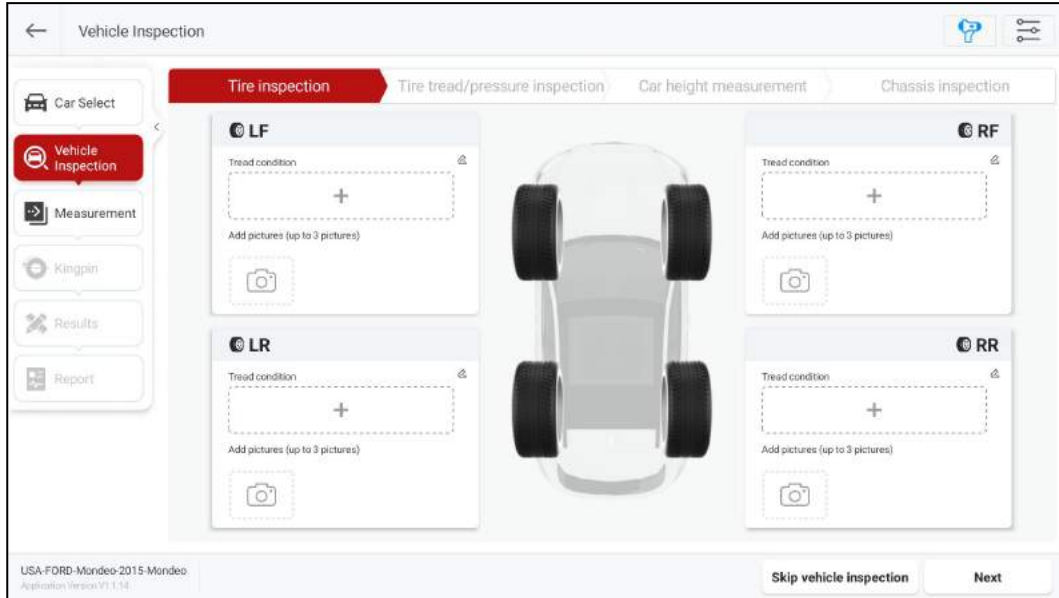

Figure 4.10

Complete vehicle tire inspection, tread and tire pressure inspection, vehicle height measurement, and chassis inspection, and enter relevant inspection information, then click **Next** to enter the **Measurement** interface. You can click on **Skip vehicle inspection** and enter the **Measurement** interface without the need for a vehicle inspection.

#### 4.2.2.1 Tire Inspection

After checking the tire condition, click the “+” button, select the tread condition option for each tire in the pop-up window, and attach the corresponding reference photos (up to 3). After completing the tire inspection, click on **Next** to enter the “**Tire tread/pressure inspection**” interface.

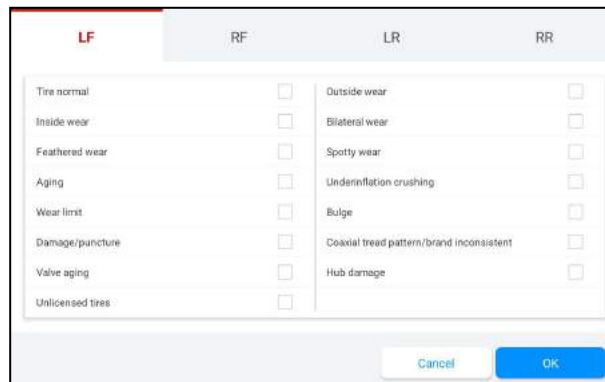

Figure 4.11

#### 4.2.2.2 Tire tread and pressure inspection

After completing the tread and tire pressure inspection, click on the corresponding input box on this interface to enter the detection value. Under the **Tread Depth** option, you can click on the “+” or “-” to increase or decrease the input box to correspond to the number of grooves for different types of tires (2 to 5).

Here, you can click **Connect tread detection tool** to connect to the corresponding tire tread depth examiner (purchased separately) for tread detection.

After completing the tread and tire pressure inspection, click **Next** to enter the **Car height measurement** interface.

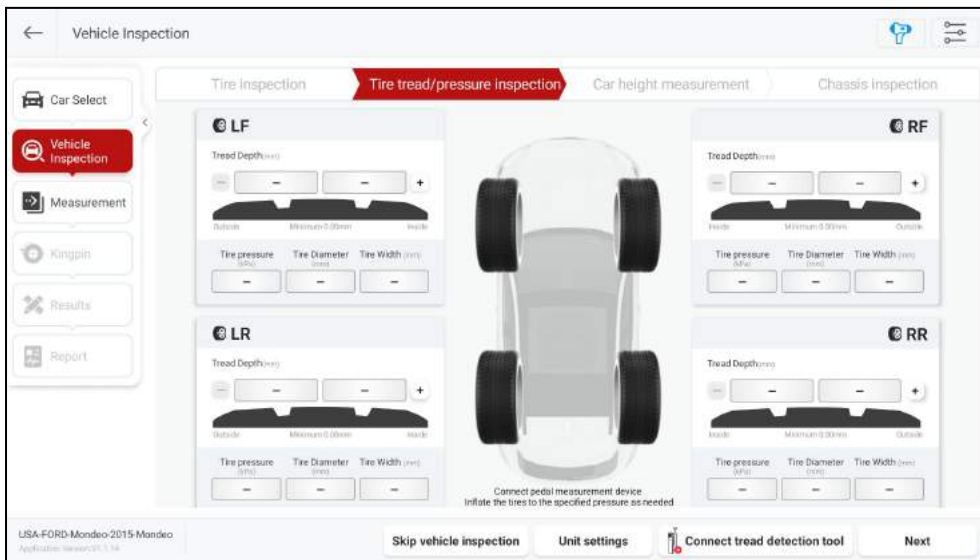

Figure 4.12

#### 4.2.2.3 Car Height Measurement

Follow the on-screen prompts to check the height of the vehicle body and enter the measurement value in the corresponding input box. The specific steps are as follows:

- 1) Fill up the vehicle with fuel, coolant, and lubricants. Place the spare tire and tools in their designated locations.
- 2) Use a tape measure to measure the vehicle height H (from the wheel arch edge to the wheel center, with or without wheel arch edge kit in the same position), and enter the value into the corresponding input box.
- 3) At this point, the front axle vehicle height H should be within the range of 376~396 mm, and the rear axle vehicle height H should be within the range of 374~394 mm. All values should be in green. Otherwise, please inspect the vehicle.

After completing the body height measurement, click **Next** to enter the **Chassis inspection** interface.

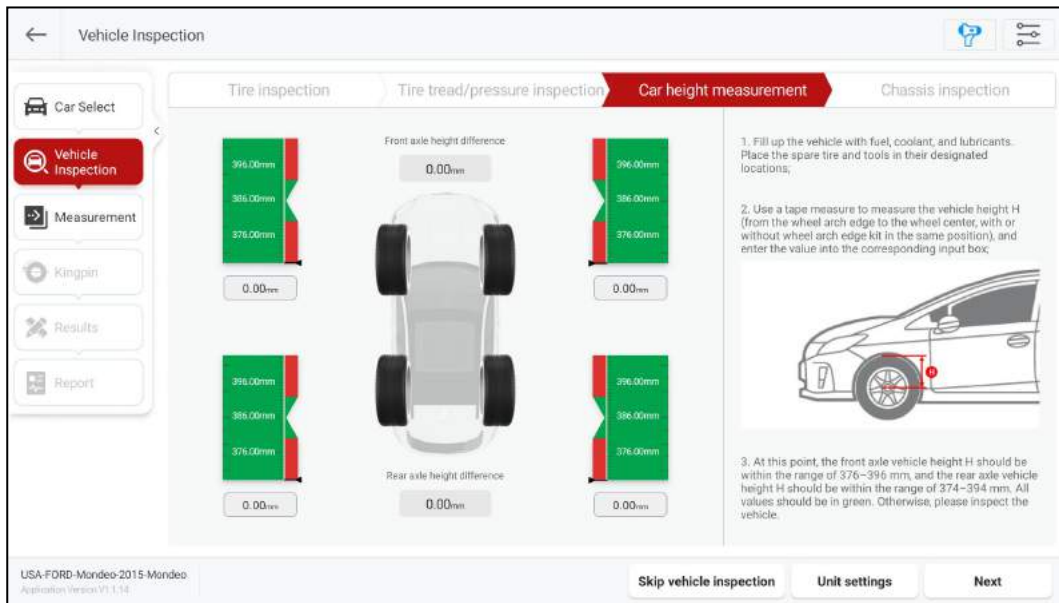

Figure 4.13

### 4.2.2.4 Chassis Inspection

Inspect the vehicle chassis according to the on-screen prompts and add relevant pictures (up to 5) and notes. Select the corresponding options to indicate the status of each component (Normal/Warning/Repair). After completing the chassis inspection, click **Next** to enter the **Measurement** interface.

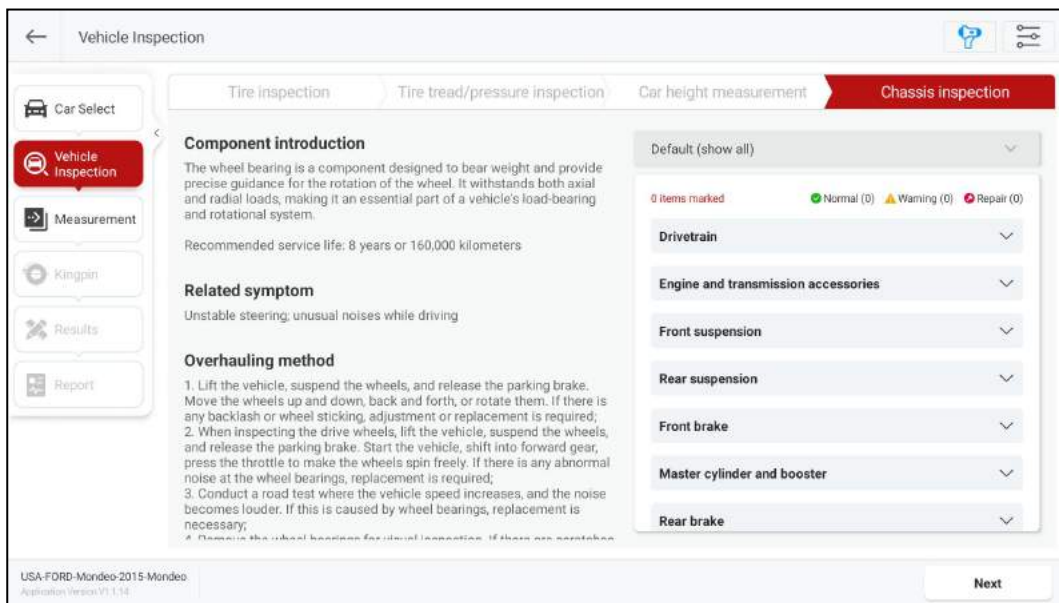

Figure 4.14

### 4.2.3 Measurement

Follow the on-screen instructions for fixture installation and device installation, then proceed with measurement scanning.

### 4.2.3.1 Fixture Installation

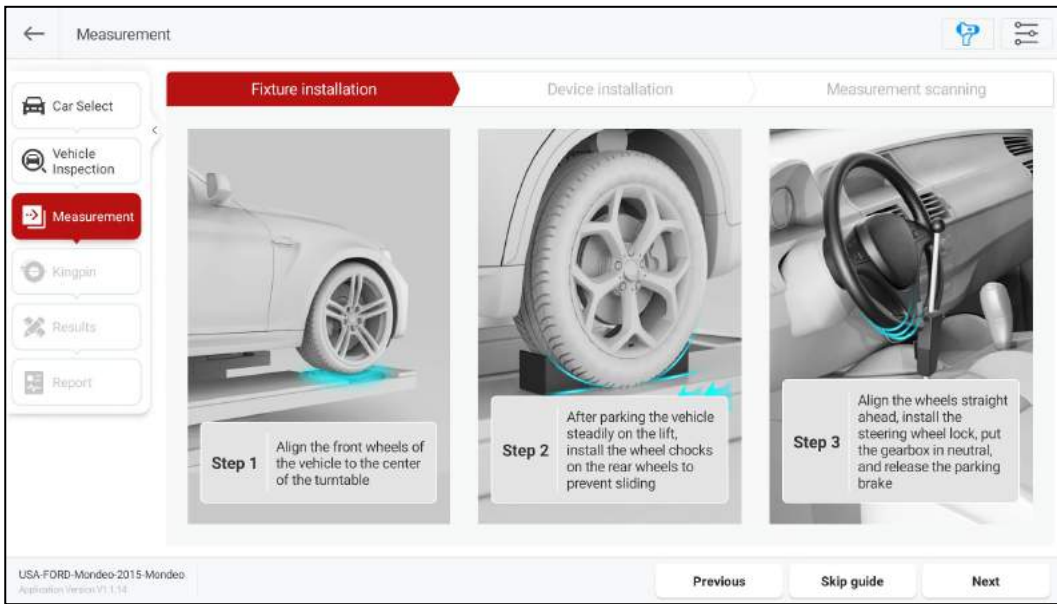

Figure 4.15

Click **Fixture installation** and install the relevant fixtures according to the on-screen instructions.

- 1) Align the front wheels of the vehicle to the center of the turntable.
- 2) After parking the vehicle steadily on the lift, install the wheel chocks on the rear wheels to prevent sliding.
- 3) Align the wheels straight ahead, install the steering wheel lock, put the gearbox in neutral, and release the parking brake.

### 4.2.3.2 Device installation

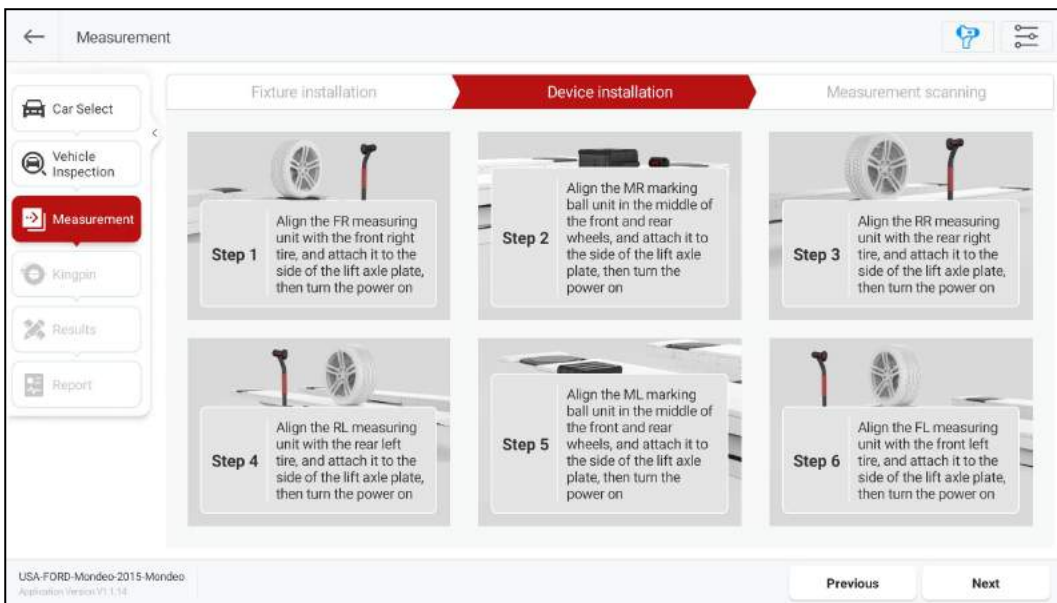

Figure 4.16

After the fixture installation is completed, click **Next** to enter the device installation guide interface, and install the relevant device according to the on-screen instructions.

*Note: It is recommended to install the matched positioning sticker on the side of the lift axle plate in advance to assist with the installation of the equipment.*

- 1) Align the FR measuring unit with the front right tire of the vehicle, with the upper edge of the magnetic suction head aligned with the positioning sticker on the side of the lift axle plate, and turn the power on after magnetically attaching it to the side of the lift axle plate.

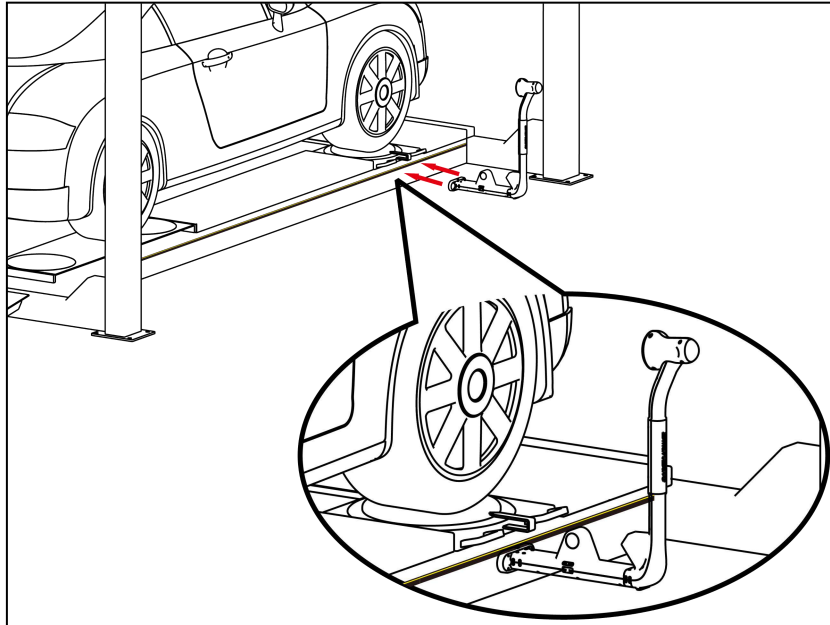

Figure 4.17

- 2) Using the same method, align the MR calibration unit with the middle of the front and rear wheels and attach it to the side of the lift axle plate before turning the power on.
- 3) Using the same method, align the RR measuring unit with the rear right tire and attach it to the side of the lift axle plate before turning the power on.
- 4) Using the same method, align the RL measuring unit with the rear left tire and attach it to the side of the lift axle plate before turning the power on.
- 5) Using the same method, align the ML calibration unit with the middle of the front and rear wheels and attach it to the side of the lift axle plate before turning the power on.
- 6) Using the same method, align the FL measuring unit with the front left tire and attach it to the side of the lift axle plate before turning the power on.

After the measuring units and the calibration units are installed, the indicator lights on the lampshade will flash rapidly in green. At this point, it means that the measuring units and the calibration units are searching for the detection tablet. Afterwards, the indicator lights will flash slowly in green, indicating that the equipment is networking internally.

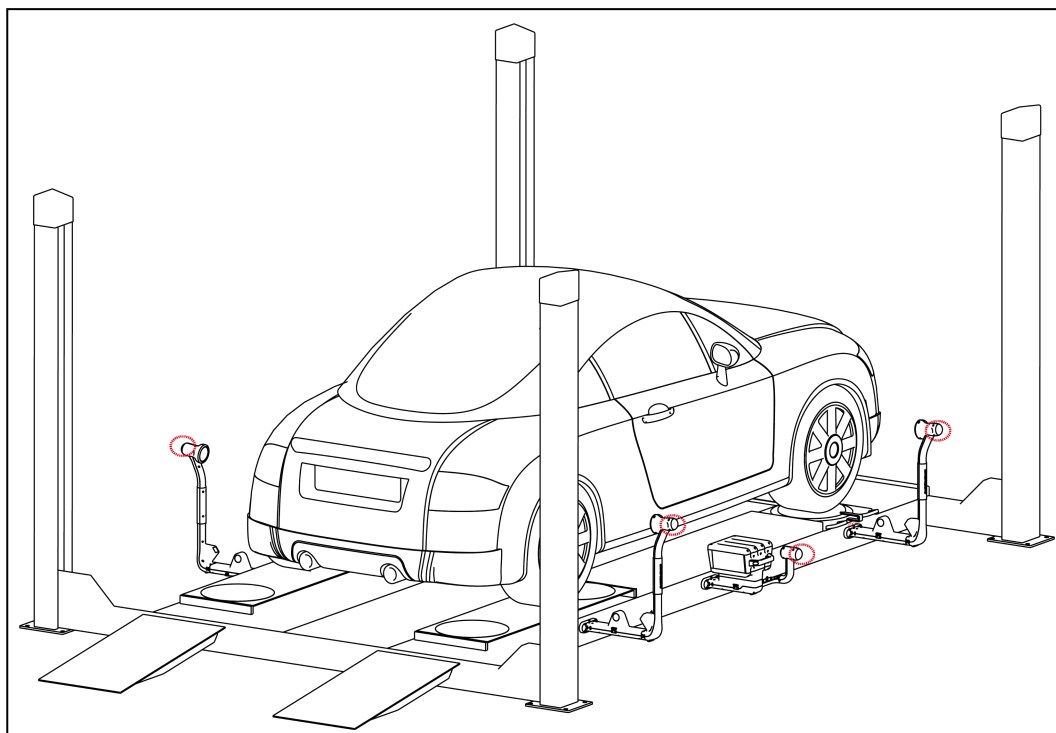

Figure 4.18

### 4.2.3.3 Measurement Scanning

After the equipment is installed, click **Next** to enter the measurement scanning interface.

Confirm all measuring units and calibration unit icons display **Connected** before clicking **Start Calibration**.

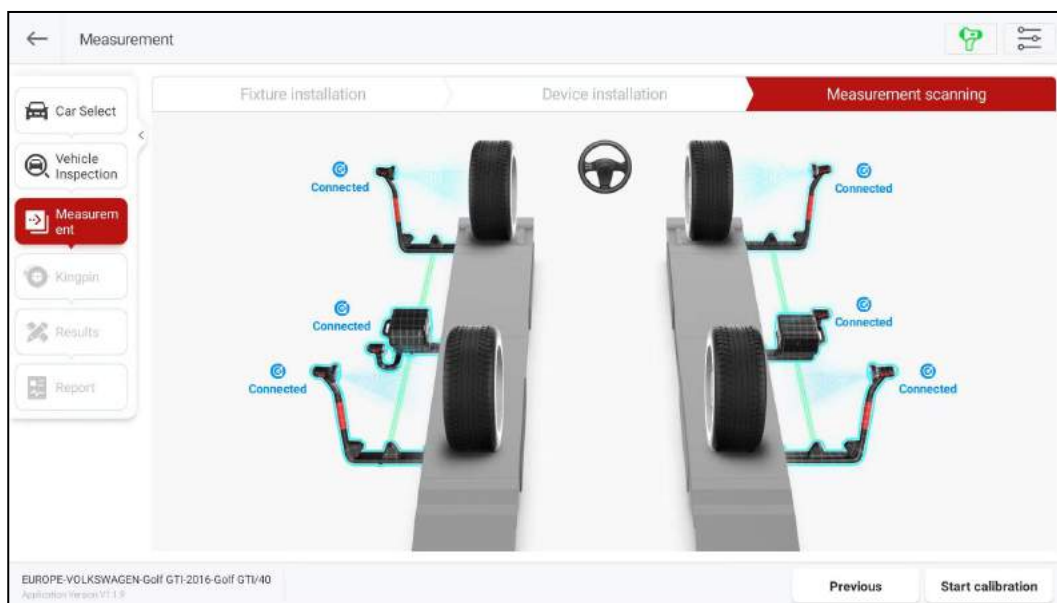

Figure 4.19

After completing the calibration, the measuring unit and calibration unit icons will display **Ready**.



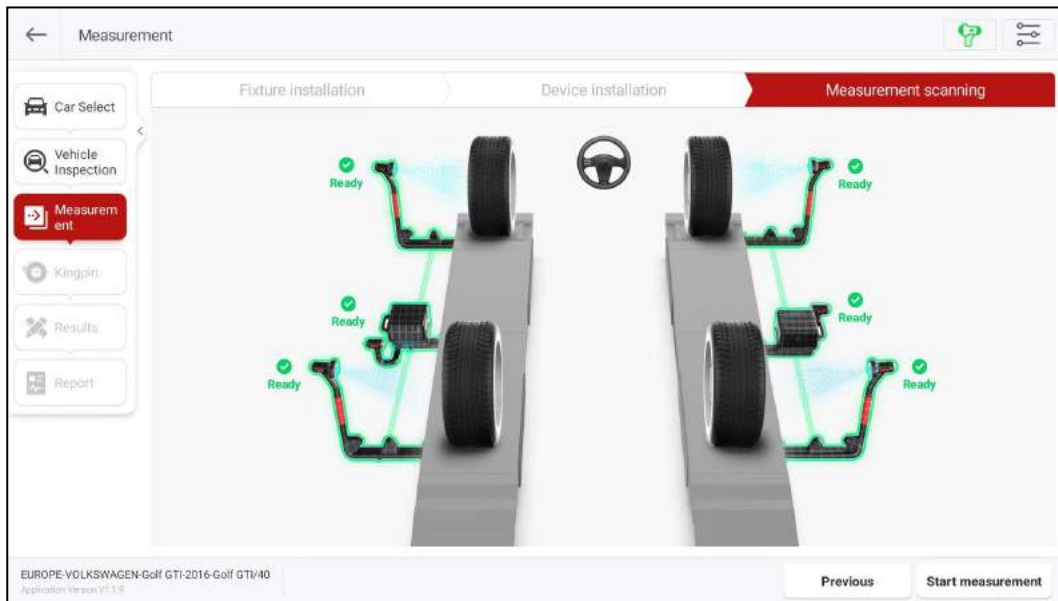

Figure 4.20

After the equipment calibration is completed, click on **Start measurement** to perform inclination measurement. After the inclination measurement is completed, switch to the Kingpin Measurement interface.

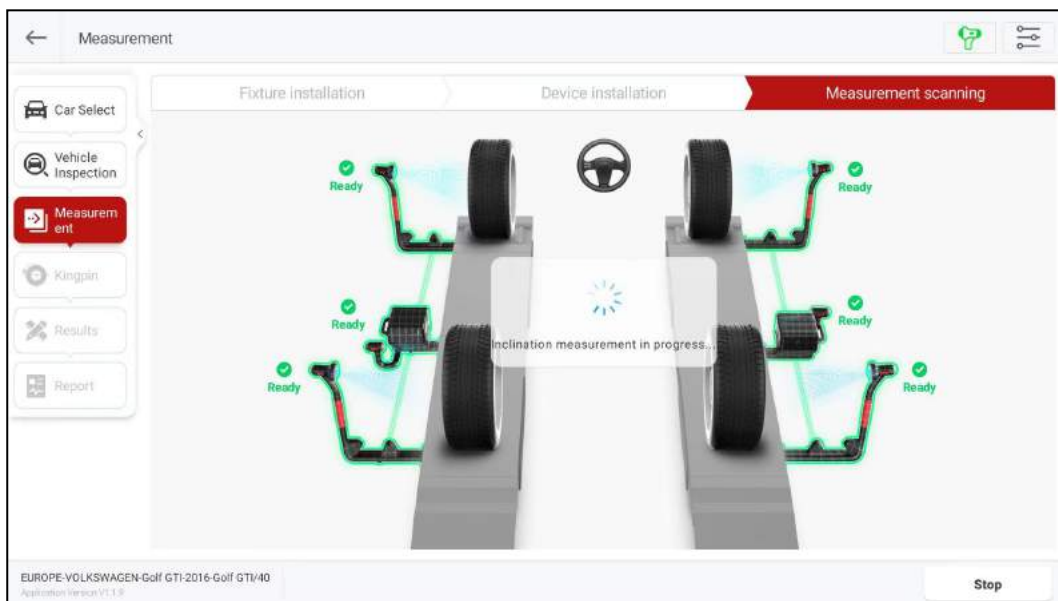

Figure 4.21

#### 4.2.4 Kingpin Measurement

Kingpin measurement is specific to front wheels, including kingpin inclination and caster. The kingpin inclination angle can distribute the vehicle weight evenly on the bearings, protecting them from damage and making the steering force uniform and steering light. The presence of a caster angle can make the intersection point of the steering axis and the road surface in front of the tire touchdown point, which can use the resistance of the road surface to keep the car moving straight.

### 4.2.4.1 Measurement Preparations

Prepare the following according to the on-screen prompts:

- 1) Install the brake lock.
- 2) Remove the steeling wheel pin.
- 3) Remove the side-slip plate pin.

After the preparation is completed, click [Next] to enter the "Kingpin Measurement" interface.

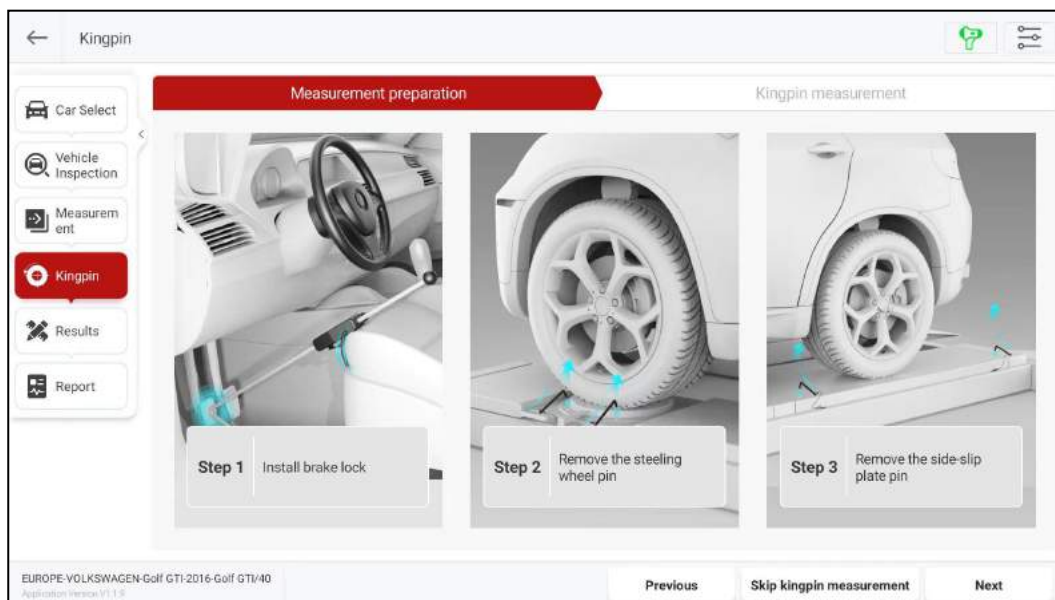

Figure 4.22

### 4.2.4.2 Kingpin

- 1) Adjust the steering wheel to the straight-ahead position, that is, when the two front wheels have equal toe-in angles, the indicator on the operating interface will move to the middle position.

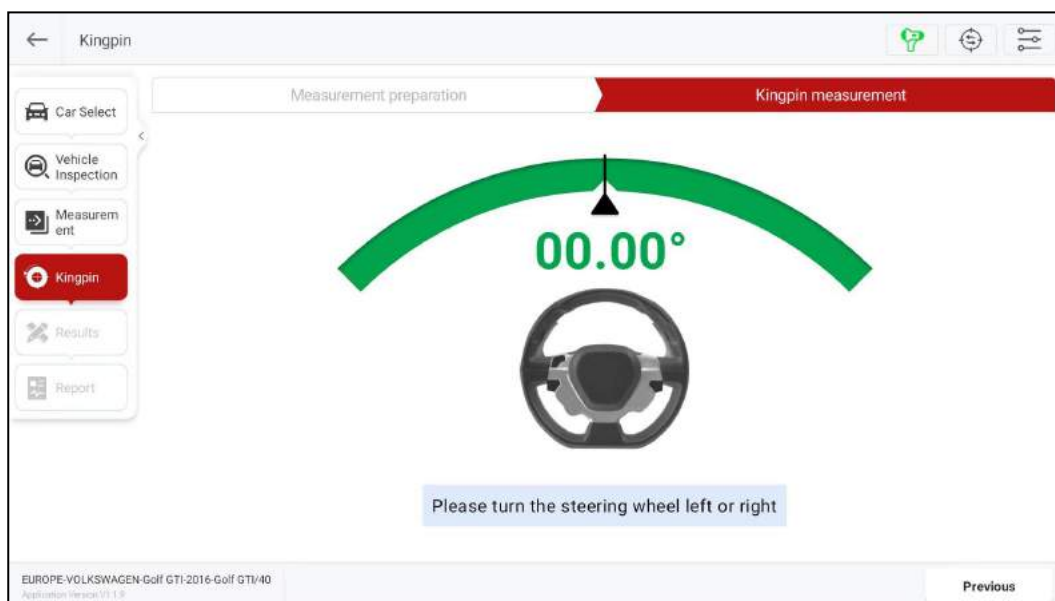

Figure 4.23

- 2) Follow the system prompt and turn the steering wheel to the left or right (turning it steadily and



gradually). When the wheel angle reaches or exceeds the set angle (12 degrees), the system will prompt you to turn the steering wheel in the opposite direction.



Figure 4.24

- 3) Follow the on-screen prompt to steadily and gradually turn the steering wheel. When the wheel angle reaches or exceeds the set angle (12 degrees), the system will prompt you to return the steering wheel to the initial position.



Figure 4.25

- 4) Follow the system prompt to return the steering wheel to its initial position. The information collection is complete.

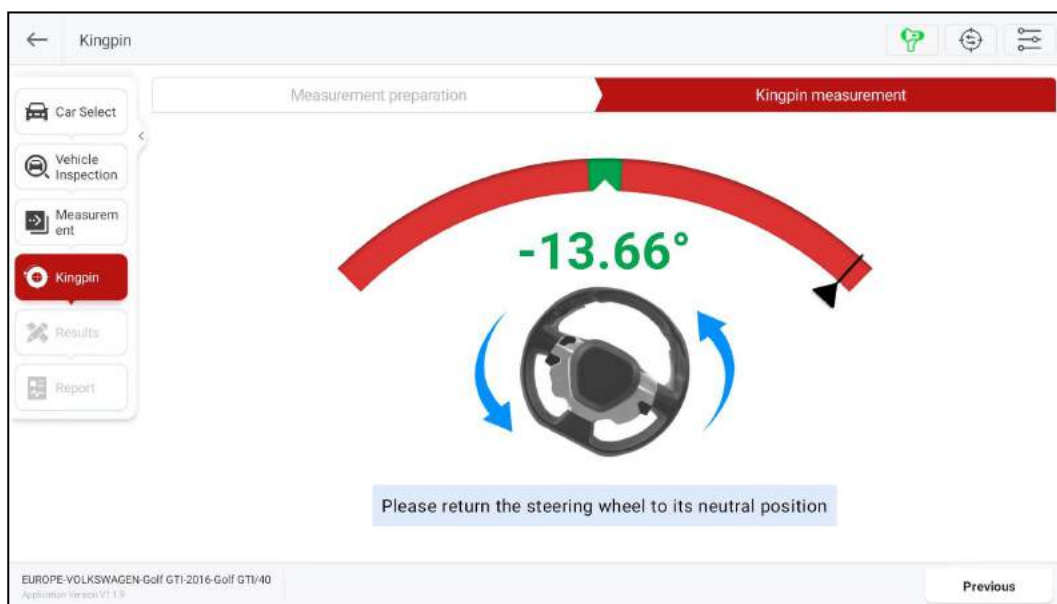

Figure 4.26

After the kingpin measurement is completed, switch to the **Results** interface.

*Note: If the lift shakes or is lifting a vehicle, please click the button to perform global calibration.*

### 4.2.5 Results

This function is used to view and save measurement results. The displayed by default are the "Global" measurement results. To view the separate measurement results for **Rear Axle**, **Front Axle**, **Symmetry**, and other items, simply click on the corresponding buttons at the top of the screen.

Click **Unit Settings** to modify the display unit of the measurement item.

Before maintenance, please click **Save the current value as before repair**. The measurement results will be updated in real-time after the maintenance is completed. Click **Next** to save the current measurement results and enter the **Report** interface.



Figure 4.27

### 4.2.6 Report

This function is used to view, save, and share detection reports. On the right side of the screen, you can click to view the four-wheel alignment, before and after maintenance, before maintenance, current value, symmetrical value, chassis inspection, tire inspection, and body height inspection reports.

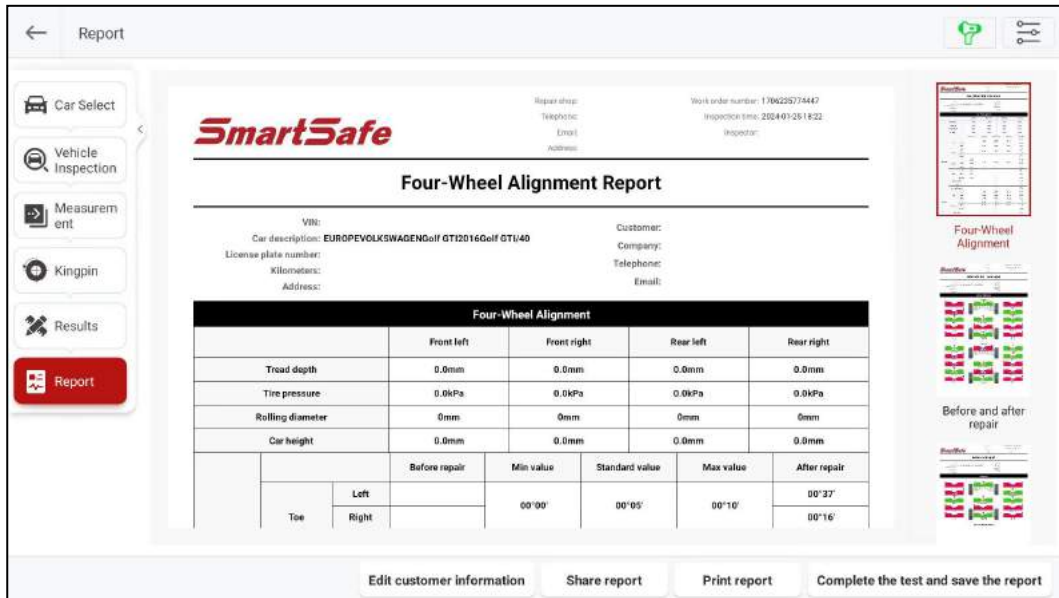

Figure 4.28

Click **Edit customer information** to modify or add customer information.

**Customer Information**

<p><b>Car info</b></p> <p>License plate number <input type="text"/></p> <p>VIN <input type="text"/></p> <p>Year 2016</p> <p>Manufacturer VOLKSWAGEN</p> <p>Model Golf GTI</p> <p>Kilometers <input type="text"/></p>	<p><b>Personal information</b></p> <p>Name <input type="text"/></p> <p>Landline number <input type="text"/></p> <p>Mobile number <input type="text"/></p> <p>Email <input type="text"/></p> <p>Company <input type="text"/></p> <p>Address <input type="text"/></p>
----------------------------------------------------------------------------------------------------------------------------------------------------------------------------------------------------------------------------------------------	---------------------------------------------------------------------------------------------------------------------------------------------------------------------------------------------------------------------------------------------------------------------------------------------

Figure 4.29

Click **Share report** to share the detection report via QR code or Email.

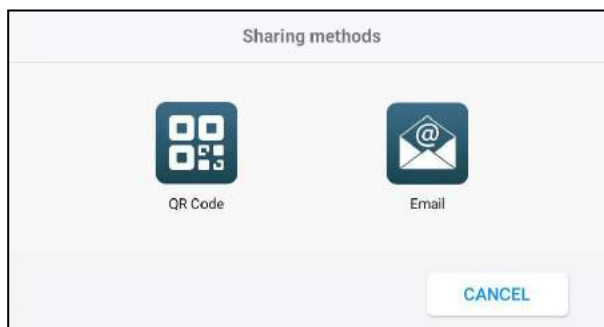

Figure 4.30

Click **Print report** to print the current detection report or save the report as a PDF document.

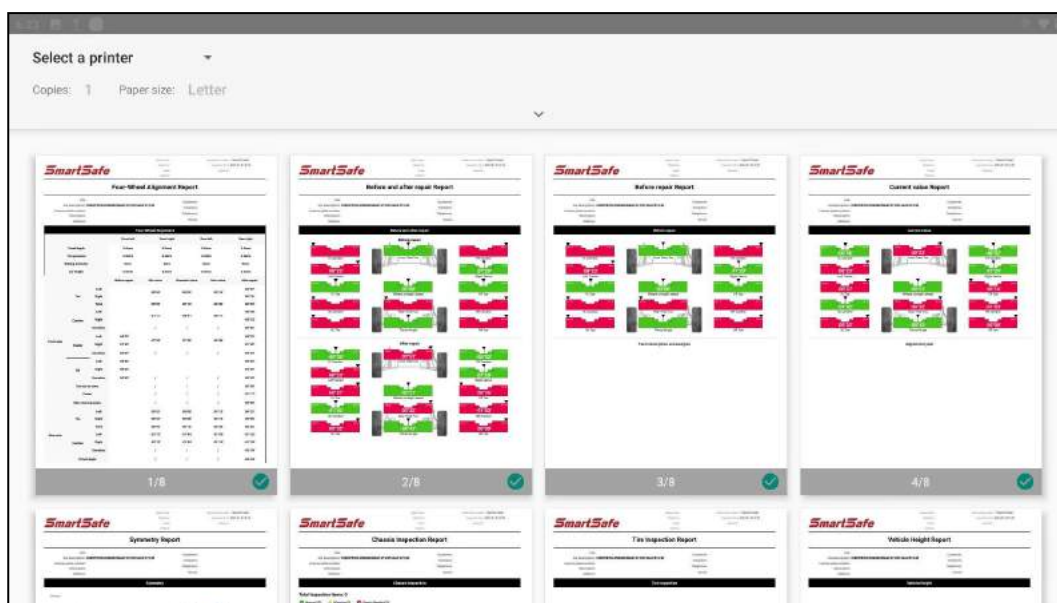

Figure 4.31

Click **Complete the test and save the report** to save the detection report on the tablet. You can click **Inspection Records** on the main interface to query and manage all saved reports.

### 4.3 Quick Inspection

Quick inspection does not include vehicle selection and vehicle inspection steps, does not perform kingpin measurement, if you need to operate all measurement functions, please select **Four-wheel Alignment** for routine inspection.

#### 4.3.1 Measurement

Click on **Quick Inspection** on the main interface to enter the following screen:

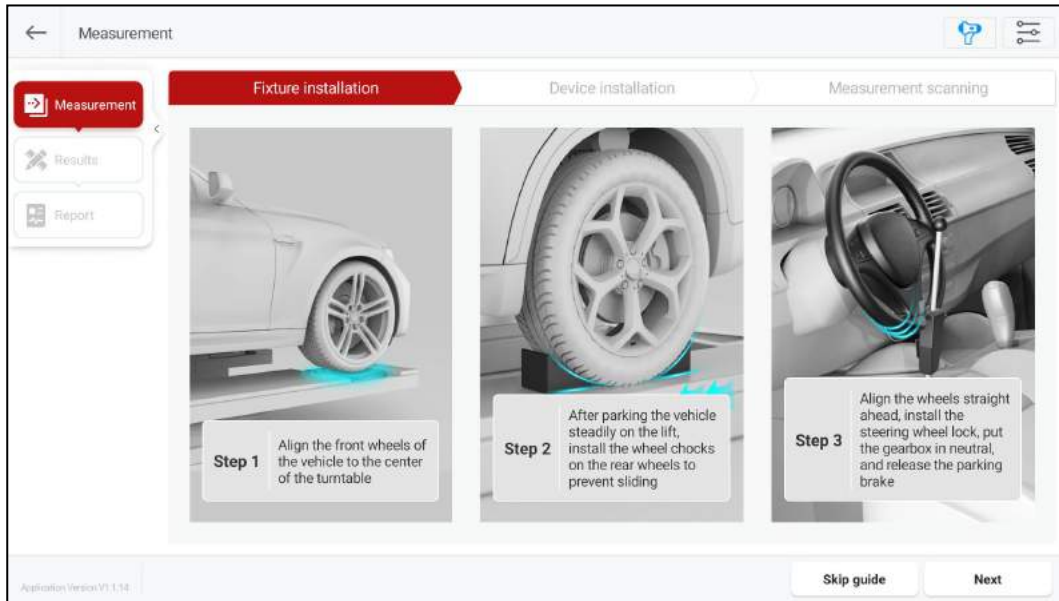

Figure 4.32

Follow the on-screen instructions to complete the steps of fixture installation, device installation, measurement scanning, etc. After completing the inclination measurement, go to the **Results** interface.

### 4.3.2 Results

This function is used to view and save measurement results. The displayed by default are the global measurement results. To view the separate measurement results for Rear Axle, Front Axle, Symmetry, and other items, simply click on the corresponding buttons at the top of the screen.



Figure 4.33

Save the measurement results before maintenance. The measurement results will be updated in real time after the maintenance is completed. Click **Next** to save the current measurement results and enter the **Report** interface.

### 4.3.3 Report

This function is used to view, save, and share detection reports. On the right side of the screen, you can click to view the inspection reports for four-wheel alignment, before and after maintenance, before maintenance, current value, symmetrical value, etc.

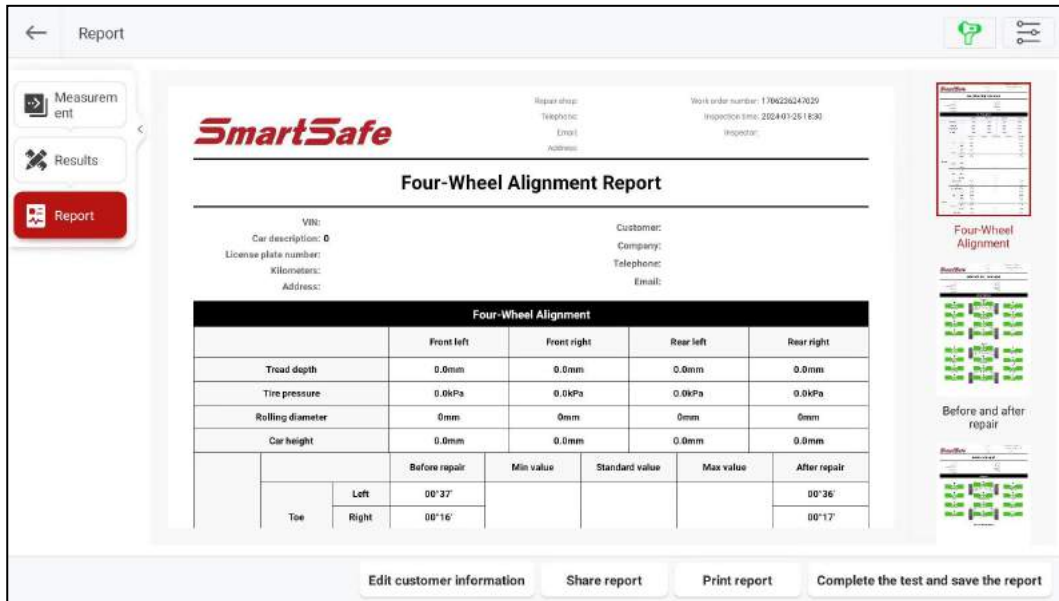

Figure 4.34

Screen button instructions are as follows:

<b>Edit customer information</b>	Modify or add customer information.
<b>Share report</b>	The detection report can be shared via email.
<b>Print report</b>	Print the current detection report or save the report as a PDF document.
<b>Complete the test and save the report</b>	Save the detection report on the detection tablet, and you can click <b>Inspection Records</b> on the main interface to query and manage all saved detection reports.

### 4.4 Inspection Records

This function is used to view and manage saved detection reports.

Click on the **Inspection Records** on the main interface to enter the inspection records interface. The inspection records are classified according to the detection time. Click on the downward/upward arrow on the right side of the corresponding time to expand/collapse the record list.

In the search box at the top of the screen, you can enter keywords of the report name to quickly search and find the corresponding detection report.



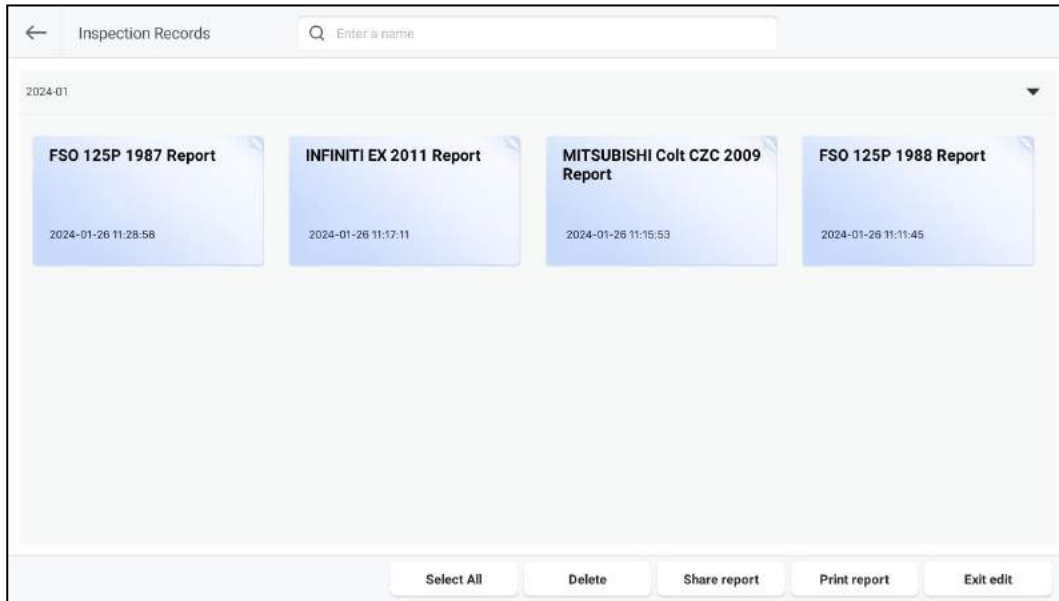

Figure 4.35

Clicking on a single record allows you to view the details of the inspection report, and you can also share and print the inspection report.

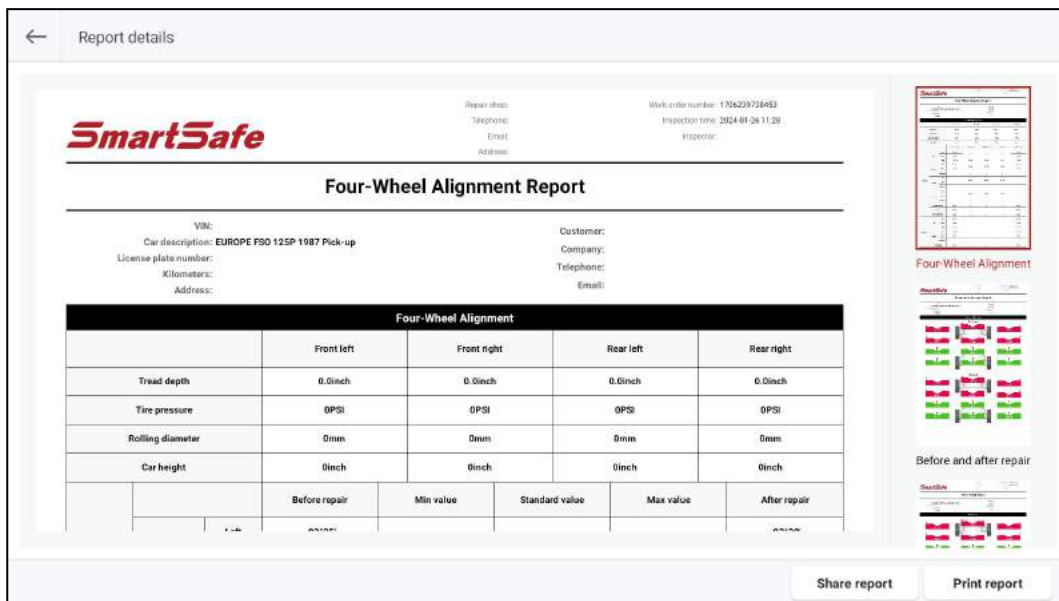

Figure 4.36

Click **Edit** to manage the detection report.

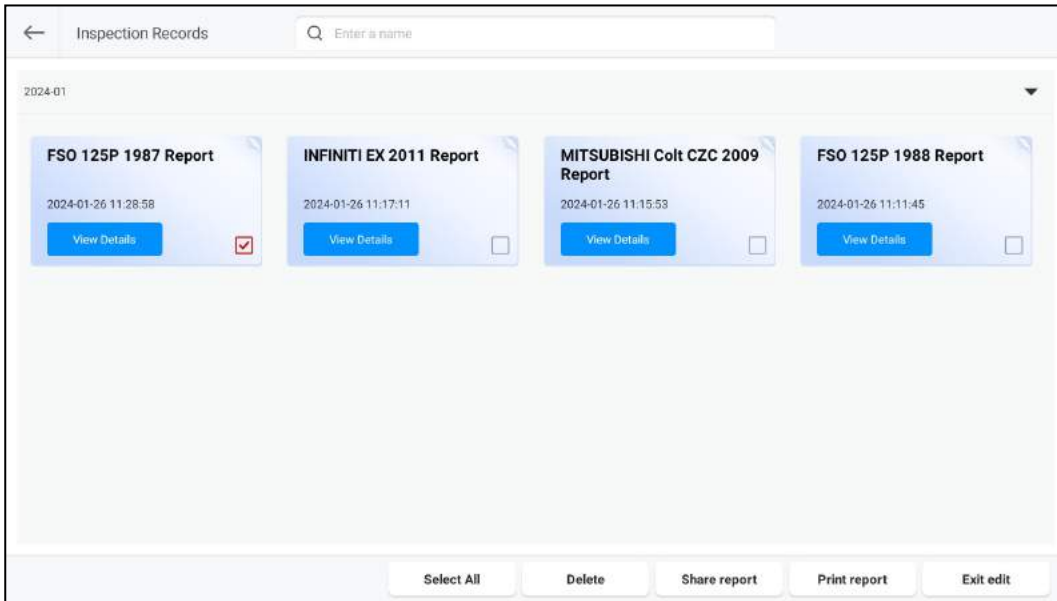

Figure 4.37

Screen button instructions are as follows:

<b>View Details</b>	View the details of this detection report.
<b>Select All</b>	Select all expanded detection reports.
<b>Delete</b>	Delete the selected detection report.
<b>Share Report</b>	Share the selected detection report, only one report can be shared at a time.
<b>Print Report</b>	Print the selected detection report, only one report can be printed at a time.
<b>Exit Edit</b>	Exit edit mode.

## 4.5 Database

This function includes standard database and custom database. Standard database includes information about various series of products produced by numerous manufacturers both domestically and internationally during their production period, and it can update the content in the database in a timely manner through system upgrades.

### 4.5.1 Standard Database

Click **Database** on the main interface, then select **Standard Database**.





Figure 4.38

In the standard database, select the vehicle by **Region -> Brand -> Model -> Year -> Configuration** (you can quickly search by entering the corresponding keywords in the search box at the top of the screen) and enter the **Car info** interface to view the corresponding vehicle's parameter information.

Click **Upgrade** at the bottom of the screen to upgrade the standard database to the latest version.

*Note: After the database upgrade, the original custom data will not be lost.*

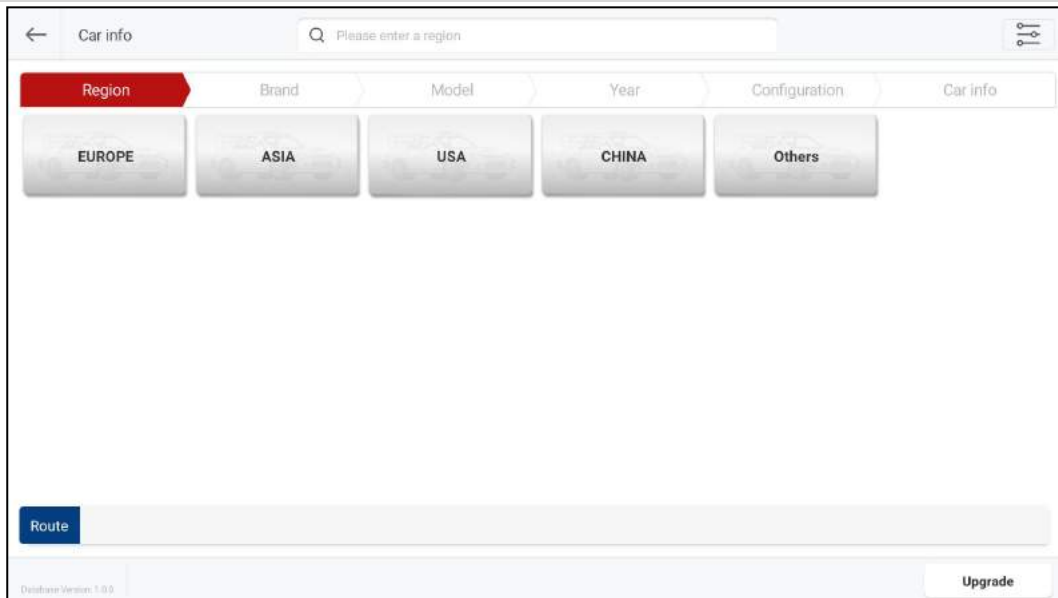

Figure 4.39

In the **Car info** interface, you can click on **Unit settings** to modify the value display unit for the corresponding parameters.

Front axle		Rear axle	
Parameter	Min	Standard	Max
Front Total Toe	-00.13°	00.00°	00.13°
FL Toe	-00.06°	00.00°	00.06°
FR Toe	-00.06°	00.00°	00.06°
FL Camber	-01.93°	-00.65°	00.63°
FR Camber	-01.93°	-00.65°	00.63°
Left Caster	01.56°	02.59°	03.62°
Right Caster	01.56°	02.59°	03.62°

Figure 4.40

Figure 4.41

Click **Modify configuration** to modify the corresponding parameter values as needed, then click **Save**. In the pop-up dialog box, enter the configuration name and click **OK** to save the modified configuration as a custom configuration.

Front axle		Rear axle	
Parameter	Min	Standard	Max
Front Total Toe	-00.13°	00.00°	00.13°
FL Toe	-00.06°	00.00°	00.06°
FR Toe	-00.06°	00.00°	00.06°
FL Camber	-01.93°	-00.65°	00.63°
FR Camber	-01.93°	-00.65°	00.63°
Left Caster	01.56°	02.59°	03.62°
Right Caster	01.56°	02.59°	03.62°

USA-FORD-Mondeo-2015-Mondeo  
Database Version: 1.0.0

Save Cancel Car info editor Unit settings

Figure 4.42

Save Configuration

Enter the configuration name:

CANCEL OK

Figure 4.43

### 4.5.2 Custom Database

In addition to the standard database provided by the system, users can also add custom data to manually add vehicle model information that is not available in the standard data, making the system more suitable for maintenance station applications.

Enter the **Custom database** management interface through **Database -> Custom Database** on the main interface.

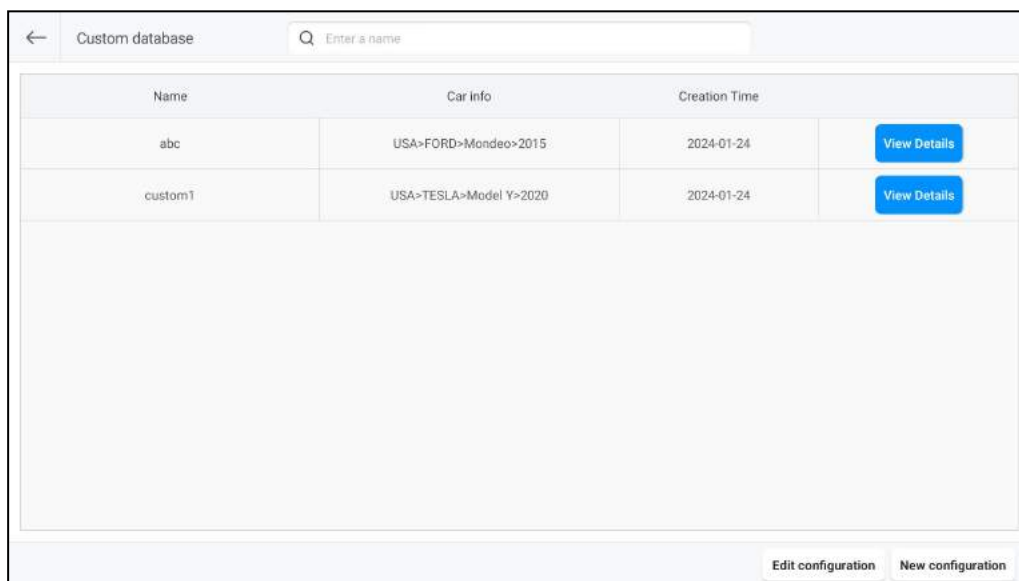

Figure 4.44

Screen button instructions are as follows:

<b>View Details</b>	View the details of this custom data.
<b>Edit configuration</b>	Used to select and delete single or multiple custom data.
<b>New configuration</b>	Used to add new custom data.

## 4.6 Device Management

This function is used to view device status and version information, manage device systems, and firmware upgrades.

Click on **Device Management** on the main interface to enter the following interface:

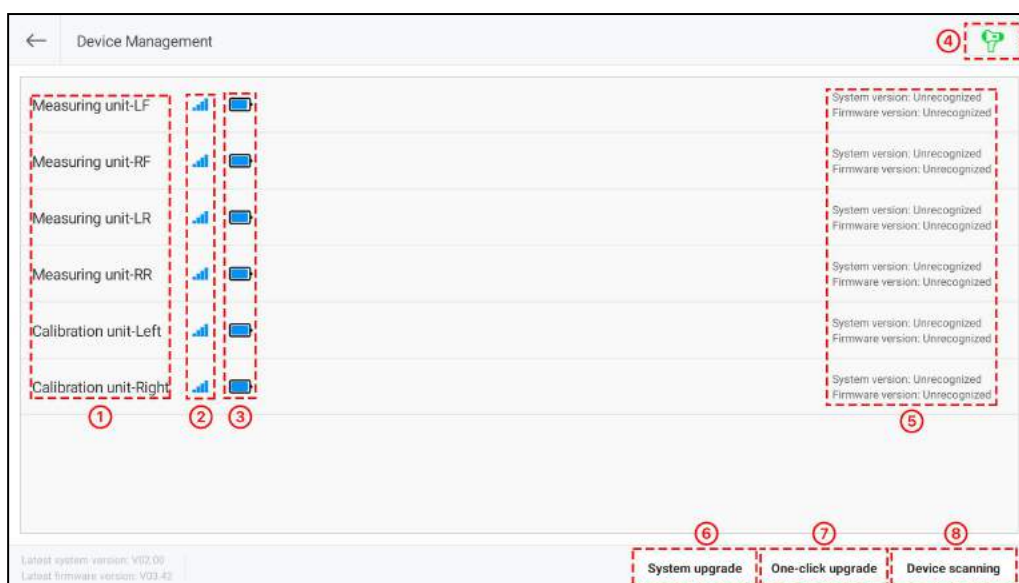





Figure 4.45

Screen buttons and display item descriptions are as follows:

① <b>Equipment name and identification</b>	Used to identify and distinguish different equipment.
② <b>Connection status</b>	When the equipment is not connected to the Internet, the icon is displayed in gray. After the equipment is connected to the Internet, the icon turns blue and displays the network signal strength.
③ <b>Battery status</b>	When the equipment is not connected to the Internet, the icon is displayed as  . After the equipment is connected to the Internet, the icon changes to  . (If the battery level is below 30%, the icon will be displayed in orange  ).
④ 	Used to view system and firmware version information.
⑤ <b>System version and firmware version</b>	Used to display the system version and firmware version information.
⑥ <b>System upgrade</b>	Upgrade the system to the latest version.
⑦ <b>One-click upgrade</b>	Used for one click upgrade of device firmware to the latest version. <i>Notes:</i> <ul style="list-style-type: none"> <li>• When upgrading, please set the power switches of the 4 measuring units and 2 calibration units to "ON".</li> <li>• Please make sure that the battery level of each individual unit is above 80% or place the equipment on the charging base to charge.</li> </ul>
⑧ <b>Device scanning</b>	Used to scan and connect the equipment for networking.

## 4.7 System Settings

This function is used to perform parameter settings, manage customer and shop information, switch system language, view application version and serial number, and other information.

### 4.7.1 Parameter Settings

Click on **System Settings** on the main interface to enter the **Parameter Settings** page. Users can switch between different display units for toe-in, angles, track width and wheelbase, tread depth, tire pressure, and car height as needed.

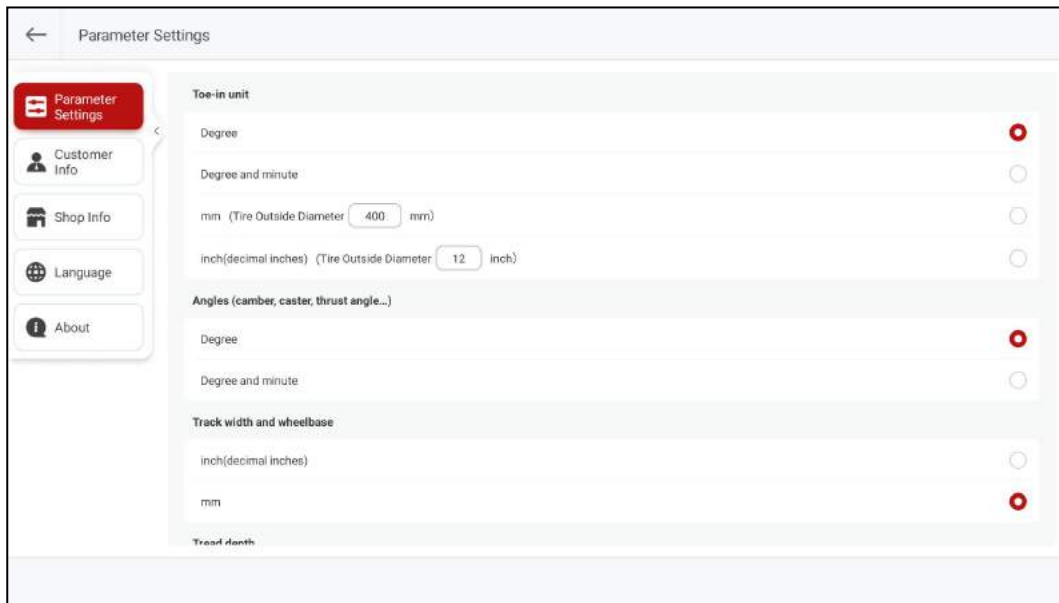

Figure 4.46

### 4.7.2 Customer Information

Click **Customer Info** on the left side of the screen to enter the customer information management interface.

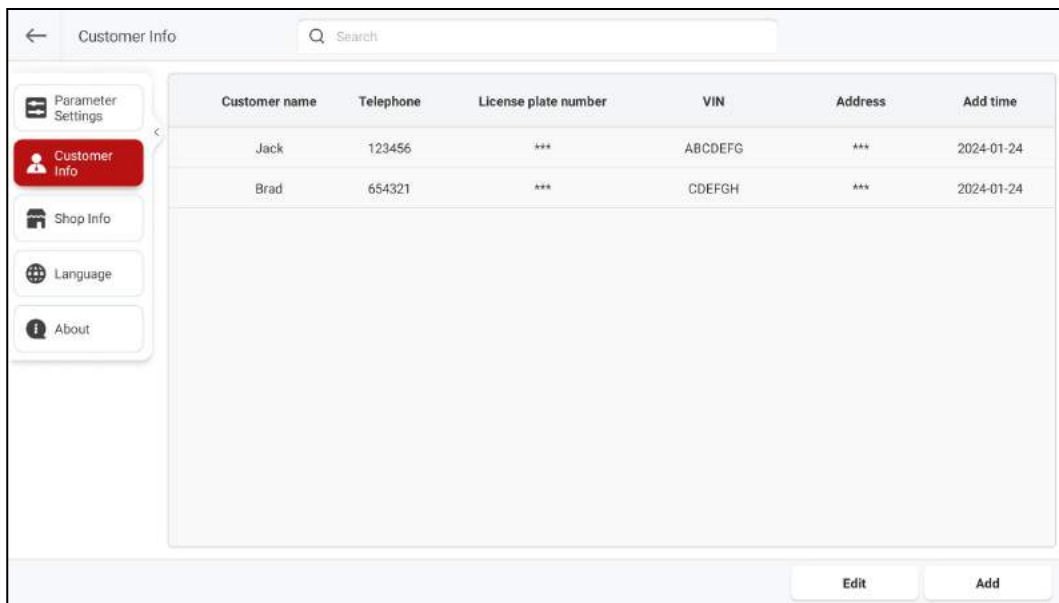

Figure 4.47

Click on a single customer information, edit the corresponding information in the pop-up window, and click **Save** to modify the customer information.

Modify customer info

Customer name  
Jack

Telephone  
123456

License plate number  
\*\*\*

VIN  
ABCDEFG

Address  
\*\*\*

Cancel Save

Figure 4.48

Click **Edit**, then select the checkbox in front of the customer information and click **Delete**, click **OK** in the pop-up dialog to delete the selected customer information.

Customer Info

Customer name	Telephone	License plate number	VIN	Address	Add time
<input checked="" type="checkbox"/> Jack	123456	***	ABCDEFG	***	2024-01-24
<input type="checkbox"/> Brad	654321	***	CDEFGH	***	2024-01-24

Parameter Settings  
Customer Info  
Shop Info  
Language  
About

Select all Delete Exit editing Add

Figure 4.49

Hint

Are you sure you want to delete?

Cancel OK

Figure 4.50

After clicking on **Add**, enter the corresponding customer information in the pop-up window, and then click **Save** to add the customer information.

Figure 4.51

### 4.7.3 Shop info

Click **Shop info** on the left side of the screen to enter the shop information management interface.

Click **Edit**, then edit the corresponding store information, click **Save** to save the new shop information.

Figure 4.52

### 4.7.4 Select Language

Click **Language** on the left side of the screen to enter the language switch management interface.





Figure 4.53

Click on the language you want to switch to, and then click **OK** in the pop-up dialog to restart the application and switch to the new language.

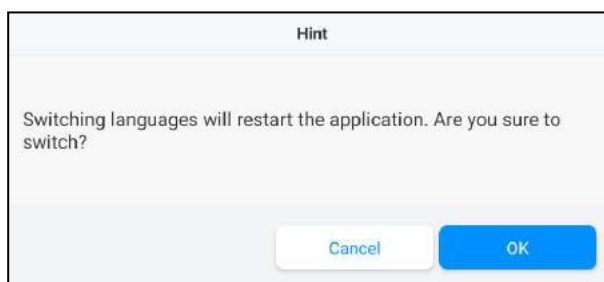

Figure 4.54

### 4.7.5 About

Click **About** on the left side of the screen to the following interface, here you can check the application version, system version, database version and device SN, and can also perform the system upgrade.

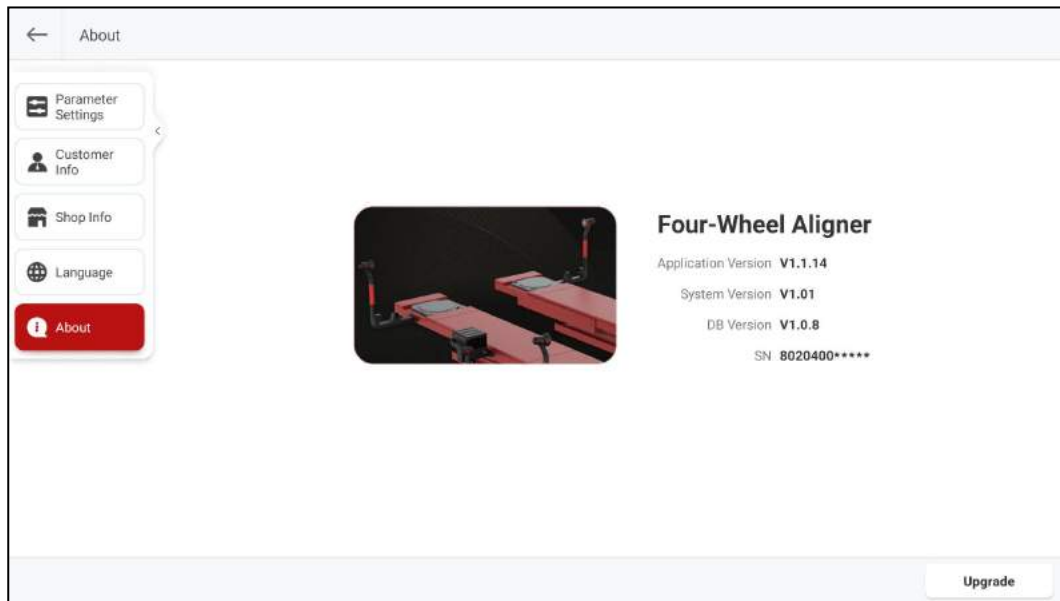

Figure 4.55

Click **Upgrade**, the system will check for new application versions and upgrade the application to the latest version.

## 4.8 Terms

Four-wheel alignment angle refers to the relative angle between the suspension system and various moving components. Maintaining the correct four-wheel alignment angle ensures the stability of the vehicle's movement and reduces tire wear.

The main angles of the four-wheel alignment of a car include: camber, toe-in, caster, and kingpin inclination.

### 4.8.1 Geometric Center Line

Longitudinal center plane of the vehicle body and the intersection of the horizontal plane passing through the front and rear axles of the vehicle.

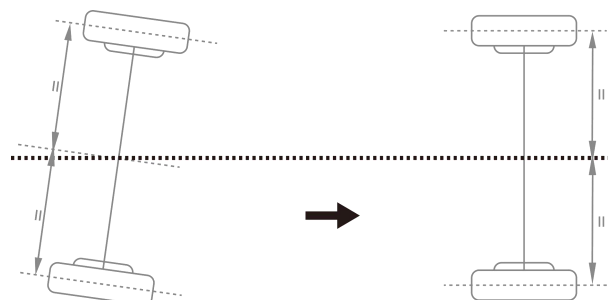

Figure 4.56

### 4.8.2 Camber

Camber is defined as an angle formed by the centerline of the tire and the vertical line as viewed from the front of the car, which is **positive when outward and negative when inward**, as shown in Figure

4.57. The different angles can change the contact point and force point between the tire and the ground, directly affecting the tire's grip and wear condition, and changing the distribution of weight on the axle, avoiding abnormal wear of the bearings. In addition, the existence of the camber can be used to counteract the angular changes caused by the deformation of the suspension system components and the clearance between the moving surfaces after the vehicle body is subjected to loads. The existence of the camber also affects the direction of travel of the car, just as motorcycles can use the inclination of the body to turn. Therefore, the camber angle of the left and right wheels must be equal, so as not to affect the straight-line stability of the car under the balance of forces, and to improve the straight-line stability and avoid uneven tire wear in coordination with the toe-in. If there is no positive camber, the wheels will incline too much towards the inside when fully loaded, thereby accelerating tire wear and wheel bearing wear. Therefore, this parameter can extend the life of tires and wheel bearings.

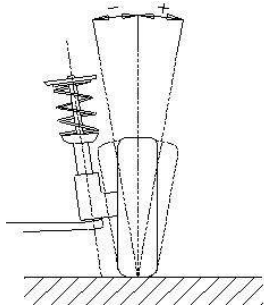

Figure 4.57

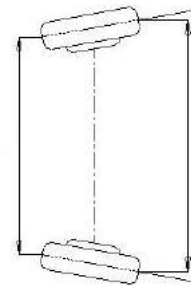

Figure 4.58

### 4.8.3 Toe-in (Angle)

Toe-in is defined as an angle formed between the centerline of the tire and the longitudinal axis of the car, as viewed downward from the top of the car, which is **positive when inward and negative when outward**, as shown in Figure 4.58. The total toe-in value is equal to the sum of the Toe-in values of the two wheels, which is the angle between the centerlines of the two tires. The function of the toe-in is to compensate for the tendency of the tire to roll inward or outward due to the camber angle and road resistance, in order to ensure the straight-line stability of the car.

The parameter associated with the toe-in is the toe-out, also defined as the angle formed by the two tires when viewed from above the vehicle. However, the symbol definition is opposite to that of the toe-in angle, **negative when inward and positive when outward**. Due to some people being accustomed to using the toe-out, special attention should be paid to the difference between the toe-in and toe-out.

### 4.8.4 Kingpin inclination

Kingpin inclination is defined as an angle formed by the centerline of the steering axis and the vertical line as viewed from the front of the vehicle, as shown in Figure 4.59. The kingpin inclination angle can distribute the vehicle weight evenly on the bearings, protecting them from damage and making the steering force uniform and steering light. On the contrary, if the kingpin inclination angle is 0, the reaction

force between the vehicle weight and the ground will generate a large lateral shear stress on the axle, which can easily damage the axle and make the steering heavy. In addition, the kingpin inclination is also the source of the steering return force of the front wheels. The kingpin inclination has been set at the beginning of the vehicle suspension design and is usually non-adjustable.

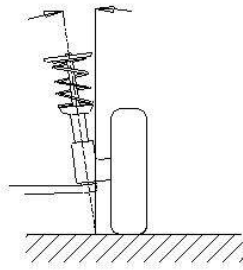

Figure 4.59

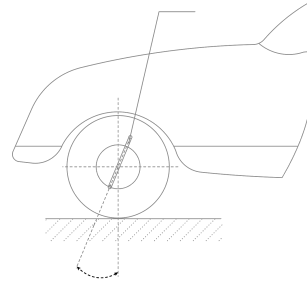

Figure 4.60

### 4.8.5 Kingpin caster

Kingpin caster is defined as an angle formed by the centerline of the steering axis and the vertical line as viewed from the side of the vehicle, which is negative when forward and positive when backward, as shown in Figure 4.60. The presence of the kingpin caster angle can make the intersection point of the steering axis and the road surface be in front of the tire contact point. The resistance of the road surface to the tire can be used to keep the car going straight. The principle is similar to the front wheel of a shopping cart automatically turning in the direction you apply force and maintaining straight movement. The larger the caster angle, the better the straight-line stability of the car and the better the steering response when turning. However, it will make the steering heavier. The kingpin caster angle of a normal car is approximately between 1~4 degrees.

### 4.8.6 Toe-out when turning 20°

Toe-out when steering is defined as the difference in steering angle between the two front wheels when turning 20°, as shown in Figure 4.61. When turning, the angle that the inner wheel turns is usually greater than the outer wheel, with a difference of about 2 degrees. The purpose is to allow the car to turn smoothly with the instantaneous center of the rear axle extension line as the center of the circle when turning. In addition, when the turning angle of the inner wheel is larger, the resistance is also larger. The difference in resistance can cause the car to lean towards the side with greater resistance, making steering easier.

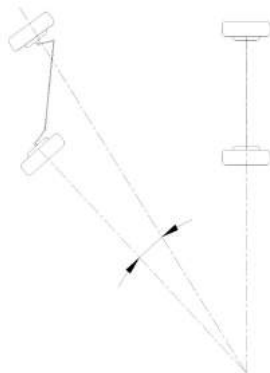

Figure 4.61

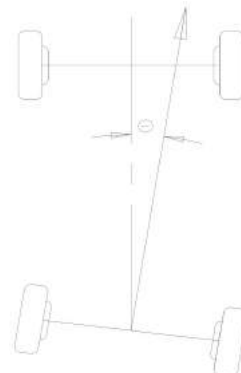

Figure 4.62

### 4.8.7 Thrust angle

Thrust angle is defined as a angle formed by the bisector (thrust line) of the total toe-in angle of the rear wheels and the geometric centerline (see Figure 4.62). It is generally specified that the value is positive when the thrust line is leftward and negative when the thrust line is rightward. If the thrust angle is not zero, the vehicle has a tendency for lateral movement. If this situation occurs, the toe-in of rear wheels should be adjusted.

### 4.8.8 Max steering angle

The maximum steering angle of a car refers to an angle formed between the centerline of the front wheels when not steering and the front wheels turning to the extreme left or right.

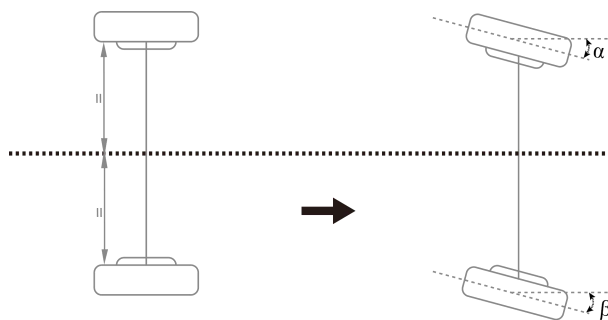

Figure 4.63

### 4.8.9 Wheelbase difference

Wheelbase difference refers to the angle between the line connecting the centers of the two front wheels and the line connecting the centers of the two rear wheels (also known as wheelbase deviation). When the distance between the right wheel and the left wheel is greater, this state defines the wheelbase difference as a positive value. Conversely, when the distance between the right wheel and the left wheel is smaller, this state defines the wheelbase difference as a negative value. If the track widths of the front and rear wheels of the car are already known in the car's specifications, the wheelbase difference can be expressed in angular values, as shown in Figure 4.64.

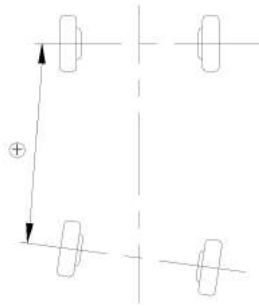

Figure 4.64

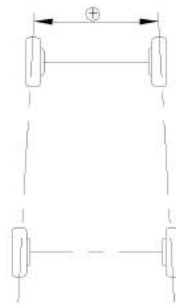

Figure 4.65

### 4.8.10 Track width difference

Track width difference refers to the angle formed by the line connecting the front left wheel and the contact point with the ground, and the line connecting the rear left wheel and the contact point with the ground (also known as the wheel track width deviation). When the distance between the center lines of the two rear wheels is greater than the distance between the center lines of the two front wheels, this state defines the track width difference as a positive value. Conversely, it is a negative value. If the left and right wheelbase of the car is already known, the track width difference can be expressed in angular values, as shown in Figure 4.65.

### 4.8.11 Left (right) lateral offset (angle)

The relative offset between the rear left (right) wheel and the front left (right) wheel in the lateral direction of the car is the lateral offset on the left (right) side. When the rear left (right) wheel is more inclined outward than the front left (right) wheel, the left (right) lateral offset is positive, otherwise it is negative. The angle between the line connecting the center of the front and rear left (right) wheels and the thrust line is the left (right) lateral offset angle.

### 4.8.12 Axle offset (angle)

Axle offset refers to the relative offset of the front and rear axles in the lateral direction of a car. When the rear axle is offset to the right compared to the front axle, the axle offset is a positive value; otherwise, it is a negative value. The angle formed between the bisector of the track width difference angle and the thrust line is known as the axle offset angle.

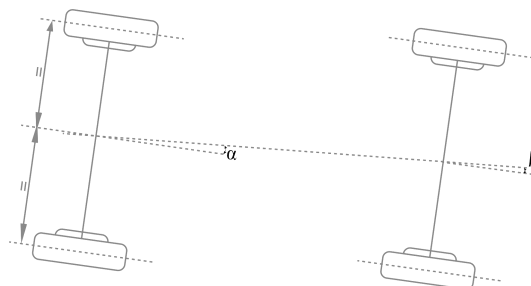

Figure 4.66

#### 4.8.13 Delay (angle)

The relative offset in the longitudinal direction of a car between the two wheels on the same axle is referred to as "delay". When the right wheel on the front (rear) axle is behind the left wheel, the front (rear) delay is a positive value; otherwise, it is a negative value. The angle between the centerline connecting the two front (rear) wheels and the line perpendicular to the longitudinal geometrical centerline of the car is called the front (rear) delay angle.

#### 4.8.14 Included angle

The angle  $\gamma$  between the kingpin axis and the wheel axis is called the included angle, the value of which is the sum of the kingpin inclination  $\alpha$  and the wheel camber  $\beta$ , as shown in Figure 4.67.

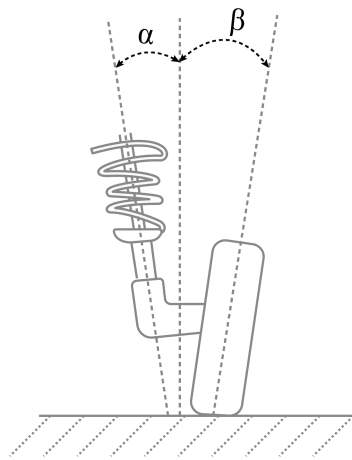

Figure 4.67

#### 4.8.15 Wheel alignment

Half of the difference between the left toe-in and the right toe-in of the front wheel.

#### 4.8.16 Symmetric value

The geometric dimensions of a vehicle are usually symmetrical and are used to preliminarily determine whether the vehicle has been involved in an accident and the condition of the chassis, assisting in four-wheel alignment.

## FCC Warning

Changes or modifications not expressly approved by the party responsible for compliance could void the user's authority to operate the equipment.

This device complies with Part 15 of the FCC Rules. Operation is subject to the following two conditions:

- (1) this device may not cause harmful interference, and
- (2) this device must accept any interference received, including interference that may cause undesired operation.

This transmitter must not be co-located or operating in conjunction with any other antenna or transmitter.

Note: This equipment has been tested and found to comply with the limits for a Class B digital device, pursuant to Part 15 of the FCC Rules. These limits are designed to provide reasonable protection against harmful interference in a residential installation. This equipment generates, uses, and can radiate radio frequency energy, and if not installed and used in accordance with the instructions, may cause harmful interference to radio communications. However, there is no guarantee that interference will not occur in a particular installation. If this equipment does cause harmful interference to radio or television reception, which can be determined by turning the equipment off and on, the user is encouraged to try to correct the interference by one or more of the following measures:

- Reorient or relocate the receiving antenna.
- Increase the separation between the equipment and receiver.
- Connect the equipment into an outlet on a circuit different from that to which the receiver is connected.
- Consult the dealer or an experienced radio/TV technician for help.

This device complies with FCC radiation exposure limits set forth for an uncontrolled environment. This device should be installed and operated with minimum distance 20cm between the radiator & your body.

Note: Indoor use only.



## Warranty

THIS WARRANTY IS EXPRESSLY LIMITED TO PERSONS WHO PURCHASE SMARTSAFE PRODUCTS FOR PURPOSES OF RESALE OR USE IN THE ORDINARY COURSE OF THE BUYER'S BUSINESS.

SMARTSAFE electronic product is warranted against defects in materials and workmanship for one year from date of delivery to the user.

This warranty does not cover any part that has been abused, altered, used for a purpose other than for which it was intended, or used in a manner inconsistent with instructions regarding use. The exclusive remedy for any automotive meter found to be defective is repair or replacement, and SMARTSAFE shall not be liable for any consequential or incidental damages.

Final determination of defects shall be made by SMARTSAFE in accordance with procedures established by SMARTSAFE. No agent, employee, or representative of SMARTSAFE has any authority to bind SMARTSAFE to any affirmation, representation, or warranty concerning SMARTSAFE automotive meters, except as stated herein.

## Disclaimer

The above warranty is in lieu of any other warranty, expressed or implied, including any warranty of merchantability or fitness for a particular purpose.

## Purchase Order

Replaceable and optional parts can be ordered directly from your SMARTSAFE authorized dealer. Your order should include the following information:

- Order quantity
- Part number
- Part name

## Customer Service Center

For any problem met during the operation, please call +86-0755-89589810.

If the device needs to be repaired, please send it back to SmartSafe, and attach the Warranty Card, Product Qualification Certificate, Purchase Invoice and problem description. SmartSafe will maintain and repair the device for free when it is within warranty period. If it is out of warranty, SmartSafe will charge the repair cost and return freight.

SmartSafe address:

3310, Building 11, Tian'an Cloud Park, Bantian Street, Longgang District, Shenzhen, Guangdong, China

SmartSafe Website: <http://www.newsmartsafe.com>

## Statement:

SMARTSAFE reserves the rights to make any change to product designs and specifications without notice. The actual object may differ a little from the descriptions in the manual in physical appearance, color and configuration. We have tried our best to make the descriptions and illustrations in the manual as accurate as possible, and defects are inevitable, if you have any question, please contact local dealer or after-sale service center of SMARTSAFE, SMARTSAFE does not bear any responsibility arising from misunderstandings.