

Copyright Information

Copyright © 2021 by SHENZHEN SMARTSAFE TECH CO.,LTD. All rights reserved. No part of this publication may be reproduced, stored in a retrieval system, or transmitted in any form or by any means, electronic, mechanical, photocopying, recording or otherwise, without the prior written permission of SMARTSAFE.

Neither SMARTSAFE nor its affiliates shall be liable to the purchaser of this unit or third parties for damages, losses, costs, or expenses incurred by purchaser or third parties as a result of: Accident, misuse, or abuse of this unit, or unauthorized modifications, repairs, or alterations to this unit, or failure to strictly comply with SMARTSAFE operating and maintenance instructions. SMARTSAFE shall not be liable for any damages or problems arising from the use of any options or any consumable products other than those designated as Original SMARTSAFE Products or SMARTSAFE Approved Products by SMARTSAFE.

All information, specifications and illustrations in this manual are based on the latest information available at the time of printing. SMARTSAFE reserves the right to make changes at any time without prior written or oral notice.

Trademark Information

SmartSafe is a registered trademark of SHENZHEN SMARTSAFE TECH CO.,LTD. in China and other countries. All other SMARTSAFE trademarks, service marks, domain names, logos, and company names referred to in this manual are either trademarks, registered trademarks, service marks, domain names, logos, company names of SMARTSAFE or are otherwise the property of SMARTSAFE or its affiliates. In countries where any of the SMARTSAFE trademarks, service marks, domain names, logos and company names are not registered, SMARTSAFE

claims other rights associated with unregistered trademarks, service marks, domain names, logos, and company names. Other products or company names referred to in this manual may be trademarks of their respective owners. You may not use any trademark, service mark, domain name, logo, or company name of SMARTSAFE or any third party without permission from the owner of the applicable trademark, service mark, domain name, logo, or company name. You may contact SMARTSAFE by visiting the website at www.newsmartsafe.com, or writing to SHENZHEN SMARTSAFE TECH CO.,LTD., 3310, Building 11, Tianan Cloud Park, Bantian Street, Longgang District, Shenzhen, Guangdong, China, to request written permission to use Materials on this manual for purposes or for all other questions relating to this manual.

To avoid personal injury, property damage, or accidental damage to the product, please read all the information in this chapter before using the product.

Safety Warning

The design, manufacture and testing of the tester are up to IEC61010 safety standards (safety requirements for electrical measurement products). This manual includes warnings and safety regulations ensuring the safe use and state of the tester, which must be followed by users. Please carefully read the following operating instructions before the use.

Warning:

- Please carefully read and understand this instruction manual before using the tester.
- Always comply with the requirements of this user manual and keep it available for reference.
- During testing, incorrect operation can result in accidents and

damage to the tester.

Conventions

The following conventions are used in this manual.

Hazards

To avoid possible serious or fatal damage under certain conditions and operations.

- Do not measure circuits with AC/DC voltage above 600V.
- Do not test in inflammable places because sparks may cause explosion.
- Do not operate the tester if its surface is wet or the operator's hand is wet.
- When measuring, do not touch the conductive part of the test pen.
- Do not press **TEST** button when the test clip is short-circuited to the tester.
- Do not touch the circuit to be measured when performing insulation test.

Warning:

To avoid the danger of electric shock.

- If the tester is broken or metal parts are exposed, please stop using it.
- After high resistance measurements, charge storage in the circuit to be measured must be released.
- Ensure that all test clips are securely connected to the tester's test ports.
- The tester is a sealed device without repairable parts inside for end users. Do not attempt to disassemble it by yourself. All internal repairs must be performed by an authorized maintenance organization or technician. Attempts to disassemble or modify the equipment will void the warranty.

Notes

Helpful information is presented to avoid damage to the tester and to make accurate measurements.

- Before measuring resistance, the circuit to be measured must be completely discharged and isolated from the power circuit.
- If the test clip or power adapter needs to be replaced because of damage, replace it with that of the same model or electrical specifications.
- Do not use the tester if the battery indicator indicates that the battery is out of power.
- Do not store or use the tester in the high temperature, high humidity, flammable, explosive environment, and strong electromagnetic field fields.
- Please use a damp cloth or cleaner to clean the tester housing. Do not use friction or solvents.

When the tester is wet, please dry it before storage.

Contents

1. Product Introduction	1
1.1 Overview	1
1.2 Packing List	1
1.3 Composition	2
1.4 Technical Parameters	4
2. Operating	6
2.1 Charging and On/Off	6
2.1.1 Charging	6
2.1.2 Turn On/Off	6
2.2 Display	7
2.3 Measurement	7
2.3.1 AC/ DC voltage measurement	8
2.3.2 Insulation Resistance Measurement	10
2.3.3 Single-point calibration of onboard resistance	13
3. Maintenance	16
FCC Warning	17
Warranty	18

1. Product Introduction

1.1 Overview

With microcomputer technology design as the core, and a combination of large-scale integrated circuit and digital circuit, iSmartEV RT100 insulation tester is equipped with powerful measurement and data processing software; thus, it can complete measurement of the insulation resistance, voltage, and other parameters. Its stable performance and easy operation are suitable for field measurement and maintenance users of power equipment and power supply line.

It features the following:

- Automatic high voltage residual release function.
- Support resistance measurement and AC/DC voltage measurement.
- Support insulation resistance measurement modes such as comparative measurement, continuous measurement, and fixed-time measurement.
- Multiple voltage output of 500V, 1000V, 2500V and 5000V.
- Backlight function for working at night or in the dim environment.
- Alarm function for test voltage and resistance overrange.
- Automatic shutdown function (the tester automatically shuts down when it is not operated for 15 minutes in the resistance test mode).
- Large display facilitates observation of measurement results.

1.2 Packing List

The following list is for reference only. For details, please consult your local distributor or check the attached packing list.

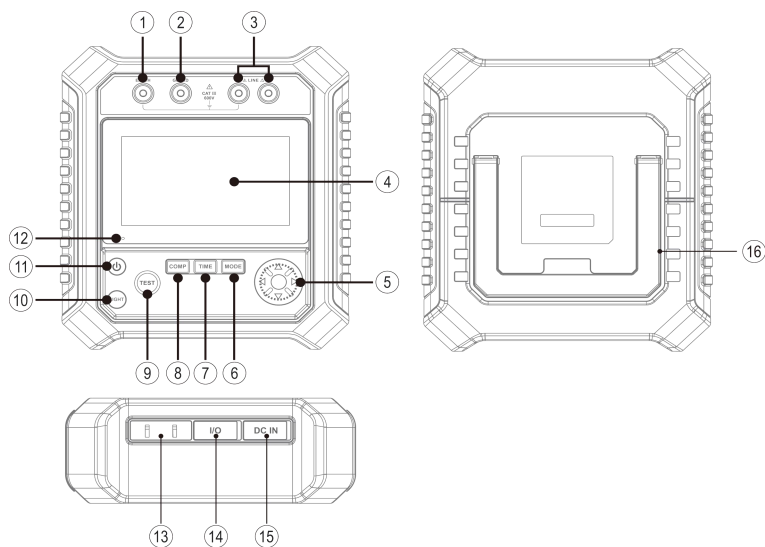

- iSmartEV RT100 insulation tester X 1
- Switching Power Supply X 1
- Test Clip X 3
- User Manual X 3
- Packing list X 1

1.3 Composition



No.	Name	Description
1	Earth Port	Connected to a green single-cord wire.
2	GUARD Port	Connected to a black single-cord wire.
3	LINE Port	Connected to a double-cord red wire.
4	Display	5-inch display.
5	Selection Buttons	⏪/⏩: When the insulation resistance measurement is not started, it is used to adjust the measured output voltage value.

		<p>↶: When the insulation resistance is measured periodically, it is used to decrease the measurement duration; When the comparative measurement mode is used to measure the insulation resistance, it is used to decrease the resistance comparison value.</p> <p>↷: When the insulation resistance is measured periodically, it is used to increase the measurement duration; When the comparative measurement mode is used to measure the insulation resistance, it is used to increase the resistance comparison value.</p>
6	MODE	<p>Switch button for the resistance/voltage measurement mode.</p> <p>The insulation resistance measurement mode (continuous measurement mode) is by default while startup. Press this button to switch to the DC voltage measurement mode. Press it again to enter the AC voltage mode, and press it again to exit the voltage measurement mode and back to the insulation resistance measurement mode, which is loop selection.</p>
7	TIME	Click it to switch between "Fixed-time Measurement" and "Continuous measurement" modes.
8	COMP	"Comparative measurement" mode for insulation resistance measurement.
9	TEST	Enable and disable measurement (press the button for 1 second to enable measurement).
10	LIGHT	Turn on/off the backlight.
11	Power Button	<p>In the shutdown state, long press this button until the TEST button is lit, and the tester is initialized and powered on.</p> <p>Press this button for 3 seconds to shut down under the startup state.</p> <p> Note: The tester will automatically shut down after no operation for more than 15 minutes (manual shutdown is required in the voltage measurement mode).</p>
12	Charging	It shows red while charging and green after fully charged.

	Indicator	
13	Calibration Terminal	For tester verification tests and standard resistance calibration.
14	USB Type-C Port	Reserved expansion port.
15	DC IN Power Jack	<p>For connection of the power adapter.</p> <p> Warning: Please use the attached power adapter for charging. We will not be responsible for any damage or loss caused by charging with a power adapter not designated by us.</p> <p> Note: The tester will not work during charging to ensure personal safety.</p>
16	Holder	For support during tester operation.

1.4 Technical Parameters

• Insulation Test

Test Voltage	500V	1000V	2500V	5000V
Measurement Range	10MΩ~20GΩ	10MΩ~40GΩ	10MΩ~100GΩ	10MΩ~1000GΩ
Open Circuit Voltage	DC500V 0~20%	DC1000V 0~20%	DC2500V 0~20%	DC5000V 0~20%
Measurement Accuracy	1MΩ~99.9MΩ: ± (3%+5) 100MΩ~9.99GΩ: ± (5%+5) 10.0GΩ~100.0GΩ: ± (10%+5) >100GΩ: ± (20%+5)			
Short-Circuit Current	<3.0mA			

• AC/DC Voltage Testing

Voltage Type	DC Voltage	AC Voltage
Measurement Range	$\pm 30 \sim \pm 600V$	30~600V
Resolution	1V	1V
Measurement Accuracy	$\pm 2\%$	$\pm 2\%$

 *Note: Under any test voltage, if the measured resistance is less than 10MΩ, do not continuously measure for more than 10 seconds.*

Display	5-inch display
Battery	3150mAh/11.4V
Working Temperature	0~50℃
Storage Temperature	-20℃ ~ 70℃
Dimension	190*207*72mm

2. Operating

2.1 Charging and On/Off

2.1.1 Charging

 *Note: After using the tester for the first time or not using the tester for a long time, the tester may fail to start up because of low battery. Please charge the tester for a period before trying to start up.*

Please charge as below methods:

Plug one end of the power adapter into the DC IN charging jack of the tester and connect the other end to the AC power outlet. If the charging indicator on the tester lights up in red, it indicates charging, the indicator lights up in green after fully charging.

2.1.2 Turn On/Off

In the shutdown state, long press the **Power** button on the tester until the **TEST** button is lit, the tester will be initialized and powered on, and the system will have a buzzer prompt.

To shut down, long press the **Power** button on the tester for 3 seconds until the screen is off.

The tester will automatically shut down when it is not operated for more than 15 minutes in the resistance measurement mode. If the tester is in the voltage measurement mode, it needs to be shut down manually.

 *Note: To ensure safety, the tester will automatically shut down when charging.*

2.2 Display

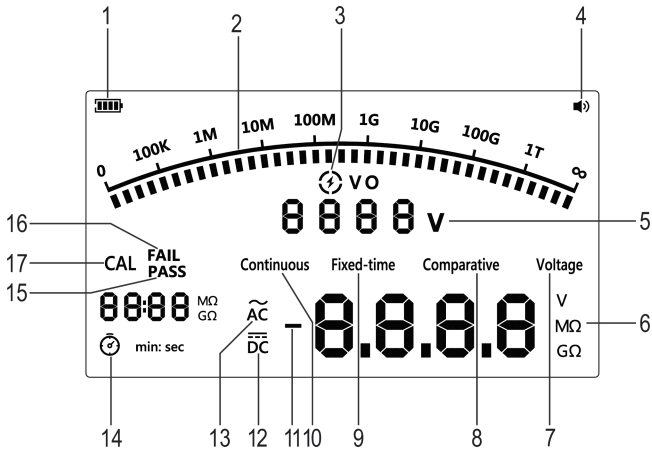

No.	Name	No.	Name
1	Battery Indicator	10	Continuous Measurement Prompt
2	Scale	11	Negative Pole Symbol
3	High Voltage Prompt	12	DC Voltage Symbol
4	Buzzer Symbol	13	AC Voltage Symbol
5	Output Voltage	14	Timing Display
6	Unit Symbol	15	Pass (Pass the Comparative Measurement) Prompt
7	Voltage Measurement Prompt	16	Fail (Not Pass the Comparative Measurement) Prompt
8	Comparative Measurement Prompt	17	Calibration Identifier
9	Fixed-time Measurement Prompt		

2.3 Measurement

Preparation before measurement:

(1) Press the **Power** button to start up. The insulation resistance

continuous measurement mode is preset when startup, and the output voltage is 500V.

- (2) Please make sure that the tester is fully charged (if the battery icon is blank, it needs to be charged before testing).

2.3.1 AC/ DC voltage measurement

- (1) The insulation resistance continuous measurement mode is by default while startup. Press the **MODE** button to switch to the DC voltage measurement mode, and press the **MODE** button again to enter the AC voltage measurement mode.

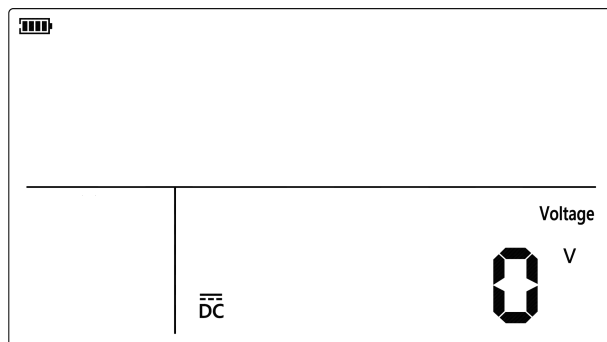
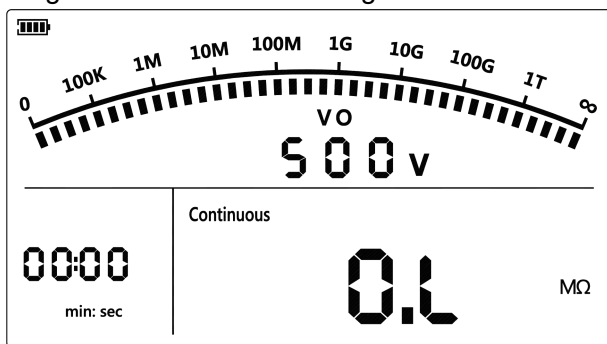

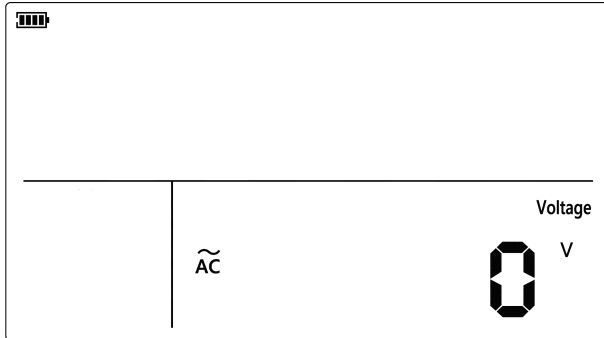

- (2) Insert the red test clip into the **LINE** port on the tester and the green test clip into the **Earth** port on the tester.
- (3) Connect the red and green alligator clips to the circuit to be tested. When measuring DC voltage, if the red test clip is negative voltage, the negative pole symbol "-" will be displayed on the screen.

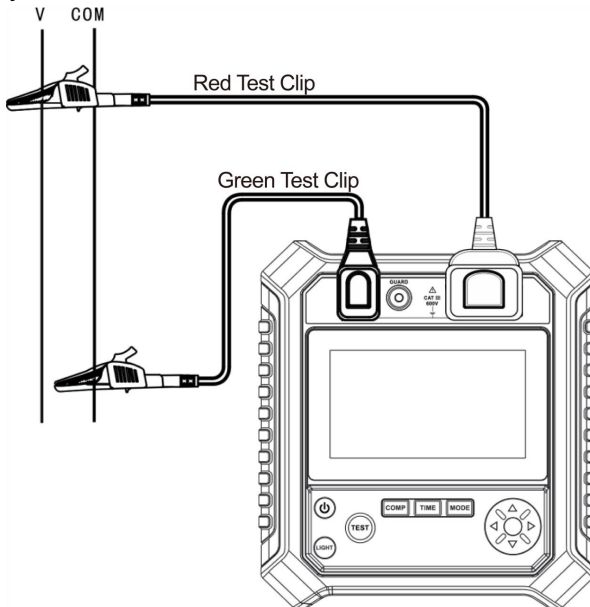

Note:

- Do not input a voltage higher than 600V or 600Vrms. Measuring higher voltages risks may damage the tester.
- Special attention should be paid to avoid electric shock when measuring high voltages.
- After completing all measurement, disconnect the test clip from the circuit to be tested and remove the test clip from the tester input.
- If the voltage measurement exceeds the maximum range, the buzzer will sound.

2.3.2 Insulation Resistance Measurement

Note: The continuous measurement mode is by default for insulation resistance measurement during startup.

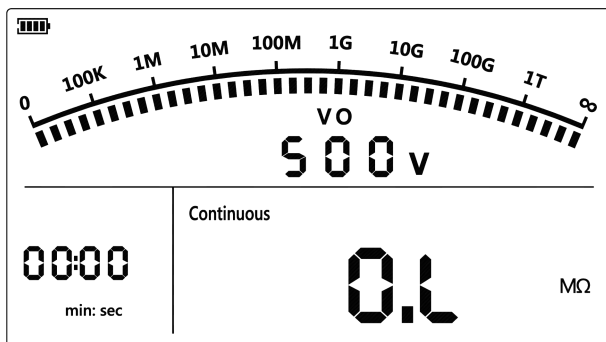

- (1) Before measuring insulation resistance, the circuit to be measured must be completely discharged and isolated from the power circuit.
- (2) Insert the red test clip into the LINE port, the black test clip into the GUARD port, and the green test clip into the EARTH port.
- (3) Connect the red and green alligator clips to the measured



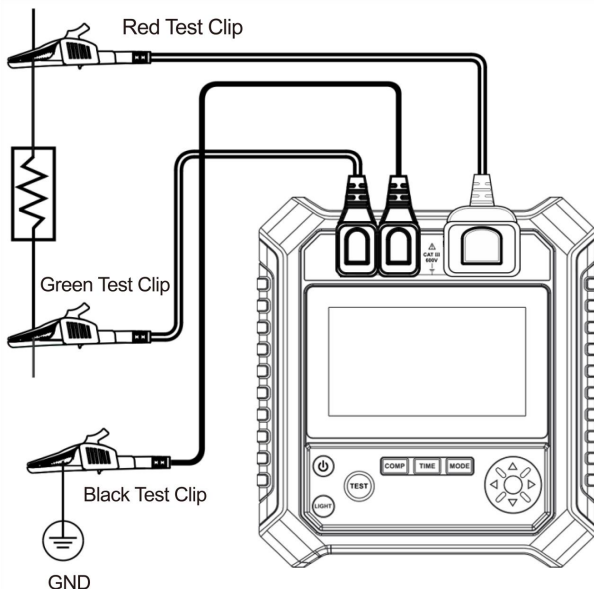

object and output the voltage from the LINE port.



(4) Select the following insulation resistance measurement mode.

- After the system is powered on, the system enters the insulation resistance continuous measurement mode by default. Press \uparrow / \downarrow to select the output voltage and press **TEST** for 1 second to start measurement. At the same time, the buzzer will sound. The measured insulation resistance value will be displayed on the screen.
- Press the **TIME** button to select the fixed-time measurement mode. Fixed-time measurement prompt and timing symbols will be displayed on the screen. Press the \uparrow / \downarrow buttons to adjust the output voltage and press the \leftarrow / \rightarrow buttons to set the timing duration (setting range from 00:10 to 15:00). Press the **TEST** button for 1 second to start the fixed-time measurement.

The timer area of the screen starts to display a countdown. The system will automatically end the measurement at the set time.

- Press the **COMP** button to enter the insulation resistance comparative measurement mode, and the comparative measurement prompt will appear on the screen. Press the / buttons to select an output voltage and press the / buttons to set the comparative resistance (setting range: 10MΩ ~ 900GΩ). Press the **TEST** button for 1 second to start the measurement. If the insulation resistance measurement value is smaller than the resistance comparative value, the "FAIL" prompt will be displayed in the lower left corner of the screen; otherwise, the "PASS" prompt will be displayed.

 **Note:**

- *Before the test, ensure that the circuit to be measured is not electrified. Do not measure the insulation of electrified equipment or circuit.*
- *The tester has dangerous voltage output. Please be careful while operating. Never press the **TEST** button to output the high voltage before ensuring that the tested circuit is firmly clamped and the hand is off the test clamp.*
- *Do not short circuit two test clips or measure the insulation resistance under the high voltage output. This operation is easy to spark and cause fire, and damage the tester.*
- *If the resistance measurement exceeds the maximum range, the buzzer will sound.*

Schematic Diagram of Insulation Resistance Measurement Mode Switching

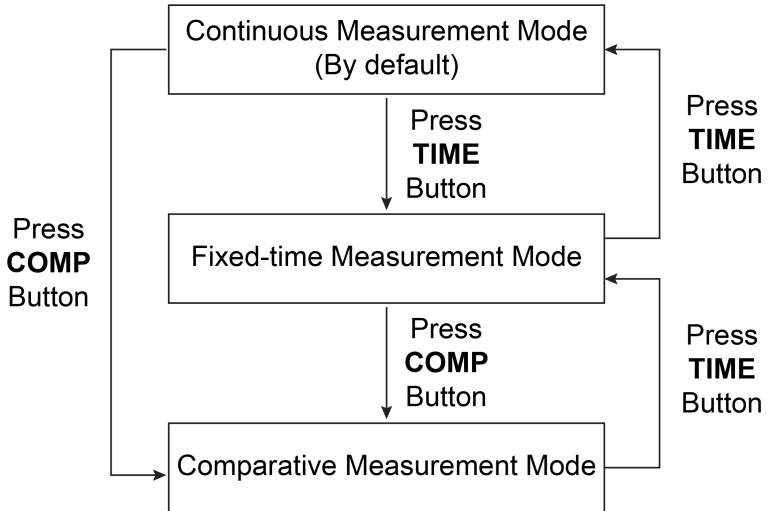

2.3.3 Single-point calibration of onboard resistance

After using the tester for a period, it is recommended to calibrate the onboard resistance. The specific steps are as follows:

- (1) Connect the test clip to the resistance calibration terminal on the tester as shown below.

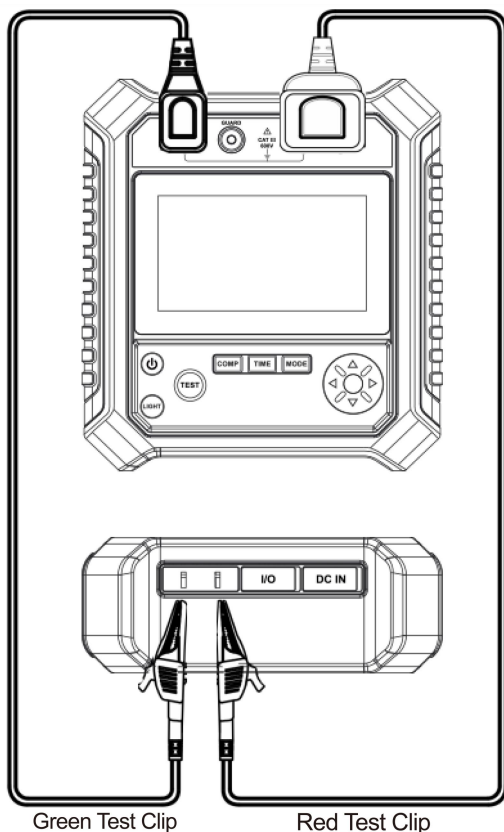

- (2) Under the startup state, long press the **COMP** button to enter the calibration state of 200M Ω resistance. The screen will display the character of **CAL** and the resistance value of 200M Ω .

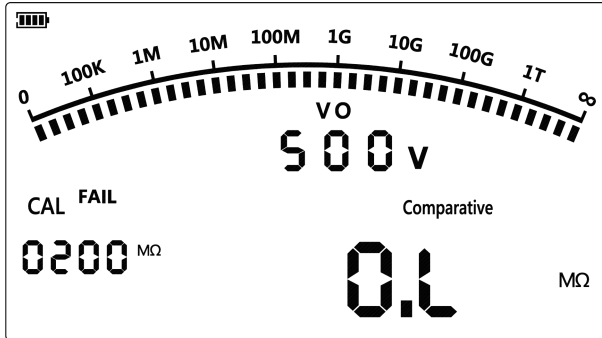

- (3) Long press the **TEST** button to start the measurement, and then press the **TEST** button to finish the measurement when the value is stable.
- (4) Long press the **COMP** button for 5 seconds to exit the calibration, then the calibration is complete.

Note: It is unavailable to switch to other measurement modes under the calibration mode. You need to exit the calibration mode before other measurements.

3. Maintenance

- Please use clean water wet soft cloth or sponge (without clear water residue) to wipe the surface of the casing.
- Do not immerse the tester in water to avoid damaging it.
- When the tester is wet, please dry it before storage.
- When it is necessary to calibrate or repair the tester, please submit the tester to professional maintenance personnel or designated maintenance department.

FCC Warning

Changes or modifications not expressly approved by the party responsible for compliance could void the user's authority to operate the equipment.

This device complies with Part 15 of the FCC Rules. Operation is subject to the following two conditions:

- (1) this device may not cause harmful interference, and
- (2) this device must accept any interference received, including interference that may cause undesired operation.

This transmitter must not be co-located or operating in conjunction with any other antenna or transmitter.

Note: This equipment has been tested and found to comply with the limits for a Class B digital device, pursuant to Part 15 of the FCC Rules. These limits are designed to provide reasonable protection against harmful interference in a residential installation. This equipment generates, uses, and can radiate radio frequency energy, and if not installed and used in accordance with the instructions, may cause harmful interference to radio communications. However, there is no guarantee that interference will not occur in a particular installation. If this equipment does cause harmful interference to radio or television reception, which can be determined by turning the equipment off and on, the user is encouraged to try to correct the interference by one or more of the following measures:

- Reorient or relocate the receiving antenna.
- Increase the separation between the equipment and receiver.
- Connect the equipment into an outlet on a circuit different from that to which the receiver is connected.
- Consult the dealer or an experienced radio/TV technician for help.

The device has been evaluated to meet general RF exposure requirement. The device can be used in portable exposure condition without restriction.

Warranty

This WARRANTY applies only to customers and dealers who have purchased SmartSafe products through normal procedures.

Within one year from the date of delivery, SmartSafe Company shall guarantee the defects of its electronic products caused by materials or processes. Damage of the equipment or components caused by abuse, unauthorized modification, use for purposes other than the design of the product, or failure to operate in the way specified in the instruction shall not be covered by this warranty.

Disclaimer

The warranty mentioned above may supersede any other warranty.

Order notification

The replaceable parts and optional parts can be ordered directly from the suppliers authorized by SmartSafe. Please specify when ordering:

- Quantity ordered
- Part number
- Part name

Customer Service Center

If the equipment needs to be repaired, please send the equipment to SmartSafe, together with the purchase invoice and problem description. If the equipment is within the scope of the warranty, SmartSafe offer free maintenance; If the equipment is outside the scope of the warranty, SmartSafe will charge for maintenance and return freight.

Address of SmartSafe Company:

3310, Building 11, Tian 'an Yungu Industrial Park, Bantian Street, Longgang District, Shenzhen, Guangdong, China. Postcode: 518110

Statement: The Company reserves the right to change the product design and specifications without prior notice. The appearance and color of the object may be different from that shown in the instruction manual. The object shall prevail. We have tried our best to make all the descriptions in the book accurate, but there are still some inaccuracies. If you have any doubt, please contact the distributor or after-sales service center. The company will not assume any consequences caused by misunderstanding.