

Version: V1.00.000

Revised date: 08-26-2021

## **Copyright Information**

Copyright © 2021 by SHENZHEN SMARTSAFE TECH CO.,LTD. (also called SMARTSAFE for short). All rights reserved. No part of this publication may be reproduced, stored in a retrieval system, or transmitted in any form or by any means, electronic, mechanical, photocopying and recording or otherwise, without the prior written permission.

Statement: SMARTSAFE owns the complete intellectual property rights for the software used by this product. For any reverse engineering or cracking actions against the software, SMARTSAFE will block the use of this product and reserve the right to pursue their legal liabilities.

## **Disclaimer of Warranties and Limitation of Liabilities**

All information, illustrations, and specifications in this manual are based on the latest information available at the time of publication.

The right is reserved to make changes at any time without notice. We shall not be liable for any direct, special, incidental, indirect damages or any economic consequential damages (including the loss of profits) due to the use of the document.

## Important Safety Precautions

To avoid personal injury, property damage, or accidental damage to the product, read all of the information in this section before using the tool.

### **DANGER**

- When an engine is operating, keep the service area well-ventilated or attach a building exhaust removal system to the engine exhaust system. Engines produce various poisonous compounds (hydrocarbon, carbon monoxide, nitrogen oxides, etc.) that cause slower reaction time and result in death or serious personal injury.
- Please use the included battery and power adaptor. Risk of explosion if the battery is replaced with an incorrect type.
- DO NOT attempt to operate the tool while driving the vehicle. Have second personal operate the tool. Any distraction may cause an accident.

### **WARNING**

- Always perform automotive testing in a safe environment.
- Do not connect or disconnect any test equipment while the ignition is on or the engine is running.
- Before starting the engine, put the gear lever in the Neutral position (for manual transmission) or in the Park (for automatic transmission) position to avoid injury.
- NEVER smoke or allow a spark or flame in vicinity of battery or engine. Do not operate the tool in explosive atmospheres, such as in the presence of flammable liquids, gases, or heavy dust.
- Keep a fire extinguisher suitable for gasoline/chemical/electrical fires nearby.
- Wear an ANSI-approved eye shield when testing or repairing vehicles.
- Put blocks in front of the drive wheels and never leave the vehicle unattended while testing.
- Use extreme caution when working around the ignition coil, distributor cap, ignition wires and spark plugs. These components create hazardous voltage when the engine is running.
- To avoid damaging the tool or generating false data, please make sure the vehicle battery is fully charged and the connection to the vehicle DLC (Data Link Connector) is clear and secure.

- Automotive batteries contain sulfuric acid that is harmful to skin. In operation, direct contact with the automotive batteries should be avoided. Keep the ignition sources away from the battery at all times.
- Keep the tool dry, clean, free from oil, water or grease. Use a mild detergent on a clean cloth to clear the outside of the equipment when necessary.
- Keep clothing, hair, hands, tools, test equipment, etc. away from all moving or hot engine parts.
- Store the tool and accessories in a locked area out of the reach of children.
- Do not use the tool while standing in water.
- Do not expose the tool or power adapter to rain or wet conditions. Water entering the tool or power adaptor increases the risk of electric shock.
- This tool is a sealed unit. There are no end-user serviceable parts inside. All internal repairs must be done by an authorized repair facility or qualified technician. If there is any inquiry, please contact the dealer.
- Keep the tool far away from magnetic devices because its radiations can damage the screen and erase the data stored on the tool.
- Do not attempt to replace the internal rechargeable lithium battery. Contact the dealer for factory replacement.
- Do not disconnect battery or any wiring cables in the vehicle when the ignition switch is on, as this could avoid damage to the sensors or the ECU.
- Do not place any magnetic objects near the ECU. Disconnect the power supply to the ECU before performing any welding operations on the vehicle.
- Use extreme caution when performing any operations near the ECU or sensors. Ground yourself when you disassemble PROM, otherwise ECU and sensors can be damaged by static electricity.
- When reconnecting the ECU harness connector, be sure it is attached firmly, otherwise electronic elements, such as ICs inside the ECU, can be damaged.

## Table of Contents

<b>1 Introduction.....</b>	<b>1</b>
1.1 PACKAGE LIST.....	1
1.2 COMPONENTS & CONTROLS.....	4
1.3 TECHNICAL PARAMETERS.....	5
<b>2 Initial Use.....</b>	<b>6</b>
2.1 CHARGING & TURNING ON.....	6
2.2 PRINTER SETTING.....	6
2.3 BASIC OPERATIONS.....	7
2.4 CHANGE SYSTEM LANGUAGE.....	7
2.5 NETWORK SETUP.....	8
2.6 REGISTER & DOWNLOAD DIAGNOSTIC SOFTWARE.....	8
2.7 JOB MENU.....	9
<b>3 Vehicle Diagnosis.....</b>	<b>10</b>
3.1 PREPARATION.....	10
3.2 VEHICLE CONNECTION.....	11
3.3 START DIAGNOSTICS.....	12
3.4 FEEDBACK.....	17
<b>4 Battery (only applies to iSmartTool 601BT &amp; iSmartTool 601Max)....</b>	<b>18</b>
4.1 BATTERY TEST.....	18
4.1.1 Out-of-car Inspection.....	18
4.1.2 In-car Inspection.....	20
4.2 BATTERY MATCHING.....	22
<b>5 TPMS (only applies to iSmartTool 601TT &amp; iSmartTool 601Max).....</b>	<b>23</b>
5.1 ACTIVATE TPMS SENSOR.....	23
5.2 PROGRAM TPMS SENSOR.....	24
5.3 TPMS LEARNING.....	26
5.4 TPMS DIAGNOSIS.....	26
<b>6 Maintenance.....</b>	<b>27</b>
6.1 OIL RESET SERVICE.....	27
6.2 ELECTRONIC PARKING BRAKE RESET.....	27
6.3 STEERING ANGLE CALIBRATION.....	28

6.4	ABS BLEEDING.....	28
6.5	TIRE PRESSURE MONITOR SYSTEM RESET.....	28
6.6	GEAR LEARNING.....	28
6.7	IMMO SERVICE.....	28
6.8	INJECTOR CODING.....	29
6.9	BATTERY MAINTENANCE SYSTEM RESET.....	29
6.10	DIESEL PARTICULATE FILTER (DPF) REGENERATION.....	29
6.11	ELECTRONIC THROTTLE POSITION RESET.....	29
6.12	GEARBOX MATCHING.....	30
6.13	AFS (ADAPTIVE FRONT-LIGHTING SYSTEM) RESET.....	30
6.14	SUNROOF INITIALIZATION.....	30
6.15	SUSPENSION CALIBRATION.....	30
6.16	EGR ADAPTION.....	30
6.17	WINDOWS CALIBRATION.....	30
6.18	SEATS CALIBRATION.....	30
6.19	TYRE RESET.....	30
6.20	LANGUAGE CHANGE.....	30
6.21	A/F RESET.....	31
6.22	COOLANT BLEED.....	31
6.23	TRANSPORT MODE.....	31
6.24	ADBLUE RESET (DIESEL ENGINE EXHAUST GAS FILTER).....	31
6.25	NOX SENSOR RESET.....	31
6.26	STOP/START RESET.....	31
<b>7</b>	<b>Update.....</b>	<b>32</b>
7.1	UPDATE DIAGNOSTIC SOFTWARE & APP.....	32
7.2	RENEW SUBSCRIPTION.....	32
<b>8</b>	<b>Videoscope.....</b>	<b>33</b>
<b>9</b>	<b>Personal Center.....</b>	<b>33</b>
9.1	VCI.....	33
9.2	ACTIVATE VCI.....	33
9.3	FIX CONNECTOR FIRMWARE.....	33
9.4	MY ORDER.....	33
9.5	SUBSCRIPTION RENEWAL CARD.....	33
9.6	PROFILE.....	33
9.7	CHANGE PASSWORD.....	33

## iSmartTool Series User Manual

---

9.8 DIAGNOSTIC SOFTWARE CLEAR.....	33
9.9 SETTINGS.....	34
<b>10 FAQ.....</b>	<b>35</b>

# 1 Introduction

## 1.1 Package List

Common accessories are same, but for different destinations, the accessories may vary. The following accessories are for reference only. Please consult from the local agency or check the package list supplied with this tool together.

### For iSmartTool 601Max

No.	Item	Descriptions	Qt.
1	iSmartTool 601Max tool	Indicate the test result.	1
2	Diagnostic cable	Collect the tool to the vehicle's DLC (Data Link Connector) port.	1
3	Battery cable clamps	Connect the vehicle battery to perform the battery detection.	1
4	External power adaptor	Charge the tool via AC outlet.	2
5	USB (Type A to Type C) cable	Connect the tool to the PC or DC external power adaptor	1
6	Password envelope	A piece of paper bearing the product Serial Number and Activation Code for product registration.	1
7	User manual	Instructions on the tool operations.	1
8	Cigarette lighter cable	Supply power to the non-16pin connector from the vehicle's cigarette lighter receptacle.	1
9	OBD I adaptor box	Connect the diagnostic cable and non-16pin adaptor cable.	1
10	Non-16pin adaptor cable kit	Connect to the vehicle equipped with non-OBD II management system.	1



**For iSmartTool 601BT**

<b>No.</b>	<b>Item</b>	<b>Descriptions</b>	<b>Qt.</b>
1	iSmartTool 601BT tool	Indicate the test result.	1
2	Diagnostic cable	Collect the tool to the vehicle's DLC (Data Link Connector) port.	1
3	Battery cable clamps	Connect the vehicle battery to perform the battery detection.	1
4	External power adaptor	Charge the tool via AC outlet.	2
5	USB (Type A to Type C) cable	Connect the tool to the PC or DC external power adaptor	1
6	Password envelope	A piece of paper bearing the product Serial Number and Activation Code for product registration.	1
7	User manual	Instructions on the tool operations.	1

**For iSmartTool 601TT**

<b>No.</b>	<b>Item</b>	<b>Descriptions</b>	<b>Qt.</b>
1	iSmartTool 601TT tool	Indicate the test result.	1
2	Diagnostic cable	Collect the tool to the vehicle's DLC (Data Link Connector) port.	1
3	External power adaptor	Charge the tool via AC outlet.	2
4	USB (Type A to Type C) cable	Connect the tool to the PC or DC external power adaptor	1

## iSmartTool Series User Manual

5	Password envelope	A piece of paper bearing the product Serial Number and Activation Code for product registration.	1
6	User manual	Instructions on the tool operations.	1

### For iSmartTool 601

No.	Item	Descriptions	Qt.
1	iSmartTool 601Max tool	Indicate the test result.	1
2	Diagnostic cable	Collect the tool to the vehicle's DLC (Data Link Connector) port.	1
3	External power adaptor	Charge the tool via AC outlet.	2
4	USB (Type A to Type C) cable	Connect the tool to the PC or DC external power adaptor	1
5	Password envelope	A piece of paper bearing the product Serial Number and Activation Code for product registration.	1
6	User manual	Instructions on the tool operations.	1
7	Cigarette lighter cable	Supply power to the non-16pin connector from the vehicle's cigarette lighter receptacle.	1
8	OBD I adaptor box	Connect the diagnostic cable and non-16pin adaptor cable.	1
9	Non-16pin adaptor cable kit	Connect to the vehicle equipped with non-OBD II management system.	1

## 1.2 Components & Controls

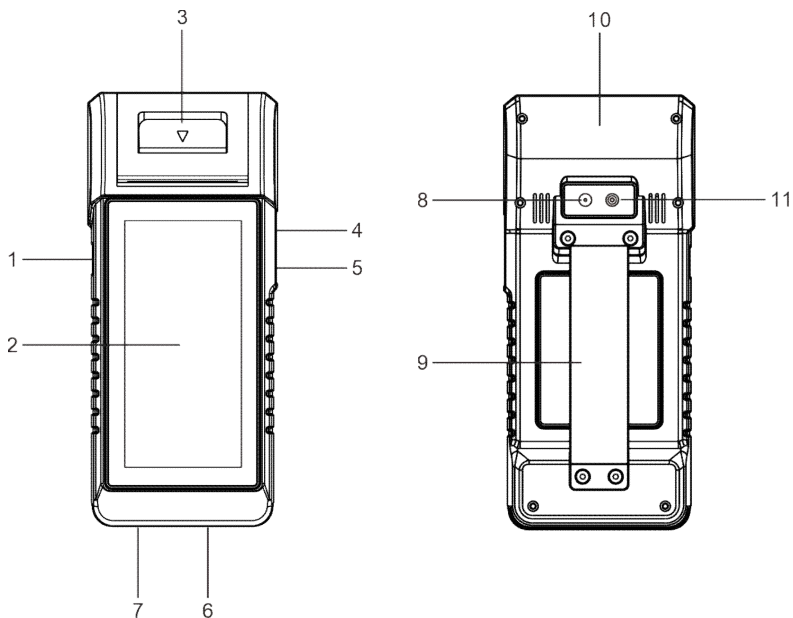

1. POWER key - Press it to turn the tool on/off.

2. LCD screen – Indicates the test results.

3. Printer – Prints the diagnostic reports or screenshots.

4. USB Type A port – Connects the Videoscope or USB storage device.

5. USB Type C port – Connects the power adaptor/PC for charging/data exchange.

6. DB15 diagnostic connector –

Connects the diagnostic cable to the vehicle's DLC (Data Link Connector) port.

7. Circular connector – Connects the battery tester clamps to perform battery detection.

8. Rear camera

9. Handgrip belt

10. TMPS antenna

11 Camera flash

### 1.3 Technical Parameters

Operating system: Android

Memory: 4GB

Storage: 32GB

Screen: 5.99 inch capacitive touch screen with a resolution of 1440 x 720 pixels

Camera: Rear-facing 8.0MP camera

Wi-Fi: 2.4GHz/5GHz dual band

Connectivity:

- DB15 Diagnostic connector
- USB Type A port x 1 + USB Type C port
- Circular Connector for battery tester clamps

Working temperature: 0°C ~ 50°C

Storage temperature: -10°C ~ 60°C

## 2 Initial Use

### 2.1 Charging & Turning On

1. Plug one end of the included USB cable into the USB Type C port of the tool, and the other end to the DC external power adaptor.
2. Plug the other end of the power adaptor to the AC outlet to start charging.
3. Press the **POWER** button to turn the tool on.

 **Caution:** Please use the included power adaptor to charge your tool. No responsibility can be assumed for any damage or loss caused as a result of using power adaptors other than the one supplied.

 **Note:** If the battery remains unused for a long period of time or the battery is completely discharged, it is normal that the tool will not power on while being charged. Please charge it for a period of 5 minutes and then turn it on.

### 2.2 Printer Setting

The tool has a built-in printer available for printing reports or screenshots. The printer applies thermal paper roll with size of  $\Phi 30 \times 57$ mm. Follow the steps described as below to load it.

1. Dig your finger from the gap and lift it up gently until the printer cover is opened.

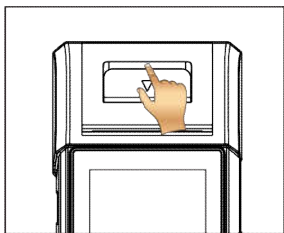

2. Place the unpacked thermal paper into the compartment with its starting end approaching to the paper outlet. Reversing paper direction will result in that no results will be printed out.
3. Pull out some printing paper and introduce it along the slot until it comes out of the paper outlet shown as below. Otherwise, paper can not be fed.

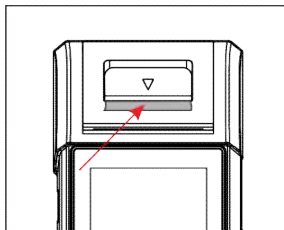

4. Close the paper cover and press it down until you hear a click.

Note: The printer applies the thermal paper, which should be prevented from being heated before printing, otherwise, the paper would be no longer effective or printing results disappear.

### 2.3 Basic Operations



**Single-tap:** To select an item or SMARTSAFE a program.

---



**Double-tap:** To zoom in so that the text on a webpage appears in a column that fits your device's screen.

---



**Long press:** Tap and hold on the desired vehicle software to delete it.

---



**Slide:** To jump to different pages.

**Swipe from the right edge of the screen:** Back to the previous screen or exits.

---

### 2.4 Change System Language

The tool supports multiple system languages. To change the language of the tool, please do the following:

1. On the home screen, tap **Tablet Settings -> System -> Language & input -> Languages**.
2. Tap **Add a language**, and then choose the desired language from the list.
3. Tap and hold the desired language and drag it to the top of the screen and

then release it, the system will change into the target language.

### 2.5 Network Setup

The tool has built-in Wi-Fi that can be used to get online. Once you're online, you can register your tool, surf the Internet, send email, SMARTSAFE the remote diagnosis, and check for software updates etc.

5. On the home screen, tap **Tablet Settings -> Network & Internet -> Wi-Fi**.
6. Slide the Wi-Fi switch to ON, the tool starts searching for available wireless networks.
7. Select a wireless network to connect. When **Connected** appears, it indicates the Wi-Fi connection is complete.



Note: When Wi-Fi is not required, this should be disabled to conserve battery power.

### 2.6 Register & Download Diagnostic Software

Tap **Login** on the upper right corner of the Job menu, the following login popup will appear on the screen.

The image shows a login form with the following elements:

- A text input field labeled "Username" with a red dropdown arrow on the right.
- A text input field labeled "Password".
- A red button labeled "Login".
- Two links at the bottom: "Retrieve Password" and "New Registration".

(If you are a new user, follow **A** to proceed.)

(If you have registered to be a member, go to **B** to login the system directly.)

(In case you forgot password, refer to **C** to reset a new password.)

**A. If you are a new user**, tap **New Registration** and follow the on-screen instructions to finish the registration.

1. Create App account: Fill in the information in each field (Items with \* must be filled). After inputting, tap **Register**.
2. Activate VCI: Input the 12-digit Product Serial Number and 8-digit Activation

Code (can be obtained from the password envelope), and then tap **Activate**.



3. Download diagnostic software: Tap **OK** to enter the update center to download all available software.

**B. If you have registered to be a member**, input your name and password, and then tap **Login** to enter the main menu screen directly.



Note: The tool has an auto-save function. Once the username and password are correctly entered, the system will automatically store it. Next time you login the system, you will not be asked to input the account manually.

**C. If you forgot the password**, tap **Retrieve password** and then follow on-screen instructions to set a new password.

## 2.7 Job Menu

The following modules are included (varies with different models).

### **Battery (Only applies to iSmartTool 601BT & iSmartTool 601Max):**

Perform the battery detection and battery matching. See Chapter 4.

### **TPMS (Only applies to iSmartTool 601TT & iSmartTool 601Max):**

Configure the tool as a professional Tire Pressure Monitoring System (TPMS) service tool. It provides ability to perform all kinds of various TPMS functions. See Chapter 5.

### **Diagnose:**

Diagnose the electronic control units of the vehicle manually. See Chapter 3.

### **Maintenance:**

Perform all kinds of common maintenance and reset items.



**Reports:**

Manage the diagnostic report and recorded data.

**Update:**

Update vehicle diagnostic software and APK.

**Tablet setting:**

Configure the system settings of the tool.

**Videoscope:**

Check the unseen or unreachable parts or components.

**Personal center:**

Manage personal information; configure system settings of the application and logout etc.

**Feedback:**

Feedback the diagnostic issues or bugs to us for analysis and troubleshooting.

**Others:**

Include product manual, remote diagnosis and some frequently used system apps.

## 3 Vehicle Diagnosis

### 3.1 Preparation

- The vehicle ignition is turned on.
- The vehicle battery voltage range is 11-14 volts.
- The throttle is in the closed position.
- Find DLC location.

The DLC(Data Link Connector) is usually located 12 inches from the center of the instrument panel, under or around the driver's side for most vehicles. For some vehicles with special designs, the DLC location may vary. Refer to the following figure for location.

A. Opel, Volkswagen, Audi

B. Honda

C. Volkswagen

D. Opel, Volkswagen, Citroen

E. Changan

F. Hyundai, Daewoo, Kia, Honda, Toyota, Nissan, Mitsubishi, Renault, Opel, BMW, Mercedes-Benz, Mazda, Volkswagen, Audi, GM, Chrysler, Peugeot, Regal, Beijing Jeep, Citroen and other most popular models

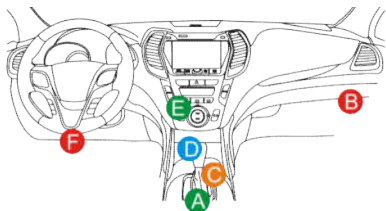

If the DLC cannot be found, refer to the vehicle's service manual for the location.

### 3.2 Vehicle Connection

Follow the steps mentioned below to connect OBD II vehicle:

Connect one end of the included diagnostic cable to the DB15 diagnostic connector, and the other end to the vehicle's DLC port.



For non-OBDII vehicle, proceed as follows:

1. Select the corresponding adaptor cable according to the vehicle's DLC type.
2. Plug the non-16pin end of the adaptor cable into the vehicle's DLC port, then connect the other end to the OBD I adaptor, and then tighten the captive screws.
3. Connect the other end of the OBD I adaptor to the diagnostic cable.

 Note: If the pin of the DLC is damaged or the DLC has insufficient power, you can get power via the Cigarette Lighter Cable: Plug one end of the cigarette lighter cable to the vehicle's cigarette lighter receptacle, and other end to the DC port of the OBD I

adaptor.

### 3.3 Start Diagnostics

Tap a corresponding diagnostic software logo, and then follow the on-screen instruction to access the diagnostic software.

Take Demo (Version 15.32) as an example to demonstrate how to diagnose a vehicle.

- 1). Select diagnostic software version: Tap the **DEMO** to go to Step 2.
- 2). Select vehicle model (varies with different versions): Select the desired vehicle model. Here we take **TOYOTA** for example to demonstrate how to diagnose a vehicle.
- 3). Turn the ignition key to ON: Set the ignition switch to on.
- 4). Read vehicle information: After reading the vehicle information, double check if the vehicle information is correct or not. If yes, tap **Yes** to continue.
- 5). Select test item: Select the desired test item to proceed.



#### 1. Health Report (Quick Test)

It enables you to quickly access all the electronic control units of the vehicle and generate a detailed report about vehicle health.

Tap **Health Report**, the system will start scanning the ECUs. Once the scanning process is complete, the following screen will appear:

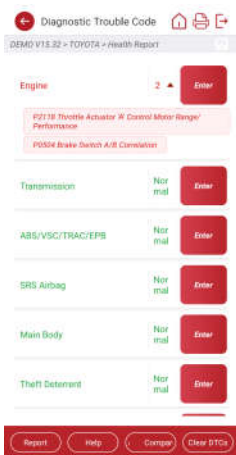

## **Explanation of terms:**

: Back to the Job menu.

: Print the content of the current screen.

: Exit the current program.

**Report:** Save the current data in text format.

**Help:** View the DTC help information.

**Compare Results:** Tap to select the pre-repair report to compare. By comparison of the pre- and post- repair reports, you can easily identify which DTCs are cleared and which remain unfixed.

**Clear DTCs:** Tap to clear the existing diagnostic trouble codes.

## **2. System Scan**

This option allows you to quickly scan which systems are installed on the vehicle.

## **3. System Selection**

This option allows you to manually select the test system and function step by step.

Tap **System Selection** and select the target system (take **Engine** for example) to enter the test function screen.

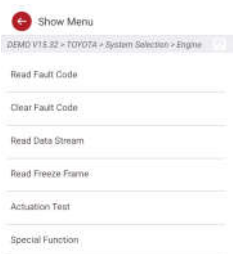

 Note: Different vehicle has different diagnostic menus.

## A. Read Fault Code

This function displays the detailed information of DTC records retrieved from the vehicle's control system.

 Caution: Retrieving and using DTCs for troubleshooting vehicle operation is only one part of an overall diagnostic strategy. Never replace a part based only on the DTC definition. Each DTC has a set of testing procedures, instructions and flow charts that must be followed to confirm the location of the problem. This information can be found in the vehicle's service manual.

Tap **Read Fault Code**, the following screen will appear.

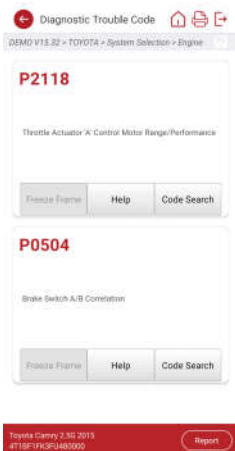

### **Explanation of terms:**

**Freeze Frame:** A snapshot of critical parameter values at the time the DTC is set.

**Help:** View the help information.

**Code Search:** Search for more information about the current DTC online.

**Report:** Save the current data in text format. All reports are saved in **Test report -> Health Report**.

### **B. Clear Fault Code**

This function enables you to erase the codes from the vehicle after reading the retrieved codes from the vehicle and certain repairs have been carried out.

 Note: Make sure the vehicle's ignition key is in the ON position with the engine off before operating.



### **C. Read Data Stream**

This option lets you view and capture (record) real-time Live Data.

 Warning: If you must drive the vehicle in order to perform a troubleshooting procedure, ALWAYS have a second person help you. Trying to drive and operate the diagnostic tool at the same time is dangerous, and could cause a serious traffic accident.

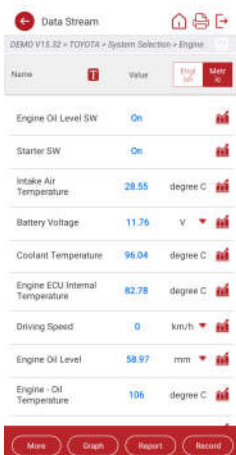
Tap **Read Data Stream** and select the desired data stream items to enter the data stream reading page, which is the Value default mode displaying the parameters in texts and shows in list format.



 Notes: Tap  to set the display style.  indicates sticky top. B indicates this item will be displayed in **Bold**. A indicates this item will be displayed in **Red**.

There are 3 types of display modes available for data viewing, allowing you to view various types of parameters in the most suitable way.

- ✓ Value – Display the parameters in texts and shows in list format.
- ✓ Graph – Display the parameters in waveform graphs.
- ✓ Combine – Display the parameters in merged graph mode for data comparison.

## Explanation of terms:

: View the parameter in waveform graph of the current data stream item.

**Graph:** View the parameters in waveform graphs of all data stream items. When in graph mode, the following operations are supported:

- **Combine** / : Combine different data stream items for data comparison.
- **Value:** View the parameters in text format.

**Compare Sample:** Select the sampled data stream file. All the values you customized and saved in process of data sampling will be imported into the **Standard Range** column for your comparison.

 Note: Before executing this function, you have to sample the values of data stream

items and save it as a sample Data Stream file.

**Save Sample:** Save the running parameters as a data stream sample file.

 **Note:** Only data stream items with measurement units will be recorded.

**Report:** Tap to save the current data in text format. All reports are saved in **Test report -> Health Report**.

**Record:** Tap to start recording diagnostic data. Recorded live data can serve as valuable information to help you in troubleshooting of vehicle problems. All diagnostic records can be replayed from **Test report -> Diagnostic Playback**.

### **D. Actuation Test (Only applies to the iSmartTool 601& iSmartTool 601Max)**

This option is used to access vehicle-specific subsystem and component tests. Available test vary by vehicle manufacturer, year, and model.

### **E. Special Function (Only applies to the iSmartTool 601& iSmartTool 601Max)**

In addition to amazing & powerful diagnostic function, the tool also features various reset functions, which varies from vehicle to vehicle.

## **3.4 Feedback**

This function enables you to feedback the diagnostic issues to us for analysis and troubleshooting.

Tap **Feedback**, and tap **OK** to enter into the vehicle diagnostic record page.

### A. Feedback

Tap the target vehicle to enter the feedback page.

### B. History

Tap it to view the diagnostic feedback logs which are marked with different color indicating the process status of the diagnostic feedback.

### C. Offline list

Tap it to enter the diagnostic feedback offline list page. Once the tool gets a stable network signal, it will be uploaded to the remote server automatically.



## 4 Battery (only applies to iSmartTool 601BT & iSmartTool 601Max)

### 4.1 Battery Test

Battery test is specifically designed to help car owner, repair workshop, battery factory determine whether the battery is normal or not. It supports various battery standards and specifications, including CCA, DIN, IEC, EN, JIS, SAE and GB etc.

Two test modes (Out-of-car Inspection & In-car Inspection) are available and applicable to battery test.

There are mainly 5 battery states as follows:

1. **Good battery** - Indicates that the battery is normal.
2. **Replace battery** - Indicates that the battery is aged or becomes rejected, or battery life cycle is nearly exhausted. In this case, battery voltage appears to be normal, but battery itself is not well, i.e. battery polarity board has been completely vulcanized or aged. Please replace battery immediately.
3. **Good-recharge** - Stands for low battery. The battery is good itself.
4. **Charge-retest** - It is better for a few batteries to be fully charged before testing in order to avoid judging in error under special conditions.
5. **Bad cell** - Indicates one of the battery cells is bad and cannot work normally, but for which one is bad, it can't be verified. In this case, battery voltage is generally lower than 11V, mainly resulting from internal circuitry damage, such as short circuit, open circuit, dummy weld etc.

#### 4.1.1 Out-of-car Inspection

Out-of-car inspection indicates that the battery is disconnected from all loading devices on vehicles. Only battery test is supported for this inspection.

1. Plug one end of the battery cable clamps into the circular connector of the tool. Clamp the BLACK and RED clips of the battery cable clamps on the Negative (-) and Positive (+) terminals of the vehicle battery respectively.

 Note: The cable connector is keyed and will only fit one way. If you have problems connecting the cable connector to the circular connector, rotate it 180° and try again.

2. Tap **Battery -> Out-of-car inspection** on the tool, the following screen will appear:



3. Tap  to scan the barcode on the battery or manually input the code printed on the battery if necessary. Or tap **Next Step** to enter the next step.
4. Do appearance check of the battery or directly tap **Next Step** to ignore it.
5. Select the correct battery type, standard and capacity according to the battery name plate and tap **Start the Detection**.
6. After the detection is complete, the test result and battery state will appear on the screen.

Tap **Save Report** to save the battery test report. The report can be accessed from **Reports -> Battery Report**.



 Note: Where the SOC and SOH indicates the State of Charge and State of Health respectively.

### 4.1.2 In-car Inspection

In-car inspection indicates that the battery connects to loading devices, such as engine, etc.

In this mode, the following tests can be done in a sequence of battery test, start test and charging test.

The **battery test** is used to analyze the health status of the automobile battery, calculate the actual cold starting ability of the battery, judge the aging degree of the battery, and provide reliable analysis basis for the test and maintenance of the battery.

The **start test** is mainly to detect and analyze the starting motor, detect the actual starting current and starting voltage required by the starting motor, so as to judge whether the starting motor is normal or not. The abnormal starting motor may be caused by the following reasons: the lubrication system is faulty, causing the motor to start with the increase of load torque, the rotor of automobile starting motor sweeps the bore, resulting in the increase of self-friction of starting motor.

The **charge test** mainly detects and analyzes the vehicle charging system,

including generator, rectifier, rectifier diode, etc. Through this test, we can know that the output voltage of the generator, the rectifier diode, and the charging current is normal or not respectively.

1. Connect one end of the included diagnostic cable to the DB15 diagnostic connector, and the other end to the vehicle's DLC port.
2. Plug one end of the battery cable clamps into the circular connector of the tool. Clamp the BLACK and RED clips of the battery cable clamps on the Negative (-) and Positive (+) terminals of the vehicle battery respectively.

 Note: The cable connector is keyed and will only fit one way. If you have problems connecting the cable connector to the circular connector, rotate it 180° and try again.

3. Tap **Battery** -> **In-car inspection** on the tool.
4. Follow the on-screen prompts to fill the vehicle information and tap **Next** to continue until the battery test is complete.



5. Tap **Next** and follow the on-screen prompts to do other tests until the whole test is completed.

### Precautions on battery test

The accuracy of battery voltage, charging voltage, start voltage is 0.01V in test results; CCA (Cold Cranking Amps) precision is 5CCA.

Generally, charging voltage value is greater than starting voltage.

Charging voltage range is as follows: 13.8-14.5V for domestic vehicle;

13.3-15.5V for imported vehicles. The voltage varies with different car models, so you have to judge based on related vehicle models. In general, the DC voltage is stable, but it also varies with different revolution speed.

Starting voltage range: The value higher than 9.6V is regular, otherwise it is too low. Due to different situations, whether the starting voltage is higher or not does not mean the vehicles or batteries are faulty. To validate the accuracy of the value, the best method is to collect the signals of starting and charging voltage and observe it on an oscilloscope.

Generally, the voltage is lower than 11V for the bad cell battery, but it is possible that the battery is completely exhausted or has a serious low capacity. In this case, just recharge your battery. Bad cell always happens when the loads on a stopping vehicle are turned on for a long time.

It has no influence on test result in the event that engine's output voltage or engine revolution is not very stable. No matter whether the vehicle is accelerated or not, the output voltage only differs within 0.2V.

While doing In-car inspection, battery cable clamps are always found to be in poor contact. To remain it in good contact, please shake it several times before testing. Take down the battery connector, and test it again, the value probably varies. The deviation may arise from battery connector.

Pay more attention to connect the clip. The battery poles connect with conductor, which makes the clip has a poor connection when testing battery. A tolerance of dozens of CCA occurs if the clip is out of position, or oil, dust attaches on the pole. The gear and main body of clip should be fully matched with battery poles.

 Note: Battery poles inside the vehicle are enveloped by connectors, which may produce some errors for test results. The tolerance results from the resistance of connectors. The greater the resistance value is, the greater the tolerance becomes. But generally, the tolerance does not affect the test conclusion.

### 4.2 Battery Matching

This function enables you to perform a resetting operation on the monitoring unit of vehicle battery, in which the original low battery fault information will be cleared and battery matching will be done.

It needs to be performed in the following cases:

1. The main battery is replaced.
2. The battery monitoring sensor is replaced.

## 5 TPMS (only applies to iSmartTool 601TT & iSmartTool 601Max)

This module provides the ability to activate most OEM/Universal TPMS sensors, reprogram sensor IDs, retrieve/clear TPMS DTCs and relearn sensors, helping technicians quickly find out faulty TPMS and turn off MILs.

In general, the following steps are required for the TPMS detection.

1. Enter TPMS.
2. Select vehicle manufacturer.
3. Select vehicle model and year.
4. Select the TPMS function\*.
5. Follow the on-screen instructions to proceed.

 Note: For indirect TPMS vehicle, only the Learning function is supported. For vehicle using Direct TPMS, it generally includes: Activation, Programming, Learning and Diagnosis. The available TPMS functions may vary for different vehicles being serviced.

### 5.1 Activate TPMS Sensor

This function allows users to activate TPMS sensor to view sensor data such as sensor ID, tire pressure, tire frequency, tire temperature and battery condition.

 Note: The tool will do TPMS test in a sequence of FL (Front Left), FR (Front Right), RR (Rear Right), LR (Rear Left) and SPARE, if the vehicle has the option for the spare. For universal sensors, place the tool alongside the valve stem, point the trigger antenna (located on top of the back of the tool) toward the sensor location, and tap **Active**. Once the sensor is successfully activated and decoded, the screen will display the sensor data.

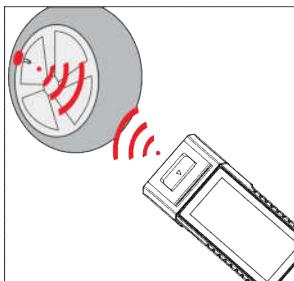

 Notes:

1. For early magnet-activated sensors, place the magnet over the stem and then place

the tool alongside the valve stem.

- If the TPMS sensor requires tire deflation (of the order of 10PSI), then deflate the tire and place the tool alongside the stem while tapping Active.

### 5.2 Program TPMS Sensor

This function allows users to program the sensor data to the specific sensor and replace faulty sensor with low battery life or one that is not functioning.

There are three options available for programming the sensor: Auto Create, Manual Create and Copy by Activation.

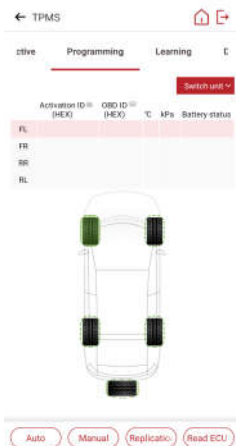

 Note: Do not place the device close to several sensors at the same time, or the diagnostic tool will detect more sensors, which may result in programming failure.

#### Method 1 – Auto Create

This function is designed to program the specific sensor by applying random IDs created according to the test vehicle when it is unable to obtain the original sensor ID.

- Select the wheel which needs to be programmed on the tool, place a sensor close to the TPMS antenna of the tool, and tap **Auto** to create a new random sensor ID.
- Tap **Program** to write in the new created sensor ID to the sensor. The tool starts programming until the programming process is finished.

 Note: If Auto is selected, the TPMS Relearn operation needs to be performed after programming all required sensors.

### Method 2 – Manual Create

This function allows users to manually enter sensor ID. Users can enter the random ID or the original sensor ID, if it is available.

1. Select the wheel which needs to be programmed on the tool, place the sensor close to the TPMS antenna of the tool, and tap **Manual**.
2. Use the on-screen virtual keypad to input a random or original (if available) sensor ID and tap **OK**.

 Note: Do not enter the same ID for each sensor.

3. Follow the on-screen prompts to write in the sensor ID to the sensor.

 Notes:

- If a random ID is entered, please perform the TPMS Relearn function after programming is finished. If the original ID is entered, there is no need to perform Relearn function.
- If a vehicle does not support Learn function, please select the Manual option to enter the original sensor ID manually, or trigger the original sensor at the activation screen to get its information, before programming the sensor.

### Method 3 – Copy by Activation

This function allows users to write in the retrieved original sensor data to the specific sensor. It is used after the original sensor is triggered.

1. From the activation screen, select the specific wheel position and trigger the original sensor. After the information is retrieved, it will be displayed on the screen.
2. Place a sensor close to the TPMS antenna of the tool, and tap **Replication**.
3. Tap **Program** to write in the copied sensor data to the sensor.

 Note: Once programmed with Replication, the specific sensor can be installed in the wheel directly to be mounted on the vehicle and the TPMS warning light will turn off.

### Method 4 – Copy by OBD

This function allows users to write in the retrieved sensor information to the specific sensor after performing **Reading ECU ID**.

If the user had performed both the **Read ECU ID** function and the trigger



function, the tool will use the sensor information retrieved by the trigger function to program the sensor as default priority.

### 5.3 TPMS Learning

This function is used to write the newly programmed sensor IDs into the vehicle's ECU for sensor recognition.

Relearn operation applies only when the newly programmed sensor IDs are different from the original sensor IDs stored in the vehicle's ECU.

There are three ways available for Relearn: Static Learning, Self-Learning and Relearn by OBD.

#### Method 1 – Static Learning

Static learning requires the vehicle to be put into learning / retraining mode, and then follow the on-screen prompts to complete it.

#### Method 2 – Self-Learning

For some vehicles, the learning function can be completed by driving. Refer to the on-screen learning steps to do the operation.

#### Method 3 – OBD Relearning

This function allows the diagnostic tool to write the sensor IDs to the TPMS module.

To perform relearn by OBD, firstly activate all sensors, and then use the tool to complete the learning steps following the on-screen instructions.

### 5.4 TPMS Diagnosis

This function enables user to write sensor IDs to vehicle, read IDs from vehicle, read/clear TPMS codes, read TPMS live data etc.



Note: This function varies from vehicle to vehicle. While performing this function, a proper connection between the vehicle and the tool is required.

## 6 Maintenance

This module provides an easy dial to quickly access the most commonly performed service functions as follows.

- Oil Reset Service
- Electronic Parking Brake Reset
- Steering Angle Calibration
- ABS Bleeding
- TPMS (Tire Pressure Monitor System) Reset
- Gear Learning
- IMMO Service
- Injector Coding
- Battery Maintenance System (BMS) Reset
- Diesel Particulate Filter (DPF) Regeneration
- Electronic Throttle Position Reset
- Gearbox Matching
- AFS (Adaptive Front-lighting System) Reset
- Sunroof Initialization
- Suspension Calibration

### 6.1 Oil Reset Service

This function enables you to reset the oil service for the engine oil life system, which calculates an optimal oil life change interval depending on the vehicle driving conditions and weather events.

It needs to be performed in the following cases:

1. If the service lamp is on, run car diagnostics first for troubleshooting. After that, reset the driving mileage or driving time, so as to turn off the service lamp and enable a new driving cycle.
2. If the service lamp is not on, but you have changed the engine oil or electric appliances that monitor oil life, you need to reset the service lamp.

### 6.2 Electronic Parking Brake Reset

This function enables you to reset the brake pad after replacing the brake pad.

It needs to be performed in the following cases:

1. The brake pad and brake pad wear sensor are replaced.

2. The brake pad indicator lamp is on.
3. The brake pad sensor circuit is short, which is recovered.
4. The servo motor is replaced.

### **6.3 Steering Angle Calibration**

This function enables you to reset the steering angle, after replacing the steering angle position sensor, replacing steering mechanical parts (such as steering gearbox, steering column, end tie rod, steering knuckle), performing four-wheel alignment, or recovering car body.

### **6.4 ABS Bleeding**

This function allows you to perform various bi-directional tests to check the operating conditions of Anti-lock Braking System (ABS).

It needs to be performed in the following cases:

1. When the ABS contains air.
2. When the ABS computer, ABS pump, brake master cylinder, brake cylinder, brake line, or brake fluid is replaced.

### **6.5 Tire Pressure Monitor System Reset**

This function enables you to quickly look up the tire sensor IDs from the vehicle's ECU, reset tire pressure and turn off the tire pressure MIL.

It needs to be performed in the following cases:

Tire pressure is too low, tire leaks, tire pressure monitoring device is replaced or installed, tire is replaced, tire pressure sensor is damaged, and tire is replaced for the car with tire pressure monitoring function.

### **6.6 Gear Learning**

This function enables you to perform tooth learning for the car, to turn off the MIL.

It needs to be performed in the following cases:

1. After the engine ECU, crankshaft position sensor, or crankshaft flywheel is replaced.
2. The DTC 'tooth not learned' is present.

### **6.7 IMMO Service**

This function enables you to perform the anti-theft key matching function, so that the immobilizer control system on the car identifies and authorizes remote

control keys to normally use the car.

It needs to be performed in the following cases:

When the ignition switch key, ignition switch, combined instrument panel, ECU, BCM, or remote control battery is replaced.

### **6.8 Injector Coding**

This function enables you to write injector actual code or rewrite code in the ECU to the injector code of the corresponding cylinder, so as to more accurately control or correct cylinder injection quantity.

It needs to be performed in the following cases:

After the ECU or injector is replaced.

### **6.9 Battery Maintenance System Reset**

This function enables you to perform a resetting operation on the monitoring unit of vehicle battery, in which the original low battery fault information will be cleared and battery matching will be done.

It needs to be performed in the following cases:

1. The main battery is replaced.
2. The battery monitoring sensor is replaced.

### **6.10 Diesel Particulate Filter (DPF) Regeneration**

This function enables you to clear PM (Particulate Matter) from the DPF filter through continuous combustion oxidation mode (such as high temperature heating combustion, fuel additive or catalyst reduce PM ignition combustion) to stabilize the filter performance.

It needs to be performed in the following cases:

1. The exhaust back pressure sensor is replaced.
2. The PM trap is removed or replaced.
3. The fuel additive nozzle is removed or replaced.
4. The catalytic oxidizer is removed or replaced.
5. The DPF regeneration MIL is on and maintenance is performed.
6. The DPF regeneration control module is replaced.

### **6.11 Electronic Throttle Position Reset**

This function enables you to make initial settings to throttle actuators and returns the *learned* values stored on ECU to the default state. Doing so can accurately

control the actions of regulating throttle (or idle engine) to adjust the amount of air intake.

### **6.12 Gearbox Matching**

This function enables you to complete the gearbox self-learning to improve gear shifting quality.

It needs to be performed in the following cases:

When the gearbox is disassembled or repaired.

### **6.13 AFS (Adaptive Front-lighting System) Reset**

This function enables you to initialize the adaptive headlamp system.

### **6.14 Sunroof Initialization**

This function enables you to set the sunroof lock off, closed when it rains, sliding / tilting sunroof memory function, temperature threshold outside the car etc.

### **6.15 Suspension Calibration**

This function enables you to adjust the height of the body.

It needs to be performed in the following cases:

1. When replacing the body height sensor, or control module in the air suspension system.
2. When the vehicle height is incorrect.

### **6.16 EGR Adaption**

This function is used to learn the EGR (Exhaust Gas Recirculation) valve after it is cleaned or replaced.

### **6.17 Windows Calibration**

This feature is designed to perform door window matching to recover ECU initial memory, and recover the automatic ascending and descending function of power window.

### **6.18 Seats Calibration**

This function is applied to match the seats with memory function that are replaced and repaired.

### **6.19 Tyre Reset**

This function is used to set the size parameters of the modified or replaced tire.

### **6.20 Language Change**

This function is used to change the system language of the vehicle central

control panel.

### **6.21 A/F Reset**

This function is applied to set or learn Air/Fuel ratio parameters.

### **6.22 Coolant Bleed**

Use this function to activate the electronic water pump before venting the cooling system.

### **6.23 Transport Mode**

In order to reduce power consumption, the following functions may be disabled, including limiting the vehicle speed, not waking up the door opening network, and disabling the remote control key, etc. At this time, the transport mode needs to be deactivated to restore the vehicle to normal.

### **6.24 AdBlue Reset (Diesel Engine Exhaust Gas Filter)**

After the diesel exhaust treatment fluid (car urea) is replaced or filled up, urea reset operation is required.

### **6.25 NOx Sensor Reset**

NOx sensor is a sensor used to detect the content of nitrogen oxides (NOx) in engine exhaust. If the NOx fault is re-initialized and the NOx catalytic converter is replaced, it is necessary to reset the catalytic converter learned value stored in the engine ECU.

### **6.26 Stop/Start Reset**

This function is used to open or close the automatic start-stop function via setting the hidden function in ECU (provided that the vehicle has a hidden function and supported by hardware).

## 7 Update

This module enables you to update the diagnostic software & App and frequently used software.

### 7.1 Update Diagnostic Software & APP

Go to **Update** on the Job Menu to enter the update center.

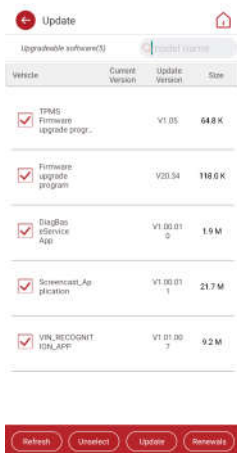

Tap **Update** to start downloading.

Once download is finished, the software packages will be installed automatically.

### 7.2 Renew Subscription

If the software subscription is due or expires, the system will prompt you to renew your subscription.

Tap **Renewals** on the bottom of the screen to enter the payment screen.

1. Tap **Subscription Renewal Card** (\*need to buy it from the local dealer where you purchased the tool).
2. Input the 24-digit pin code of Subscription Renewal Card and then tap **Submit** to finish the renewal.
3. Go to update center to update the diagnostic software.

## 8 Videoscope

This module allows you to check those unseen parts of engine, fuel tank, braking system. It needs to work with the compatible Videoscope device (sold separately).

For more details, please refer to the User Manual included with the module.

## 9 Personal Center

This function allows users to manage personal information and VCI.

### 9.1 VCI

This option allows you to manage all your activated VCI devices.

### 9.2 Activate VCI

This item lets you activate the VCI connector in case you ignore the Activate VCI step in process of the product sign-up.

### 9.3 Fix Connector Firmware

Use this item to upgrade and fix diagnostic firmware. During fixing, please do not cut power or switch to other interfaces.

### 9.4 My Order

This item allows you to check the status of all your orders.

### 9.5 Subscription Renewal Card

This item is used to check the status of the subscription renewal card.

### 9.6 Profile

Use this item to view and configure personal information.

### 9.7 Change Password

This item allows you to modify your login password.

### 9.8 Diagnostic Software Clear

This item allows you to hide/clear the diagnostic software that is not frequently used.



Note: Removing software may completely delete the software from the tool. If some software is not used and the tool runs out of space, you can use this feature to remove it. To re-download it, go to **Software Update -> Available**.



### 9.9 Settings

It enables you to make some application settings and view software version information etc.

#### 1. Units of Measurement

It is designed to configure the measurement unit. Metric System and English System are available.

#### 2. Shop Information

This option lets you define your print information.

After inputting, tap **Save**. Once you saved the print information, it will be entered automatically in the “More Information” box every time you save the diagnostic report.

#### 3. Clear Cache

This option allows you to clear the App cache. Clearing the cache will restart the App.

#### 4. About

The software version information and disclaimer are included.

#### 5. Diagnostic Software Auto Update

This option is used to set whether automatic update function is ON.

#### 6. Login/Logout

To logout the current user ID, tap **Logout**.

To login the system again, tap **Login**.

## 10 FAQ

### **1. How to save power?**

1. Please turn off the screen while the tool keeps idle.
2. Set a shorter standby time.
3. Decrease the brightness of the screen.
4. If WLAN connection is not required, please turn it off.
5. Disable GPS function if GPS service is not in use.

### **2. Communication error with vehicle ECU?**

Please confirm:

1. Whether the VCI connector is correctly connected.
2. Whether ignition switch is ON.
3. If all checks are normal, send vehicle year, make, model and VIN number to us using Feedback feature.

### **3. Failed to enter into vehicle ECU system?**

Please confirm:

1. Whether the vehicle is equipped with this system.
2. Whether the VCI connector is correctly connected.
3. Whether ignition switch is ON.
4. If all checks are normal, send vehicle year, make, model and VIN number to us using Feedback feature.

### **4. What to do if the language of vehicle diagnostic software does not match the system language?**

1. English is the default system language of the tool. After the system language is set to the preference language, please go to the update center to download the vehicle diagnostic software of the corresponding language.
2. If the downloaded diagnostic software is still displayed in English, it indicates that the software of the current language is under development.

## **FCC Warning:**

Any Changes or modifications not expressly approved by the party responsible for compliance could void the user's authority to operate the equipment.

This device complies with part 15 of the FCC Rules. Operation is subject to the following two conditions:

- (1) This device may not cause harmful interference.
- (2) this device must accept any interference received, including interference that may cause undesired operation.

Note: This equipment has been tested and found to comply with the limits for a Class B digital device, pursuant to part 15 of the FCC Rules. These limits are designed to provide reasonable protection against harmful interference in a residential installation. This equipment generates uses and can radiate radio frequency energy and, if not installed and used in accordance with the instructions, may cause harmful interference to radio communications. However, there is no guarantee that interference will not occur in a particular installation. If this equipment does cause harmful interference to radio or television reception, which can be determined by turning the equipment off and on, the user is encouraged to try to correct the interference by one or more of the following measures:

- Reorient or relocate the receiving antenna.
- Increase the separation between the equipment and receiver.
- Connect the equipment into an outlet on a circuit different from that to which the receiver is connected.
- Consult the dealer or an experienced radio/TV technician for help.

The device has been evaluated to meet general RF exposure requirement. The device can be used in portable exposure condition without restriction.

## **ISED Warning:**

This device contains licence-exempt transmitter(s)/receiver(s) that comply with Innovation, Science and Economic Development Canada's licence-exempt RSS(s). Operation is subject to the following two conditions:

(1) This device may not cause interference.

(2) This device must accept any interference, including interference that may cause undesired operation of the device.

L'émetteur/récepteur exempt de licence contenu dans le présent appareil est conforme aux CNR d'Innovation, Sciences et Développement économique Canada applicables aux appareils radio exempts de licence. L'exploitation est autorisée aux deux conditions suivantes :

1) L'appareil ne doit pas produire de brouillage;

2) L'appareil doit accepter tout brouillage radioélectrique subi, même si le brouillage est susceptible d'en compromettre le fonctionnement.

This transmitter must not be co-located or operating in conjunction with any other antenna or transmitter. Cet émetteur ne doit pas être colocalisé ou fonctionner en conjonction avec une autre antenne ou un autre émetteur.

The device has been evaluated to meet general RF exposure requirement. The device can be used in portable exposure condition without restriction.

Le matériel a été évalué pour répondre aux exigences générales d'exposition aux radiofréquences. Le dispositif peut être utilisé dans des conditions d'exposition portables illimitées.

### **Warranty**

THIS WARRANTY IS EXPRESSLY LIMITED TO PERSONS WHO PURCHASE SMARTSAFE PRODUCTS FOR PURPOSES OF RESALE OR USE IN THE ORDINARY COURSE OF THE BUYER'S BUSINESS.

SMARTSAFE electronic product is warranted against defects in materials and workmanship for one year from date of delivery to the user.

This warranty does not cover any part that has been abused, altered, used for a purpose other than for which it was intended, or used in a manner inconsistent with instructions regarding use. The exclusive remedy for any automotive meter found to be defective is repair or replacement, and SMARTSAFE shall not be liable for any consequential or incidental damages.

Final determination of defects shall be made by SMARTSAFE in accordance with procedures established by SMARTSAFE. No agent, employee, or representative of SMARTSAFE has any authority to bind SMARTSAFE to any affirmation, representation, or warranty concerning SMARTSAFE automotive meters, except as stated herein.

### **Disclaimer**

The above warranty is in lieu of any other warranty, expressed or implied, including any warranty of merchantability or fitness for a particular purpose.

### **Purchase Order**

Replaceable and optional parts can be ordered directly from your SMARTSAFE authorized tool supplier. Your order should include the following information:

- Order quantity
- Part number
- Part name

THANK YOU FOR CHOOSING SMARTSAFE!

If you have any questions or comments please contact:

SHENZHEN SMARTSAFE TECH CO.,LTD.

Addr: 3F, Building B, Qiao'an Technology Industrial Park, Guanlan, Longhua  
New District, Shenzhen

Zip: 518110

Tel: 86-755-89589916

<http://www.newsmartsafe.com>

**Statement:**

SMARTSAFE reserves the rights to make any change to product designs and specifications without notice. The actual object may differ a little from the descriptions in the manual in physical appearance, color and configuration. We have tried our best to make the descriptions and illustrations in the manual as accurate as possible, and defects are inevitable, if you have any question, please contact local dealer or after-sale service center of SMARTSAFE, SMARTSAFE does not bear any responsibility arising from misunderstandings.