

Copyright Information

Copyright © 2021 by SHENZHEN SMARTSAFE TECH CO.,LTD. All rights reserved. No part of this publication may be reproduced, stored in a retrieval system, or transmitted in any form or by any means, electronic, mechanical, photocopying, recording or otherwise, without the prior written permission of SMARTSAFE.

Neither SMARTSAFE nor its affiliates shall be liable to the purchaser of this unit or third parties for damages, losses, costs, or expenses incurred by purchaser or third parties as a result of: Accident, misuse, or abuse of this unit, or unauthorized modifications, repairs, or alterations to this unit, or failure to strictly comply with SMARTSAFE operating and maintenance instructions. SMARTSAFE shall not be liable for any damages or problems arising from the use of any options or any consumable products other than those designated as Original SMARTSAFE Products or SMARTSAFE Approved Products by SMARTSAFE.

All information, specifications and illustrations in this manual are based on the latest information available at the time of printing. SMARTSAFE reserves the right to make changes at any time without prior written or oral notice.

Trademark Information

SMARTSAFE is a registered trademark of SHENZHEN SMARTSAFE TECH CO.,LTD. in China and other countries. All other SMARTSAFE trademarks, service marks, domain names, logos, and company names referred to in this manual are either trademarks, registered trademarks, service marks, domain names, logos, company names of SMARTSAFE or are otherwise the property of SMARTSAFE or its affiliates. In countries where any of the SMARTSAFE trademarks, service marks, domain names, logos and company names are not registered, SMARTSAFE claims other rights associated with unregistered trademarks, service marks, domain names, logos, and company names. Other products or company names referred to in this manual may be trademarks of their respective owners. You may not use any trademark, service mark, domain name, logo, or company name of SMARTSAFE or any third party without permission from the owner of the applicable trademark, service mark, domain name, logo, or company name. You may contact SMARTSAFE by visiting the website at www.newsmartsafe.com, or writing to SHENZHEN SMARTSAFE TECH CO.,LTD., 3310, Building 11, Tianan Cloud Park, Bantian Street, Longgang District, Shenzhen, Guangdong, China, to request written permission to use Materials on this manual for purposes or for all other questions relating to this manual.

To avoid personal injury, property damage, or accidental damage to the product, please read all the information in this chapter before using the product.

Operation Specification For New Energy Vehicle Safety Maintenance

1. Identification of high voltage components: The orange wiring harnesses of the vehicle are all high voltage wires.
2. High voltage parts: power battery pack, high voltage distribution box, on-board charger, driving motor controller and DC-DC assembly, electric power assembly, integrated compressor, PTC heater, maintenance switch.
3. When repairing the high voltage system, the power supply of the vehicle must be OFF (and the vehicle is in the non-charging state), and remove the maintenance switch; After the emergency maintenance switch is removed, it shall be kept by full-time guardianship personnel, and ensure that no one will plug it in during the maintenance process.

 *Notice: When the high voltage distribution box needs to be repaired or replaced, remove the positive and negative high voltage connectors connected to the battery pack carefully, and wrap the exposed wires with electrical tape to avoid electric shock.*

4. Five minutes after turning off the emergency maintenance switch, use a multimeter to measure the high voltage circuit and ensure that there is no power before checking and repairing the high voltage system.
 - 4.1 Measure the voltage between the positive electrode of the battery pack and the body to preliminarily determine whether there is electric leakage. If the voltage is greater than or equal to 50V, it indicates that there is a leakage in the battery pack. Stop the operation immediately.
 - 4.2 When using a multimeter to measure high voltage, select the correct measurement range. The accuracy level of the multimeter should not be lower than 0.5, and the measurement range should not be less than or equal to 600V. Please follow "One-hand Operation" principle;
 - 4.3 One pen line of the multimeter is equipped with an insulated alligator clip (the voltage is required to be 3KV; the overcurrent capacity is greater than 5A). During measuring, clamp the clip to a terminal of the circuit first, and then connect the other pen to the terminal to measure the reading. Only hold the pen with one hand during each measurement; do not touch the metal part of the pen during measurement.
5. The maintenance switch shall not be assembled during low-voltage debugging. In high-voltage debugging, the full-time guardian shall instruct the assembly and maintenance switch.

6. High voltage debugging must be carried out under the premise of good low voltage debugging, so as to determine whether the battery has leakage. If there is leakage, it should be checked in time, and high voltage debugging cannot be carried out.
7. During disassembling and installing the power battery pack assembly; wrap the high-voltage wiring harness connector connected to the high-voltage distribution box with insulation tape. Do not damage the wiring harness during disassembly and installation to avoid electric shock.
8. During repairing or replacing parts that pass through the sheet metal holes of the body, such as high-pressure wiring harnesses and tubing, pay attention to check whether the protection with the sheet metal of the body is normal to avoid the wear of the wiring harnesses and tubing



NOTES

1. Maintain a safe environment for vehicle testing at all times.
2. Do not operate the detection equipment while driving the vehicle to avoid distraction and causing an accident.
3. Before starting the engine, you should pull the handbrake, especially the front wheel, and put the shift lever in neutral (manual transmission) or [P] gear (automatic transmission) so as not to start the engine and make the vehicle injure people.
4. The exhaust gas from the engine contains a variety of toxic compounds (such as hydrocarbons, carbon monoxide, nitrogen oxides, etc.), which will lead to slow response and even serious personal injury or death. The vehicle under test should be parked in a well-ventilated place during operation.
5. Take extreme care when working around ignition coils, distributor caps, ignition lines and plugs. These components generate dangerous voltages when the engine is running.
6. To avoid damaging the testing equipment or generating incorrect data, please ensure that the vehicle battery is fully charged and that the connection of the vehicle diagnostic seat is clean and safe.
7. The vehicle battery liquid contains sulfuric acid, sulfuric acid is corrosive to the skin, so you should avoid direct contact between the battery liquid and the skin during the operation, especially do not splash it into the eyes, and do not put it close to the fire.
8. Keep clothing, hair, hands, tools, testers, etc. away from running or hot engine parts.
9. Please use the charger that comes with it. The Company will not be

responsible for any damage or loss caused by the use of other chargers not designated by the Company.

10. Keep the testing equipment dry and clean, away from gasoline, water and grease. When necessary, clean the surface of the equipment with a clean cloth coated with a mild detergent.

11. All internal repairs to test equipment must be performed by authorized maintenance organizations or authorized technicians. Attempting to disassemble or modify the device will void the warranty.

This manual uses the following conventions.

PROMPT

Prompt information provides helpful information such as additional operation instructions, tips, and suggestions. Example:

 *Prompt: The VIN code is usually located on the driver's side, in the lower right corner of the front windshield. The exact location varies from car to car. A VIN code is generally composed of 17 standard characters. The VIN code characters can contain the uppercase letters A to Z and the numbers 1 to 0, but the letters I, O, and Q are not usually used to avoid mispronunciation.*

WARNING

It indicates an imminent hazard that, if unavoidable, will result in death or serious injury to the operator or bystander. Example:

 *Warning: Reading a fault code during troubleshooting a vehicle is only a small step in the diagnostic process. The vehicle fault code is only used as a reference, and parts cannot be replaced directly on the basis of the given fault code definition. Each fault code has a set of test procedures, and the service technician must strictly follow the operating instructions and procedures described in the vehicle service manual to confirm the root of the fault.*

DANGER

It indicates an imminent hazard that, if unavoidable, will result in death or serious injury to the operator or bystander. Example:

 *Danger: You must drive the vehicle in order to perform troubleshooting. Please find someone else to help you. It is dangerous to drive and operate diagnostic equipment at the same time, which can cause severe traffic accidents.*

Table of Contents



1. Packing List	1
2. Product Introduction	6
2.1 Overview	6
2.2 iSmartEV P01 Tablet	6
2.3 iSmartEV BOX Detection box	8
2.4 Technical parameters	8
3. Initial Use	10
3.1 Charge the Tablet	10
3.2 Turn On/Off	10
3.3 Network Connection	10
3.4 Registration and Upgrade	11
4. Getting Started	14
4.1 Main interface and bottom navigation bar	14
4.2 Communication settings	15
5. Battery Pack Detection	17
6. Quick Charging Port Detection	22
7. Vehicle Detection	25
7.1 Intelligent Detection	25
7.2 Manual Selection	25
8. Endoscope	37
9. Current Clamp	37
10. ADAS Calibration	37
10.1 Activate ADAS calibration function	37
10.2 Start calibration	38
11. Special Functions	41
11.1 A/F Reset	41
11.2 Electronic Parking Brake Reset	41
11.3 Oil Reset Service	41
11.4 Steering Angle Calibration	41

11.5 Battery Maintenance System Reset	41
11.6 ABS Bleeding	42
11.7 Throttle learning	42
11.8 Tire Pressure Monitor System Reset	42
11.9 Diesel Particulate Filter (DPF) regeneration	43
11.10 Gearbox Matching	43
11.11 Gear Learning	43
11.12 Motor Angle Calibration Diagnosis	43
11.13 Coolant Bleed	43
11.14 Engine Power Balance Monitoring Diagnosis	43
11.15 IMMO Service	44
11.16 High Voltage Battery Diagnostics Diagnosis	44
11.17 Gas Particulate Filter Regeneration Diagnosis	44
11.18 Transport Mode	44
11.19 Tire Reset	44
11.20 Windows Calibration	44
11.21 AdBlue Reset	44
11.22 NOx Sensor Reset	44
11.23 Injector Coding	45
11.24 Airbag Reset	45
11.25 Stop/Start Reset	45
11.26 Sunroof Initialization	45
11.27 Suspension Calibration	45
11.28 Odometer Calibration Diagnosis	45
11.29 Language Change	46
11.30 Intelligent Cruise Control System Diagnosis	46
11.31 AC System Relearn/Initialization Diagnosis	46
11.32 Seats Calibration	46
11.33 AFS (Adaptive Front-lighting System) Reset	46
12. Software upgrade	47
12.1 Upgradable	47
12.2 Downloaded	47
13. Remote diagnosis	49

13.1 Remote diagnosis request	49
13.2 Assist others remotely	50
13.3 Contact list	51
14. Personal center	53
14.1 My connector	53
14.2 Connector activation	53
14.3 Firmware fix	53
14.4 Personal information	54
14.5 Diagnostic unit settings	54
14.6 Diagnostic software clearing	54
14.7 About	55
14.8 Exit the current account	55
15. Detection report	56
16. Other.....	58
16.1 Tablet setting	58
16.2 Diagnostic feedback	60
16.3 File management	61
16.4 Remote control	62
16.5 Browser	62
16.6 System OTA upgrade	62
16.7 Photo album	63
16.8 Screen recording	63
16.9 Player	63
16.10 Mail	63
16.11 Photograph	63
17. Frequently Asked Questions	64
FCC Warning	66
Warranty.....	67

1. Packing List



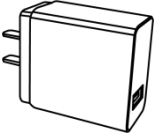

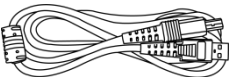
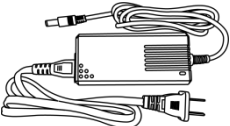





Each machine has the same general accessories, but the product configuration is different for different markets. For details, please consult the local dealer or refer to the packing list delivered randomly with the product.



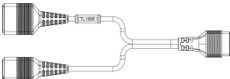

Main Frame and Accessories			
No.	Name	Q'TY	Reference Picture
1	iSmartEV P01 Tablet	1	
2	iSmartEV BOX	1	
3	OBD II Extension Cable	1	
4	Charger (5V 3A)	1	

5	USB Cable (Type-C)	1	
6	USB Cable (Type-B)	1	
7	Power Adapter (12V 5A)	1	
8	Password Envelop	1	-
9	Quick Use Guide	1	-
10	User Manual	1	-
11	Packing List	1	-



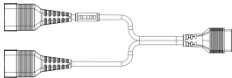

Special Connector for Battery Pack







No.	Name	Q'TY	Reference Picture
1	Special connector for battery pack TL-100R	1	

2	Special connector for battery pack TL-101R	1	
3	Special connector for battery pack TL-102R	1	
4	Special connector for battery pack TL-104Y	1	
5	Special connector for battery pack TL-105R	1	
6	Special connector for battery pack TL-106R	1	
7	Special connector for battery pack TL-107R	1	
8	Special connector for battery pack TL-108Y	1	
9	Special connector for battery pack TL-109Y	1	
10	Special connector for battery pack TL-110B	1	
11	Special connector for battery pack TL-112B	1	

12	Special connector for battery pack TL-113Y	1	
13	Special connector for battery pack TL-114Y	1	
14	Special connector for battery pack TL-126R	1	
15	Special connector for battery pack TL-130R	1	

Battery Pack Jumper and Adapter Cable

No.	Name	Q'TY	Reference Picture
1	Battery pack jumper (Jump-8)	1	
2	Adapter Cable 1	4	
3	Adapter Cable 2	4	
4	Adapter Cable 3	4	

5	Adapter Cable 4	4	
6	Adapter Cable 5	4	
7	Adapter Cable 6	4	
8	Adapter Cable 7	4	
9	Adapter Cable 8	4	
10	Adapter Cable 9	4	

2. Product Introduction

2.1 Overview

iSmartEV P01 New energy vehicle battery pack detector is a professional comprehensive testing equipment for new energy vehicles developed by SmartSafe Company. The equipment supports new energy vehicle testing and vehicle battery pack testing functions, and has integrated professional measurement tools such as oscilloscope, multimeter, insulation testing, current clamp etc. for new energy vehicles.

- Support deep system detection of battery packs of various brands, and support reading of parameters such as the current SOC/SOH, monomer/module voltage, input/output current and power, and battery temperature etc. for battery packs.
- Automatically calculate the total voltage, voltage difference, maximum /minimum voltage and other indicators, and automatically label abnormal data.
- Support new energy vehicle whole vehicle detection, support the reading/cleaning of battery pack fault code, special function, actuation test and other detection functions.

2.2 iSmartEV P01 Tablet

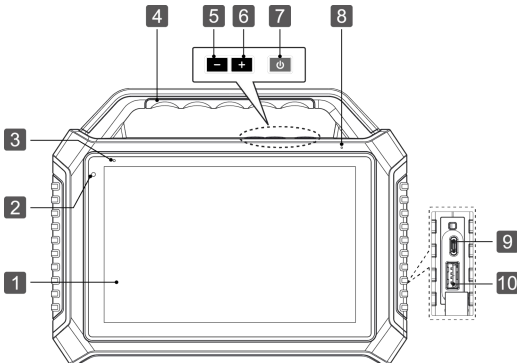

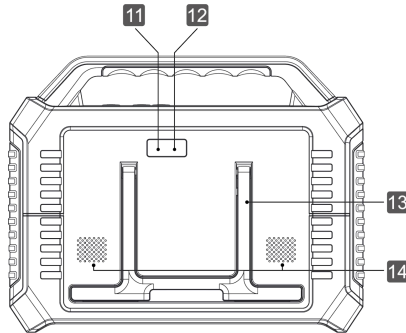

No.	Name and Description
1	10.1-inch touch screen
2	Front facing camera
3	Power indicator light: <i>Red during charging and green after fully charged.</i>
4	Handle
5	Volume -
6	Volume+
7	Power button/screen lock button <ul style="list-style-type: none"> • Press the button for about 3 seconds to start the machine when the power is off. • Press this key to wake up/close the screen when the power is on. • Press the button for more than 3 seconds to select shutdown or restart when the power is on; Press the button for about 8 seconds to force the shutdown.
8	Microphone
9	USB Type-C <ul style="list-style-type: none"> • Used for connecting to power adapter for charging or connecting to computer for data transmission.
10	USB Type-A <ul style="list-style-type: none"> • Used for connecting to USB devices or function expansion

	<i>modules.</i>
11	Flash light
12	Rear camera
13	Holder
14	Loudspeaker

2.3 iSmartEV BOX Detection box

The device is a Vehicle Communication Interface (VCI) device, which is used to connect the vehicle diagnosis seat or battery pack low-voltage signal communication interface for data collection, and then send the data to the host for analysis.

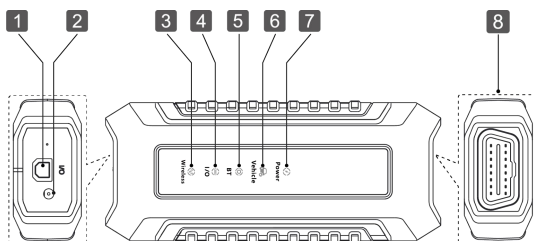

No.	Name and Description
1	USB Type-B
2	DC 12V Power supply jack
3	Wi-Fi indicator
4	USB indicator
5	Bluetooth indicator
6	Vehicle communication indicator
7	Power supply indicator
8	OBD-II port

2.4 Technical parameters

2.4.1 iSmartEV P01

Item	Specification Parameters
Operation System	Android 7.1
CPU	8-core processor, 2.0GHz
Internal Storage	4GB
Storage	128GB
Display Screen	10.1 inch, 1920 * 1200 resolution touch screen
Front Facing Camera	8 million pixels
Rear Camera	13 million pixels
Wi-Fi	2.4GHz/5GHz Wi-Fi
Communication	Wi-Fi, Bluetooth, USB
Battery	3.8V/9360mAH
Working Temperature	0℃ ~45℃
Storage Temperature	-20℃ ~70℃

2.4.2 iSmartEV BOX



Item	Specification Parameters
CPU	Cortex A7 + Cortex-M7
System	Linux
Internal Storage	256M
Storage	8GB
Port	Type B、ODBI-16、DC-IN
Communication	Wi-Fi, Bluetooth, USB
Working Voltage	DC 9~36V
Working temperature	0℃ ~50℃
Storage temperature	-20℃ ~70℃

3. Initial Use

3.1 Charge the Tablet

 **Warning:** Please use the charger that comes with the product for charging. We are not responsible for any damage or economic loss caused by charging with a charger other than the one designated by us.

Please follow the following steps to charge the iSmartEV P01 tablet:

1. Connect one end of the charging cable to the USB port on the charger and the other end to the Type-C port on the host, and connect the charger to the power socket.
2. If the power indicator of the host is red and the battery identifier on the screen is displayed , then the battery is being charged.
3. When the power indicator of the host is green, the charging is complete. In this case, the battery identifier is displayed .

 **Note:**

If the device has not been used for a long time or the battery power of the device is exhausted, you may not be able to turn it on normally when charging. This is a normal phenomenon. Please charge the device for a period of time and then try to start the device.

The battery can be recharged. But because the battery is a wear and tear product, after a long time of use, the standby time of the device will be shortened. So please avoid frequent and repeated charging to prolong the battery life.

3.2 Turn On/Off

3.2.1 Turn On

Press and hold the power button on the device until the screen lights up.

3.2.2 Turn OFF

Press and hold the power button on the device until the shutdown prompt dialog box pops up on the screen, click [Turn off] to shut down the device or click [Restart] to restart the device.

3.3 Network Connection

When using the device for the first time, you need to register a personal account, activate the VCI connector, and upgrade the detection software or APK. In this case, the device must be connected to the Internet. For details on wireless network connection, please refer to chapter 16.1.

3.4 Registration and Upgrade

During the first use, the user needs to follow the following operations:

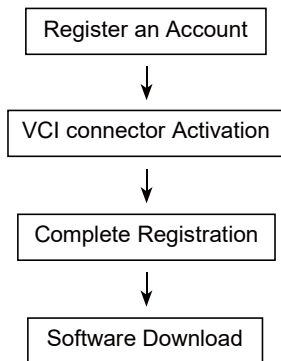

Note: Before registration, ensure that the network connection to the host is normal and stable.

On the main interface, click [Personal Center] -> [Login], and the following dialog box will pop up:

The image shows a user login dialog box titled "用户登录" (User Login). It contains two input fields: "用户名" (Username) and "密码" (Password). Below the fields is a large "登录" (Login) button. At the bottom left, there is a link for "忘记密码" (Forgot Password), and at the bottom right, there is a link for "新用户注册" (New User Registration).

(If you are a new user, follow Section A.)

(If you are registered, please refer to Section B for login.)

(If you forget your password, please refer to Section C to reset it.)

A. If you are a new user, please click [New User Registration] to enter the registration page



In the figure above, fill in the registration information in turn (the item with * is required). After the account information is filled in, click [Register], and the system will enter the interface of connector activation.



Enter the product serial number and activation code. The product serial number and activation code can be obtained from the password envelope in the package box.

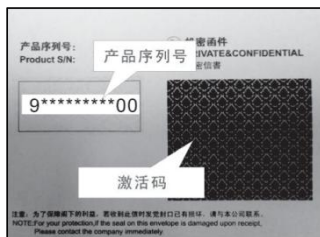

Note: If you skip the activation step here, you can also go to [Personal Center] -> [Connector Activation] to activate after entering.

Click [Activate] to complete the registration.



Click [Confirm] to enter the software upgrade interface.



On the software upgrade page, click [One-click Upgrade] to start downloading. After the download is complete, the system will automatically install the software.

Note: During the upgrade, ensure that the network connection is normal. In addition, due to the large number of software, it may take a long time (depending on the network speed). Please wait patiently.

B. If you have already registered, input the user name and password and click [Login] to enter the account.

Prompt: The device has the user information memory function. If multiple accounts have logged in to the device, click the triangle drop-down button behind the user name input box to select the corresponding account to log in.

C. If you forget the password, please click [Forget Password] and then set the new password according to the prompts on the screen.

4. Getting Started

4.1 Main interface and bottom navigation bar

4.1.1 Main interface

The main interface of iSmartEV P01 mainly includes the following functions modules:









Items	Description
Battery Pack Detection	This function is used for deep system detection of the vehicle battery pack.
Vehicle Detection	Use this function to test the electric control system of the whole vehicle.
Quick Charging Port Detection	This function module needs to be used with iSmartEV FC01 new energy vehicle battery pack detection gun (optional), which can quickly detect the vehicle battery pack.
Special Functions	Use this function for special functions such as vehicle maintenance and adjustment etc.
Detection report	Check and manage the detection report and records.
Software Upgrade	One-click upgrade of battery pack software, model software, operating system, client, and firmware is supported.
Endoscope	The function module works with an endoscope device (optional) to detect invisible or inaccessible parts of the engine, fuel tank and brake system. For details, refer to the user manual delivered with the endoscope device.

Current Clamp	This module works with the new energy current clamp (optional) for AC/DC current test and DC voltage test. For details, refer to the user manual enclosed with the new energy current clamp.
ADAS Calibration	This module works with the specified ADAS calibration tool (purchased separately, e.g., ADAS Mobile) for ADAS (Advanced Driver Assistance System) calibration operations.
Remote Diagnosis	The function module is used to remotely assist the user to diagnose the vehicle.
Personal Center	Check and manage VCI connectors, firmware fix and personal information etc.
Other	Including functional modules such as tablet settings, diagnostic feedback, file management, remote control, browser, system OTA upgrade, photo album, screen recording, player, email and photograph etc. as well as system APP.

4.1.2 Bottom navigation bar

The bottom navigation bar contains the following buttons:

Icon	Name and Function Description
	Browser-click this button the start the browser
	Screenshot-click this button to capture and save the current screen image. The screenshot is saved in the Screenshots folder.
	VCI connection indicator-after the host is successfully connected to the VCI connector, this button lights up in green.
	Backstage Management - Click this button to display a list of recently used application thumbnails. Click on any of the thumbnails to open the corresponding program, hold d the thumbnail to slide it left and right to close the corresponding program.
	Main interface-click to return to the main interface
	Return-click to return to previous page

4.2 Communication settings

The main connection modes of the host and VCI connectors are Wi-Fi communication and USB cable communication.

4.2.1 Wi-Fi communication

The host will prompt the user to register and activate the VCI connector during the first use. Once the activation is complete, the host will automatically match with the VCI connector and establishes a Wi-Fi connection. At this time the VCI connector icon  at the bottom of the host screen lights up and the Wi-Fi indicator of the VCI connector is also on.

4.2.2 USB communication

When the host and VCI connectors are connected through USB cables, the system automatically switches to USB communication mode. At this time the VCI connector icon  at the bottom of the host screen will light up, and the USB indicator of the VCI connector will also light up.

5. Battery Pack Detection

This function is used to check the detailed data and fault information of battery pack, helping users to quickly determine the abnormal status and fault point of battery pack.

⚠ Danger: The personnel who operate the battery pack test must wear protective equipment such as insulation gloves, insulation shoes and goggles. Operating the battery pack without protection can cause a serious electric shock.

1. Start the iSmartEV P01 and click [Battery pack detection] on the main interface.



2. Select the vehicle brand or battery pack brand (You can find it quickly through the search bar in the upper right corner)



3. Select the vehicle model and year.



4. Select the connection method of battery pack.



Note: For cars that support fast charging port detection, the "Fast Charging port detection" interface will be displayed after the connection mode is selected as [Fast Charging port Detection]. See Chapter 6 for specific operation.

A. On-Board Diagnostics(OBD) seat connection

The battery pack of the vehicle was tested by connecting the iSmartEV BOX detection BOX to the OBD diagnosis seat of the vehicle through an OBD extension cable.

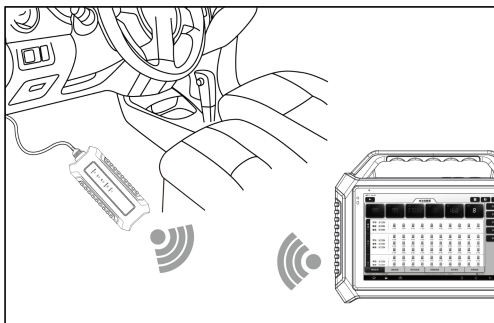

B. Connect special connectors for battery packs

Connect the iSmartEV BOX detection BOX and the low-voltage signal communication interface of the battery pack respectively with the battery pack special connector to test the vehicle battery pack.

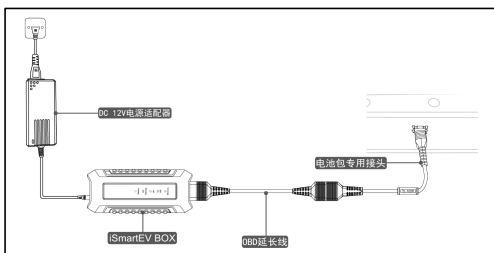

C. Battery pack jumper connection.

According to the wiring diagram prompted by the software, the jump-8 jumper is used to connect the iSmartEV BOX detection BOX and the low-voltage signal communication interface of the battery pack respectively to detect the battery pack of the vehicle.

Note: The picture here is an example only. The connection mode varies with vehicle types. Please connect based on the wiring diagram prompted by the software.

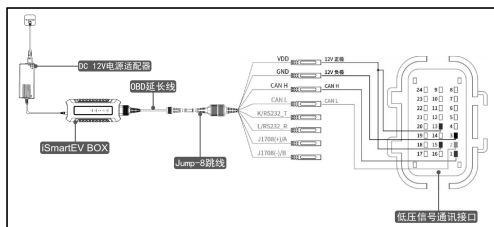

5. After the connection is complete, the device automatically reads and displays the detailed data of the battery pack. Users can determine the abnormal status of the battery pack based on the detection data.



Description for screen buttons:

【Main Interface】	Click to return to the main interface.
【Exit】	Click to exit the current detection process.
【Report】	Click to view/save the detection report of battery pack.
【Refresh】	Click to refresh the current data of battery pack.

Function description:

【Voltage Detection】	Used to display the voltage parameters of each module in the battery pack, and mark the highest/lowest voltage monomer in the battery pack.
【Temperature Detection】	Used to display the temperature parameters of each module and other components in the battery pack, and mark the highest/lowest temperature monomer in the battery pack.
【Battery Pack】	Used to detect the ECU information, overall state, fault

Information】	state and module data in the battery pack, which is convenient for the maintenance personnel to quickly determine the fault point.
【Fault Code Detection】	Used to read the fault code in the current battery pack BMS system.
【Actuation Test】	Used to test whether the execution components in the system can work properly.
【Special Functions】	Used to learn and match the components in the battery pack BMS system.  <i>Note: The specific special functions provided depend on the vehicle type.</i>

6. Quick Charging Port Detection

The function module must be equipped with iSmartEV FC01 new energy vehicle battery pack detection gun (optional), and the battery pack can be quickly detected through the DC quick charging port of new energy vehicle, so as to help the maintenance personnel quickly determine the battery pack fault.

1. On the main interface, click [Quick Charging Port Detection] to enter the quick battery pack detection screen. Make preparations before testing according to the precautions prompted on the interface, and then click [Next].



2. Operate as prompted on the screen, insert the detection gun into the DC quick charging port of the vehicle, and then click [Next].



3. The system starts searching for the detection gun.



4. Select the serial number of the current detection gun for connection.



Note:

- 1) When testing again, the system will automatically connect the detection gun.
- 2) If you need to switch the detection gun, please close the previously connected device and search for the connection again.

5. After the test is complete, you can view the battery pack quick test report. Slide the screen to view more information.



6. Click [Save] to save the quick test report on the host.



7. Click [Share] to generate the two-dimensional code, and scan the two-dimensional code to share the report.



7. Vehicle Detection

This function is mainly used for vehicle detection. Users can use "intelligent detection" to quickly identify vehicle information and enter the system for vehicle detection, or manually select models and systems for detection.

7.1 Intelligent Detection

Use "Intelligent detection" to quickly identify vehicle information and vehicle detection, without manual selection of vehicle type.

Click [Vehicle Detection] -> [Intelligent Detection] on the main interface to enable the intelligent detection function of vehicles.

Some models may not be able to identify the vehicle information through the intelligent detection function. In this case, the following dialog box will pop up for the user to scan or manually input the vehicle VIN code.



7.2 Manual Selection

1. Click [Vehicle Detection] on the main interface to enter the vehicle brand selection interface.



2. Click the vehicle brand to be tested to enter the model version information interface (for example: BYD).

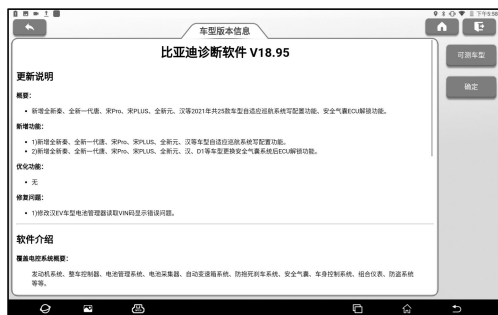

Screen button description:

【Vehicle models that can be tested】	Click to view the current vehicle models that can be tested
【Confirm】	Click to enter the next step

3. Select the model and year of the vehicle to be tested (for example: BYD 2018 E5 Travel version).



【Automatic selection】	Clicking this item will automatically identify the model, year and VIN code of the vehicle under test. After confirming the information, click [Correct] to go to the next step.
【Manual selection】	Click this item to manually select the model and year, and click [Confirm] to go to the next step.

4. Select the test options you want to perform.



Note: Different models will have different systems and common special functions, users can choose the required options for testing.

7.2.1 Quick test

This feature is used to quickly detect the vehicle and output the vehicle health report directly (this will only be displayed if the vehicle testing software supports this function).



On the screen for selecting test options, click "Quick Test". The system starts to scan each system for fault codes and displays specific scan results.



Systems with fault codes are displayed on the screen in red font with the specific number of fault codes. The system without faults (green) is displayed as "Normal".

Screen Button Description:

【 ▲ 】	If there are too many fault codes, click this button to hide the fault codes of the current system so that you can view
-------	---

	the fault codes of other systems. To view details about the fault code, click ▼
【 ➤ 】	Click to enter the system and choose to perform other functions. Please refer to Chapter 7.2.2 for details.
【Compare the results】	<p>Click to select the report before maintenance. By comparing the test reports before and after maintenance, the maintenance technician can clearly understand whether the fault codes found before maintenance have been completely cleared after maintenance.</p> <p> Note: Before performing this function, please ensure that:</p> <ul style="list-style-type: none"> · The pre-maintenance inspection report of the current test vehicle has been saved; and · Repairs have been carried out on the basis of the inspection report before maintenance, and the code has been cleared. Otherwise there will be no difference between the reports before and after the maintenance.
【Report】	<p>Click to save the current fault report as the detection report.</p> <div data-bbox="290 764 668 1208" data-label="Form"> </div> <p>Click ▼ to select the report type from the drop-down list, then enter the details and click [OK].</p> <p> Note: Diagnostic reports can be classified into pre-maintenance report, post-maintenance report, and</p>

	<p>diagnostic scan (if no comparison is required, you can select "Diagnostic Scan"). The device has the report comparison function, so you need to select a correct report type when saving reports. By comparison, maintenance technicians can clearly understand whether the fault codes found before diagnosis have been completely cleared after maintenance.</p> <p>Enter the name of tester and customer, and then click [OK] to enter the report details view page.</p> <p>On the report details page, click [Save] to save the report. All test reports are stored in the "Main Interface" -> "Test Report" tab.</p>
<p>【Help】</p>	<p>Click to view the cause analysis of the fault code.</p>
<p>【Code clearing】</p>	<p>Click to clear all the fault codes.</p> <p> Note: For general models, please strictly follow the conventional sequence: read the fault code first, then clear the fault code, test run, read the fault code again for verification, repair the vehicle, clear the fault code, test run again to confirm that the fault code does not appear.</p>

7.2.2 System selection

Users can use this function to manually select the vehicle electronic control system for testing.

On the screen for selecting test options, click "Select System" to enter the following page:



Select the electronic control system to be tested. The function selection page is

displayed. "ECM", for example.

 Note: The test menu may be different for different models.



A. Version information

This function is used to read the ECU version information of the current vehicle.

B. Read fault code

This function is used to read the fault code existing in the current car ECU, and help maintenance personnel quickly understand the cause of vehicle failure.

Click [Read Fault Code] on the test function selection page, and the screen will display the following detection results.



 **Warning:** Reading a fault code while troubleshooting a vehicle is only a small step in the diagnostic process. The vehicle fault code is only used as a reference, and parts cannot be replaced directly on the basis of the given fault code definition. Each fault code has a set of test procedures, and the maintenance technician must strictly follow the operating instructions and procedures described in the vehicle maintenance manual to confirm the root of the fault.

Screen button description:

【Freeze frame】	If the button is highlighted, the frame is frozen. The freezing frame function is to record the values of some specific data streams at the moment when the car breaks down for verification.
【Help】	Click to view the possible cause of the fault code.
【Relevant search】	Click to search for a specific explanation of the fault code online.
【Report】	Save the current test result as a test report. All test reports are stored in the "Main Interface" -> "Test Report" tab.

C. Clear fault code

This function is used to clear fault codes stored in the ECU of the system under test.

In the test function selection page, click [Clear fault code], the system will pop up a dialog box of confirming clearing, click [Yes] to confirm the clearing of the fault code.

 Note: For general models, please operate in strict accordance with the conventional sequence: read the fault code first, then clear the fault code in the test run, read the fault code again for verification, repair the vehicle, clear the fault code, and confirm the fault code does not appear in the test run again.

D. Read data stream

This function is mainly used to read and display the car ECU real-time operation data and parameters. By observing these real-time data streams, the mechanic can gain insight into the overall performance of the vehicle and provide guidance for vehicle maintenance.

 **Danger:** If you must drive the vehicle while performing troubleshooting, please ask someone else to help you. Driving and operating diagnostic equipment at the same time is dangerous and can cause serious traffic accidents.

Click [Read Data Stream] on the test function selection page, and the system enters the data stream selection page.



Screen button description:

【Current page】	Select all data stream options on the current page.
【Select all】	Select all data stream options.
【Cancel selection】	Click to cancel all the selected data stream options.
【Confirm】	Confirm the current operation.

Click [Confirm], the system will display the dynamic data of the selection.

