

Copyright Information

Copyright © 2021 by SHENZHEN SMARTSAFE TECH CO.,LTD. All rights reserved. No part of this publication may be reproduced, stored in a retrieval system, or transmitted in any form or by any means, electronic, mechanical, photocopying, recording or otherwise, without the prior written permission of SMARTSAFE.

Neither SMARTSAFE nor its affiliates shall be liable to the purchaser of this unit or third parties for damages, losses, costs, or expenses incurred by purchaser or third parties as a result of: Accident, misuse, or abuse of this unit, or unauthorized modifications, repairs, or alterations to this unit, or failure to strictly comply with SMARTSAFE operating and maintenance instructions. SMARTSAFE shall not be liable for any damages or problems arising from the use of any options or any consumable products other than those designated as Original SMARTSAFE Products or SMARTSAFE Approved Products by SMARTSAFE.

All information, specifications and illustrations in this manual are based on the latest information available at the time of printing. SMARTSAFE reserves the right to make changes at any time without prior written or oral notice.

Trademark Information

SMARTSAFE is a registered trademark of SHENZHEN SMARTSAFE TECH CO.,LTD. in China and other countries. All other SMARTSAFE trademarks, service marks, domain names, logos, and company names referred to in this manual are either trademarks, registered trademarks, service marks, domain names, logos, company names of SMARTSAFE or are otherwise the property of SMARTSAFE or its affiliates. In countries where any of the SMARTSAFE trademarks, service marks, domain names, logos and company names are not registered, SMARTSAFE claims other rights associated with unregistered trademarks, service marks, domain names, logos, and company names. Other products or company names referred to in this manual may be trademarks of their respective owners. You may not use any trademark, service mark, domain name, logo, or company name of SMARTSAFE or any third party without permission from the owner of the applicable trademark, service mark, domain name, logo, or company name. You may contact SMARTSAFE by visiting the website at www.news-smartsafe.com, or writing to SHENZHEN SMARTSAFE TECH

CO.,LTD., 3310, Building 11, Tianan Cloud Park, Bantian Street, Longgang District, Shenzhen, Guangdong, China, to request written permission to use Materials on this manual for purposes or for all other questions relating to this manual.

This manual uses the following conventions.

In this manual, we refer to low voltage and high voltage as **LV** and **HV** for short.

To avoid personal injury, property damage, or accidental damage to the product, please read all information in this chapter before using the product.

Operating Regulation and Requirements for HV Equipment





- (1) Please read this manual carefully and operate the equipment in accordance with relevant guidelines and safety regulations.
- (2) During maintenance, it is required to wear necessary safety protection articles with a voltage resistance level greater than 1000V.
- (3) When disassembling, connecting and operating HV appliances and equipment, attention shall be paid to whether the protection of sheet metal on the vehicle body is normal to avoid wear.
- (4) When installing connectors and terminals of HV components, please ensure that the connectors are properly installed and confirm that connection is reliable.
- (5) During maintenance, please try to use one hand.
- (6) When using digital power, please keep the station dry, bright, and ventilated to prevent electric shock accident caused by the damp environment
- (7) In case of abnormal accident or fire, operators shall immediately cut off HV and LV circuits, evacuate personnel, and extinguish the fire with the fire extinguisher and fire sand under the condition of ensuring their own safety.
- (8) During power output of digital power, please do not operate the equipment or connect the cable harness with power on.
- (9) Improper use of digital power may cause personal injury.

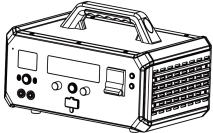

Contents

1. Packing List	1
2. Product Introduction	3
2.1 Overview	3
2.2 iSmartEV DP750	3
3. Technical Parameters	7
4. Equipment Operation	9
4.1 Equipment Startup	9
4.2 LV Output	9
4.3 HV Output	10
5. APP Operation	12
5.1 APP Launching	12
5.2 Bluetooth Button	14
5.3 LV Output	14
5.4 HV Output	15
5.5 Exit	15
6. Equipment Protection	17
6.1 Power Input Protection Mechanism	17
6.2 LV Output Protection Mechanism	17
6.3 HV Output Protection Mechanism	17
FCC Warning	19
Warranty	20

1. Packing List

The following accessories are for reference only. Please consult from the local agency or check the package list supplied with this equipment together.

Main Unit and Accessories			
NO.	Name	Q'TY	Reference Picture
1	iSmartEV DP750	1	
2	AC Power Cord	1	
3	HV Extension Cable	1	
4	HV Wire (Alligator Clip-Fits)	1	

5	HV Jumper Cable (4mm Banana Plug)	1	
6	LV Wire (Alligator Clip-Fits)	1	 (Black)
	LV Wire (Alligator Clip-Fits)	1	 (Red)
7	Certification	1	-
8	User Manual	1	-
9	Packing list	1	-

2. Product Introduction

2.1 Overview

iSmartEV DP750 Adjustable Digital Power Supply for automobile maintenance is a dual-output switching DC stabilized voltage supply developed by SmartSafe Company for both new energy vehicles and fuel vehicles. This product has stable current output, excellent performance indicators, and a variety of protection mechanisms. It is a smart digital power supply dedicated to auto repair, which is safe and easy to use, and supports Bluetooth control.

2.2 iSmartEV DP750

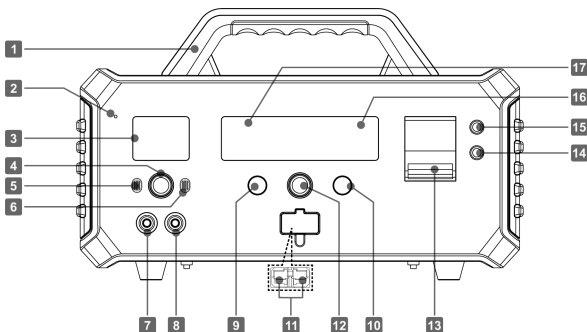

Front View

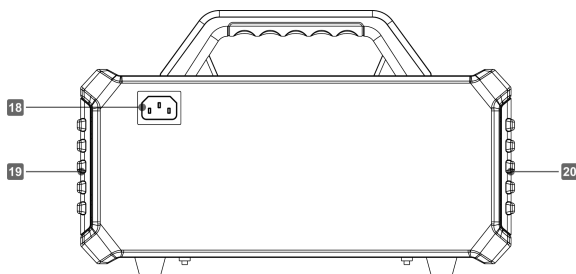

Rear View

No.	Name and Description
1	Handle
2	Buzzer Hole The buzzer will keep sounding when the HV output.
3	Display Area for LV Value Display the current LV output value.
4	LV ON/OFF Button Turn on/off LV output. Under LV output, the LED light (green) of the button is always on; When the LV is not output, the LED light (green) of the button is off.
5	Button of 12V Voltage Press this button to switch to the gear of 12V output voltage.
6	Button of 24V Voltage Press this button to switch to the gear of 24V output voltage.
7	Positive Electrode of LV Output Port (Red)
8	Negative Electrode of LV Output Port (Black)
9	Adjusting Knob for HV Current This knob is used to adjust the set HV current value. The current can be adjusted from 0 to 5A.
10	Adjusting Knob for HV Voltage This knob is used to adjust the set HV value. The voltage can be adjusted from 250~750V.

11 HV Output Port

It includes HV positive and negative electrode interface, a dustproof cover, and fool-proof and anti-reverse connection design.

12 HV ON/OFF Button

Start/Stop HV output. Under HV output, the LED light (orange) of the button is always on; When the HV is not output, the LED light (orange) of the button is off.

13 Circuit Breaker

Push the circuit breaker handle up to turn on the power switch of the equipment, and pull the handle down to turn off the power switch of the equipment.

14 Bluetooth Indicator

After the equipment is powered on, the Bluetooth indicator is always on, and the indicator will continue to flash after establishing a bluetooth connection with the external detection equipment.

15 Power Indicator

After connecting the power supply and pushing up the circuit breaker handle of the equipment to turn on the power switch of the equipment, this indicator will be on.

16 Display Area for HV Voltage Value

When HV output is not started, the current voltage set is displayed. When HV output is started, the actual output voltage is

displayed.

17 Display area for HV Current Value

The current set voltage is displayed when the high-voltage output is not started, and the actual output voltage is displayed after the high-voltage output is started.

18 Power Supply Input

19 Air Vent for Heat Dissipation

Air vent of cooling fan, with a dust screen.

20 Air Inlet for Heat Dissipation

Air inlet of cooling fan, with a dust screen.

3. Technical Parameters

Technical Indexes		
Power Supply Input	AC 100~240V@16A	
Power	3200W Max	
HV Parameters	Voltage Range	250~750V
	Current Range	0~5A
	Voltage Sampling Accuracy	0.1V
	Current Sampling Accuracy	0.1A
	Output Protection	Current-limiting protection, short-circuit protection, undervoltage protection, overvoltage protection, and overtemperature protection
	Input Protection	Overvoltage protection, short-circuit protection, and undervoltage protection
	Insulation Impedance	Input-output: DC1000V 10MΩ Min (Ambient temperature) Input-earth: DC1000V 10MΩ Min (Ambient temperature) Output-earth: DC1000V 10MΩ Min (Ambient temperature)

	Insulation and Resisting Voltage	Input-output: 2000Vac 50Hz (2828Vdc) 1 minute Input-earth: 2000Vac 50Hz (2828Vdc) 1 minute Output-earth: 2000Vac 50Hz (2828Vdc) 1 minute
LV Parameters	Output Voltage	DC 12V/24V (switch with buttons)
	Output Current	1A
	Output Protection	Short-circuit protection
Environment	Working Temperature	-10~65°C
	Storage Temperature	-40~70°C
	Working Environment Humidity	5~95% Relative humidity (no condensation)
Dimension		315x223x191mm

4. Equipment Operation

4.1 Equipment Startup

- (1) Pull down the circuit breaker handle.
- (2) After confirming that voltage of input power supply is correct, connect two ends of the power cord to the power socket and the power input respectively.
- (3) Push up the circuit breaker handle to switch on the power switch.

Note: After the equipment is powered on for the first time, the default LV output is 12V, and the default HV output is 250V 1A.

4.2 LV Output

- (1) Select the required voltage range and verify that the voltage displayed in the upper voltage display area is correct.
- (2) Insert a red LV test wire into the positive electrode of the LV output, and connect the other end to the positive electrode of the device to be tested; Insert the black LV test wire into the negative electrode of the LV output, and connect the other end to the negative electrode of the device to be tested.
- (3) After pressing the LV ON/OFF button, the LED light (green) of the button is always on, and the digital power supplies power to the device under test according to the set voltage value.
- (4) If it is required to stop the LV output, press the LV ON/OFF button again. The LED light of the button (green) will be off, and the digital power will close the LV output.

Note: The voltage cannot be adjusted during the LV output of the equipment; If it is required to adjust the voltage, please stop the LV output of the equipment and set it again.

4.3 HV Output

- (1) Rotate the HV current adjusting knob and the HV voltage adjusting knob to set the required current and voltage values.
- (2) Remove the dust-proof cover of the HV output port, and insert one end of the HV extension cable into the HV output port (with a fool-proof anti-reverse insertion design, the positive and negative signs on the plug are consistent with the positive and negative signs on the output port before inserting)

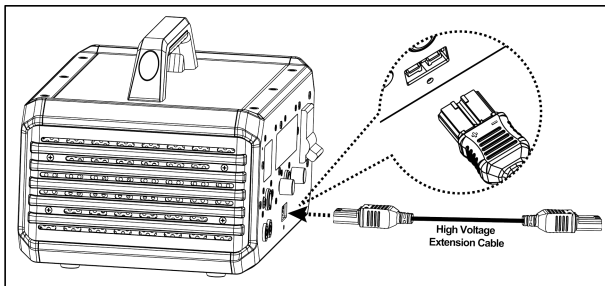

- (3) Select the corresponding high-voltage test wire (alligator clip-fits HV wire or banana plug HV jumper cable) as needed. Connect one end of the test wire to the HV extension cable, connect the red wire at the other end of the test wire to the positive pole of the device under test, and the black wire at the other end to the negative pole of the device under test.

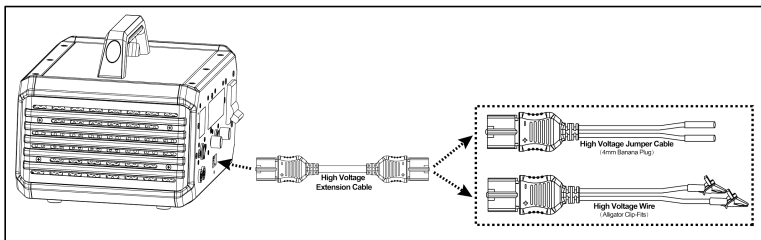

- (4) After pressing the HV ON/OFF button, the LED light (orange)

of the button is always on, the buzzer keeps sounding, and the digital power supply supplies power to the device under test according to the set voltage value.

Note: The voltage and current cannot be adjusted during the HV output of the equipment; If it is required to adjust the voltage and current, stop the HV output of the equipment and set them again.

(5) If it is required to stop the HV output, press the HV ON/OFF button again. The LED light of the button (orange) will be off, and the digital power supply will close the HV output.

Note: When not using the HV output function of digital power supply, it is advised to cover the dust-proof cover to protect the HV output interface and prevent accidental touch.

5. APP Operation

In addition to operating directly on the main unit, iSmartEV DP750 can also be used with other detection devices (such as iSmartEV P01) to operate via Bluetooth wireless connection.

5.1 APP Launching

- (1) Tap **Digital Power** on the detection device to launch the APP.
- (2) After the APP is started, the safety prompt page of "Operating Regulation and Requirements for HV Equipment" is displayed.

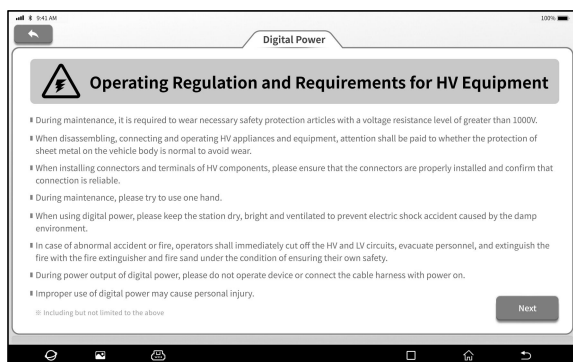

- (3) Tap **Next** to enter the operation interface of digital power supply.

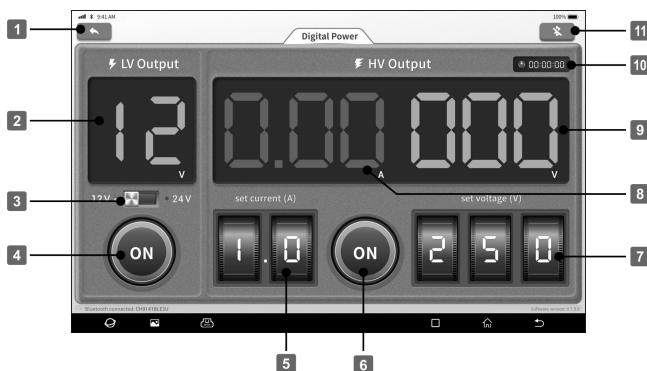

No.	Name and Description
1	Exit Tap this button to exit the APP.
2	Display Area for LV Value Display the current LV output value.
3	LV Setting Button Tap this button to switch the LV gear, including gears of 12V and 24V.
4	LV ON/OFF Button Start/Stop LV output.
5	HV Current Adjusting Knob Slide digitals up and down to set the HV output current.
6	HV ON/OFF Button Start/Stop HV output.
7	HV Voltage Adjusting Knob Slide digitals up and down to set the HV output voltage.
8	Display Area for HV Current Value Display the actual output current value of the HV output port.
9	Display Area for HV Value Display the actual output voltage value of the HV output port.
10	Duration of HV Test After pressing the HV ON/OFF button, the timing indicator will be on and the timing will start. The unit of duration is h/m/s.
11	Bluetooth Button Tap this button to view or set the Bluetooth.

5.2 Bluetooth Button

(1) Tap the Bluetooth button in the upper right corner (the icon is shown as  when Bluetooth is not connected) to pop up the device selection window, and select the serial number of the current digital power supply for connection.

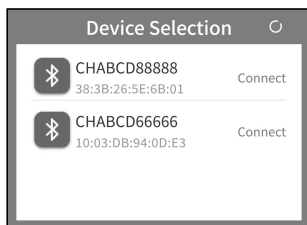

(2) After the Bluetooth is connected, "Bluetooth connected. Synchronizing data..." is displayed on the screen, and the Bluetooth icon is shown as  in the upper right corner.

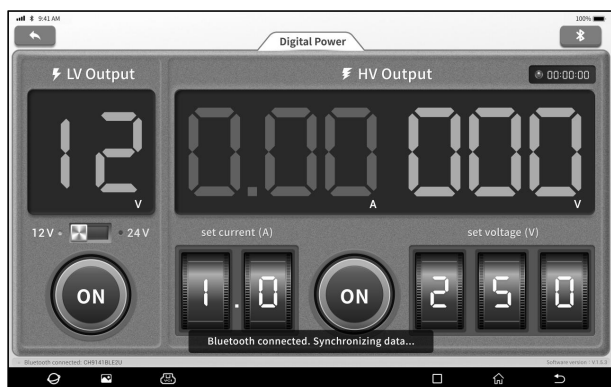

(3) After data synchronization, settings and operations can be performed on both the detection device and the digital power supply, subject to the final operation.

5.3 LV Output

(1) Tap the "LV Setting Button" to switch the voltage gear.

(2) Tap the "LV ON/OFF Button", and the digital power supply will supply power to the device under test according to the set voltage value.

(3) If it is required to stop the LV output, Tap the "LV ON/OFF Button" again.

5.4 HV Output

(1) Slide the "HV Current Adjustment Knob" and "HV Voltage Adjustment Knob" up and down to set the HV current and voltage value respectively, and then tap the "HV ON/OFF Button".

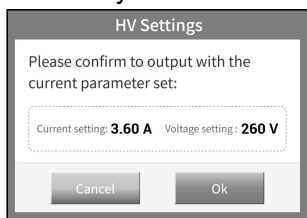

(2) The pop-up window prompts the current setting parameters. Tap **OK** after checking the parameters and confirming that the HV harness is connected normally.



(3) At this time, the buzzer continue to sound, and the digital power supply will supply power to the device under test according to the set parameters.

(4) If it is required to stop the HV output, tap the "HV ON/OFF Button" again.

5.5 Exit

Tap  in the upper left corner of the screen to exit the APP. If the digital power supply is in the output state, Tap the  button and "Digital power output, exit or not" is displayed on the popup of the screen, and Tap **Yes** to confirm exit.

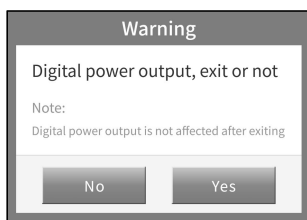

Note: Digital power supply output is not affected after exiting the APP. The digital power output can be turned off only after the "LV ON/OFF button" and "HV ON/OFF button" are turned off.

6. Equipment Protection

6.1 Power Input Protection Mechanism

The iSmartEV DP750 protects the input circuit through a circuit breaker. When the fault protection is triggered, the circuit breaker will automatically cut off the power supply of the equipment.

6.2 LV Output Protection Mechanism

When the LV part triggers fault protection, the digital power supply will automatically cut off the output and prompt the corresponding fault code, and return to the default state. The fault information is described in the following table:

Fault name	Fault Code	Handling Mechanism (recommended)
Short-circuit protection	E01	Stop output immediately, and "Check the equipment" is displayed

6.3 HV Output Protection Mechanism

When the HV part triggers fault protection, the digital power supply will automatically cut off the output and prompt the corresponding fault code, and return to the default state. The fault information is described in the following table:

Fault Name	Fault Code	Handling Mechanism (Recommended)
AC Overvoltage	E01	Check input connections and AC voltage
AC Undervoltage	E02	Check input connections and AC voltage
Output Overvoltage	E03	Stop output immediately, and "Check the equipment" is displayed
Output Undervoltage	E04	No risk to the module. Determine by yourself according to the equipment safety.

Output Overcurrent	E05	Stop output immediately, and "Check the equipment" is displayed
Output Short-circuit	E06	Stop output immediately, and "Check the equipment" is displayed
Overtemperature Protection	E07	Stop output immediately, and "Check the equipment" is displayed
Hardware Fault	E08	Stop output immediately, and "Check the equipment" is displayed
No Equipment Connected	E09	No risk. Determine by yourself according to the equipment safety.
Equipment Polarity Reverse	E10	Stop output immediately, and "Check the equipment" is displayed
PFC derating Caused by Overtemperature	E11	No risk. Check the working environment temperature of the equipment.
Fan Derating Caused by Overtemperature	E12	No risk. Check for fan noise of the equipment.
Derating at a Higher Temperature	E13	No risk. Check the working environment temperature of the equipment.

FCC Warning

Changes or modifications not expressly approved by the party responsible for compliance could void the user's authority to operate the equipment.

This device complies with Part 15 of the FCC Rules. Operation is subject to the following two conditions:

- (1) this device may not cause harmful interference, and
- (2) this device must accept any interference received, including interference that may cause undesired operation.

This transmitter must not be co-located or operating in conjunction with any other antenna or transmitter.

Note: This equipment has been tested and found to comply with the limits for a Class B digital device, pursuant to Part 15 of the FCC Rules. These limits are designed to provide reasonable protection against harmful interference in a residential installation. This equipment generates, uses, and can radiate radio frequency energy, and if not installed and used in accordance with the instructions, may cause harmful interference to radio communications.

However, there is no guarantee that interference will not occur in a particular installation. If this equipment does cause harmful interference to radio or television reception, which can be determined by turning the equipment off and on, the user is encouraged to try to correct the interference by one or more of the following measures:

- Reorient or relocate the receiving antenna.
- Increase the separation between the equipment and receiver.
- Connect the equipment into an outlet on a circuit different from that to which the receiver is connected.
- Consult the dealer or an experienced radio/TV technician for help.

This equipment complies with FCC radiation exposure limits set forth for an uncontrolled environment.

This equipment should be installed and operated with minimum distance 20cm between the radiator & your body.

Warranty

THIS WARRANTY IS EXPRESSLY LIMITED TO PERSONS WHO PURCHASE SMARTSAFE PRODUCTS FOR PURPOSES OF RESALE OR USE IN THE ORDINARY COURSE OF THE BUYER'S BUSINESS.

SMARTSAFE electronic product is warranted against defects in materials and workmanship for one year from date of delivery to the user.

This warranty does not cover any part that has been abused, altered, used for a purpose other than for which it was intended, or used in a manner inconsistent with instructions regarding use. The exclusive remedy for any automotive meter found to be defective is repair or replacement, and SMARTSAFE shall not be liable for any consequential or incidental damages.

Final determination of defects shall be made by SMARTSAFE in accordance with procedures established by SMARTSAFE. No agent, employee, or representative of SMARTSAFE has any authority to bind SMARTSAFE to any affirmation, representation, or warranty concerning SMARTSAFE automotive meters, except as stated herein.

Disclaimer

The above warranty is in lieu of any other warranty, expressed or implied, including any warranty of merchantability or fitness for a particular purpose.

Purchase Order

Replaceable and optional parts can be ordered directly from your SMARTSAFE authorized dealer. Your order should include the following information:

- Order quantity
- Part number
- Part name

Statement:

SMARTSAFE reserves the rights to make any change to product designs and specifications without notice. The actual object may differ a little from the descriptions in the manual in physical appearance, color and configuration. We have tried our best to make the descriptions and illustrations in the manual as accurate as possible, and defects are inevitable, if you have any question, please contact local dealer or after-sale service center of SMARTSAFE, SMARTSAFE does not bear any responsibility arising from misunderstandings.