



## SPECIFICATIONS FOR APPROVAL

Customer Name: \_\_\_\_\_

Product Name: 2.4GHz Antenna

Product Model: \_\_\_\_\_

Part Number: LJW01-17091602-R0A

Write By : Huxuwen

Issued Date: 2021-04-08

### CUSTOMER

ENGINEER R&D DEPT	BUSSINESS DEPT	APPROVAL

### LEJIN

R&D DEPT	ENGINEER DEPT	APPROVAL

REV	MODIFIED DESCRIPTION	DATE	REMARK
V1.0	Initial Draft Release	2021/04/08	



## Index

1. Cover	1
2. Index	2
3. Product Specification	3
4. Test Equipment & Conditions	3
5. Test Report	4
6. Reliability Test	5
7. Assemble type	5
8. Product Drawing	6



### 3.Product Specification

A. Electrical Characteristics	
Frequency	2400MHz ~2500 MHz
VSWR	<2.0
Efficiency	>40%
Impedance	50Ohm
Polarization	Linear
Gain	≥1.0dB
B. Material & Mechanical Characteristics	
Material of Radiator	Metal
Cable Type	N/A
Connector Type	N/A
Dimension	19.0*3.50*3.75(H)mm
C. Environmental	
Operation Temperature	- 20 °C ~ + 70 °C
Storage Temperature	- 30 °C ~ + 85 °C
Humidity	40%~95%

### 4.Test Equipment & Conditions

- 1.Network Analyzers Agilent 8753D/5071C
- 2.HSPA and LTE protocol test set R&S CMW500 -PT
- 3.Communications Test Set Agilent 8960
- 4.3D Chamber Test System

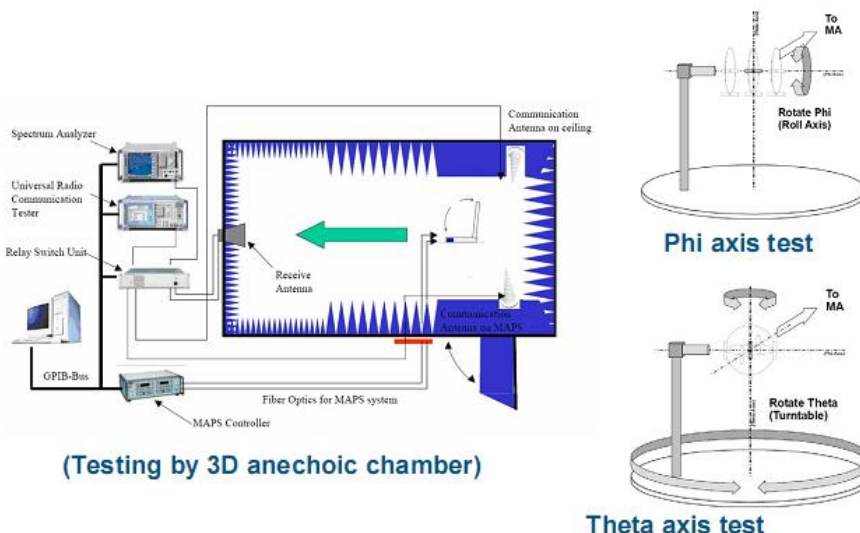

Chart 1 Test topology



## 5. Test Report

### 5.1 Voltage Standing Wave Ratio(VSWR).

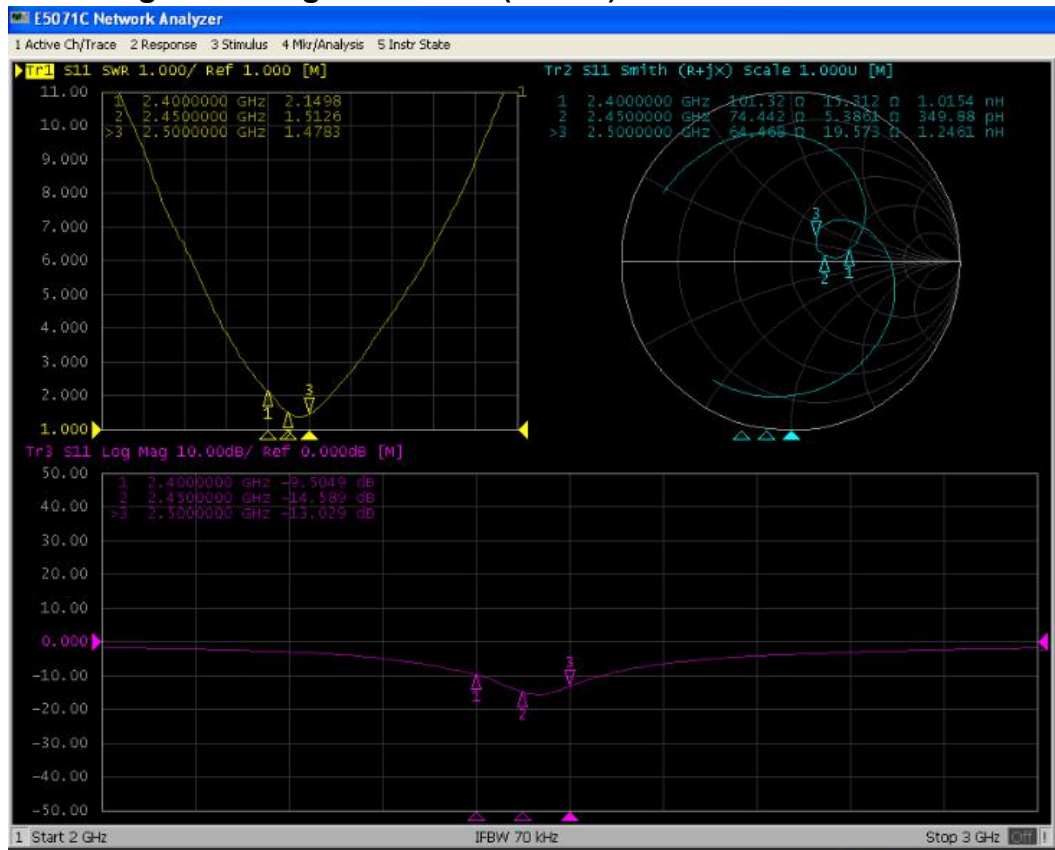
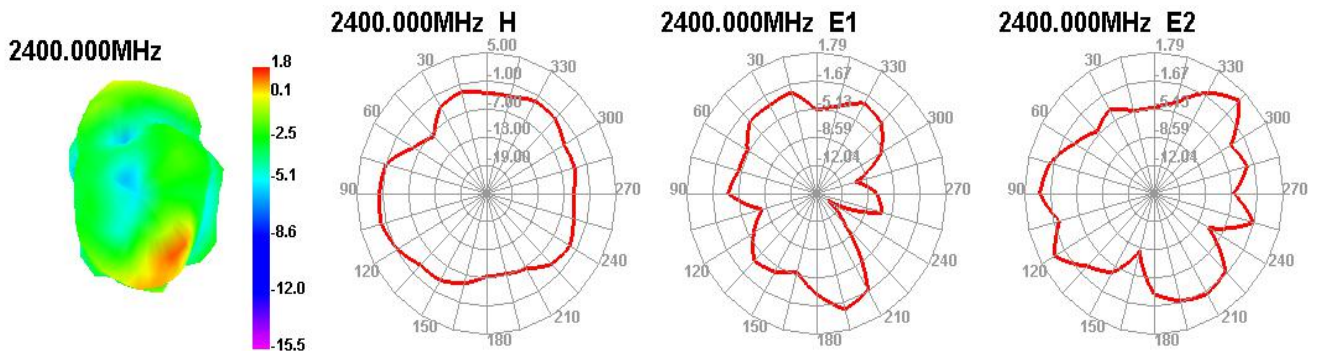

Chart 2 VSWR

### 5.2 Efficient and gain.

Passive Test For WIFI 2.4G	Freq(MHz)	2400	2410	2420	2430	2440	2450	2460	2470	2480	2490	2500
	Effi(%)	42.62	46.84	51.47	55.07	53.54	48.06	51.80	49.38	44.21	42.77	40.64
	Gain(dBi)	0.97	1.04	1.06	1.05	0.94	0.99	1.02	1.19	1.02	0.77	0.36

### 5.3 Radiation pattern.



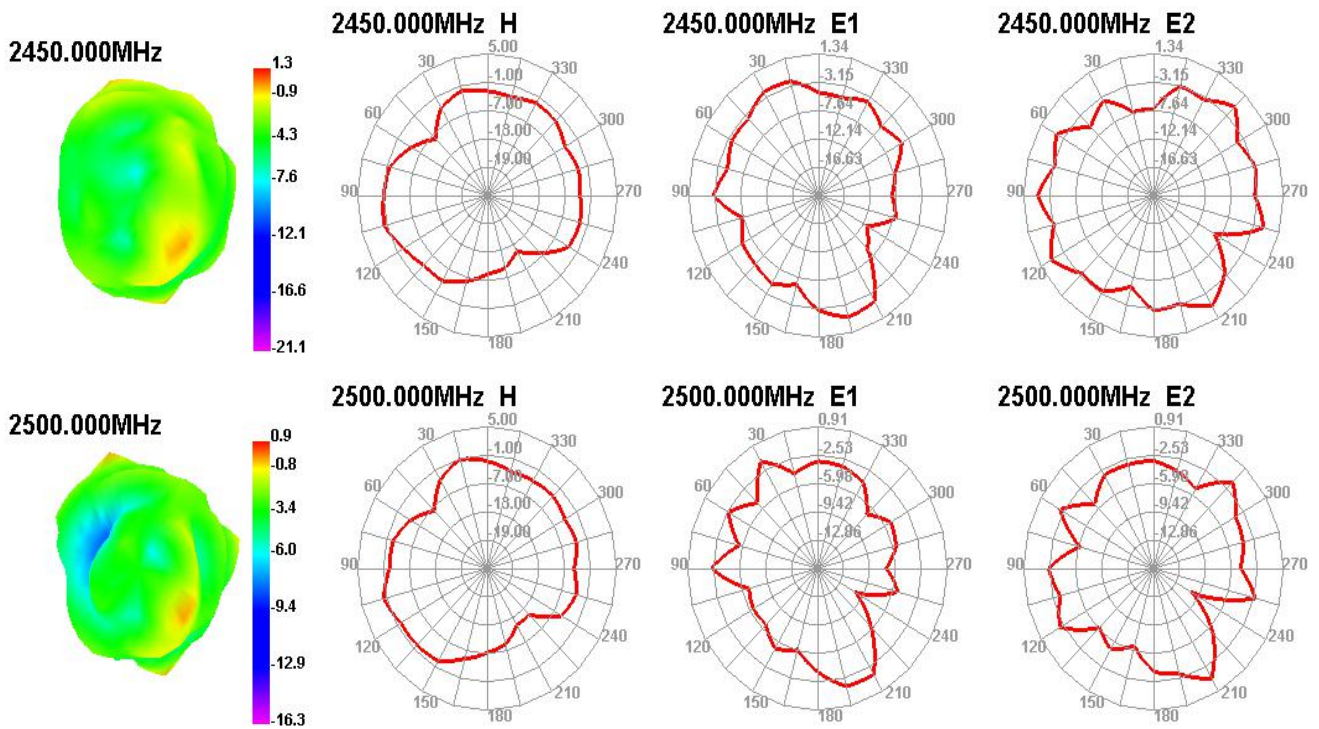

### 6. Reliability Test

Test Item	Test condition	Equipment	Specification	Result
1 Low Temp. Storage Test	Temperature: -30℃ , Time:48hrs Test condition: Placing antenna in a Low/High Temperature Chamber, keep the temp is 25℃ and humidity is 65% for one hour, then step-down the temp. to -30℃ in one hour, store antenna for 44 hours; step-up temp to 25℃, test antenna after 2 hours.	Temp.&Hum. Tester	No material deformation is allowed. Electronic Performance is ok .	PASS
2 High Temp./High Humid Storage Test	Temperature: 85℃ Humidity: 85% RH Time:48hrs Test condition: Placing antenna in a Low/High Temperature Chamber, keep the temp is 25℃ and humidity is 65% for one hour, then step-up the temp. to 80℃ and the humidity up to 85% in one hour, store antenna for 44 hours; step-down temp to 25℃ ,test antenna after 2 hours.	Temp.&Hum. Tester	No material deformation is allowed. Electronic Performance is ok .	PASS
3 Salt-Spray 6 pray Test	Placing antenna in the Salt-Spray Tester ,set the test condition , Temp: 35±2℃ Humidity: 85% NaCl salt spray :5±1%.PH value :6.5~7.2 Testtime:24hours	Salt-Spray Tester	No color change No appear rusting	PASS

### 7. Assemble type(omitted)

### 8. Product Drawing

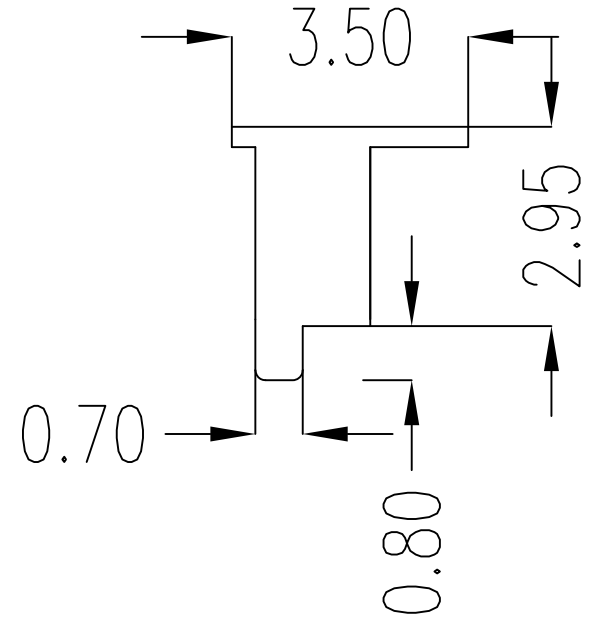
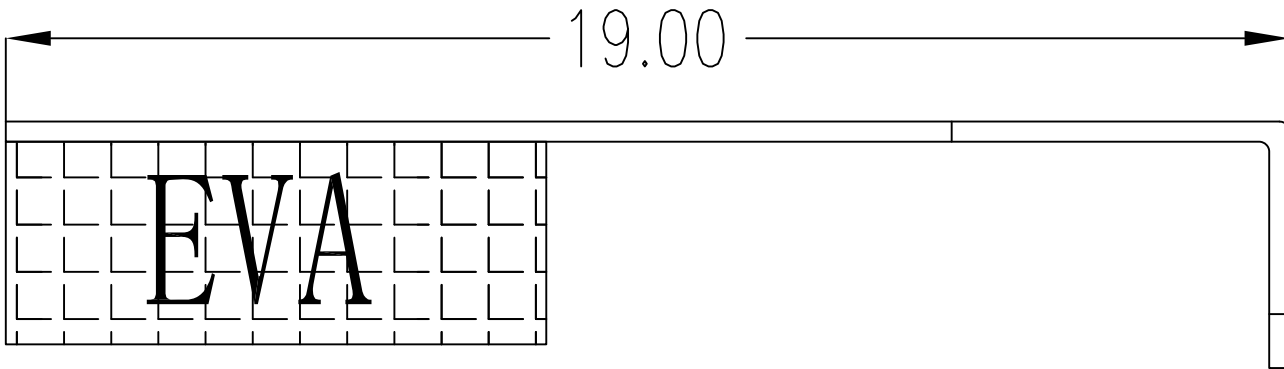
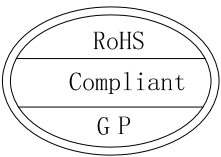

深圳乐进射频科技有限公司  
SHEN ZHEN LEJIN RADIO FREQUENCY CO., LTD

Third Angle	Project	LJW01-17091602-ROA	Date	2017-09-16		
0~10 ±0.05 ○ 0.02	Part Name	2.4G-WIFI-ANT		Designed by		
10~18 ±0.10 ◎ Ø0.03	Part No.			Checked by	MD	
18~30 ±0.12 ⊥ 0.02	Material	洋白铜			RF	
30~40 ±0.15 ∕ 0.04	Treatment	LJW01-17091602-ROA		Approved by		
40~ ±0.20 Angle ±0.5°	Location			Unit	mm	Scale
				FIT	Rev	A

A	New drawing		Date	Remark
Rev	Description	Date	Remark	