

Temperature :	26°C	Relative Humidity :	54%
Pressure :	101kPa	Test Voltage :	AC120V/60Hz
Test Mode :	TX n Mode(20M)		

Frequency (MHz)	6dB bandwidth (MHz)	Limit (kHz)	Result
2412	17.63	500	Pass
2437	17.63	500	Pass
2462	17.62	500	Pass

TX CH 01

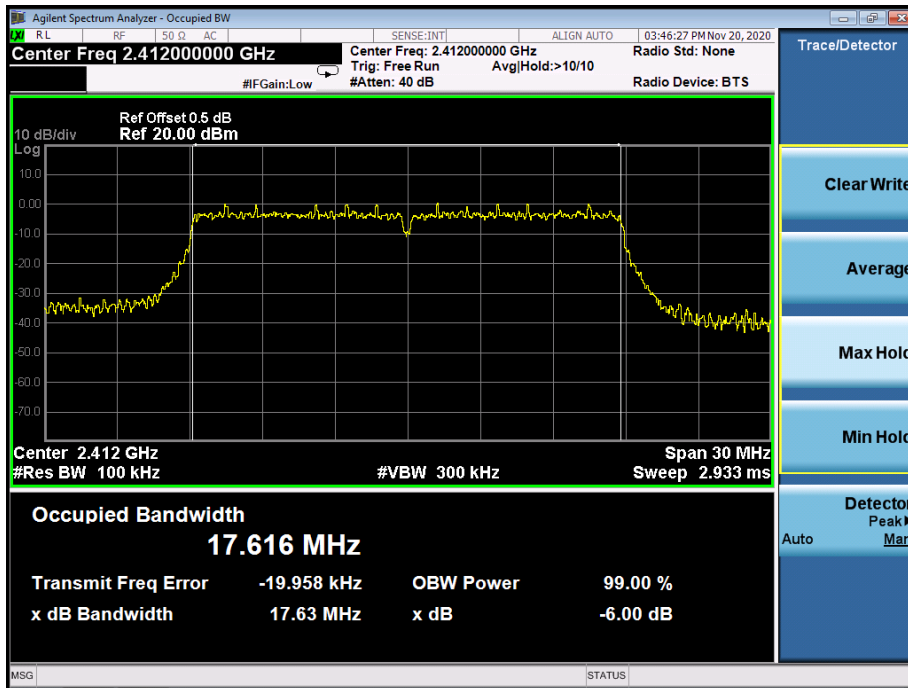
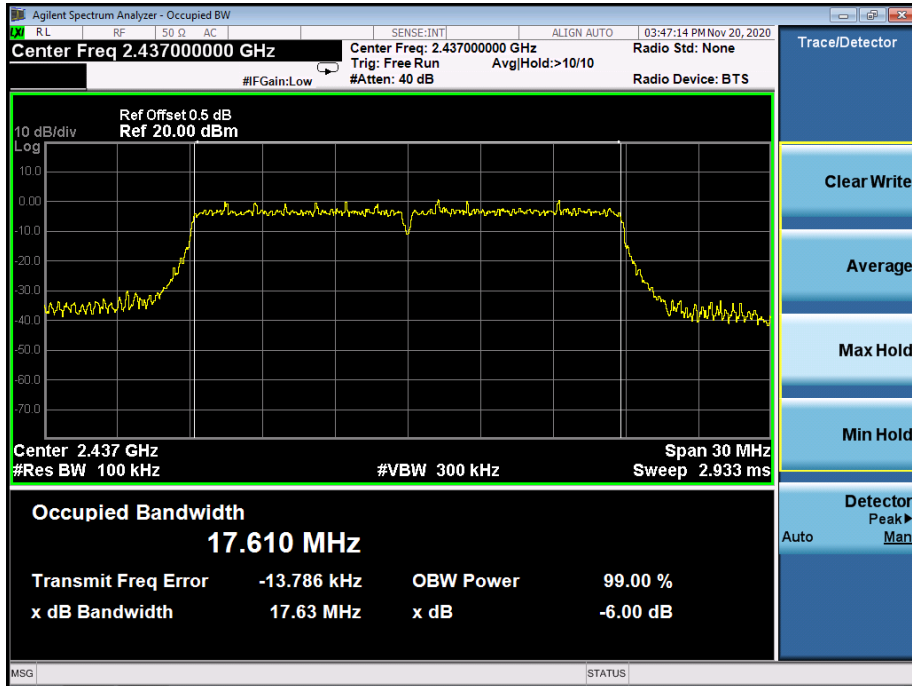
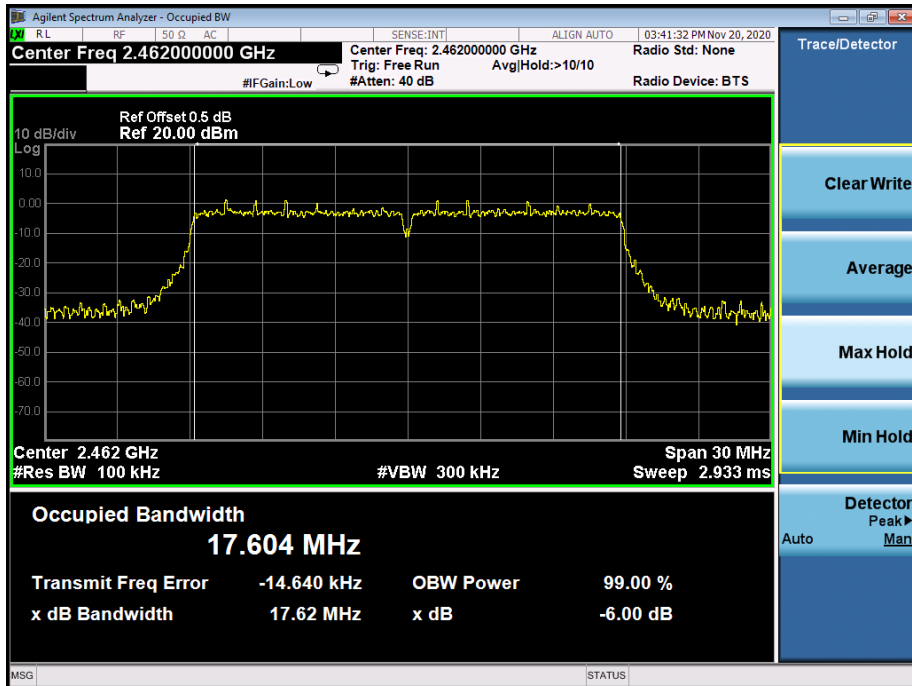

TX CH 06

TX CH 11

Temperature :	26°C	Relative Humidity :	54%
Pressure :	101kPa	Test Voltage :	AC120V/60Hz
Test Mode :	TX n Mode(40M)		

Frequency (MHz)	6dB bandwidth (MHz)	Limit (kHz)	Result
2422	35.87	500	Pass
2437	35.43	500	Pass
2452	35.80	500	Pass

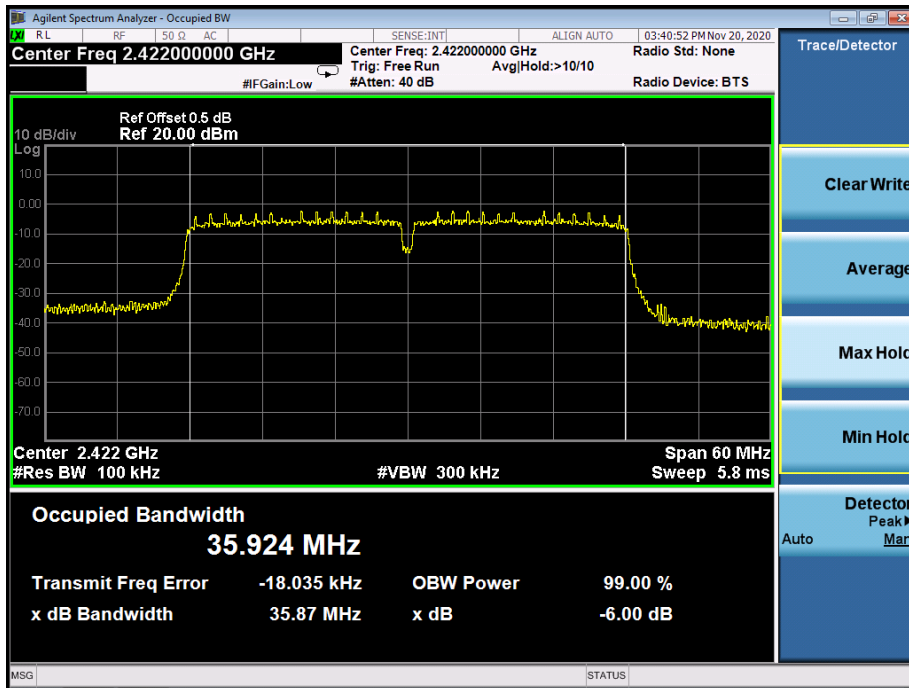
TX CH 03



TX CH 06

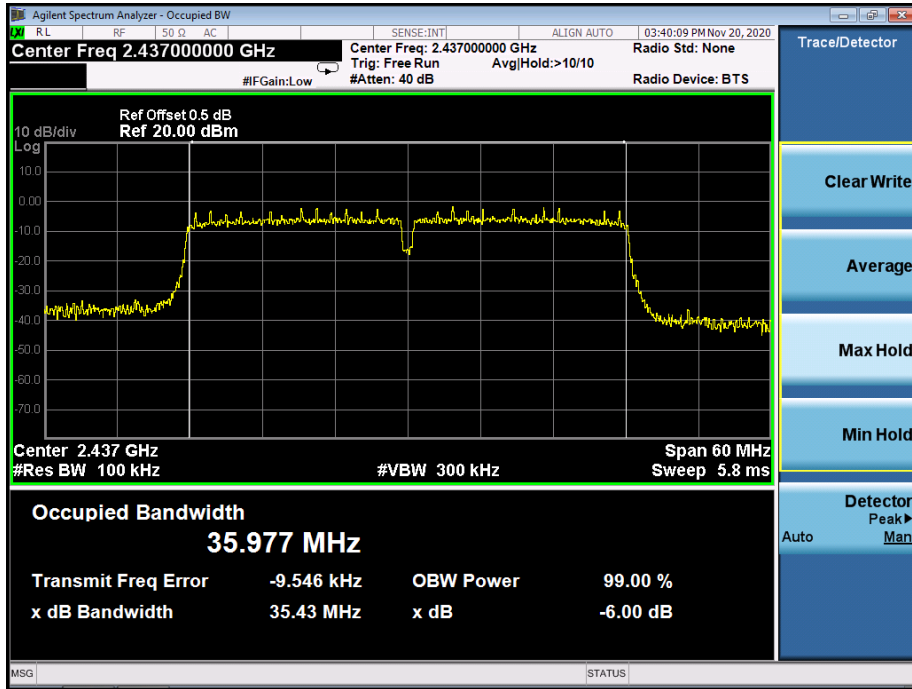

TX CH 09

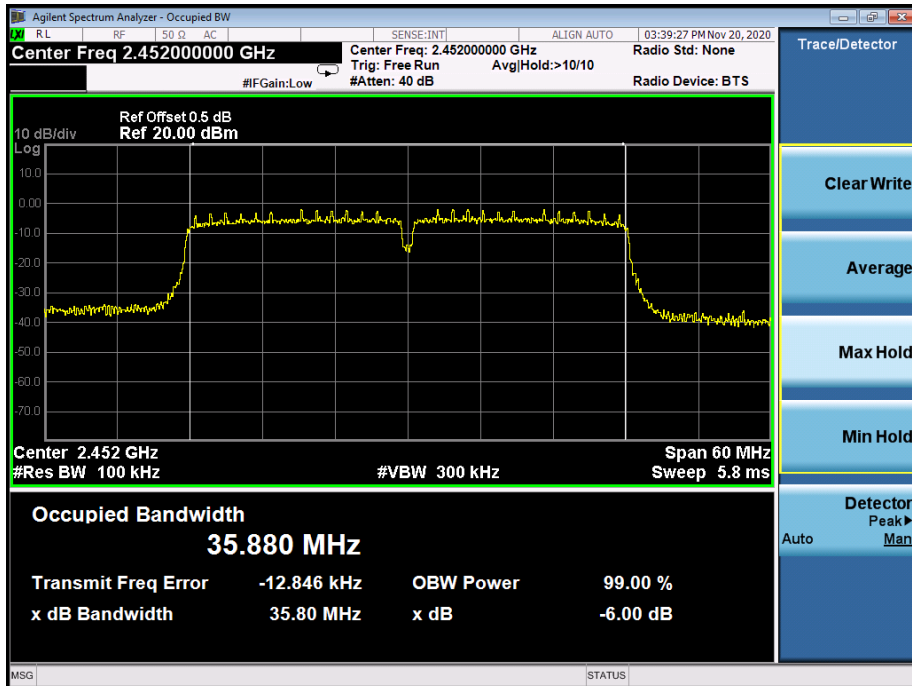

11. PEAK OUTPUT POWER TEST

11.1 Block Diagram Of Test Setup



11.2 Limit

FCC Part15 (15.247) , Subpart C				
Section	Test Item	Limit	Frequency Range (MHz)	Result
15.247(b)(3)	Peak Output Power	1 watt or 30dBm	2400-2483.5	PASS

11.3 Test procedure

- a. The EUT was directly connected to the Power meter

11.4 EUT operating Conditions

The EUT tested system was configured as the statements of 4.6 Unless otherwise a special operating condition is specified in the follows during the testing.

Note: Power Spectral Density(dBm)=Reading+Cable Loss

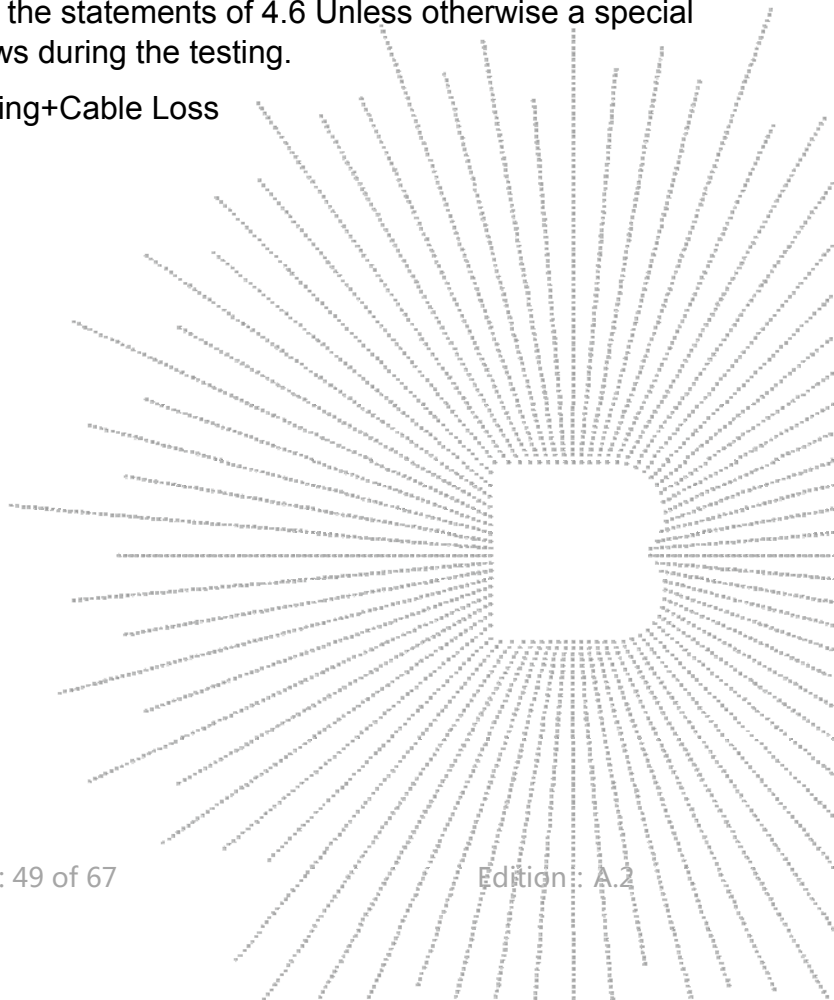

11.5 Test Result

Temperature :	26°C	Relative Humidity :	54%
Pressure :	101kPa	Test Voltage :	AC120V/60Hz

	Frequency	Maximum Conducted Output Power(PK)	LIMIT
	(MHz)	(dBm)	dBm
802.11b	2412	15.46	30
	2437	15.97	30
	2462	16.06	30
802.11g	2412	16.60	30
	2437	16.33	30
	2462	17.35	30
802.11n20	2412	15.77	30
	2437	15.73	30
	2462	16.06	30
802.11n40	2422	12.31	30
	2437	13.35	30
	2452	13.12	30

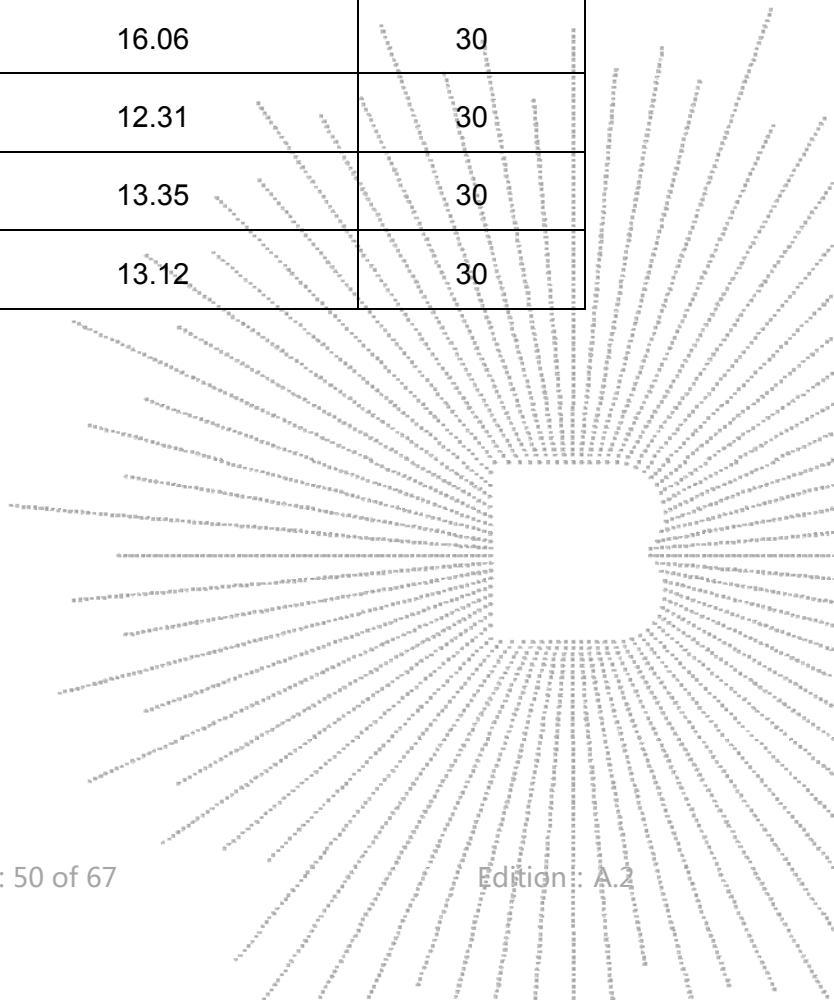

12. 100 KHZ BANDWIDTH OF FREQUENCY BAND EDGE

12.1 Block Diagram Of Test Setup

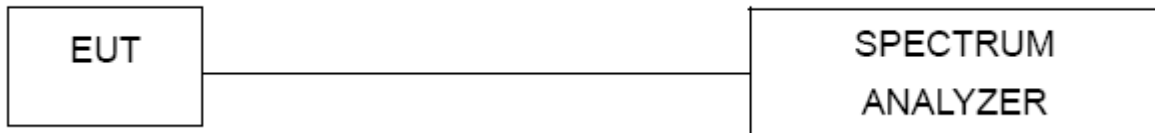

12.2 Limit

In any 100 kHz bandwidth outside the frequency band in which the spread spectrum intentional radiator is operating, the radio frequency power that is produced by the intentional radiator shall be at least 20 dB below that in the 100 kHz bandwidth within the band that contains the highest level of the desired power, based on either an RF conducted or a radiated measurement.

12.3 Test procedure

Using the following spectrum analyzer setting:

- a) Set the RBW = 100KHz.
- b) Set the VBW = 300KHz.
- c) Sweep time = auto couple.
- d) Detector function = peak.
- e) Trace mode = max hold.
- f) Allow trace to fully stabilize..

12.4 EUT operating Conditions

The EUT tested system was configured as the statements of 4.6 Unless otherwise a special operating condition is specified in the follows during the testing.

Note: Power Spectral Density(dBm)=Reading+Cable Loss

12.5 Test Result

Temperature :	26°C	Relative Humidity :	54%
Pressure :	101kPa	Test Voltage :	AC120V/60Hz

802.11b: Band Edge, Left Side



802.11b: Band Edge, Right Side



802.11g: Band Edge, Left Side

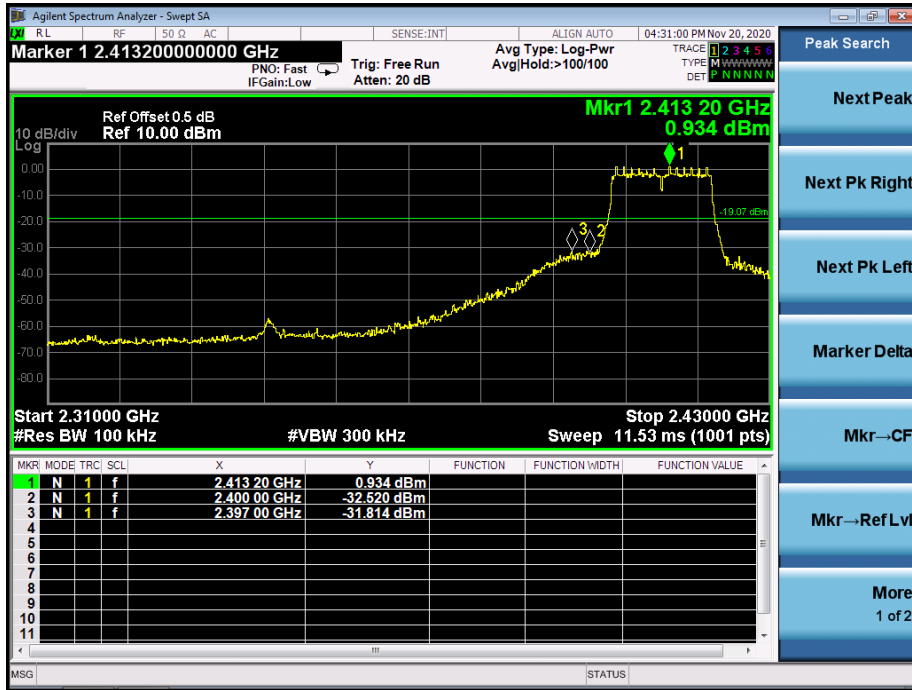

802.11g: Band Edge, Right Side



802.11n-HT20: Band Edge, Left Side

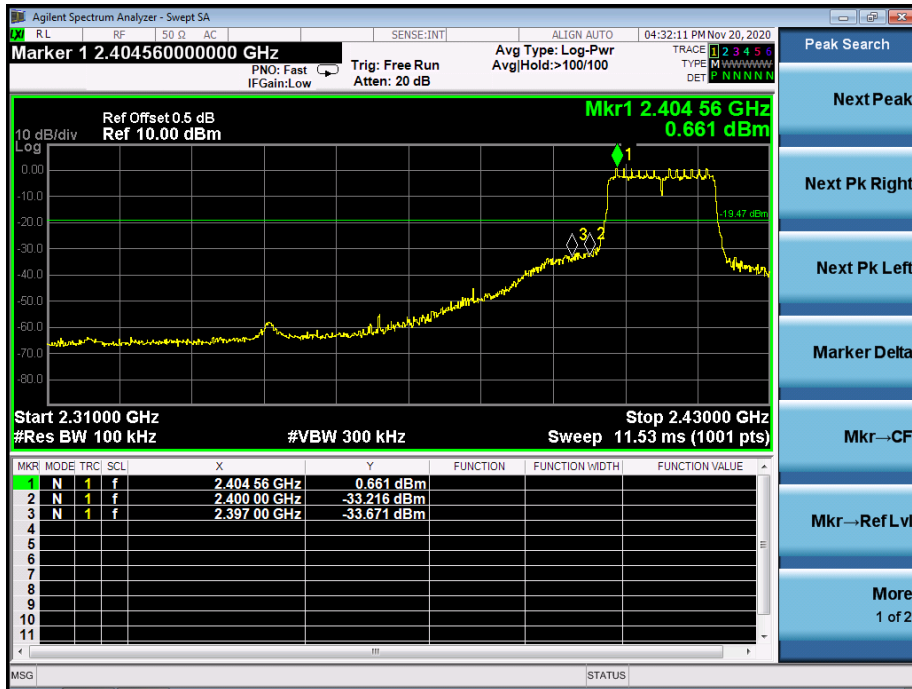

802.11n-HT20: Band Edge, Right Side

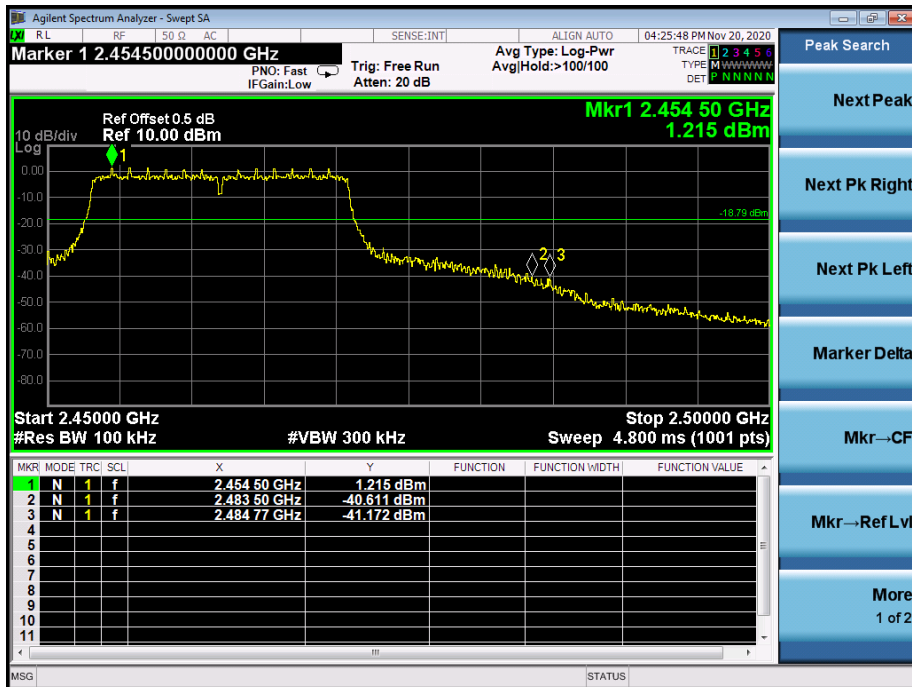

802.11n-HT40: Band Edge, Left Side

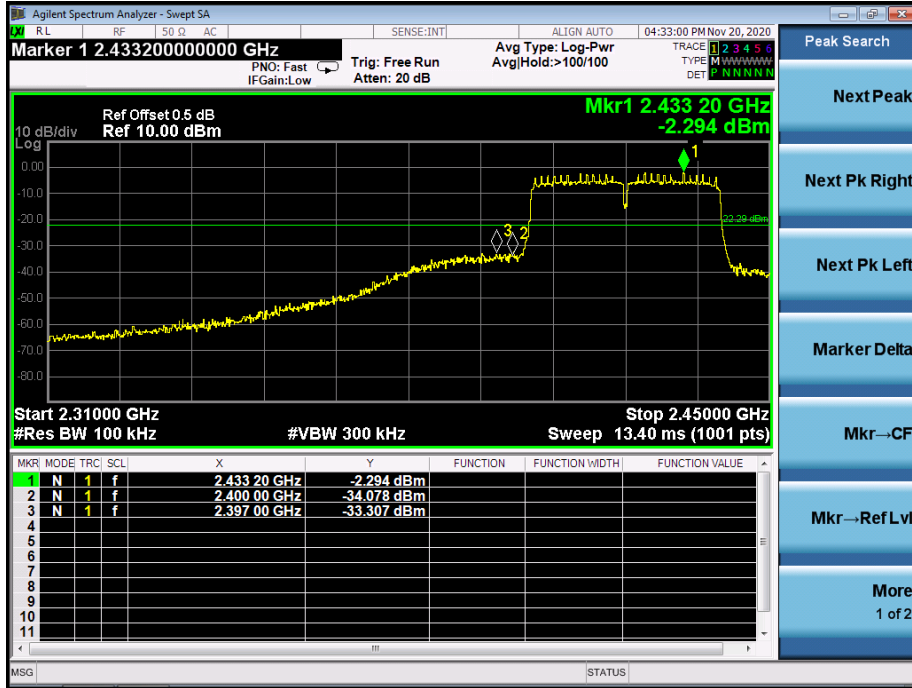

802.11n-HT40: Band Edge, Right Side

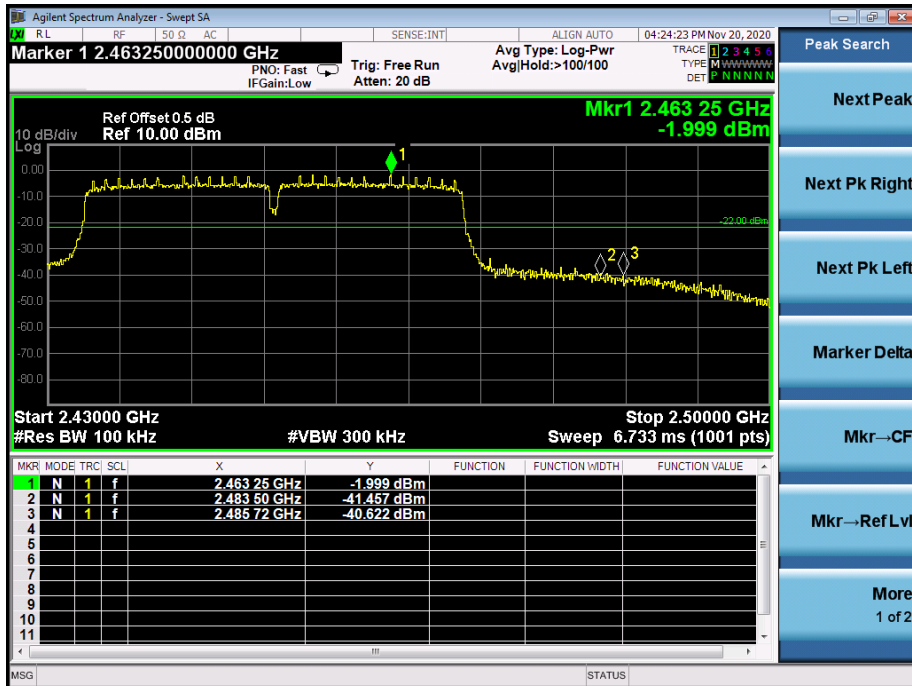

CONDUCTED EMISSION MEASUREMENT

802.11b

Low Channel 2412MHz

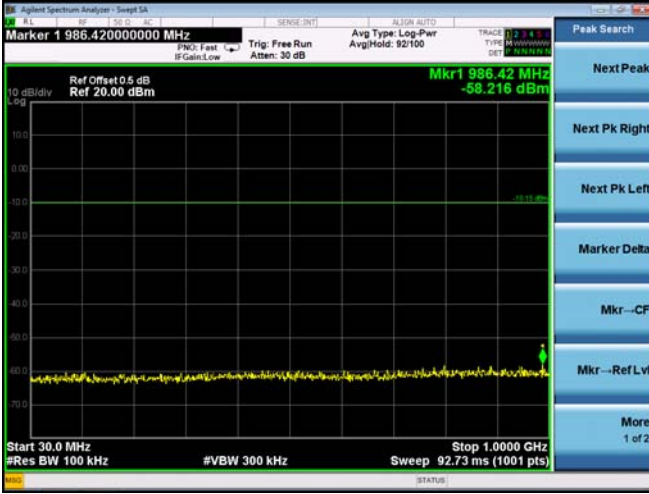

Middle Channel 2437MHz

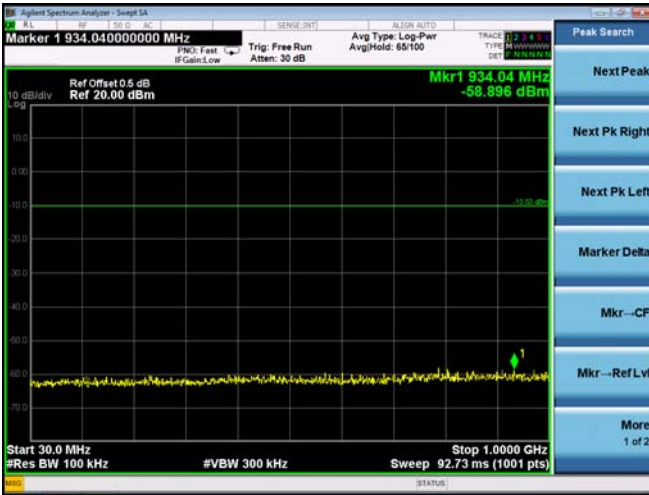

High Channel 2462MHz

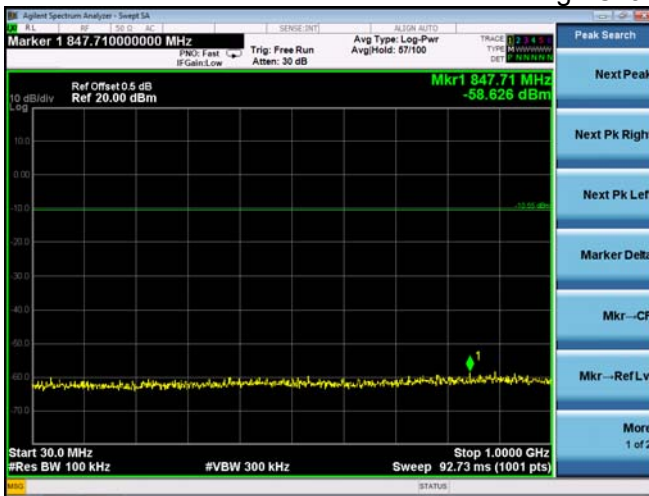

802.11g

Low Channel 2412MHz

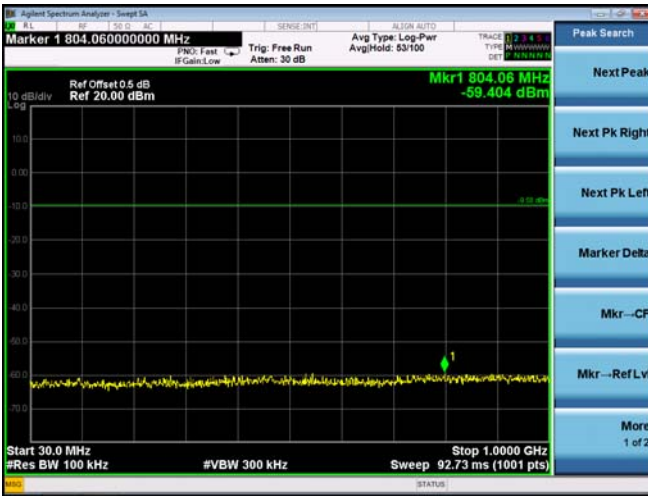

Middle Channel 2437MHz

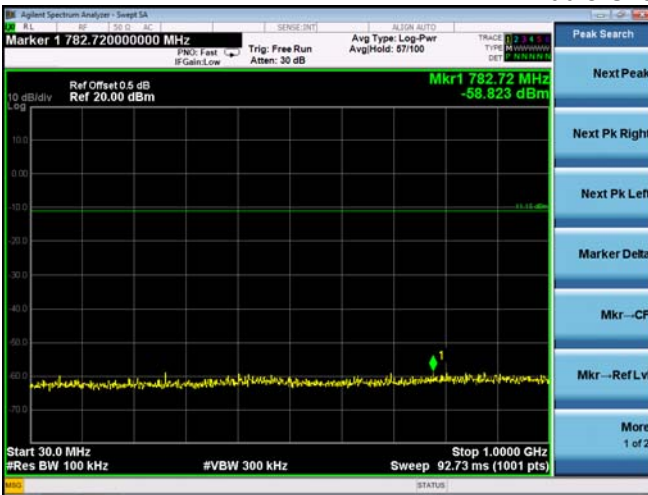

High Channel 2462MHz

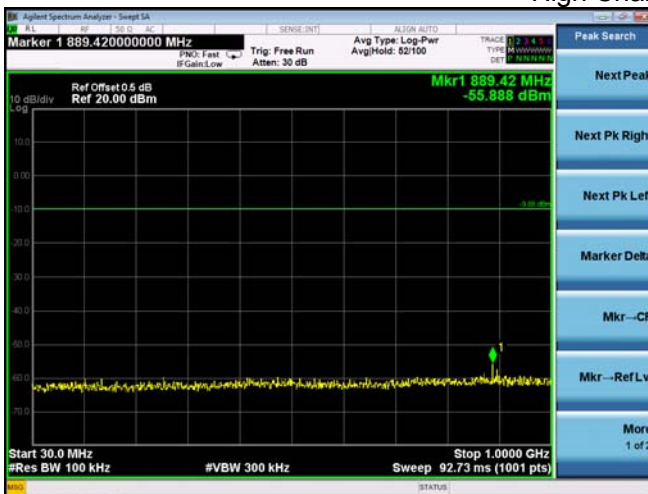

802.11n20

Low Channel 2412MHz

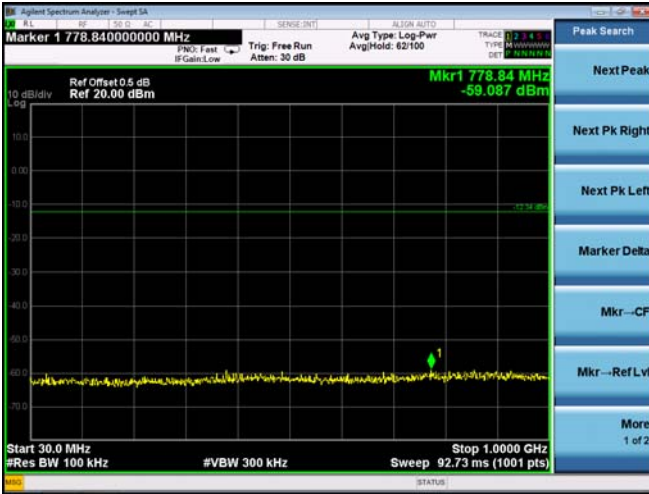

Middle Channel 2437MHz

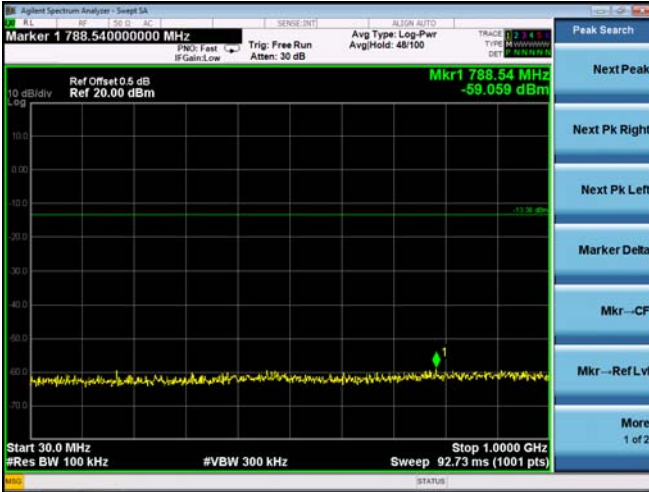

High Channel 2462MHz

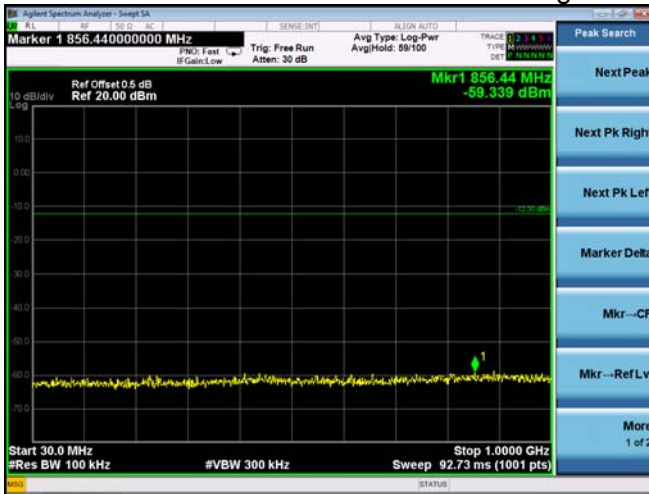

802.11n40

Low Channel 2422MHz

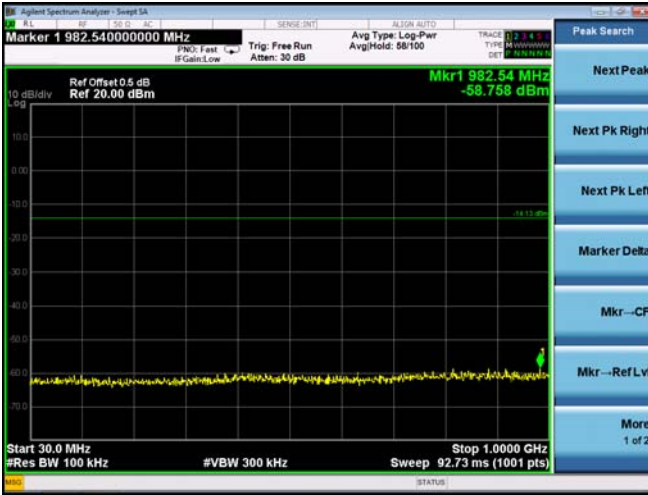

Middle Channel 2437MHz

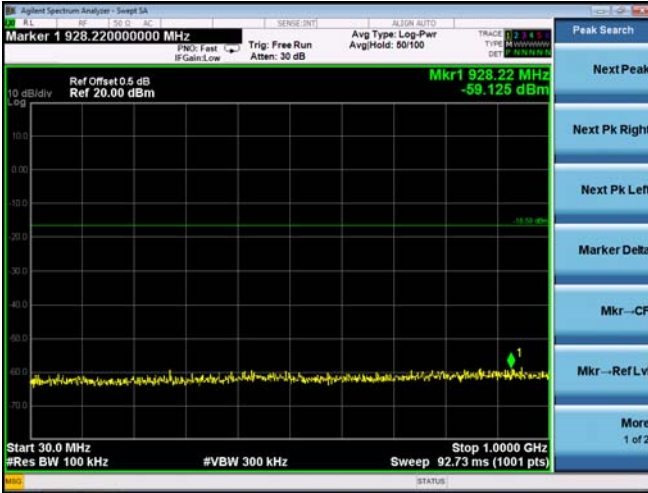

High Channel 2452MHz

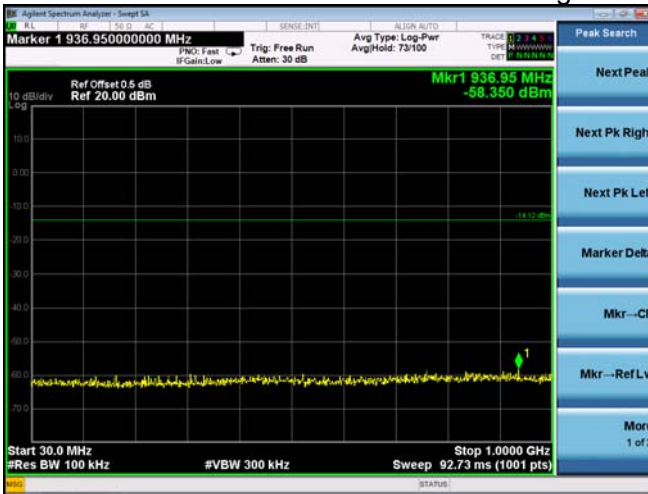

13. DUTY CYCLE OF TEST SIGNAL

13.1 Standard requirement

Pre-analysis Check: While conducting average power measurement, duty cycle of each mode shall be checked to ensure its duty cycle in order to compensate for the loss due to insufficient ratio of duty cycle.

All duty cycle is pre-scanned, and result as obtained below shows only the most representative ones where duty cycle is conducted as the given transmission with given virtual operation that expresses the percentage.

13.2 Formula

Duty Cycle = $T_{on} / (T_{on} + T_{off})$

13.3 Test procedure

1. Set span = Zero
2. RBW = 8MHz
3. VBW = 8MHz,
4. Detector = Peak

13.4 Test Result

	Duty Cycle	Duty Fator (dB)
802.11b	1	0
802.11g	1	0
802.11n(HT20)	1	0
802.11n(HT40)	1	0

802.11b

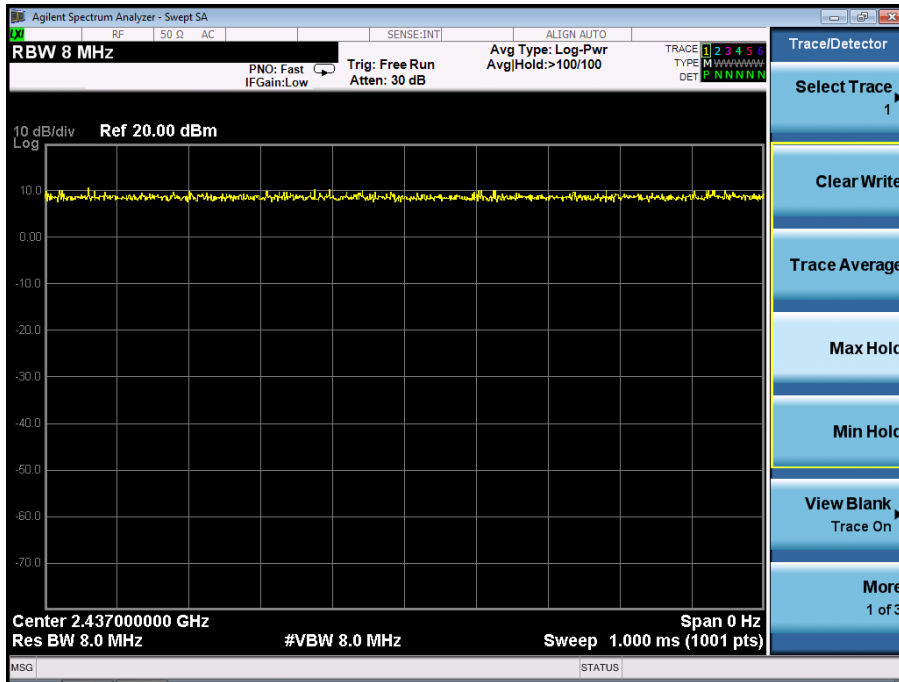

802.11g

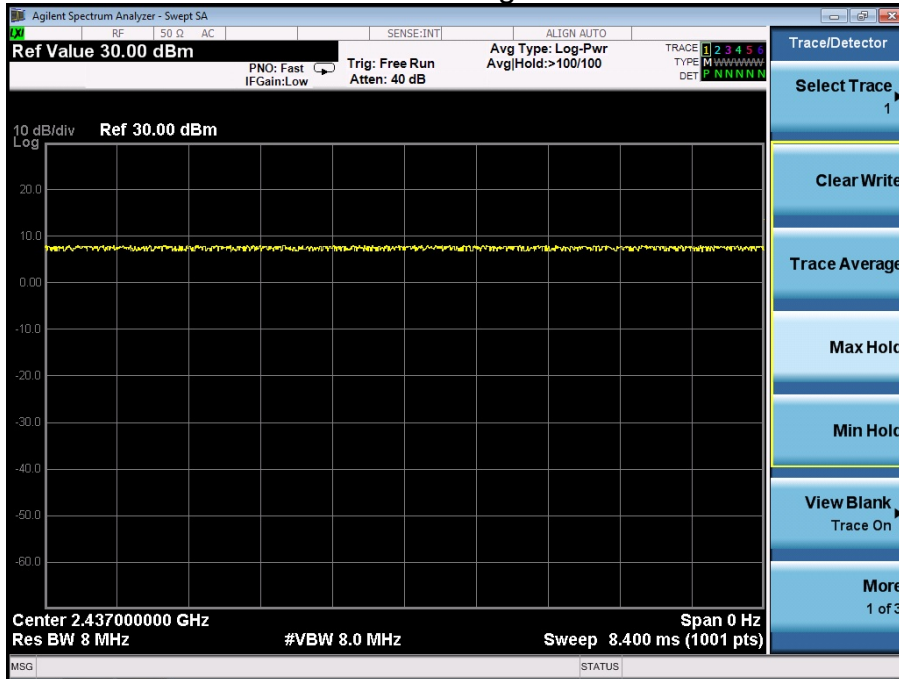

802.11n(HT20)

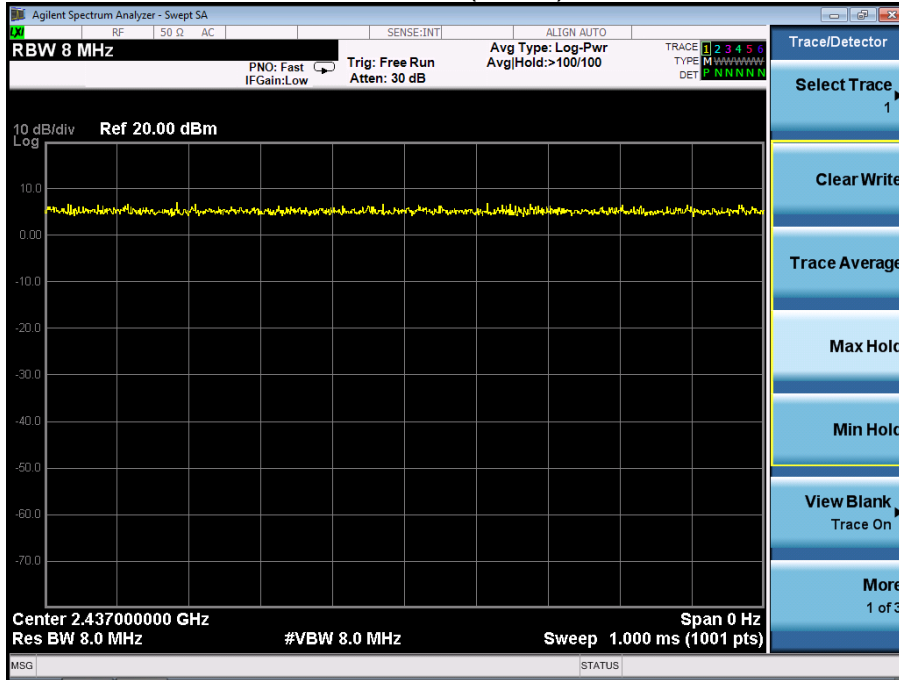

802.11n(HT40)

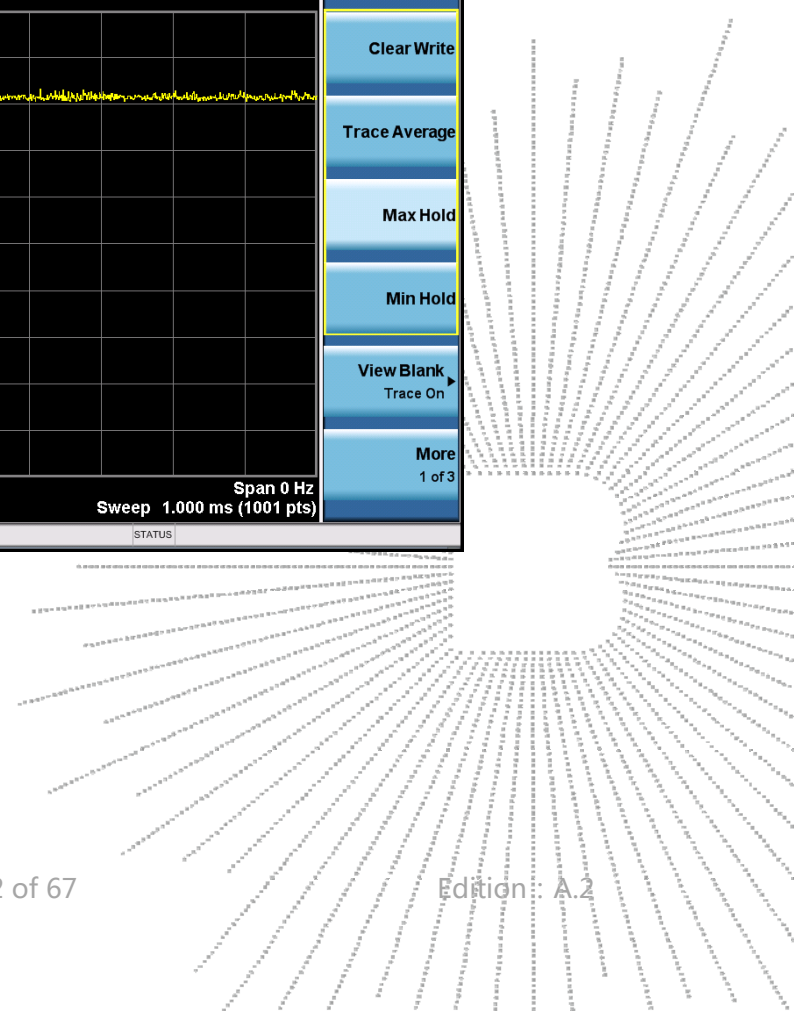
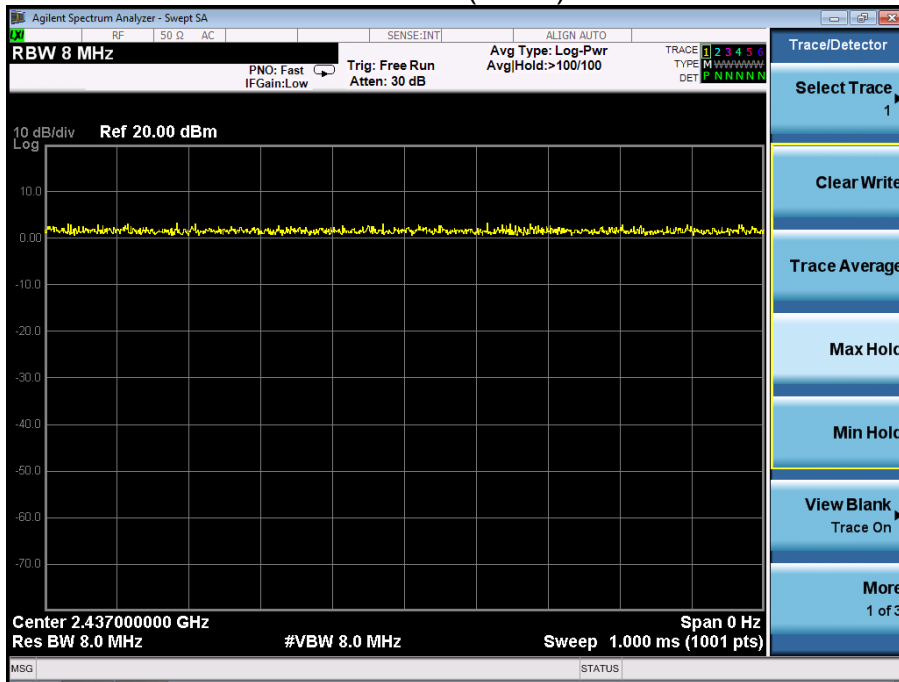

14. ANTENNA REQUIREMENT

14.1 Limit

15.203 requirement: For intentional device, according to 15.203: an intentional radiator shall be designed to ensure that no antenna other than that furnished by the responsible party shall be used with the device.

14.2 Test Result

The EUT antenna is Internal antenna, fulfill the requirement of this section.

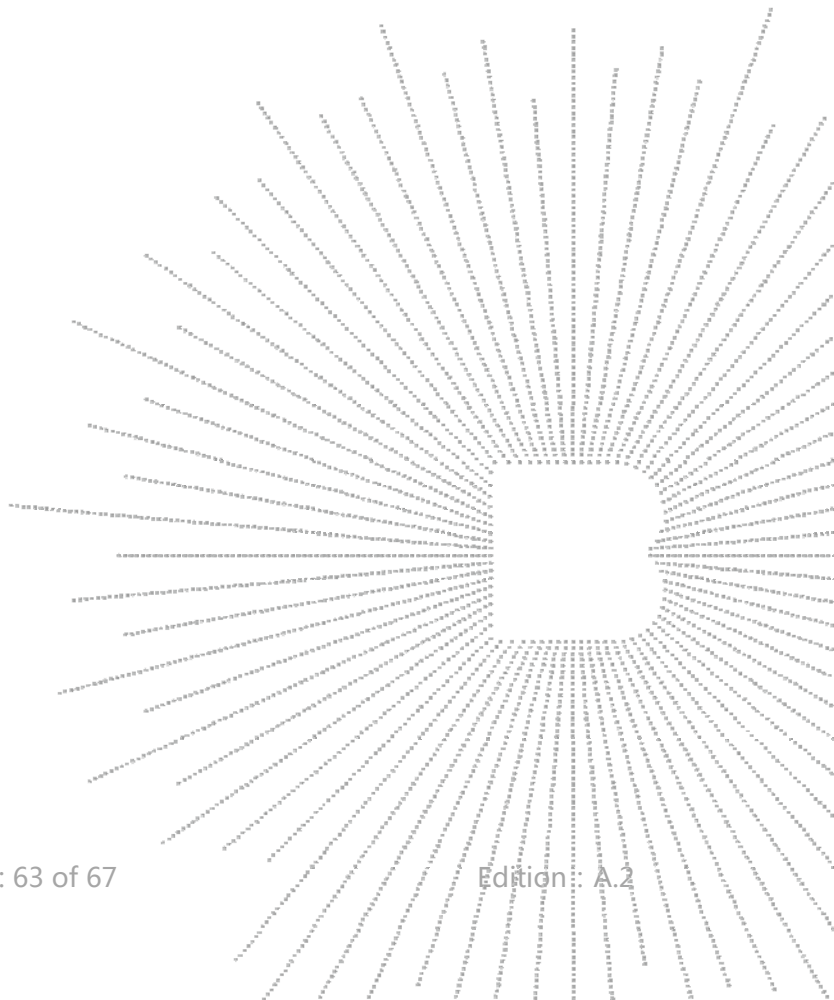

15. EUT PHOTOGRAPHS

EUT Photo 1



EUT Photo 2



16. EUT TEST SETUP PHOTOGRAPHS

Conducted emissions



Radiated Measurement Photos



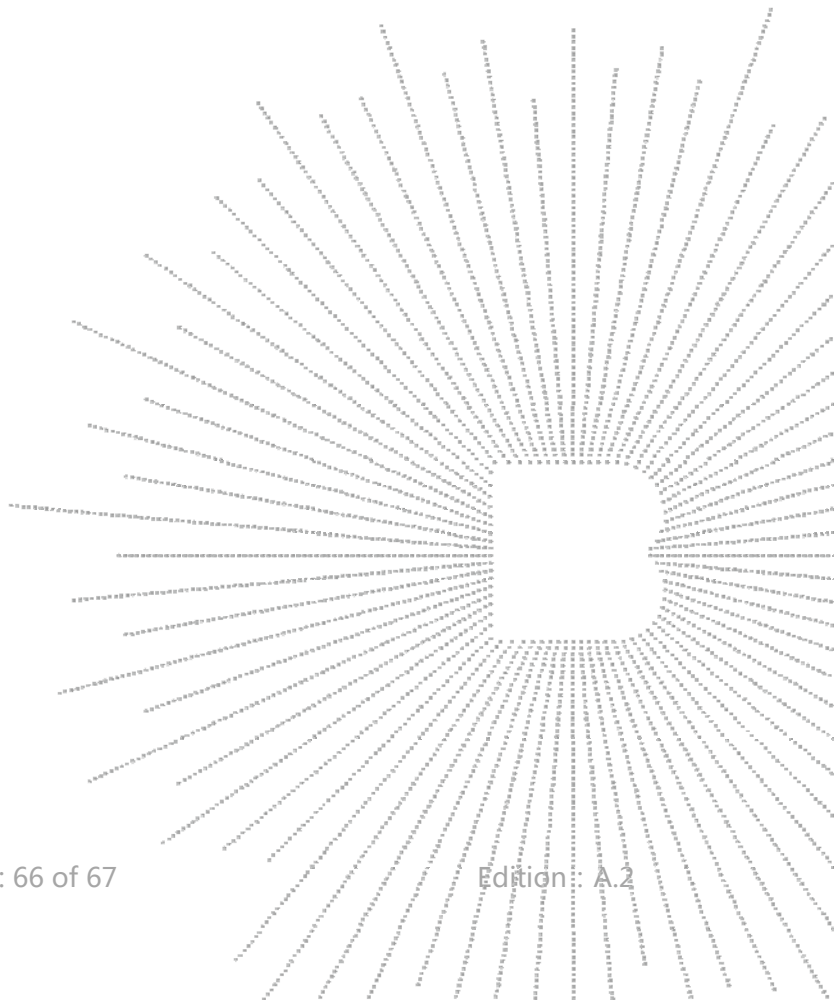

STATEMENT

- 1.The equipment lists are traceable to the national reference standards.
- 2.The test report can not be partially copied unless prior written approval is issued from our lab.
- 3.The test report is invalid without stamp of laboratory.
- 4.The test report is invalid without signature of person(s) testing and authorizing.
- 5.The test process and test result is only related to the Unit Under Test.
- 6.The quality system of our laboratory is in accordance with ISO/IEC17025.
- 7.If there is any objection to report, the client should inform issuing laboratory within 15 days from the date of receiving test report.

Address:

1-2F, East of B Building, Pengzhou Industrial Park, Fuyuan 1st Road, Qiaotou, Fuyong Street,
Bao'an District, Shenzhen, Guangdong, China

TEL : 400-788-9558

P.C.: 518103

FAX : 0755-33229357

Website : <http://www.bctc-lab.com>

E-Mail : bctc@bctc-lab.com.cn

***** END *****