

DOG TRAINING COLLAR



Model: VS8

I. Important Safety Information:

WARNING

Not for use with aggressive dogs. Do not use this product if your dog is aggressive, or if your dog is prone to aggressive behavior. Aggressive dogs can cause severe injury and even death to their owner and others. If you are unsure whether this product is appropriate for your dog, please consult your veterinarian or a certified trainer.

- For use with dogs over 6 months of age and over 8 lbs.
- **DO NOT** use when the dog or the collar is wet.
- **DO NOT** press and hold the Warning Tone Button, Vibration Button and Vibration Boost Button too often for more than 10 seconds to avoid physical or psychological damage to your dog.
- Your dog **SHOULD NOT VOCALIZE OR PANIC** when receiving stimulation. If this happens, the stimulation level is too high and you need to go back to the previous level and repeat the process.
- **DO NOT** charge the device near any flammable substances.
- For dog use **ONLY**. Not for use on children.
- This is not a toy, and should only be operated by a responsible adult.

CAUTION

Before your first training, please read and follow the instructions in this manual carefully. The cautions below will help keep your dog safe and comfortable. Millions of dogs are comfortable when they wear stainless steel contacts, while some dogs are sensitive to contact pressure.

- **It is vitally important that you and your dog remain safe while learning during on-leash training.** Your dog should be on a strong leash (do not attach the leash to the Training Collar), long enough for him to attempt to chase an object, but short enough for him not to reach a road or other hazard. You must also be physically strong enough to restrain your dog when he tries to chase.
- **Risk of skin damage.** Proper collar fitment is important. A collar worn for too long or made too tight on the dog's neck may cause skin damage. Ranging from redness to pressure ulcers; this condition is commonly known as bed sores.
- **DO NOT leave the collar on the dog for more than 12 hours per day.**
- When possible **re-position the collar on the dog's neck every 1 to 2 hours.**
- **Check the fit to prevent excessive pressure;** follow the instructions in this manual.
- **Never connect an extra leash to the collar;** it will cause excessive pressure on the contacts.
- **Clean the dog's neck area and the contact probes of the collar weekly** with a damp cloth.
- **Examine the contact area daily** for signs of a rash or a sore.
- **If a rash or sore is found, discontinue the use of the collar** until the skin has healed. If the condition persists beyond 48 hours, see your veterinarian.
- **Receiver collar meets IP67 waterproof rating,** it can be submerged in water up to 1 meter for up to 30 minutes. If submerged and wet, please do not use it.

II. Quick Start Guide

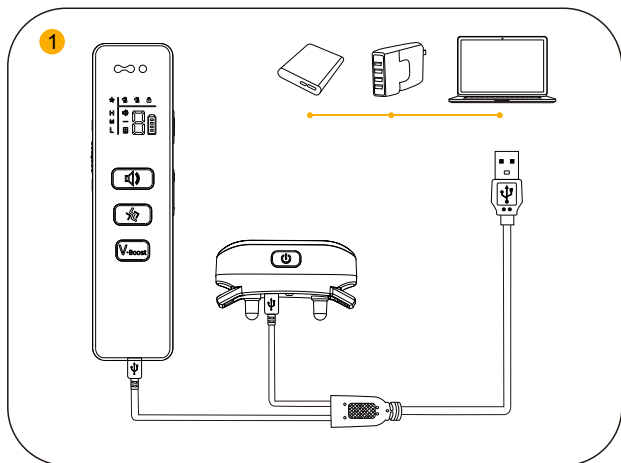

Charge the Receiver and the Remote Transmitter for 2-3 hours with the double-headed Micro-USB cable from the package box.

Note: The charger, power bank and other charging devices shown in the above picture are not included in the box.

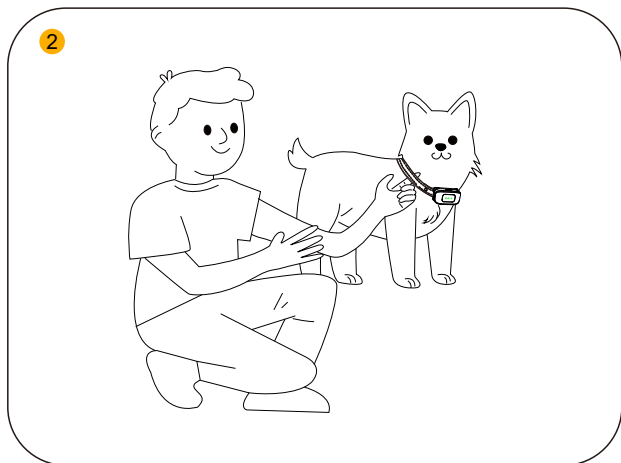

Let your dog stand on four feet or lay down fully. Fit the Receiver to your dog by leaving one finger space between the collar and your dog's neck. Center the contact points underneath your dog's neck, touching the skin.

3

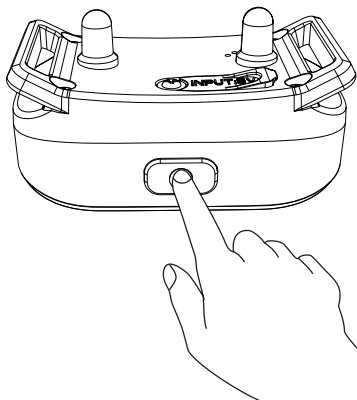

Turn on the Receiver by pressing and holding the Power Button for 2 seconds with a vibration to indicate that the Receiver turns on. The Battery Bar Indicator turns off after 15 seconds of being on, and then the green Indicator continues to blink regularly.

4

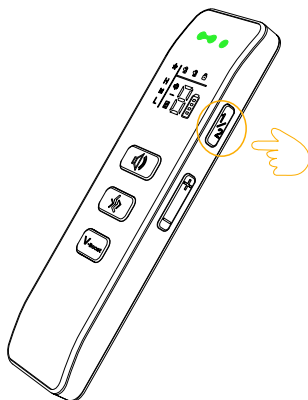

Turn on the Remote Transmitter by pressing and holding the On/Off (Channel) Button for 2 seconds.

5

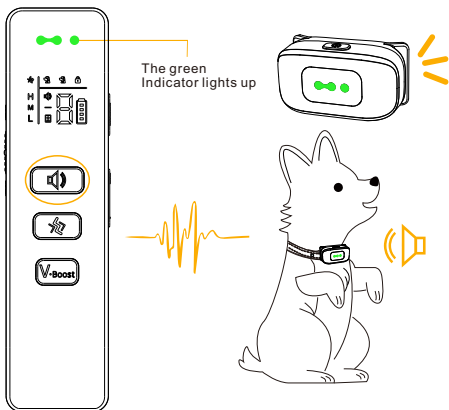

Warning Tone Command: Press the Warning Tone Button, and the Receiver will deliver a warning tone (both the green Indicator on the Remote Transmitter and the Receiver light up simultaneously). The Beep level is 1-8 adjustable. Adjust the Warning Tone Level by pressing the Level Up/Down Button.

6

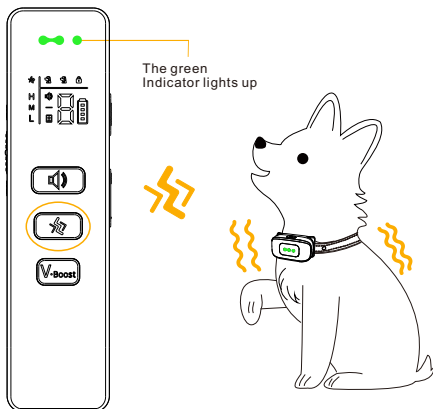

Vibration Command: Press the Vibration Button, and the Receiver will deliver vibration (both the green Indicator on the Remote Transmitter and the Receiver light up simultaneously). The Vibration level is 1-3 adjustable: L (Light), M (Medium), and H (High). Adjust the Vibration Level by pressing the Level Up/Down Button.

7



The red Indicator lights up

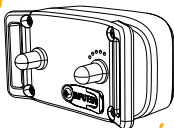

V-Boost



Vibration Boost Command: Press the Vibration Boost Button, and the Receiver will deliver a boosted vibration (the red Indicator on the Remote Transmitter and the green Indicator on the Receiver light up simultaneously). The intensity of the Vibration Boost remains constant.

8



Dog 1



Dog 2

Switch the channel by pressing the On/Off (Channel) Button. This Remote Training Collar can train up to 2 dogs.

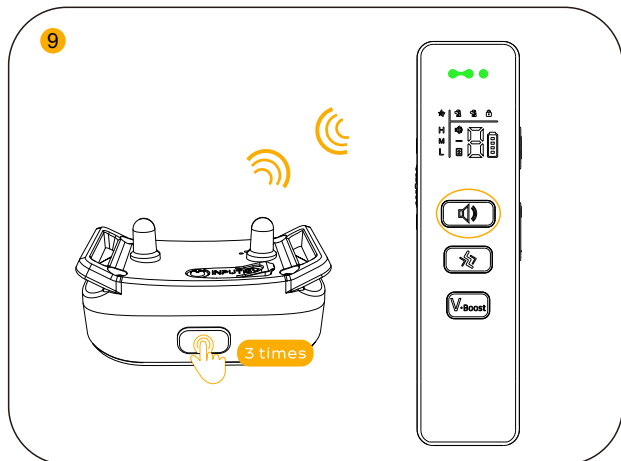

Steps to pair the Remote Transmitter to the Receiver:

1. Press and hold the Power Button on the Receiver for 2 seconds to turn it on. Turn on the Remote Transmitter by pressing and holding the On/Off (Channel) Button for 2 seconds;
2. Press the Power Button on the Receiver 3 times to enter the Pairing Mode. You will hear a beeping tone and the Indicator becomes solid green. You will now have 10 seconds to finish the pairing;
3. Press the Beep Button, Vibration Button, or Vibration Boost Button on the Remote Transmitter, and Receiver will respond correspondingly indicating that the pairing process is completed. Please refer to "VI. Pairing Up" on page 15 for more details.

III. Package Content



Remote Transmitter

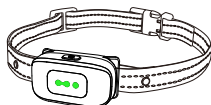

Receiver



User Manual

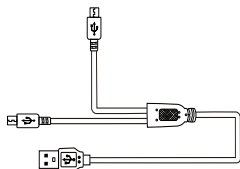

Charging Cable

IV. Product Overview

Remote Transmitter

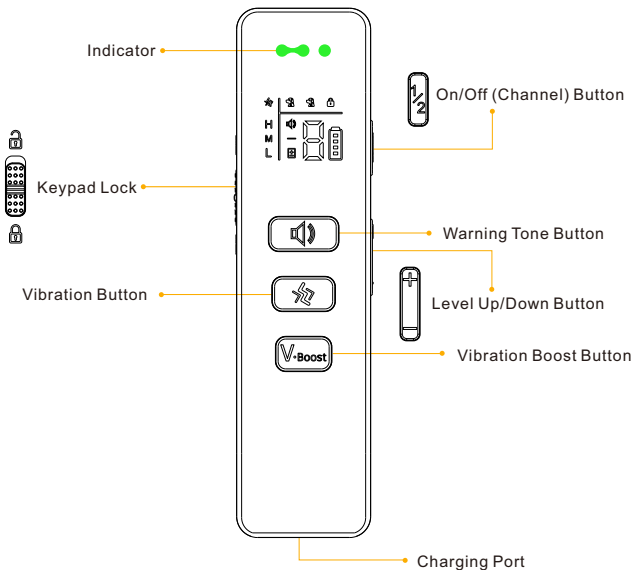

(1) The icons “red lock” and “battery bar” will be displayed when the Remote Transmitter is set to the locked state.

(2) The Remote Transmitter will go into sleep mode if there is no operation in 30 seconds.

Display Screen

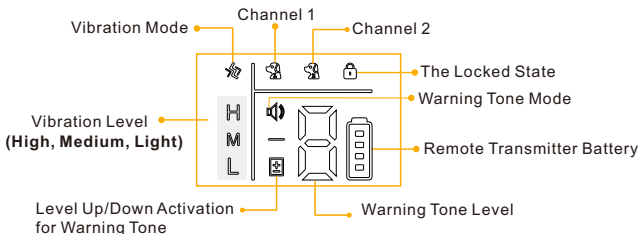

Receiver

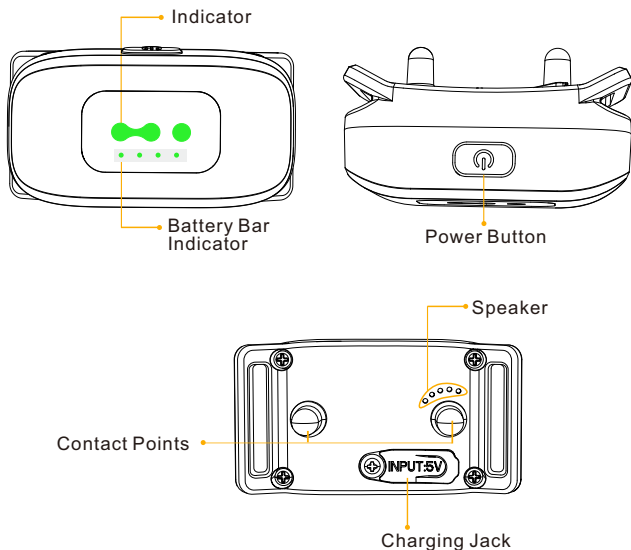

How the System Works

The Remote Training Collar is easy to use with an advanced digital display that tells you the exact stimulation level you are using.

The Remote Training Collar assists you in controlling your dog without a leash. At the push of a button, your Remote Transmitter sends a signal activating your dog's Receiver. He receives a safe but annoying stimulation. He'll quickly learn the association between his behavior and your correction, and soon you'll have a better-behaved dog.

The Remote Training Collar has been proven safe, comfortable, and effective for both small and large dog breeds.

If using the Remote Training Collar consistently and correctly, any basic obedience commands can be taught and will help correct any misbehavior that your dog exhibits.

V. Setting Up

1. Charge the Product

Charge both the Receiver and the Remote Transmitter with the charging cable in the package box until their Indicator becomes solid green which will take around 2-3 hours.

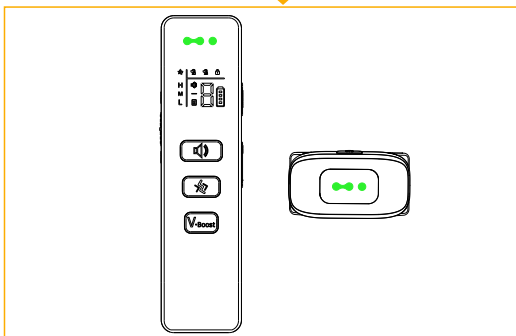
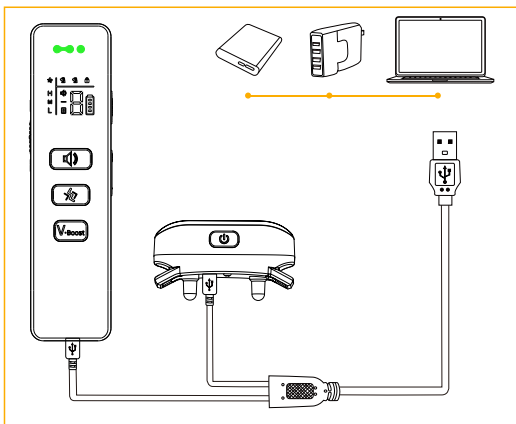

Note:

- (1) The charger, power bank and other charging devices shown in the above picture are not included in the box.
- (2) Use the charging cable in the package when charging. Other charging cables may not be suitable for this Bark Collar, which may cause electric damage.
- (3) The Remote Training Collar **ONLY** supports a **5V-rated power source**. If charged with an improper charger:

Receiver—deliver a rapid warning tone and stop charging automatically

Remote Transmitter—stop charging automatically with the Indicator rapidly blinking in red

2. Turn On/Off the Product

Turn on/off the Remote Transmitter by pressing and holding the On/Off (Channel) Button for 2/3 seconds.

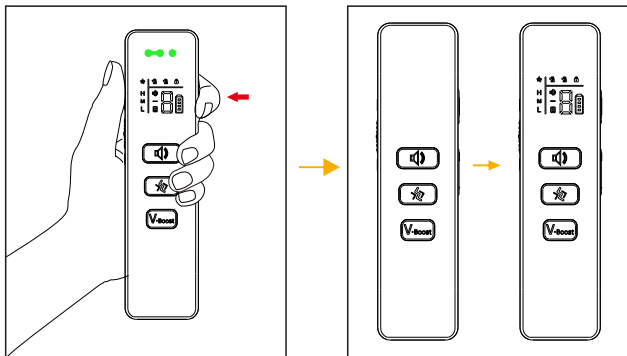

Turn on the Receiver by pressing and holding the Power Button for 2 seconds with vibration, as the green LED Indicator light blinks regularly after the Battery Bar Indicator is on for 15 seconds.

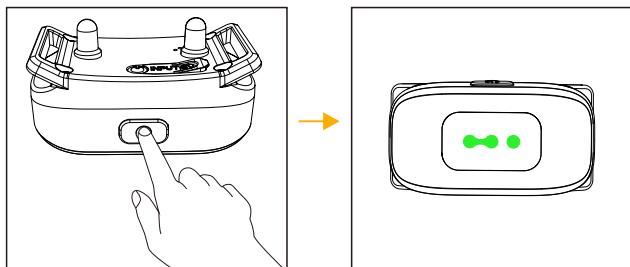

Turn off the Receiver by pressing and holding the Power Button for 3 seconds with a long beeping, as the green LED Indicator light stops blinking.

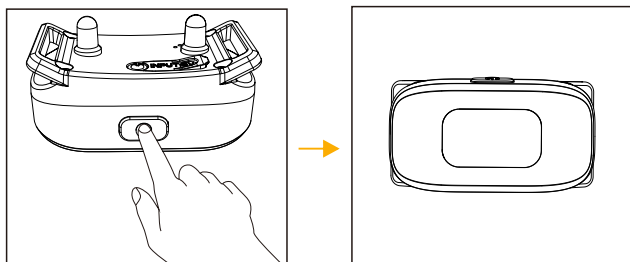

VI. Training Modes

1.Warning Tone Mode

Press the Warning Tone Button and the Receiver will deliver a warning tone. It will cut off automatically if you press and hold the Warning Tone Button for 10 seconds. There is a total of 8 levels of Warning Tone for training which you can adjust by selecting the Warning Tone Button and pressing the Level Up/Down Button.

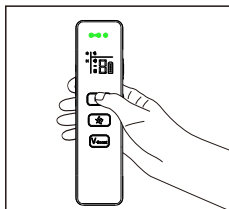

Press

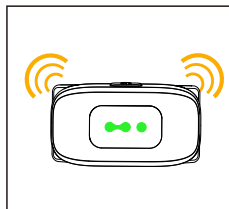

2.Vibration Mode

Press the Vibration Button and the Receiver will deliver a vibration. It will cut off automatically if you press and hold the Vibration Button for 10 seconds. There is a total of 3 levels of Vibration for training (**L for Light, M for Medium, and H for High**) which you can adjust by selecting the Vibration Button pressing the Level Up/Down Button.

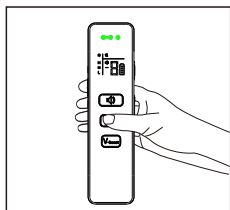

Press

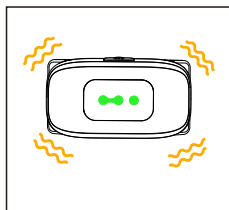

3.Vibration Boost Mode

Press the Vibration Boost Button and the Receiver will deliver a boosted vibration. It will cut off automatically if you press and hold the Vibration Boost Button for 10 seconds.

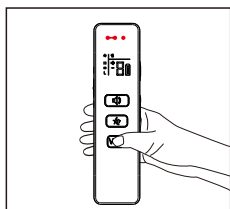

Press

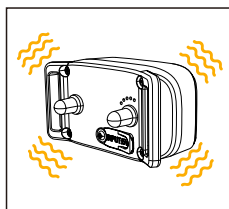

4. Switching Channels

Press the On/Off (Channel) Button to choose the Receiver you want to control if you have paired up two Receivers.

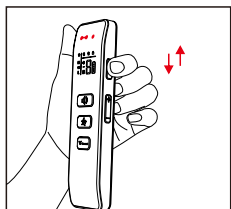

Press

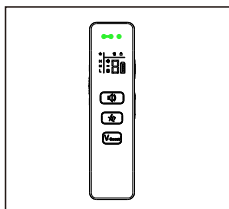

5. Sleep Mode

The Remote Transmitter will enter sleep mode to save battery power if there is no operation for 30 seconds.

VII. Fitting the Receiver

IMPORTANT:

The proper fit and placement of your Receiver are important for effective training. To assure a proper fit, please follow these steps:

1. Make sure that the Receiver is turned off.
2. Let your dog stand on four feet or lay down fully (A).
3. Place the Receiver on your dog's neck close to the ears. Center the Contact Points underneath your dog's neck, touching the skin (B).
Note: It is sometimes necessary to trim the hair around the Contact Points to make sure that contact is consistent.
4. The Receiver should fit snugly, yet loose enough to allow one finger to fit the strap and your dog's neck (C).
5. Allow your dog to wear the collar for several minutes then recheck the fit. Check the fit again as your dog becomes more comfortable with the Receiver.

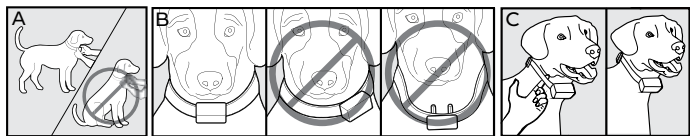

6. To attach the collar to the Receiver, please follow the following steps as instructed to thread the strap.

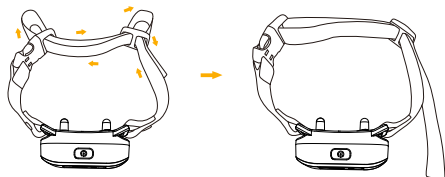

CAUTION :

It is sometimes necessary to **trim the hair around the Contact Points** to make sure that contact is consistent.

- **DO NOT** shave the dog's neck as this may increase the risk of skin irritation.
- **Check the fit regularly** to make your dog more comfortable with the collar.

VIII. Pairing Up

If you feel the Receiver is not responding to the Remote Transmitter, follow these steps to pair them up.

1. Press and hold the Power Button on the Receiver for 3 seconds to turn it on. Turn on the Remote Transmitter by pressing the On/Off (Channel) Button for 2 seconds.

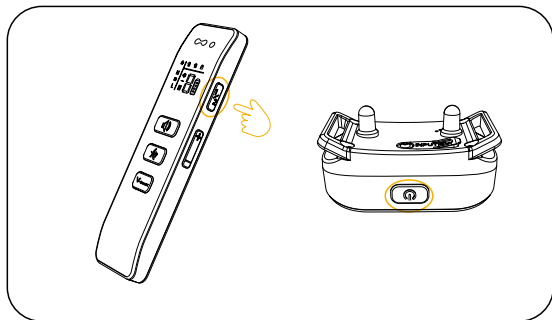

2. Press the Power Button on the Receiver 3 times to enter the Pairing Mode. You will hear a Beeping tone and the LED Indicator light becomes solid green. You will now have 10 seconds to finish the pairing.

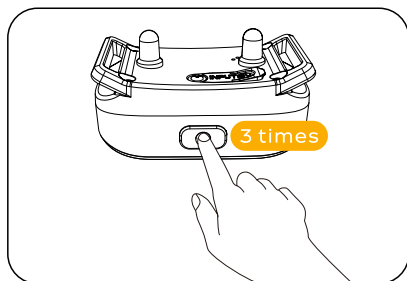

3. Press the Warning Tone Button, Vibration Button, or Vibration Boost Button on the Remote Transmitter, and the Receiver will respond correspondingly indicating that the pairing process is completed.

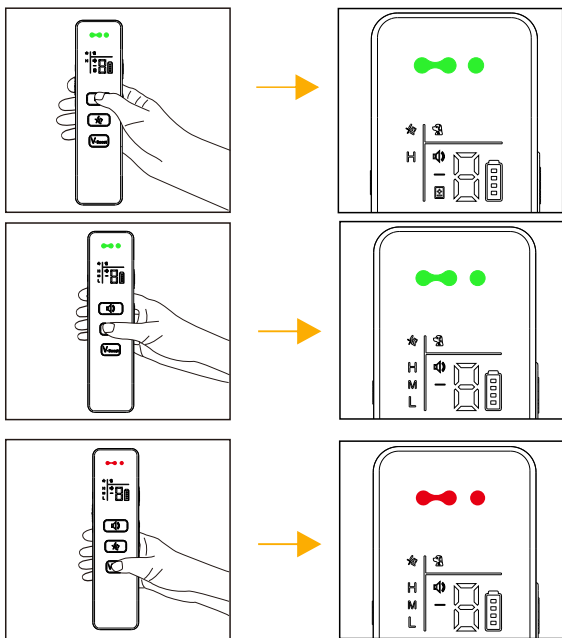



Tips:



The Receiver is paired to the Remote Transmitter by the factory default setting. If you find the Receiver does not respond to the Remote Transmitter when you get the product or during use, please follow the above steps to pair the Receiver to the Remote Transmitter again.

IX. Indicator Definitions

Remote Transmitter Indicator:

Charging	The Green Indicator light blinks slowly
Fully Charged	The Green Indicator light becomes solid
Press 	A Green Indicator light comes up
Press 	A Green Indicator light comes up
Press 	A Red Indicator light comes up

Receiver Indicator :

	Fast blinking indicates the Receiver is on charge
	Blinking at high speed indicates the Receiver battery is low
	Solid green Battery Bar indicates the Receiver is fully charged
	Slowly blinking indicates the Receiver is on
	A Green Indicator light comes up when any of the three functions is activated

X. Training Tip

Find the best stimulation for your dog

Important: Always start at the lowest level and work your way up.

The Remote Training Collar has 8 types of Warning Tones, 3 levels of Vibration (Light, Medium, and High), and the Vibration Boost with a constant intensity. For Warning Tones, there are 8 types of Tones, with only frequency differences between the different types. For Vibration, level L is the lowest; level H is the highest.

This allows you to choose the Stimulation level that is best for your dog. Once you have placed the Receiver on your dog, it is time to find the Stimulation Level that is best for him. This is called the Recognition Level.

A slight change in your dog's behavior, such as looking around in curiosity, scratching at his collar, or flicking his ears, indicates the Recognition Level that is best for your dog.

Follow the steps below to find your dog's Recognition Level:

1. Starting at the lowest level, press the Warning Tone/Vibration/Vibration Boost Button continuously for 1 to 2 seconds.

Note: When the Warning Tone/Vibration/Vibration Boost Button is held down for 10 consecutive seconds, the Remote Transmitter will "time out", and you must release and press the button again before additional stimulation can be delivered.

2. If your dog shows no reaction, repeat the Stimulation Level several times before moving up to the next level.

3. YOUR DOG SHOULD NOT VOCALIZE OR PANIC WHEN RECEIVING STIMULATION. IF THIS HAPPENS, THE STIMULATION LEVEL IS TOO HIGH AND YOU NEED TO GO BACK TO THE PREVIOUS LEVEL AND REPEAT THE PROCESS.

4. Move up through the Stimulation Level until your dog reliably responds to the stimulation.

5. If your dog continues to show no response at the highest level of the Warning Tone and Vibration, or Vibration Boost, check the fit of the Receiver. Then go back to #1 and repeat the process. If this still does not yield any results, your dog's hair will need to be trimmed around the Contact Points.

If, after completing all of these steps, your dog still does not indicate he is feeling the stimulation, please contact our customer service.

How to Maximize the distance?

Terrain, weather, vegetation, transmission from other radio devices, and other factors will affect the maximum range.

Hold the Remote Transmitter in a horizontal position away from your body to achieve optimum range. For maximum signal strength, keep the device properly charged.

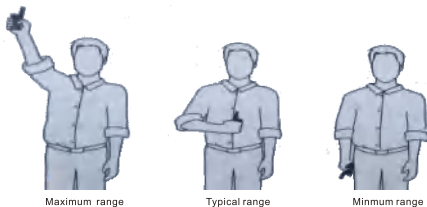

Maximum range

Typical range

Minnum range

*Avoid touching the antenna or the range may decrease substantially.

XI. Frequently Asked Questions

Q: Is the Receiver waterproof?

A: Yes. The Receiver meets the IP67 waterproof rating, but make sure to keep the area dry when charging.

Note: Remote Transmitter is not waterproof.

Q: Is the Stimulation safe for my dog?

A: While the Stimulation is unpleasant, it is harmless to your dog. Electronic training devices require interaction and training from the owner to achieve desired results.

Q: How long can I continuously deliver stimulation to my dog?

A: The maximum amount of time you can press the Warning Tone/Vibration/Vibration Boost Button and deliver stimulation to your dog continuously is 10 seconds. After this, the Remote Transmitter will time out, and these stimulation buttons must be released and pressed again.

Q: What should I do if my dog's neck becomes red and irritated?

A: Stop using the product immediately for at least 48 hours. If the condition persists beyond 48 hours, please consult your veterinarian.

Q: Can I attach a leash to the Receiver?

A: No. This may cause the Contact Points to be pulled too tightly against the dog's neck. If needed, please use a separate collar.

Q: When should I recharge the Remote Transmitter and Receiver?

A: The low battery bar symbol on the Remote Transmitter Screen flashes at high speed, indicating the need for charging; The Battery Bar Indicator on the Receiver flashes at high speed, indicating the need for charging.

Q: How old does my dog have to be before using the Remote Training Collar?

A: Your dog should be able to recognize basic obedience commands such as Sit" or "Stay". Dogs should be at least 6 months old before using the Remote Training Collar.

Q: Once my dog is trained and has been obeying my commands, will he have to continue to wear the Receiver?

A: Probably not. You may need to reinforce training with the Receiver from time to time.

Q: Will I get a maximum range with the Remote Training Collar?

A: The range of the Remote Training Collar will vary according to terrain, weather, vegetation, as well as transmission from other radio devices. See "How to Maximize the Distance" on page 18 for tips on maximizing your range.

XII. Trouble Shooting

1. My dog does not respond when I press a button.

- ◆ Make sure the Receiver has been turned on.
- ◆ If your range has reduced from the first time you used the Remote Training Collar, the battery(-ies) may be low in either the Remote Transmitter or Receiver.
- ◆ Many factors can impact the amount of range you have with the Remote Training Collar. For a list of these factors, see "How to Maximize the Distance" on page 18.
- ◆ Increase the Stimulation Level. Refer to "Find the best stimulation for your dog" on page 17 for more information.
- ◆ Make sure the Receiver's Prongs are placed snugly against your dog's skin. Refer to "Fitting the Receiver" on page 13 for more information.

NOTE: If the Indicator does not flash, recharge the Receiver and re-test. If the Indicator still does not flash, please contact our customer service. Increase the Stimulation Level. Refer to "Find the best stimulation for your dog" on page 17 for more information.

Make sure the Receiver's Prongs are placed snugly against your dog's skin. Refer to "Fitting the Receiver" on page 14 for more information.

2. The Receiver will not turn on.

- ◆ Make sure the Receiver has been charged. For the initial charge, be sure to charge it for 4 hours. Subsequent charges only take 2-3 hours.

3. The Receiver is not responding to the Remote Transmitter.

- ◆ Verify the Receiver is on.
- ◆ If the indicator is blinking rapidly, fully charge the Receiver.
- ◆ If the first two solutions did not resolve your problems, please check the "Pairing Up" section on page 13.

XIII. FCC Statement

USA

This device complies with part 15 of the FCC Rules.

Operation is subject to the following two conditions: (1) This device may not cause harmful interference, and (2) this device must accept any interference received, including interference that may cause undesired operation.

NOTE:

This equipment has been tested and found to comply with the limits for a Class B digital device, pursuant to part 15 of the FCC Rules. These limits are designed to provide reasonable protection against harmful interference in a residential installation. This equipment generates, uses, and can radiate radio frequency energy and, if not installed and used in accordance with the instructions, may cause harmful interference to radio communications.

However, there is no guarantee that interference will not occur in a specific installation. If interference does occur to radio or television reception, which can be determined by turning the equipment off and on, the user is encouraged to try to correct the interference by one or more of the following measures:

- Reorient or relocate the receiving antenna.
Increase the separation between the equipment and the receiver.
- Connect the equipment to an outlet on a circuit different from that to which the receiver is connected.
- Consult customer care, the dealer, or an experienced radio/TV technician for help.

intentional or unintentional radiator changes or modifications not expressly approved by the party responsible for compliance could void the user's authority to operate the equipment.

The device has been evaluated to meet general RF exposure requirement.

Model: VS8
Made in China
Version: V1.0