

5. Switching Channels

Press the On/Off (Channel) Button to choose the Receiver you want to control if you have paired up two Receivers.

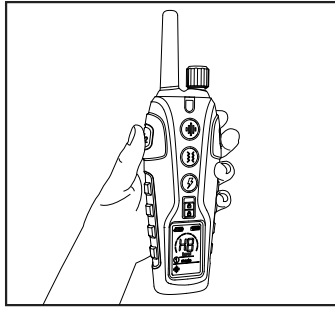

Press

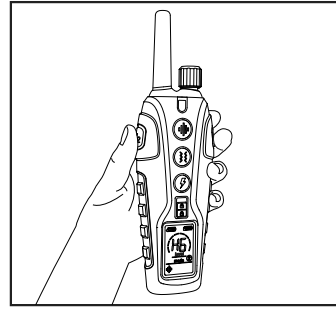

6. Sleep Mode

The Remote Transmitter will go into the sleep mode if no operation in one minute saving battery power.

VII. Fitting the Receiver

IMPORTANT:

The proper fit and placement of your Receiver are important for effective training. The Contact Points with Conductive Silicone Cover must have direct contact with your dog's skin on the underside of his neck. To assure a proper fit, please follow these steps:

1. Make sure that the Receiver is turned off.
2. Let your dog stand on four feet or lay down fully (A).
3. Place the Receiver on your dog's neck close to the ears. Center the Contact Points underneath your dog's neck, touching the skin (B).

Note: It is sometimes necessary to trim the hair around the Contact Points to make sure that contact is consistent.

4. The Receiver should fit snugly, yet loose enough to allow one finger to fit between the strap and your dog's neck (C).
5. Allow your dog to wear the collar for several minutes then recheck the fit. Check the fit again as your dog becomes more comfortable with the Receiver.

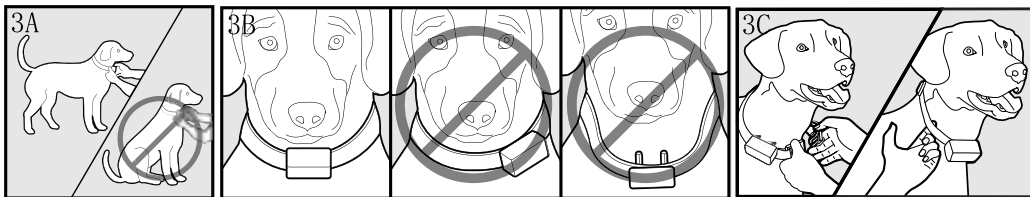

6. How to adjust the length of the collar?

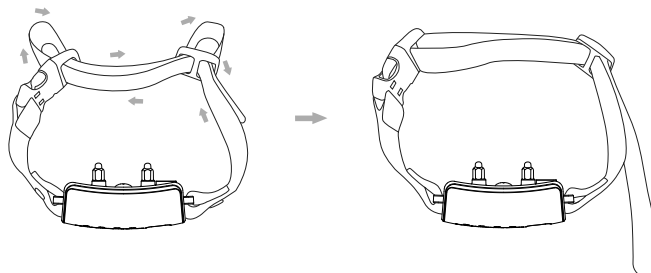

CAUTION:

Risk of Skin Damage. Too long time or too tightly fitting may cause pressure necroses, which are often misidentified as burns. Please follow the below instructions:

- Do not shave the dog's neck as this may increase the risk of skin irritation.
- Do not leave the Receiver on your dog's neck for continuous 12 hours.
- Never attach a leash to the collar.
- Never fit the Receiver too tight to your dog's neck.

VIII. Pairing Up

If you feel the Receiver is not responding to the Remote Transmitter, follow the following steps to pair them up.

1. Press and hold the Power Button on the Receiver for 3 seconds to turn it on. Turn on the Remote Transmitter by pressing the On/Off (Channel) Button for 2 seconds.

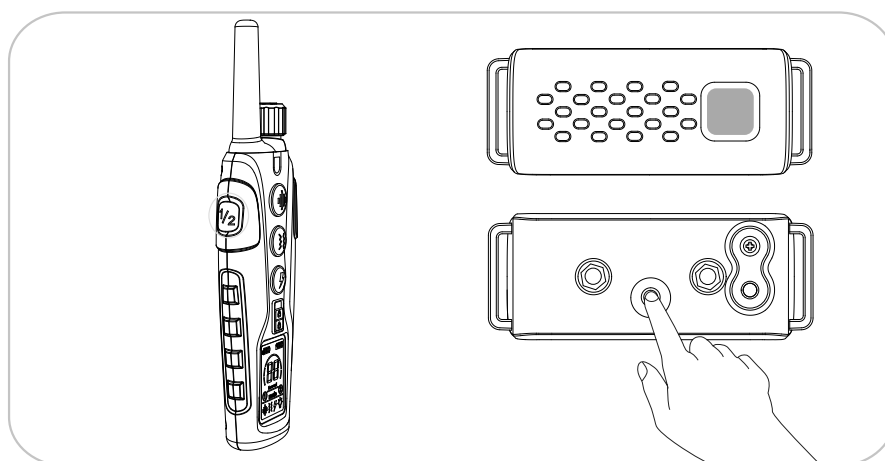

2. Press the Power Button on the Receiver 3 times to enter the Pairing Mode. You will hear a Beeping tone and the LED Indicator light becomes solid green. You will now have 10 seconds to finish the pairing.

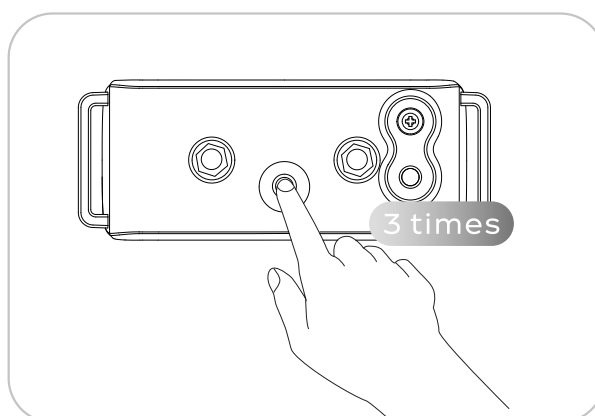

3. Press the Warning Tone Button, Vibration Button or Shock Button on the Remote Transmitter, and the Receiver will respond correspondingly indicating that the pairing process is completed.

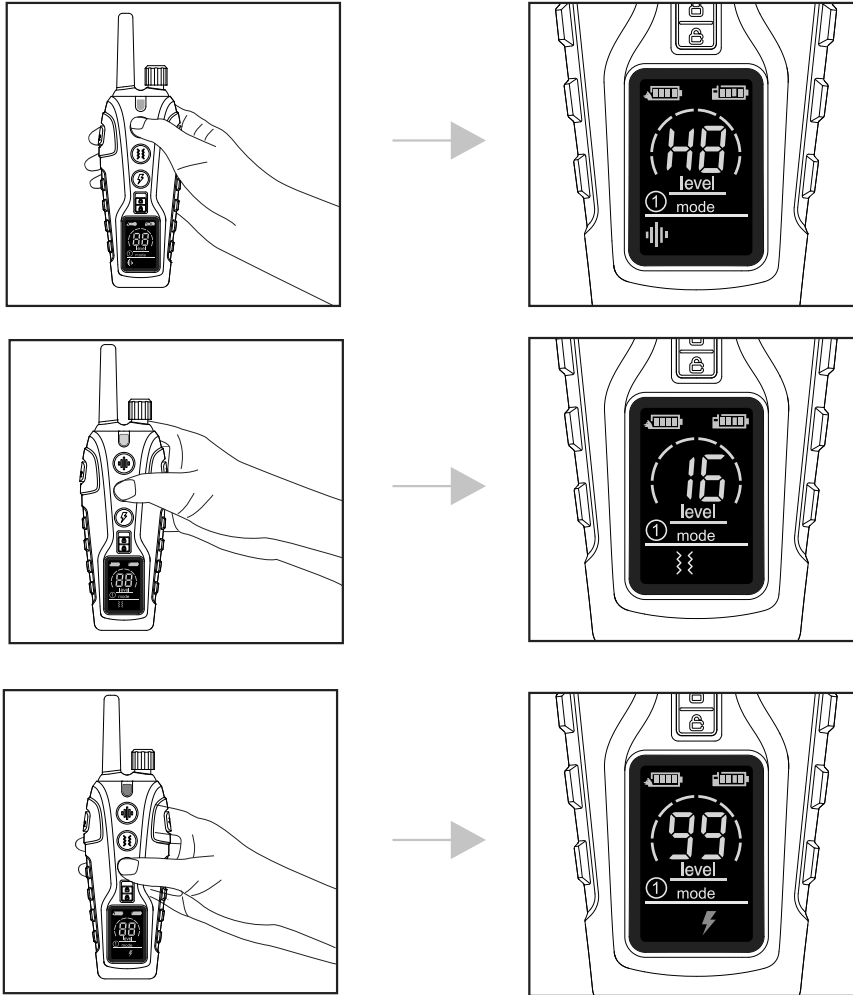





Tips:

The Receiver is paired up to the Remote Transmitter in Channel 1 by factory default setting. If you buy a new Receiver, you can follow the above instruction to pair it up to Channel 2. The system can pair up to 2 Receivers in 2 different channels. If you cannot pair your device successfully, it may be due to signal interference. Please try pairing again in a different location or contact our service center.

IX. LCD Display & Indicator Definitions

Remote Transmitter:

	Warning Tone Mode
	Vibration Mode
	Shock Mode
	Indicator Light
	Channel 1 and 2

	Level for Warning Tone/Vibration/Shock
	Remote Transmitter Battery
	Receiver Battery
	The Illuminating Light Mode
	The Positioning Light Mode

Remote Transmitter Indicator Light:

Charging	The Green Indicator light blinks slowly
Fully Charged	The Green Indicator light becomes solid
Press	The Green Indicator light comes up
Press	The Green Indicator light comes up
Press	The Red Indicator light comes up

Receiver Indicator Light:

	Slowly blinking indicates the Receiver is on
	Fast blinking indicates the Receiver is on charge
	Faster blinking indicates the Receiver battery is low

X. Training Tip

HOW to find the best stimulation for your dog?

Important: Always start at the lowest level and work your way up. The Remote Training Collar has 8 types of Warning Tones, 16 levels of Vibration, and 99 levels of Shock. For Warning Tones, there are 8 types of Tones, with only frequency differences between the different types. For Vibration and Shock, level 1 is the lowest level; the highest level for Vibration is level 16, and level 99 for Shock.

This allows you to choose the Stimulation level best for your dog. Once you have placed the Receiver on your dog, it is time to find the Stimulation Level best for him. This is called the Recognition Level.

A slight change in your dog's behavior, such as looking around in curiosity, scratching at his collar, or flicking his ears, indicates the Recognition Level that is best for your dog.

Follow the steps below to find your dog's Recognition Level:

1. Starting at Level 1, press the Warning Tone/Vibration/Shock Button continuously for 1 to 2 seconds. Note: When the Warning Tone/Vibration/Shock Button is held down for 10 consecutive seconds, the Remote Transmitter will "time out", and you must release and press the button again before additional stimulation can be delivered.

2. If your dog shows no reaction, repeat the Stimulation Level several times before moving up to the next level.

3. YOUR DOG SHOULD NOT VOCALIZE OR PANIC WHEN RECEIVING STIMULATION. IF THIS HAPPENS, THE STIMULATION LEVEL IS TOO HIGH AND YOU NEED TO GO BACK TO THE PREVIOUS LEVEL AND REPEAT THE PROCESS.

4. Move up through the Stimulation Levels until your dog reliably responds to the stimulation.

5. If your dog continues to show no response at the highest level of Vibration or Static Shock, check the fit of the Receiver. If your dog has long or thick hair, contact our Customer Care Center to obtain a longer set of Contact Points. Then go back to #1 and repeat the process.

If this still does not yield any results, your dog's hair will need to be trimmed around the Contact Points. If after completing all of these steps, your dog still does not indicate he is feeling the stimulation, please contact our customer service.

How to Maximize the distance?

Terrain, weather, vegetation, transmission from other radio devices, and other factors will affect the maximum range.

Hold the Remote Transmitter in a horizontal position away from your body to achieve optimum range. For maximum signal strength, keep the device properly charged.

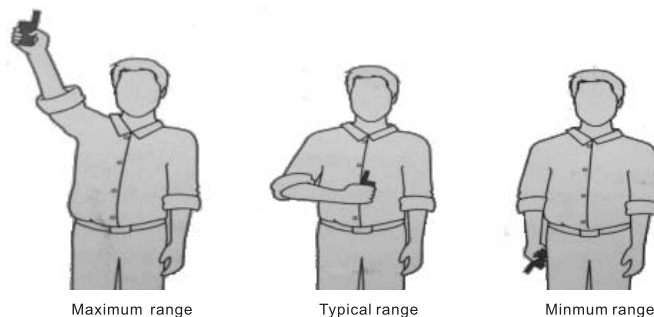

*Avoid touching the antenna or the range may decrease substantially.

Frequently Asked Questions

Q: Is the Stimulation safe for my dog?

A: While the Stimulation is unpleasant, it is harmless to your dog. Electronic training devices require interaction and training from the owner to achieve desired results.

Q: How old does my dog have to be before using the Remote Training Collar?

A: Your dog should be able to recognize basic obedience commands such as "Sit" or "Stay". Dogs should be at least 6 months old before using the Trainer.

Q: Once my dog is trained and has been obeying my commands, will he have to continue to wear the Receiver?

A: Probably not. You may need to reinforce training with the Receiver from time to time.

Q: Is the Receiver waterproof?

A: Yes. The Receiver meets IP67 waterproof rating, but make sure to keep the area dry when charging.

Note: the Remote Transmitter is not waterproof.

Q: Will I get a maximum range with the Remote Training Collar?

A: The range of the Remote Training Collar will vary according to terrain, weather, vegetation, as well as transmission from other radio devices. See "How to Maximize the Distance" on page 17 for tips on maximizing your range.

Q: How long can I continuously deliver stimulation to my dog?

A: The maximum amount of time you can press the Warning Tone /Vibration/Shock button and deliver stimulation to your dog continuously is 10 seconds. After this, the Remote Transmitter will time out, and these stimulation buttons must be released and pressed again.

Trouble Shooting

1. My dog does not respond when I press a button.

- Make sure the Receiver has been turned on.
- If your range has reduced from the first time you used the Remote Training Collar, the battery may be low in either the Remote Transmitter or the Receiver.
- Many factors can impact the amount of range you have with the Remote Trainer. For a list of these factors, see "How to Maximize the Distance" on page 17.
- Test the Receiver with the Test Bulb Tool.
 - Turn the Receiver on.
 - Hold the Test Bulb Tool to the Contact Points on the Receiver.
 - Press the Shock Button on the Remote Transmitter.
 - The Test Light will flash. At higher shock levels, the Test Bulb Tool will flash brighter.

NOTE: If the Test Bulb Tool does not flash, recharge the Receiver and re-test. If the Test Bulb Tool still does not flash, contact our Customer Care Center .

- Increase the Stimulation Level. Refer to "HOW to find the best stimulation for your dog?" on page 17 for more information.
- Make sure the Receiver's Contact Points are placed snugly against your dog's skin. Refer to "Fitting the Receiver" on page 13 for more information.

2.The Receiver will not turn on.

- Make sure the Receiver has been charged. For the initial charge, be sure to charge it for 4 hours. Subsequent charges only take 2~3 hours.

3.The Receiver is not responding to the Remote Transmitter.

- Verify the Receiver is on.
- If the indicator is blinking rapidly, fully charge the Receiver.
- If the above two solutions did not resolve the problem, please refer to “VIII. Pairing Up” on page 14 to re-pair the Receiver to the Remote Transmitter.

FCC Statement

USA

Any Changes or modifications not expressly approved by the party responsible for compliance could void the user's authority to operate the equipment.

NOTE:

This equipment has been tested and found to comply with the limits for a Class B digital device, pursuant to part 15 of the FCC Rules. These limits are designed to provide reasonable protection against harmful interference in a residential installation. This equipment generates uses and can radiate radio frequency energy and, if not installed and used in accordance with the instructions, may cause harmful interference to radio communications.

However, there is no guarantee that interference will not occur in a particular installation. If this equipment does cause harmful interference to radio or television reception, which can be determined by turning the equipment off and on, the user is encouraged to try to correct the interference by one or more of the following measures:

- Reorient or relocate the receiving antenna.
- Increase the separation between the equipment and receiver.
- Connect the equipment into an outlet on a circuit different from that to which the receiver is connected.
- Consult the dealer or an experienced radio/TV technician for help. The device has been evaluated to meet general RF exposure requirement. The device can be used in portable exposure condition without restriction.

This device complies with part 15 of the FCC Rules.

Operation is subject to the following two conditions:

- (1) This device may not cause harmful interference, and
- (2) this device must accept any interference received, including interference that may cause undesired operation.