

PAWPRO

SERIES ULTIMATE

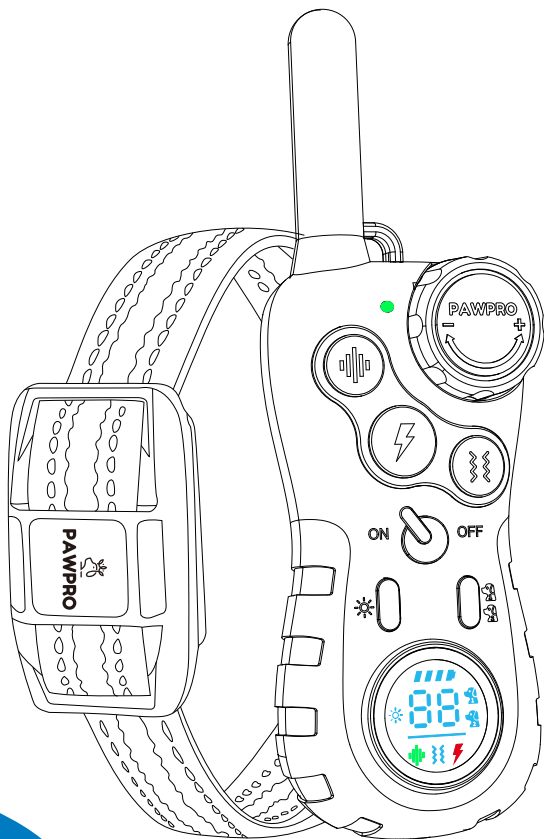

Introduction

Welcome to the PAWPRO family, and thank you for choosing the PAWPRO Ultimate Training Collar.

Our mission is to provide you with the most advanced and effective training tools to build a strong bond with your dog. This manual is designed to help you make the most of your new training collar, guiding you to eliminate unwanted behaviors and cultivate positive habits in your dog. Please read it thoroughly before using the collar, and ensure anyone else who uses it does the same.

The PAWPRO Ultimate training system is engineered to establish a clear line of communication between you and your dog, offering greater freedom while keeping them safe. It's important to note that this system is intended for training and guidance, not punishment or harm.

Whether your dog is a beloved family pet, a dedicated working dog, or a skilled hunting companion, we all aspire to have a well-behaved dog that responds reliably to our commands, even in challenging environments.

With the PAWPRO Ultimate Collar, you have a powerful tool at your disposal. This collar allows you to deliver commands and stimulation remotely, ensuring your dog receives the right cues at the right times. The adjustable intensity levels enable you to customize the stimulation to suit your dog's temperament and the current level of distraction, ensuring effective and humane training.

Thank you for trusting PAWPRO with your dog's training. Together, we can help your dog become the best they can be.

User Testimonials and Observed Benefits

In the introduction of this manual, it is important to highlight the tangible improvements observed by users of the PAWPRO training collar. User feedback reveals a significant impact on managing undesirable behaviors, with notable effectiveness in gentle correction and improving responses to commands.

Dog owners have praised the convenience of the PAWPRO collar, emphasizing how it has simplified communication with their four-legged companions. Behavior issues such as recall, excessive agitation, or jumping have been successfully addressed, providing harmonious cohabitation and strengthening the bond between humans and animals.

The observed benefits extend beyond educational effectiveness, also impacting the well-being of dogs. Users report that their pets appear more confident, less stressed, and have developed a deep understanding of expectations, thereby establishing an environment conducive to lasting learning.

Commitment to Excellence

Our collars are designed with the highest quality materials and cutting-edge technology to ensure durability, comfort, and effectiveness. We understand that each dog is unique, which is why the PAWPRO Ultimate Model features customizable settings to match your dog's specific needs. From the largest range in the market to the intuitive LCD color display, every feature is crafted to provide you with precise control and exceptional results.

Register Your Warranty

To ensure you receive the full benefits of your PAWPRO ULTIMATE training collar, we invite you to register your product warranty. Registering your warranty helps us provide you with the best customer support and service, ensuring your investment is protected.

How to Register:

Simply scan the QR code below with your smartphone or tablet to be taken directly to our warranty registration page, where you can complete the process in just a few easy steps.



Alternatively, you can register your warranty at: www.pawproshop.com/warranty.

Free PAWPRO Training Guide

To further support your training journey, we are pleased to offer a comprehensive Free Training Guide. This guide is designed to help you make the most of your PAWPRO ULTIMATE training collar, providing expert tips and techniques for effective and humane dog training.

Our Free Training Guide covers a wide range of topics, including:

- Basic Obedience Training
- Advanced Commands
- Addressing Common Behavioral Issues
- Tips for Consistent Training
- Positive Reinforcement Strategies

Whether you are a novice or an experienced trainer, this guide offers valuable insights to help you achieve the best results with your dog.

How to Access the Free Training Guide:

You can easily download the Free Training Guide by scanning the QR code below with your smartphone or tablet. This will direct you to our online resource center where you can access the guide and other helpful training materials.



You can also download the guide at: www.pawproshop.com/guide.

I. Important Safety Information:

WARNING

Not for use with aggressive dogs. Do not use this product if your dog is aggressive or if your dog is prone to aggressive behavior. Aggressive dogs can cause severe injury to their owner and others. If you are unsure whether this product is appropriate for your dog, please consult your veterinarian or a certified trainer.

- ◆ For use with dogs over 6 months of age and over 5 lbs.
- ◆ **DO NOT** press and hold the Warning Tone Button, Vibration Button and Shock Button for more than 10 seconds constantly to avoid physical or psychological hurt to your dog.
- ◆ Your dog **SHOULD NOT VOCALIZE OR PANIC** when receiving stimulation. If this happens, the stimulation level is too high and you need to go back to the previous level and repeat the process.
- ◆ **DO NOT** charge the device near any flammable substances.
- ◆ For dog use **ONLY**. Not for use on children.
- ◆ This is not a toy, and should only be operated by a responsible adult.

CAUTION

Before your first training, please read and follow the instructions in this manual carefully. The cautions below will help keep your dog safe and comfortable. Millions of dogs are comfortable when they wear stainless steel contacts, while some dogs are sensitive to contact pressure.

- ◆ **It is vitally important that you and your dog remain safe while learning during on-leash training.** Your dog should be on a strong leash (do not attach the leash to the Training Collar), long enough for him to attempt to chase an object, but short enough for him not to reach a road or other hazard. You must also be physically strong enough to restrain your dog when he tries to chase.
- ◆ **Risk of skin damage.** Proper Collar fitment is important. A Collar worn for too long or made too tight on the dog's neck may cause skin damage. Ranging from redness to pressure ulcers; this condition is commonly known as bed sores.
- ◆ **DO NOT leave the Collar on the dog for more than 12 hours per day.**
- ◆ When possible **re-position the Collar on the dog's neck every 1 to 2 hours.**
- ◆ **Check the fit to prevent excessive pressure;** follow the instructions in this manual.
- ◆ **Never connect an extra leash to the Collar;** it will cause excessive pressure on the contacts.
- ◆ **Clean the dog's neck area and the Metal Prongs of the Collar weekly** with a damp cloth.
- ◆ **Examine the contact area daily** for signs of a rash or a sore.
- ◆ **If a rash or sore is found, discontinue use of the Collar** until the skin has healed. If the condition persists beyond 48 hours, see your veterinarian.
- ◆ The Receiver meets IP67 waterproof rating, it can be submerged in water up to 1 meter for up to 30 minutes.
- ◆ This product comes with conductive silicone caps, please ensure they are worn on the Metal Prongs before putting the Receiver on your dog and check for the presence of the Conductive Silicone Caps.

II. Quick Start Guide

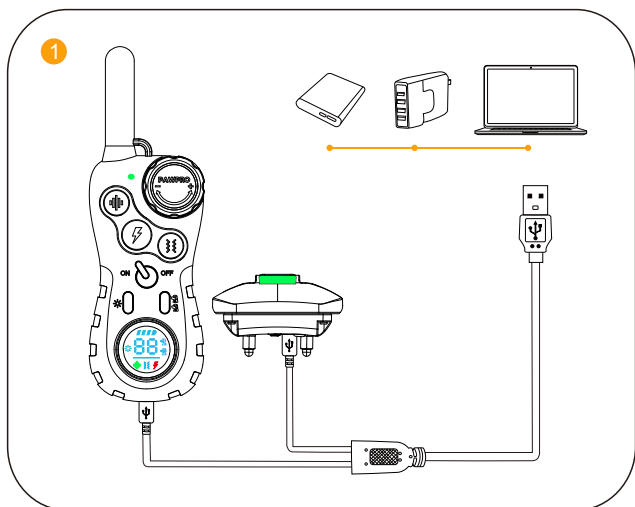

Charge the Receiver and the Remote Transmitter for 2-3 hours with the double-headed Micro-USB cable from the package box.

Note: The charger, power bank and other charging devices shown in the above picture are not included in the box.

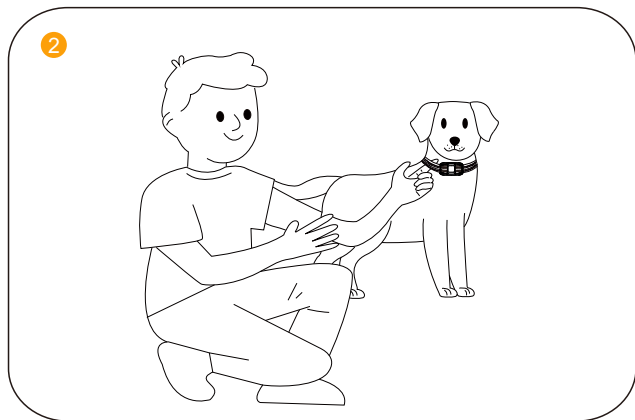

Let your dog stand on four feet or lay down fully. Fit the Receiver to your dog by leaving one finger space between the Collar and your dog's neck. Center the Metal Prongs underneath your dog's neck, touching the skin.

3

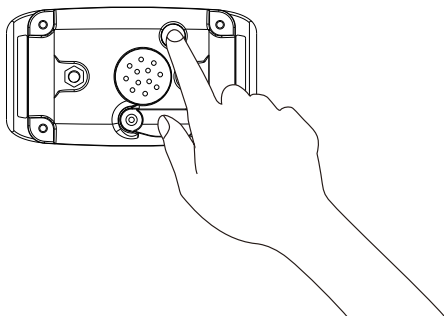

Turn on the Receiver by pressing and holding the Power Button for 2 seconds with a vibration to indicate that the Receiver turns on, and then the green LED Indicator continues to blink regularly.

4

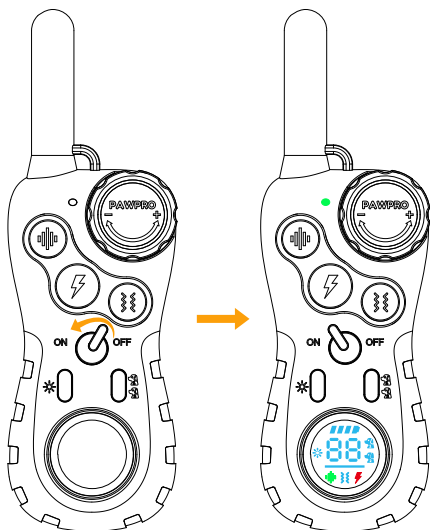

Turn on the Remote Transmitter by turning the On/Off Button to the "On" side.

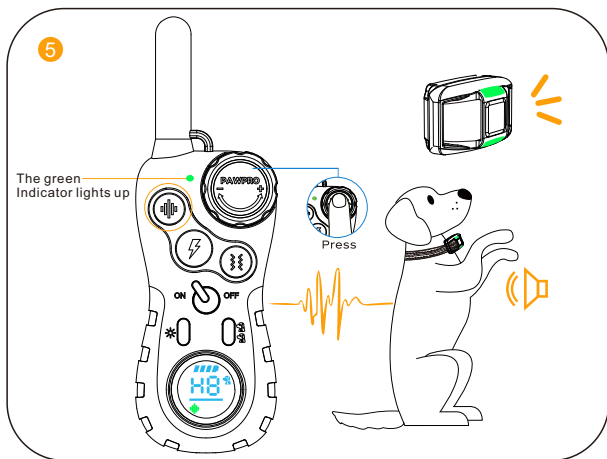

Warning Tone Command: Press the Warning Tone Button, and the green Indicator Light on the Remote Transmitter rapidly lights up. The Receiver will deliver a Warning Tone, and the green LED Indicator light on the Receiver comes up simultaneously.

To adjust the Warning Tone Level, press the Adjustment Knob to select the Warning Tone Mode first, then turn the Adjustment Knob left and right to lower/raise to the desired level, and finally press any button (⊕/⊖/⊙) to confirm the modification.

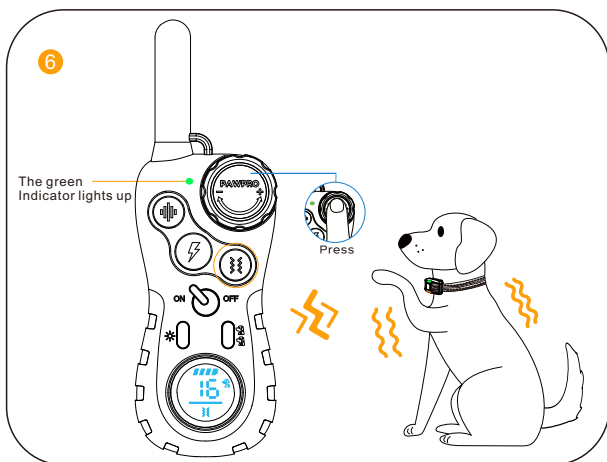

Vibration Command: Press the Vibration Button, and the green Indicator Light on the Remote Transmitter rapidly lights up. The Receiver will deliver Vibration, and the green LED Indicator light on the Receiver comes up simultaneously.

To adjust the Vibration Level, press the Adjustment Knob to select the Vibration Mode first, then turn the Adjustment Knob left and right to lower/raise to the desired level, and finally press any button (⊕/⊖/⊙) to confirm the modification.

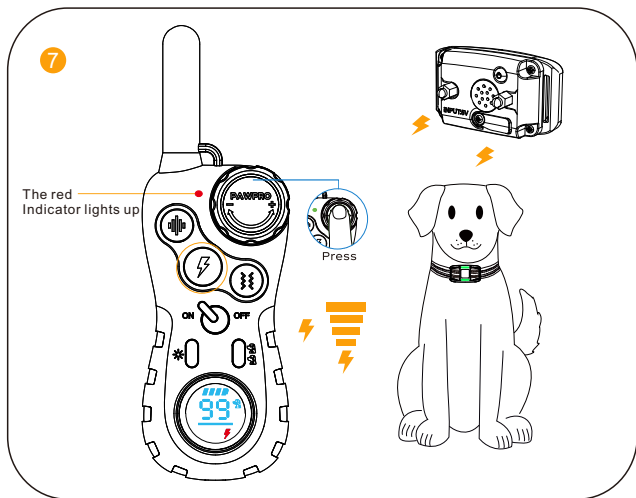

To adjust the shock level, press the Adjustment Knob to select the Shock Mode first, then turn the Adjustment Knob left and right to lower/raise to the desired level, and finally press any button (⊕/⊖/⊙) to confirm the modification.

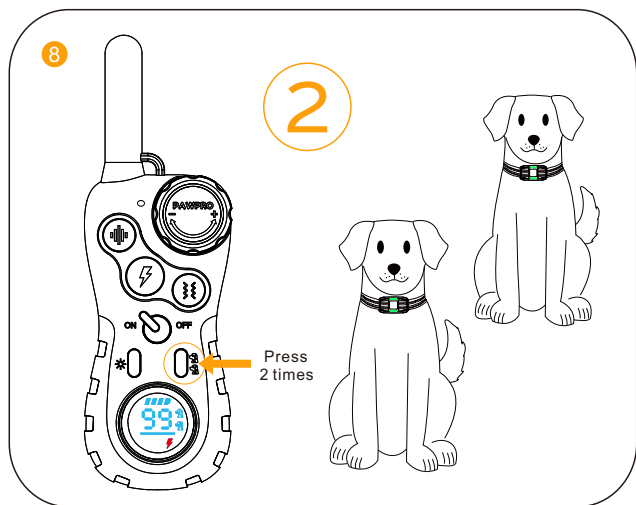

Switch the channel by pressing the Channel Button twice consecutively. This Training Collar can train to 2 dogs.

9



Steps to pair the Remote Transmitter to the Receiver:

1. Press and hold the Power Button on the Receiver for 2 seconds to turn it on. Turn on the Remote Transmitter by turning the On/Off Button to the "On" side;
2. Press the Power Button on the Receiver 3 times to enter the Pairing Mode. You will hear a beeping tone and the Indicator becomes solid green. You will now have 10 seconds to finish the pairing;
3. Press the Warning Tone Button, Vibration Button, or Shock Button on the Remote Transmitter, and Receiver will respond correspondingly indicating that the pairing process is completed. Please refer to "[VI. Pairing Up](#)" on [page 15](#) for more details.

Purchase a Second Collar

If you have a second dog, you can easily pair an additional collar to your remote.

By purchasing an extra collar from our website: www.pawproshop.com, you can control two dogs simultaneously with a single remote. This feature provides convenience and efficiency, allowing you to manage both dogs training with ease.

10

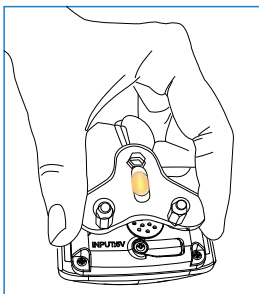
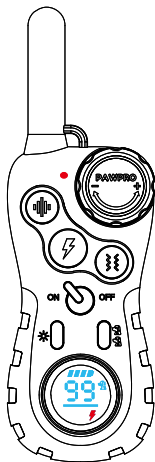

Test the Receiver with the Test Bulb:

1. Turn the Receiver on.
2. Hold the Test Bulb to the Metal Prongs on the Receiver. Make sure the metal wire in the Test Bulb has direct contact with both of the top of the Metal Prongs.
3. Press the Shock Button on the Remote Transmitter.
4. The yellow Test Light will flash if the Receiver works normally. At higher shock levels, the Test Bulb will flash brighter.

Note:

- (1) While you test the Receiver with your fingers, please put your two fingers on the top of the Metal Prongs separately to form a closed loop circle.
- (2) Please always start from the lowest Shock level to avoid accident hurt.

Customer Support

Our customer support team is here to assist you with any questions or concerns you may have about your PAWPRO ULTIMATE training collar. We are committed to providing you with the best service possible. If you need assistance, please do not hesitate to contact us at help@pawproshop.com.

III. Package Content



Remote Transmitter



Receiver

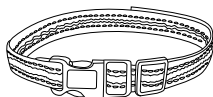

Collar



Metal Prongs



Test Bulb



Conductive Silicone Caps



User Manual



Wrist Strap

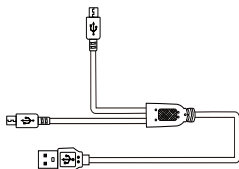

Charging Cable

IV. Product Overview

Receiver

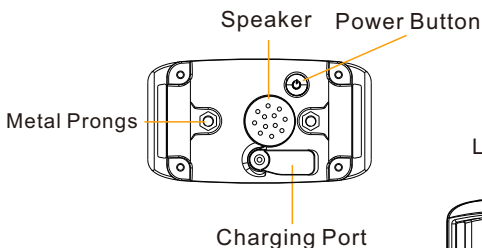

LED Indicator

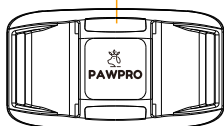

Remote Transmitter

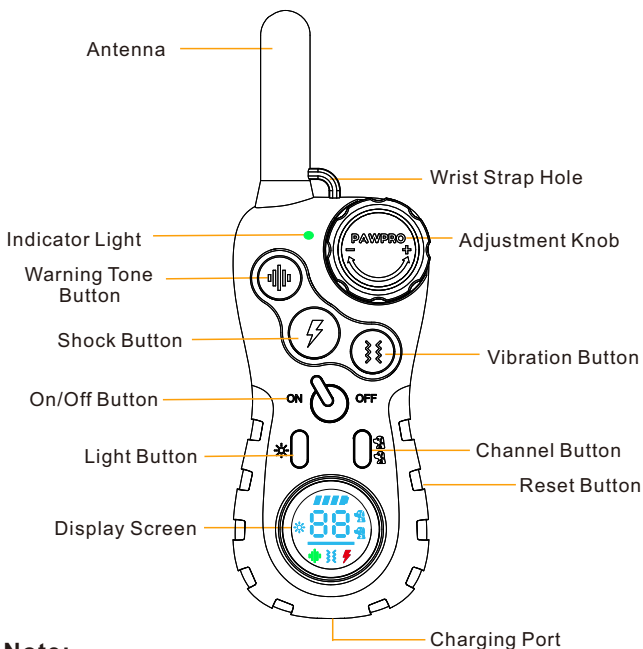

Note:

The Remote Transmitter will go into sleep mode if there is no operation in 20 seconds.

The Remote Transmitter will reboot if you trigger the Reset Button, while the parameters of training modes you set are retained.

Display Screen

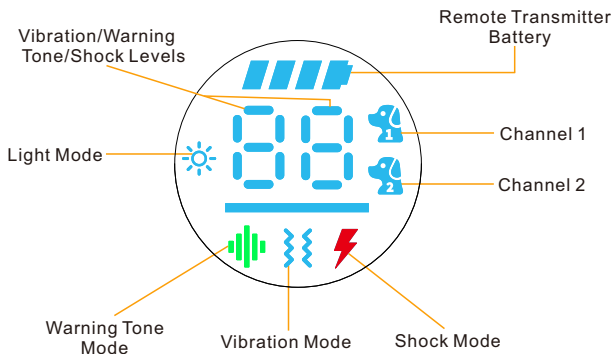

How the system works?

The Remote Training Collar is easy to use with an advanced digital display that tells you the exact stimulation level you are using.

The Remote Training Collar assists you in controlling your dog without a leash. At the push of a button, your Remote Transmitter sends a signal activating your dog's Receiver. He receives a safe but annoying stimulation. He'll quickly learn the association between his behavior and your correction, and soon you'll have a better-behaved dog.

The Remote Training Collar has been proven safe, comfortable, and effective for both small and large dog breeds.

If using the Remote Training Collar consistently and correctly, any basic obedience commands can be taught and will help correct any misbehavior that your dog exhibits.

V. Setting Up

1. Charge the Product

Charge both the Receiver and the Remote Transmitter with the Charging Cable in the package box until their Indicator becomes solid green which will take around 2-3 hours.

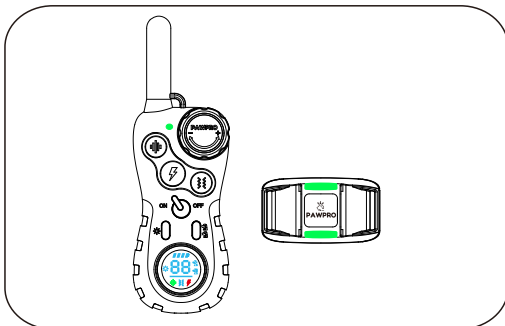
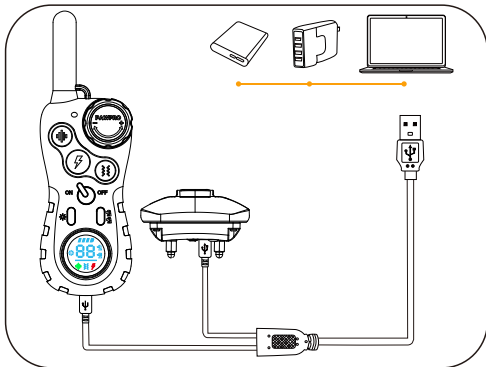

Note:

- (1)The charger, power bank and other charging devices shown in the above picture are not included in the package box.
- (2)Use the Charging Cable in the package box when charging. Other charging cables may not be suitable for this Receiver and Remote Transmitter, which may cause electric damage.
- (3)The Remote Training Collar **ONLY** supports a **5V-rated power source**. If charged with an improper charger:
Receiver—deliver a rapid warning tone and stop charging automatically.
Remote Transmitter—stop charging automatically with the Indicator rapidly blinking in red.

2. Turn On/Off the Product

Turn on the Remote Transmitter by turning the On/Off Button to the “On” side;

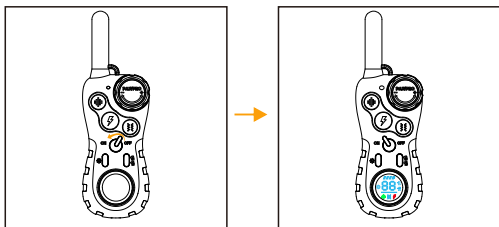

Turn off the Remote Transmitter by turning the On/Off Button to the “Off” side.

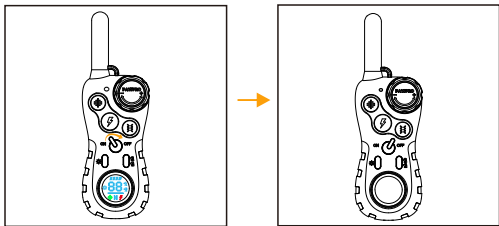

Turn on the Receiver by pressing and holding the Power Button for 2 seconds with vibration, as the green LED Indicator light blinks regularly.

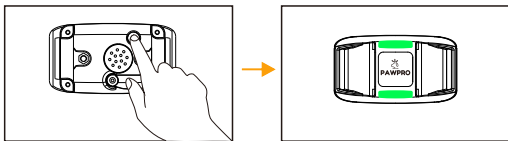

Turn off the Receiver by pressing and holding the Power Button for 2 seconds with a long beeping, as the green LED Indicator light stops blinking.

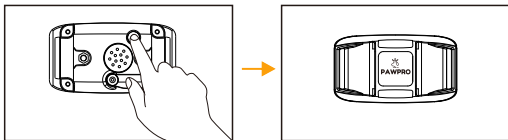

VI. Training Modes

1. Warning Tone Mode

Press the Warning Tone Button and the Receiver will deliver a warning tone. It will cut off automatically if you press and hold the Warning Tone Button for 10 seconds. There is a total of 8 levels of Warning Tone.

To adjust the warning tone level, press the Adjustment Knob to select the Warning Tone Mode first, then turn the Adjustment Knob left and right to lower/raise to the desired level, and finally press any button (⊕/⊞/⊗) to confirm the modification.

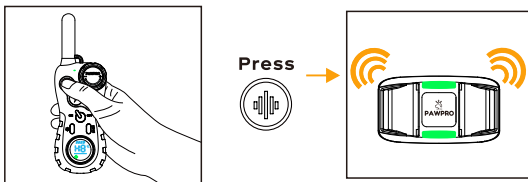

2. Vibration Mode

Press the Vibration Button and the Receiver will deliver a vibration. It will cut off automatically if you press and hold the Vibration Button for 10 seconds. There is a total of 16 levels of Vibration.

To adjust the vibration level, press the Adjustment Knob to select the Vibration Mode first, then turn the Adjustment Knob left and right to lower/raise to the desired level, and finally press any button (⊕/⊞/⊗) to confirm the modification.

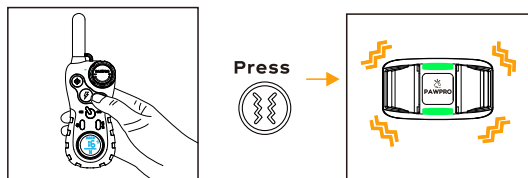

3. Shock Mode

Press the Shock Button and the Receiver will deliver a static shock. It will cut off automatically if you press and hold the Shock Button for 10 seconds. There is a total of 99 levels of Shock.

To adjust the shock level, press the Adjustment Knob to select the Shock Mode first, then turn the Adjustment Knob left and right to lower/raise to the desired level, and finally press any button (⊕/⊞/⊗) to confirm the modification.

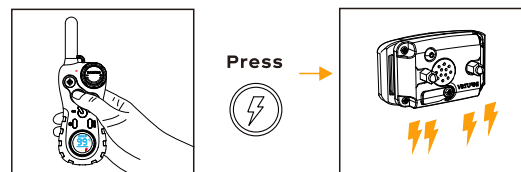

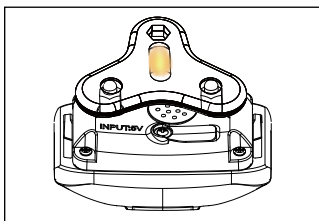

When testing the Shock for the first time, place the Test Bulb on the Metal Prongs. The Test Bulb lights up to indicate that the Shock is working, and it will become brighter at higher shock levels.

4. Light Mode

Press and hold the Light Button, the Illuminating Light on the Receiver will be on, while the "L1" icon is shown on the Remote Transmitter. Once release the Light Button, the Illuminating Light on the Receiver will be off.

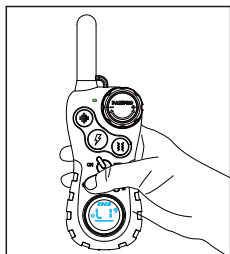

Press
and hold



5. Switching Channels

Press the Channel Button twice consecutively to choose the Receiver you want to control if you have paired up two Receivers.

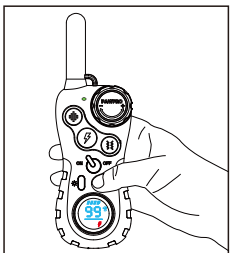

Press 2 times



Reminder:
Press 2 times to
switch the
channels

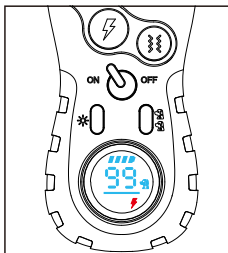

Note:

The Remote Transmitter will go into the sleep mode if no operation in 20 seconds to saving battery power.

VII. Fitting the Receiver

IMPORTANT:

The proper fit and placement of your Receiver are important for effective training. The Metal Prongs with Silicone Caps must have direct contact with your dog's skin on the underside of his neck. To assure a proper fit, please follow these steps:

1. Make sure that the Receiver is turned off.
2. Let your dog stand on four feet or lay down fully (A).
3. Place the Receiver on your dog's neck close to the ears. Center the Metal Prongs underneath your dog's neck, touching the skin (B).
Note: It is sometimes necessary to trim the hair around the Metal Prongs to make sure that contact is consistent.
4. The Receiver should fit snugly, yet loose enough to allow one finger to fit between the strap and your dog's neck (C).
5. Allow your dog to wear the Receiver for several minutes then recheck the fit. Check the fit again as your dog becomes more comfortable with the Receiver.

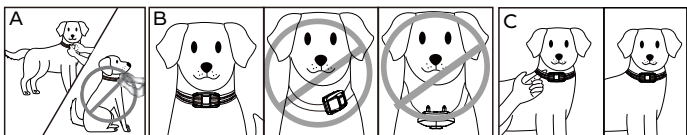

6. To attach the collar to the Receiver, please follow the following steps as instructed to thread the strap.

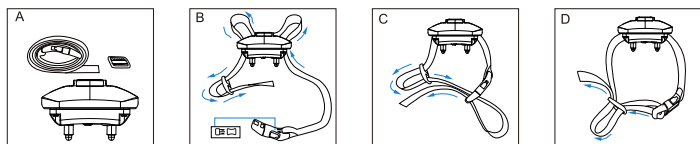

CAUTION:

Risk of Skin Damage. Wearing the collar too long or fitting the collar too tight may cause pressure necroses, which are often misidentified as burns. Please follow the below instructions to avoid pressure necroses:

- **DO NOT** shave the dog's neck as this may increase the risk of skin irritation.
- **DO NOT** leave the Receiver on your dog's neck for continuous 12 hours.
- **NEVER** attach an extra leash to the collar.
- **NEVER** fit the Receiver too tight to your dog's neck.

VIII. Pairing Up

In case of the Receiver is not responding to the Remote Transmitter, follow these steps to pair them up:

1. Press and hold the Power Button on the Receiver for 2 seconds to turn it on. Turn on the Remote Transmitter by turning the On/Off Button to the "On" side.

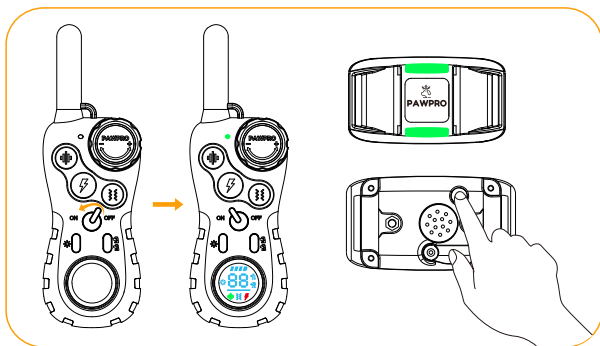

2. Press the Power Button on the Receiver 3 times to enter the Pairing Mode. You will hear a Beeping tone and the LED Indicator light becomes solid green. You will now have 10 seconds to finish the pairing.

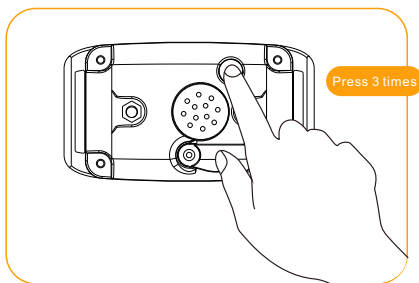

3. Press the Warning Tone Button, Vibration Button or Shock Button on the Remote Transmitter, and the Receiver will respond respectively indicating that the pairing process is completed.

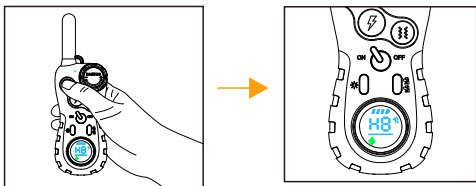

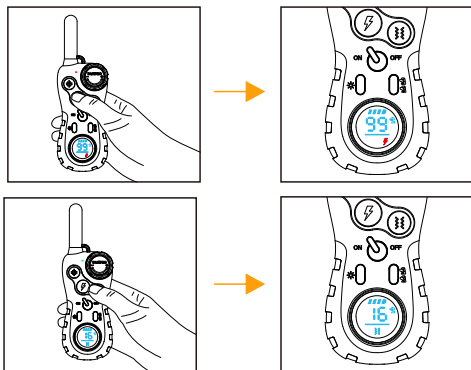



Tips:



The Receiver is paired up to the Remote Transmitter in Channel 1 by factory default setting. If you buy a new Receiver, you can follow the above instruction to pair it up to Channel 2. The system can pair up to 2 Receivers in 2 different channels. If you cannot pair your device successfully, it may be due to signal interference. Please try pairing again in a different location or contact our service center via email: help@pawproshop.com.

IX. Indicator Definitions

Remote Transmitter Indicator :

Charging	The Green Indicator light blinks slowly
Fully Charged	The Green Indicator light becomes solid
Press 	A Green Indicator light comes up
Press 	A Green Indicator light comes up
Press 	A Red Indicator light comes up

Receiver Indicator:

	Slowly blinking indicates the Receiver is on
	Fast blinking indicates the Receiver is on charge
	Faster blinking indicates the Receiver battery is low
	Light Mode is on

X. Training Tip

Important: Always start at the lowest level and work your way up. The Remote Training Collar has 8 types of Warning Tones, 16 levels of Vibration, and 99 levels of Shock. For Warning Tones, there are 8 types of Tones, with only frequency differences between the different types. For Vibration and Shock, level 1 is the lowest; the highest level for Vibration is level 16, and level 99 for Shock.

This allows you to choose the Stimulation level that is best for your dog. Once you have placed the Receiver on your dog, it is time to find the Stimulation Level that is best for him. This is called the Recognition Level.

A slight change in your dog's behavior, such as looking around in curiosity, scratching at his collar, or flicking his ears, indicates the Recognition Level that is best for your dog.

Follow the steps below to find your dog's Recognition Level:

1. Starting at Level 1, press the Warning Tone/Vibration/Shock Button continuously for 1 to 2 seconds.

Note: When the Warning Tone/Vibration/Shock Button is held down for 10 consecutive seconds, the Remote Transmitter will "time out", and you must release and press the button again before additional stimulation can be delivered.

2. If your dog shows no reaction, repeat the Stimulation Level several times before moving up to the next level.

3. YOUR DOG SHOULD NOT VOCALIZE OR PANIC WHEN RECEIVING STIMULATION. IF THIS HAPPENS, THE STIMULATION LEVEL IS TOO HIGH AND YOU NEED TO GO BACK TO THE PREVIOUS LEVEL AND REPEAT THE PROCESS.

4. Move up through the Stimulation Levels until your dog reliably responds to the stimulation.

5. If your dog continues to show no response at the highest level of Vibration or Static Shock, check the fit of the Receiver. If your dog has long or thick hair, contact our Customer Care Center to obtain a longer set of Metal Prongs. Then go back to Level 1 and repeat the process. If this still does not yield any results, your dog's hair will need to be trimmed around the Metal Prongs.

If after completing all of these steps, your dog still does not indicate he is feeling the stimulation, please contact our customer service.

How to Maximize the distance?

Terrain, weather, vegetation, transmission from other radio devices, and other factors will affect the maximum range.

Hold the Remote Transmitter in a horizontal position away from your body to achieve optimum range. For maximum signal strength, keep the device properly charged.



Maximum range



Typical range



Minimum range

*Avoid touching the antenna or the range may decrease substantially.

XI. Frequently Asked Questions

Q: Is the Stimulation safe for my dog?

A: While the Stimulation is unpleasant, it is harmless to your dog. Electronic training devices require interaction and training from the owner to achieve desired results.

Q: How old does my dog have to be before using the Remote Training Collar?

A: Your dog should be able to recognize basic obedience commands such as "Sit" or "Stay". Dogs should be at least 6 months old before using the Remote Training Collar.

Q: Once my dog is trained and has been obeying my commands, will he have to continue to wear the Receiver?

A: Probably not. You may need to reinforce training with the Receiver from time to time.

Q: Is the Receiver waterproof?

A: Yes. The Receiver meets the IP67 waterproof rating, but make sure to keep the area dry when charging.

Note: Remote Transmitter is not waterproof.

Q: Will I get a maximum range with the Remote Training Collar?

A: The range of the Remote Training Collar will vary according to terrain, weather, vegetation, as well as transmission from other radio devices.

See "How to Maximize the Distance" on page 17 for tips on maximizing your range.

Q: How long can I continuously deliver stimulation to my dog?

A: The maximum amount of time you can press the Warning Tone/Vibration/ Shock button and deliver stimulation to your dog continuously is 10 seconds. After this, the Remote Transmitter will time out, and these stimulation buttons must be released and pressed again.

XII. Trouble Shooting

1. My dog does not respond when I press a button.

- Make sure the Receiver has been turned on.
- If your range has reduced from the first time you used the Remote Training Collar, the battery(-ies) may be low in either the Remote Transmitter or Receiver.
- Many factors can impact the amount of range. For a list of these factors, see "How to Maximize the Distance" on page 17.
- Test the Receiver with the Test Bulb.

NOTE: If the Test Bulb does not flash, recharge the Receiver and re-test. If the Test Bulb still does not flash, please contact our customer service.

- Increase the Stimulation Level. Refer to "Find the best stimulation for your dog" on page 17 for more information.
- Make sure the Receiver's Metal Prongs are placed snugly against your dog's skin. Refer to "Fitting the Receiver" on page 14 for more information.

2.The Receiver will not turn on.

- Make sure the Receiver has been charged. For the initial charge, be sure to charge it for 4 hours. Subsequent charges only take 2-3 hours.

3.The Receiver is not responding to the Remote Transmitter.

- Verify the Receiver is on.
- If the indicator is blinking rapidly, fully charge the Receiver.
- If the first two solutions did not resolve your problems, please check the “How to pair the Remote Transmitter & Receiver” section.

XIII. FCC Statement

USA

This device complies with part 15 of the FCC Rules. Operation is subject to the following two conditions: (1) This device may not cause harmful interference, and (2) this device must accept any interference received, including interference that may cause undesired operation.

NOTE:

This equipment has been tested and found to comply with the limits for a Class B digital device, pursuant to part 15 of the FCC Rules. These limits are designed to provide reasonable protection against harmful interference in a residential installation. This equipment generates, uses, and can radiate radio frequency energy and, if not installed and used in accordance with the instructions, may cause harmful interference to radio communications.

However, there is no guarantee that interference will not occur in a specific installation. If interference does occur to radio or television reception, which can be determined by turning the equipment off and on, the user is encouraged to try to correct the interference by one or more of the following measures:

- Reorient or relocate the receiving antenna.
- Increase the separation between the equipment and the receiver.
- Connect the equipment to an outlet on a circuit different from that to which the receiver is connected.
- Consult customer care, the dealer, or an experienced radio/TV technician for help.

Changes or modifications not expressly approved by the party responsible for compliance could void the user's authority to operate the equipment.

The device has been evaluated to meet general RF exposure requirement.

The device can be used in portable exposure condition without restriction.

Customer Support

Our customer support team is here to assist you with any questions or concerns you may have about your PAWPRO ULTIMATE training collar. We are committed to providing you with the best service possible. If you need assistance, please do not hesitate to contact us at help@pawproshop.com.

— SERIES —
ULTIMATE