Recognition book

SPECIFICATION FOR APPROVAL

Name: WIFI/BT 2.4/5.2G Antenna

Item No: TYT-TX2811

Customer name: Hangzhou Rongmeng Intelligent Technology Co. LTD

Company stamp: _____

drawing			Customer approve
MADE	CHECKED	APPROVED	
QIU	jack	Miketang	
DATE: 2023.04.19			DATE

1、Specifications

The report provides a test of the electrical performance parameters of the **TYY-TX2811** Technical parameters of antenna electrical appliances antenna, which is a science and technology model. **TYY-TX2811** WIFI Built in antenna, WIFI Antenna is made by copper pipe+RF Line composition. (As follows 1 Shown)

Electrical technical parameters			
电性能指标		Electrical Specifications	
频率范围	2400~2500MHZ 5180~5320MHZ 5700~5800MHZ	Frequency Range	2400~2500MHZ 5180~5320MHZ 5700~5800MHZ
电压驻波比	≤2.0	VSWR	≤2.0
增益	2~3DBI	GAIN	2~3DBI
输入阻抗	50 Ω	Input Impedance	50 Ω
机械指标		Mechanical Specifications	
天线颜色	黑色	Antenna Color	BLACK
接口形式	IPEX-1	Input connector	IPEX-1
线长度	50mm	Cable length	50mm
工作温度	-40℃~+85℃	Working Temperature	-40℃~+85℃
工作湿度	20~80%	Working Humidity	20~80%

Chart 1 TYY-TX2811 Product size

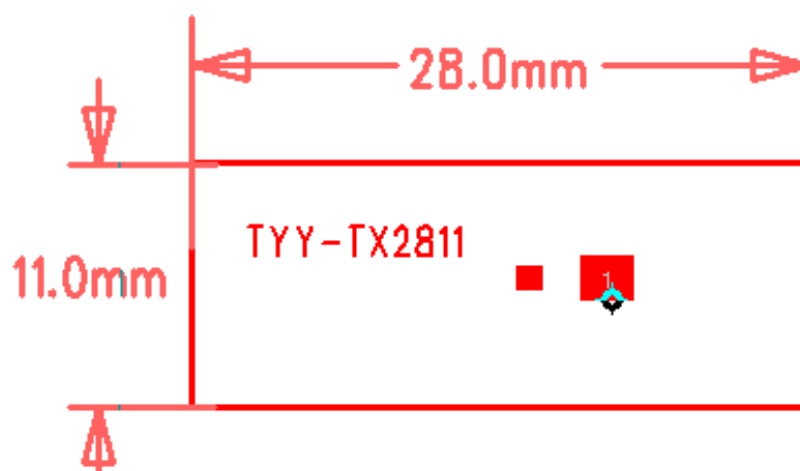
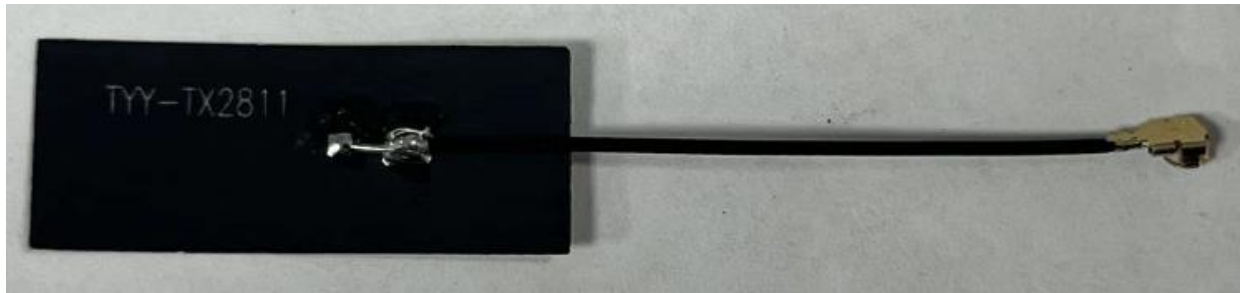

Chart 2 TYY-TX2811 Antenna finished



Line length 45+/-2mm, The other end with the 2-IPEX.

Chart 3 Location of antenna patch



Matters needing attention: WIFI antenna behind the tear tape on the back glue stick flat side, away from the screen on the back of the metal, away from the loudspeaker hardware, if the antenna near the metal lead to WIFI signal frequency deviation, make the antenna standing wave ratio and power and efficiency will become poor, and the signal will become worse, the frequency shift signal variation can also cause interference, so must be in accordance with our marking the location of the antenna, thank you!

2. Electrical properties

2.1 WIFI Antenna matching circuit

This item matching circuit is provided by the customer.

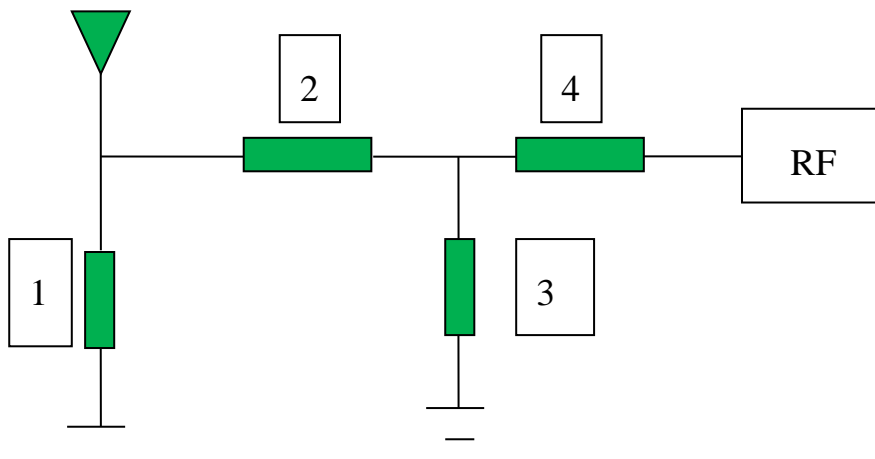

Element number	1	2	3	4
WIFI optimum	NC	0 ohm	NC	
Original (spare)	50 ohm matching (inductance capacitance / sunlord Darfon)			

Chart 4 OTA Microwave dark room

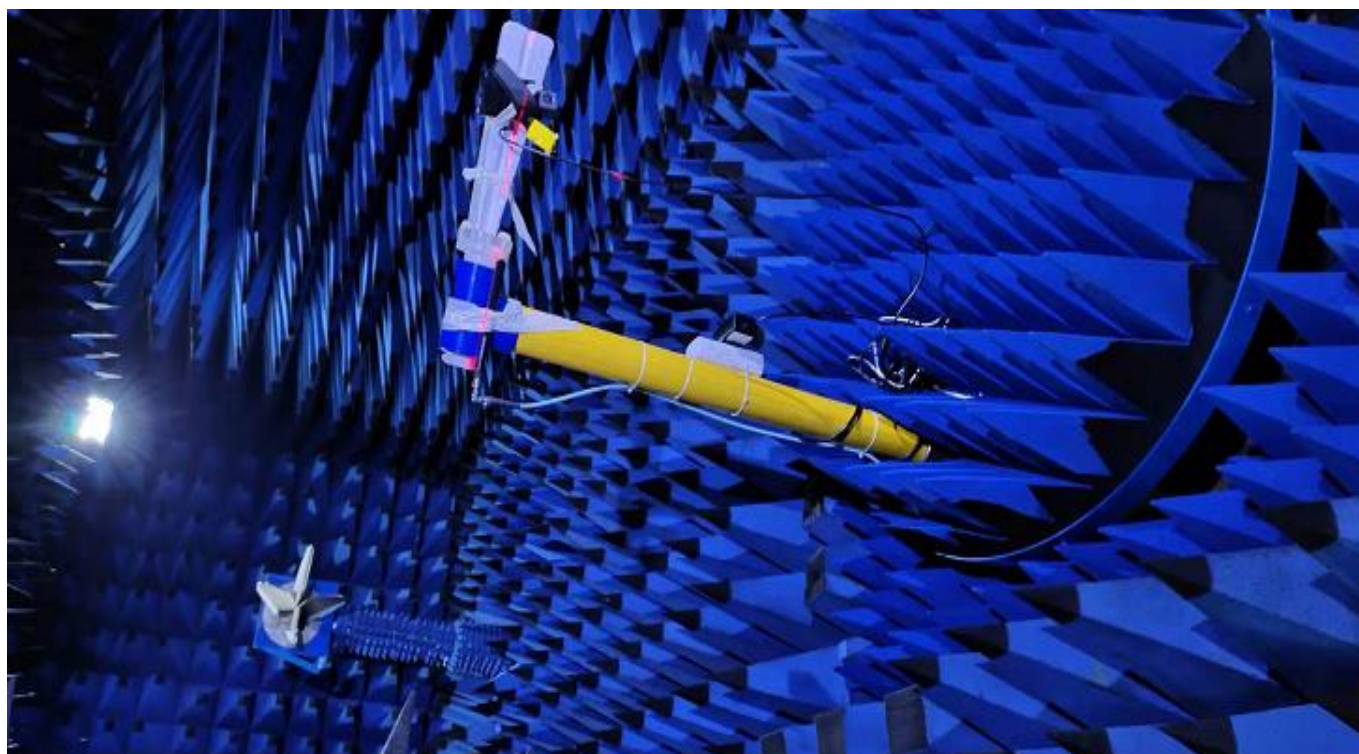

2.3 Bobbi (VSWR) test

2.3.1. Test setup

Connect the VSWR test device are: Agilent E5071B network analyzer from 50 ohm coaxial Cable 120mm long

Brass & test fixture

Processing test fixture: 50 ohm antenna leads to SMA-J connector from the test point on the plate PCB with a rigid cable, and a

Connect the choke tube, and then sequentially connected with other devices.

WIFI In Bobbi

Chart 5 Return loss

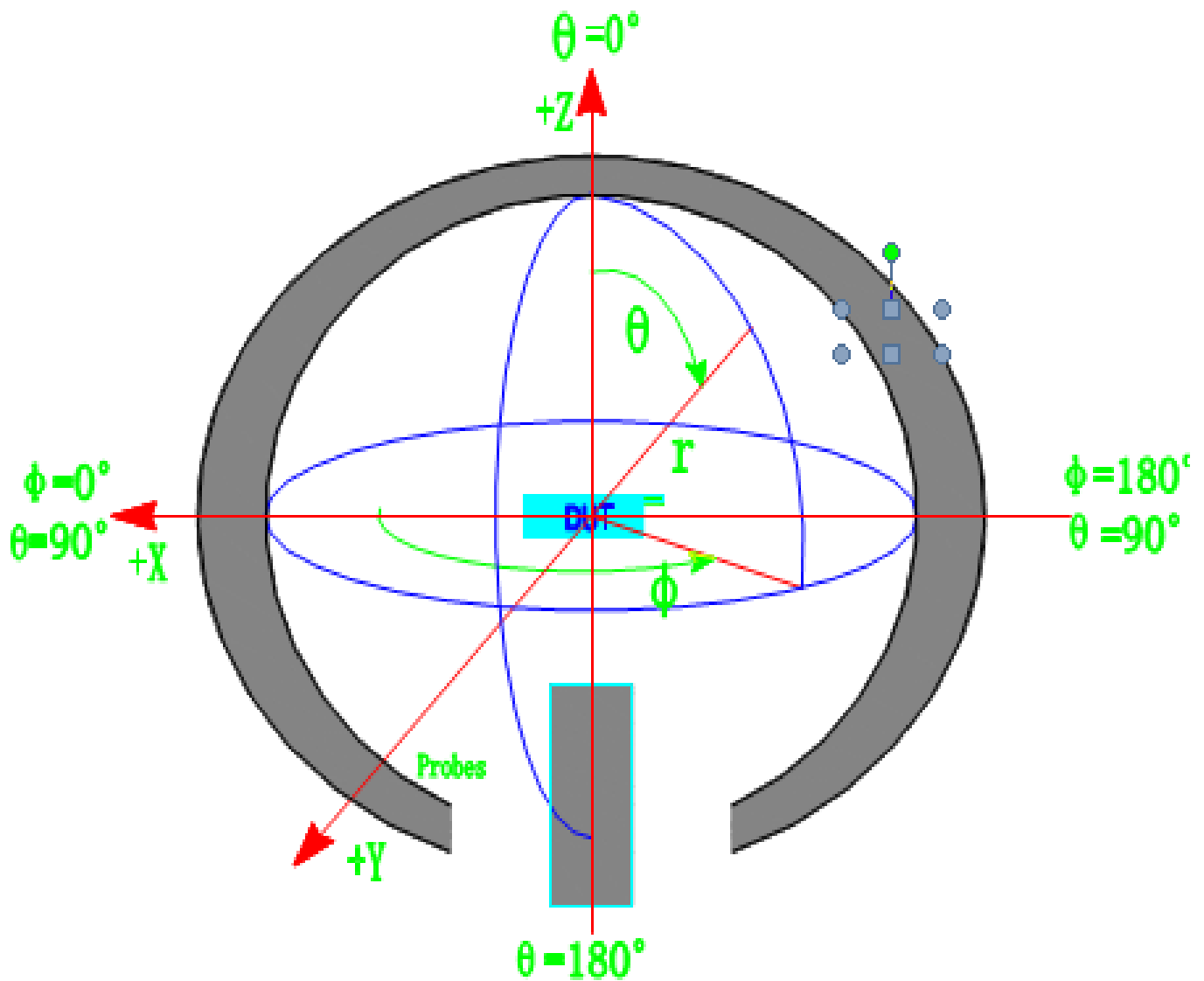

4. 3D dynamic test of the whole machine

4.1 Test site

TCT microwave anechoic chamber: the test frequency range is 800MHz-6GHz, the quiet zone range is 50cm circle, and the reflectivity is less than -90 dB.

Chart 6 Agilent E5071C network analyzer

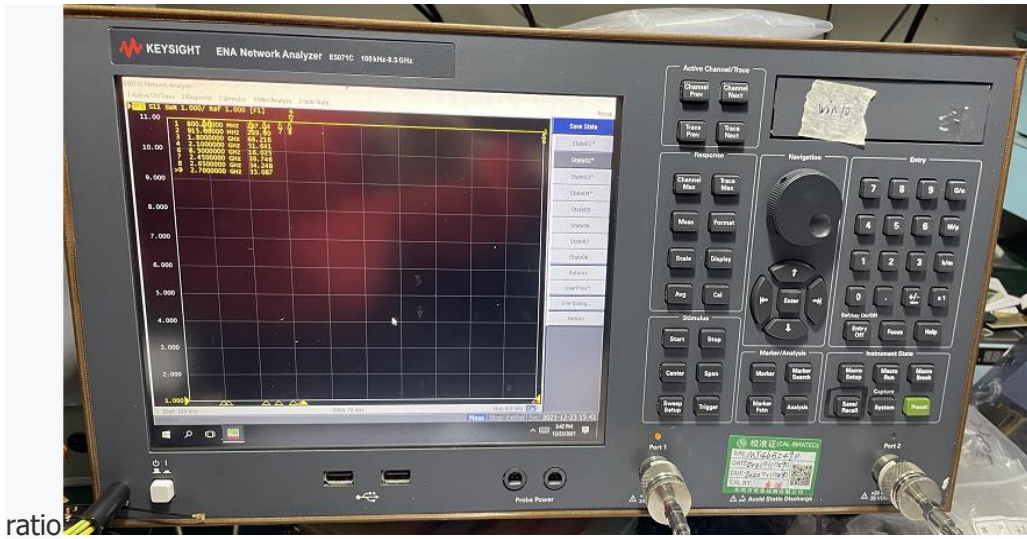

ratio

Chart 7 WIFI VSWR

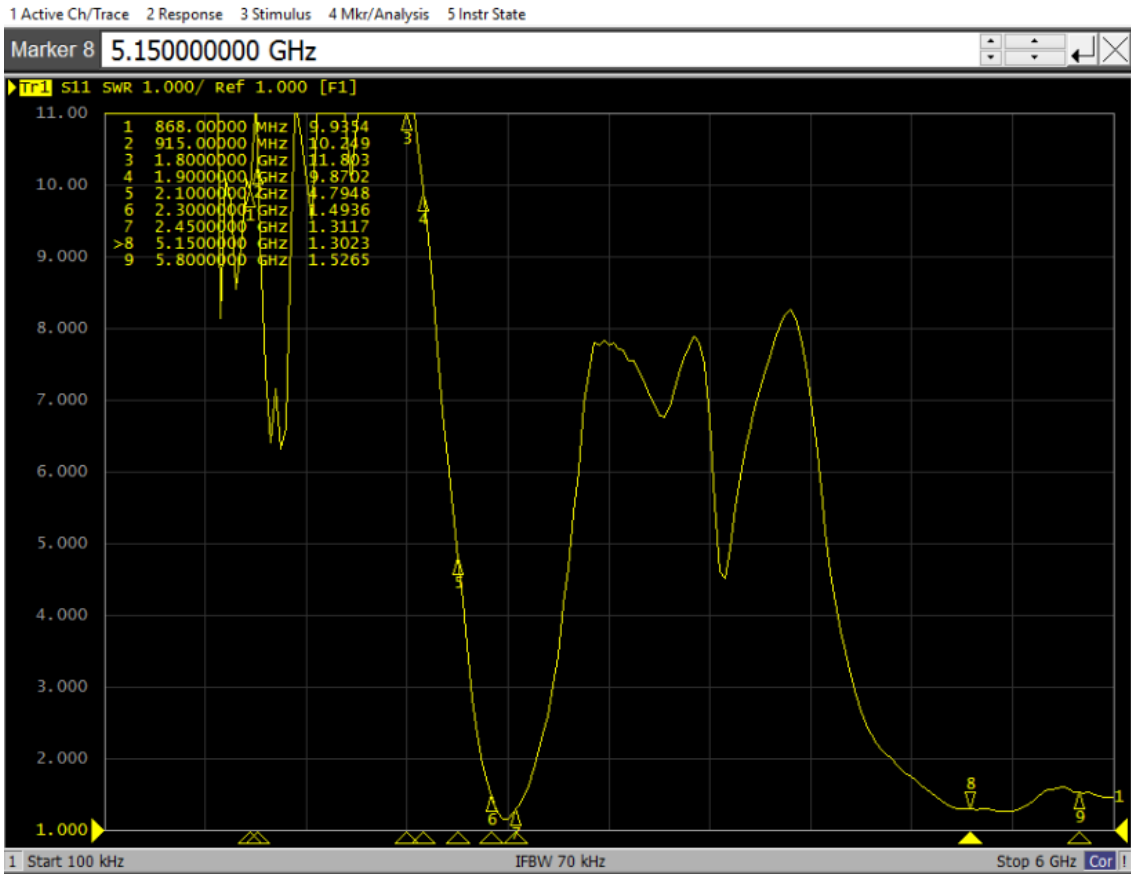

standard	Low frequency		High frequency	
frequency (MHz)	2400	2450	5150	5800
VSWR	1.3	1.3	1.3	1.5

Chart 8 Elevation map coverage

FETUKEJI

Frequency ID	1	3	4	7	8	9	10	12	12	13	14	15	16	22	22
Frequency (MHz)	2400.0	2420.0	2450.0	2460.0	2470.0	2480.0	2490.0	5180.0	5220.0	5230.0	5250.0	5350.0	5720.0	5745.0	5800.0
Efficiency (dBi)	-2.44	-2.50	-2.22	-1.59	-1.52	-1.47	-1.86	-1.49	-1.49	-1.54	-1.08	-2.03	-2.62	-1.55	-1.55
Gain (dBi)	2.22	2.61	3.19	3.80	3.39	2.91	2.31	2.39	2.39	2.22	2.13	2.71	2.22	2.82	2.83
Efficiency (%)	57.02	56.28	59.97	69.33	70.41	71.29	65.19	71.01	71.01	70.17	78.01	62.63	54.67	70.06	70.17
Directivity (dB)	4.66	5.11	5.41	5.39	4.92	4.38	4.17	4.88	4.88	4.76	5.21	4.74	4.85	4.37	4.57
Peak Gain Position (Theta)	144.00	141.00	144.00	124.00	144.00	144.00	144.00	80.00	80.00	139.00	127.00	86.00	79.00	81.00	82.00
Peak Gain Position (Phi)	180.00	180.00	180.00	210.00	180.00	180.00	180.00	90.00	90.00	60.00	90.00	270.00	90.00	90.00	91.00
Efficiency ThetaPol (%)	39.41	39.00	41.74	49.26	49.81	50.37	45.84	22.93	22.93	22.25	23.88	22.95	24.09	23.39	23.29
Efficiency PhiPol (%)	17.60	17.28	18.23	20.07	20.59	20.92	19.35	48.08	48.08	47.91	54.13	39.67	30.58	46.67	46.35
Upper Hem. Efficiency (%)	21.62	20.70	21.72	25.75	26.56	27.24	24.88	33.45	33.45	33.00	36.85	29.73	26.01	31.23	32.23
Lower Hem. Efficiency (%)	35.39	35.57	38.25	43.58	43.84	44.04	40.30	37.56	37.56	37.17	41.16	32.89	28.66	38.83	38.65

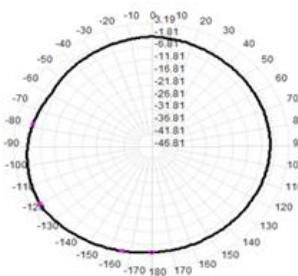
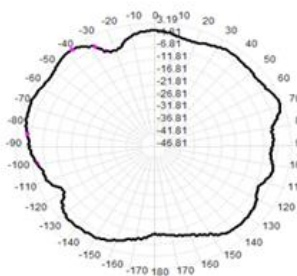
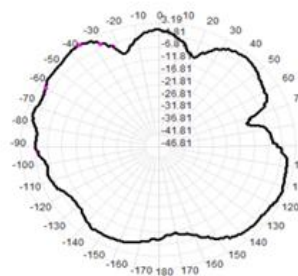
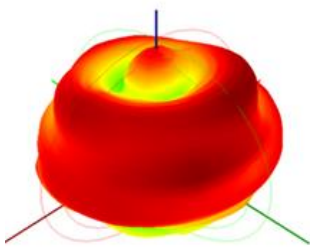
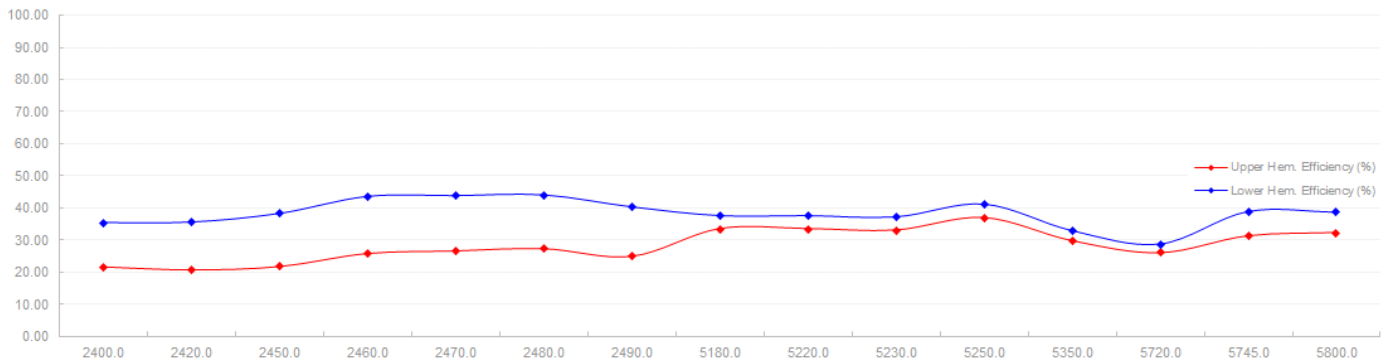
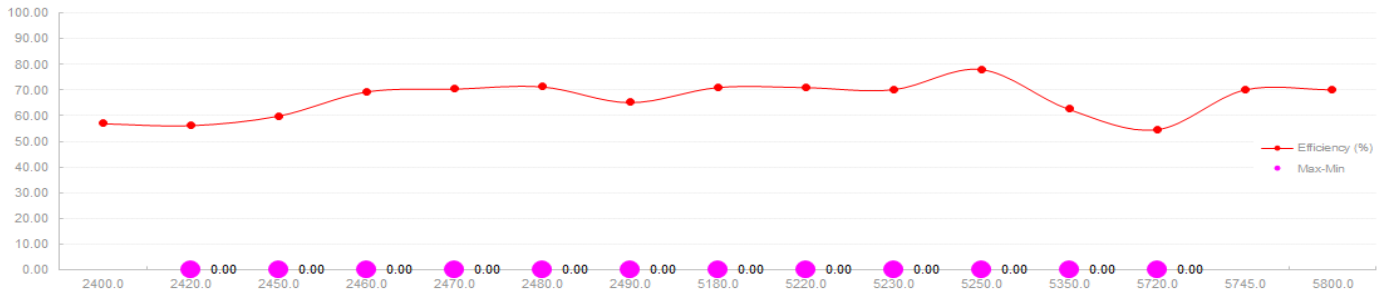
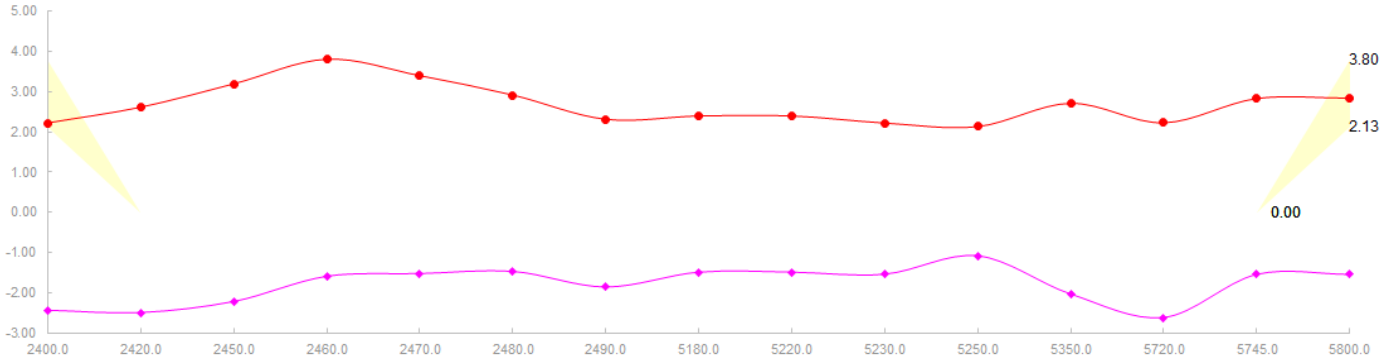

2400.0MHz H+V, Eff. 57.0%

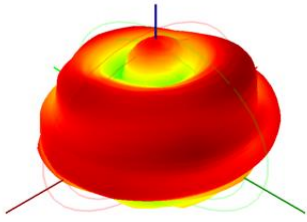

2400.0MHz Total(E1), Max= 2.22dBi

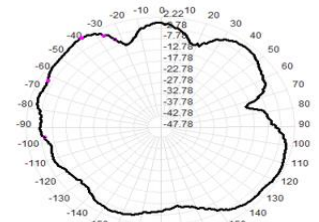

2400.0MHz Total(E2), Max= 1.02dBi

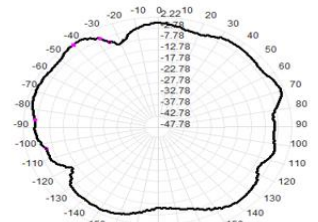

2400.0MHz Total(H), Max= -1.62dBi

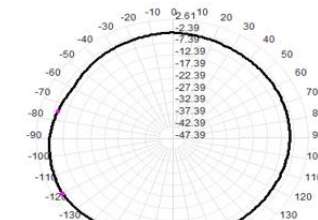
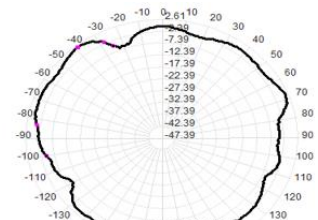
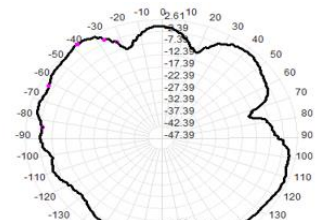
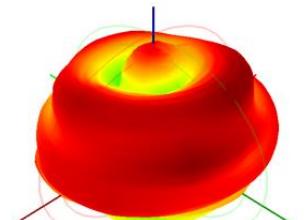
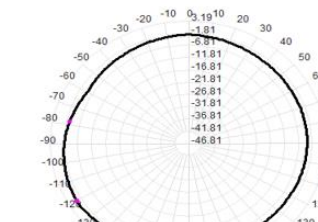
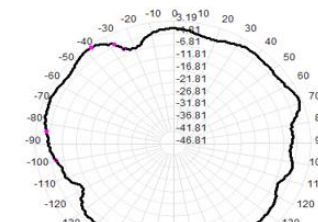
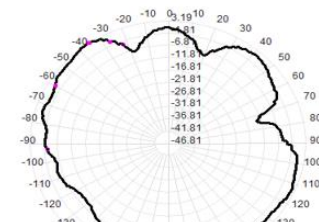
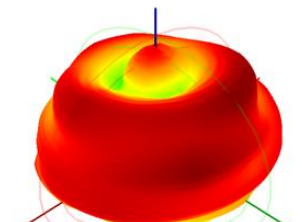
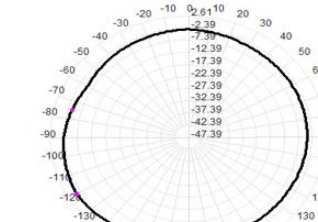
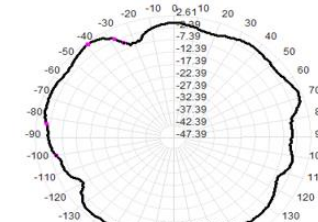
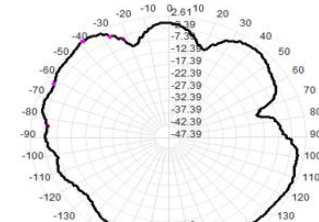
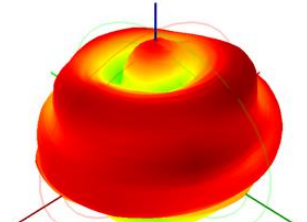
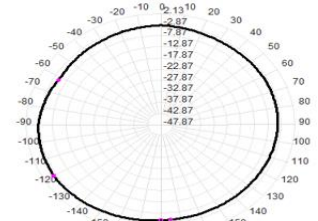
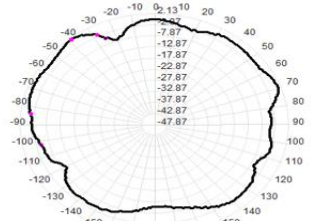
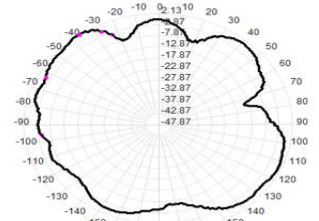
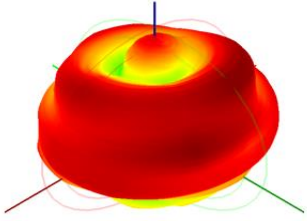
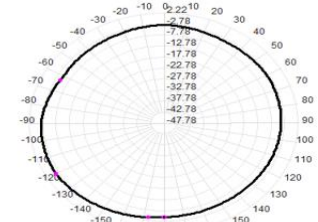

2470.0MHz H+V, Eff. 70.4%

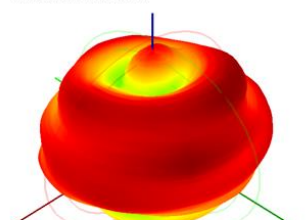

2470.0MHz Total(E1), Max= 3.39dBi

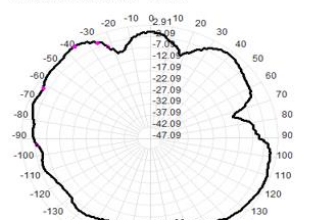

2470.0MHz Total(E2), Max= 2.29dBi

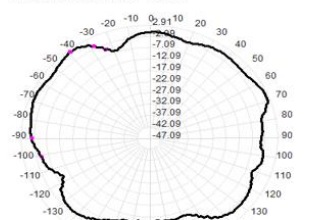

2470.0MHz Total(H), Max= 0.74dBi

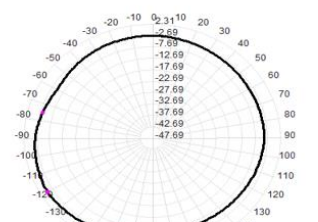
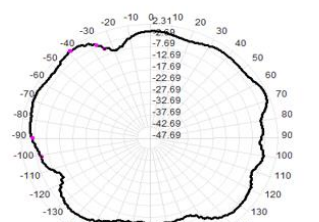
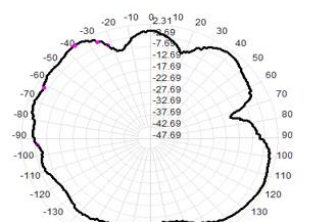
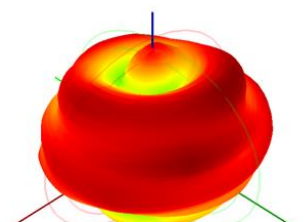
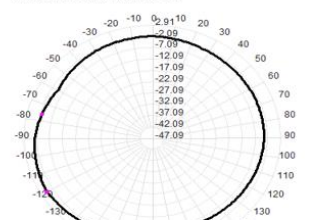

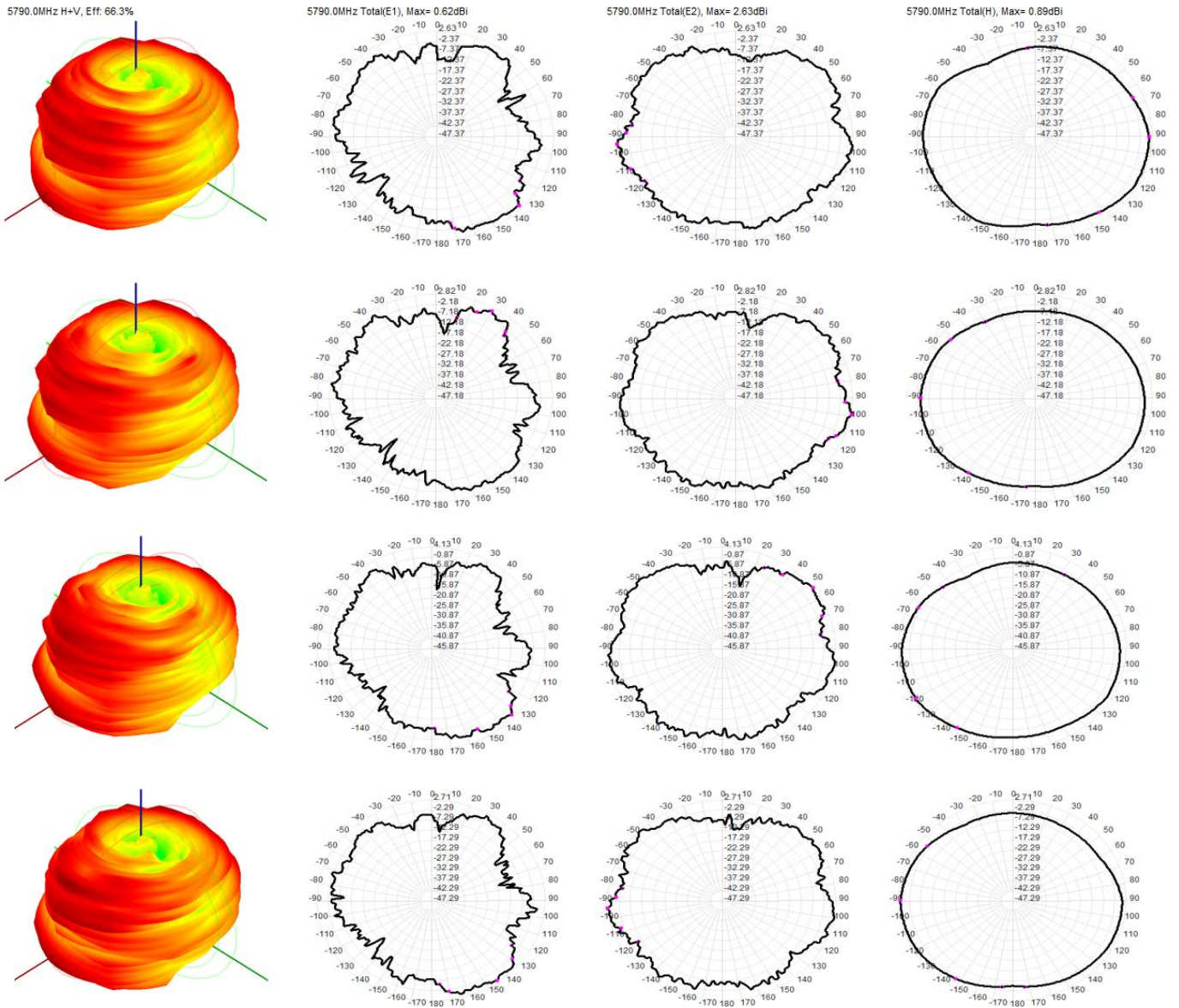

3, recommendations and conclusions

This report is based on the antenna electrical performance measured by the customer based on the final version of the model project of Hangzhou Rongmeng Intelligent Technology Co., LTD.

As can be seen from the above test data, the antenna provides good electrical performance.

Tianyiyuan is looking forward to your confirmation. Thank you for your cooperation!