



TEST REPORT

Applicant Name : Shenzhen Jiteng Network Technology Co., Ltd
Address : No.1202, Bitian Pavilion, Bizhong Garden, No.10 Bibo First Street,
Bibo Community, Huangbei Street, Luohu District, Shenzhen City,
China
Report Number : SZNS1211111-58026E-00B
FCC ID: 2AY4C-GM

Test Standard (s)
FCC PART 15.247

Sample Description

Product: Mini PC
Trademark: GEEKOM
Tested Model: GM08i5T
Multiple Model: GM08i5S, GMXXiXT, GMXXiXS, GMXXiXSS, GMXXiXTS,
(X substitutes 0, 1, 3, 5, 7, 8)
Date Received: 2021-11-11
Date of Test: 2021-11-16 to 2021-11-24
Report Date: 2021-12-13

Test Result:	Pass*
--------------	-------

* In the configuration tested, the EUT complied with the standards above.

Prepared and Checked By:

Fan Yang
EMC Engineer

Approved By:

Candy Li
EMC Engineer

Note: This report may contain data that are not covered by the A2LA accreditation and are marked with an asterisk "★".

Shenzhen Accurate Technology Co., Ltd. is not responsible for the authenticity of any test data provided by the applicant. Data included from the applicant that may affect test results are marked with an asterisk "**". Customer model name, addresses, names, trademarks etc. are not considered data.

This report cannot be reproduced except in full, without prior written approval of the Company. Unless otherwise stated the results shown in this test report refer only to the sample(s) tested. This report is valid only with a valid digital signature. The digital signature may be available only under the Adobe software above version 7.0.

Shenzhen Accurate Technology Co., Ltd.

1/F., Building A, Changyuan New Material Port, Science & Industry Park, Nanshan District, Shenzhen, Guangdong, P.R. China
Tel: +86 755-26503290 Fax: +86 755-26503396 Web: www.atc-lab.com

TABLE OF CONTENTS

GENERAL INFORMATION	4
PRODUCT DESCRIPTION FOR EQUIPMENT UNDER TEST (EUT).....	4
OBJECTIVE	4
TEST METHODOLOGY	4
MEASUREMENT UNCERTAINTY.....	5
SYSTEM TEST CONFIGURATION	6
DESCRIPTION OF TEST CONFIGURATION	6
EQUIPMENT MODIFICATIONS	6
EUT EXERCISE SOFTWARE	6
DUTY CYCLE	6
SUPPORT EQUIPMENT LIST AND DETAILS	7
EXTERNAL I/O CABLE.....	8
BLOCK DIAGRAM OF TEST SETUP	9
SUMMARY OF TEST RESULTS	11
TEST EQUIPMENT LIST	12
FCC §1.1310 & §2.1091 –MAXIMUM PERMISSIBLE EXPOSURE (MPE)	13
FCC §15.203 - ANTENNA REQUIREMENT	15
APPLICABLE STANDARD	15
ANTENNA CONNECTOR CONSTRUCTION	15
FCC §15.207 (a) – AC LINE CONDUCTED EMISSIONS	16
APPLICABLE STANDARD	16
EUT SETUP	16
EMI TEST RECEIVER SETUP.....	16
TEST PROCEDURE	16
TRANSD FACTOR & MARGIN CALCULATION.....	17
TEST DATA	17
FCC §15.209, §15.205 & §15.247(d) - SPURIOUS EMISSIONS	26
APPLICABLE STANDARD	26
EUT SETUP	26
EMI TEST RECEIVER & SPECTRUM ANALYZER SETUP	27
TEST PROCEDURE	27
FACTOR & MARGIN CALCULATION	27
TEST DATA	27
FCC §15.247(a) (2) – 6 dB EMISSION BANDWIDTH & OCCUPIED BANDWIDTH	36
APPLICABLE STANDARD	36
TEST PROCEDURE	36
TEST DATA	36
FCC §15.247(b) (3) - MAXIMUM CONDUCTED OUTPUT POWER	37
APPLICABLE STANDARD	37
TEST PROCEDURE	37
TEST DATA	37
FCC §15.247(d) – 100 kHz BANDWIDTH OF FREQUENCY BAND EDGE	38
APPLICABLE STANDARD	38

TEST PROCEDURE	38
TEST DATA	38
FCC §15.247(e) - POWER SPECTRAL DENSITY	39
APPLICABLE STANDARD	39
TEST PROCEDURE	39
TEST DATA	39
APPENDIX Wi-Fi.....	40
APPENDIX A: 6dB EMISSION BANDWIDTH.....	40
APPENDIX B: OCCUPIED CHANNEL BANDWIDTH	53
APPENDIX C: MAXIMUM CONDUCTED OUTPUT AVERAGE POWER	66
APPENDIX D: POWER SPECTRAL DENSITY	67
APPENDIX E: BAND EDGE MEASUREMENTS.....	80
APPENDIX F: DUTY CYCLE	88

GENERAL INFORMATION**Product Description for Equipment under Test (EUT)**

Product	Mini PC
Tested Model	GM08i5T
Multiple Model	GM08i5S, GMXXiXT, GMXXiXS, GMXXiXSS, GMXXiXTS, (X substitutes 0, 1, 3, 5, 7, 8)
Model Difference	Please refer to the DoS letter
Frequency Range	Wi-Fi: 2412-2462MHz
Maximum Conducted Peak Output Power	Wi-Fi: 19.10dBm(802.11b), 18.91dBm(802.11g), 18.95dBm(802.11n20), 19.01dBm(802.11n40)
Modulation Technique	Wi-Fi: DSSS, OFDM
Antenna Specification*	Internal Antenna: Ant 0: 1.89dBi(provided by the applicant) Ant 1: 2.68dBi(provided by the applicant)
Voltage Range	DC 19V from Adapter
Sample number	SZNS1211111-58026E-RF-S1 (Assigned by ATC)
Sample/EUT Status	Good condition
Adapter 1 information	Model: HKA09019047-6U Input: AC 100-240V, 50/60Hz, 1.5A Output: DC 19V, 4.74A
Adapter 2 information	Model: HKA06519034-6J Input: AC 100-240V, 50/60Hz, 1.5A Output: DC 19V, 3.42A
Adapter 3 information	Model: ADS-110CL-19-3 190090E Input: AC 100-240V, 50/60Hz, 1.5A Output: DC 19V, 4.74A
Adapter 4 information	Model: ADS-65HI-19A-3 19065E Input: AC 100-240V, 50/60Hz, 1.5A Output: DC 19V, 3.42A

Objective

This test report is in accordance with Part 2-Subpart J, Part 15-Subparts A and C of the Federal Communication Commission's rules.

The tests were performed in order to determine compliance with FCC Part 15, Subpart C, and section 15.203, 15.205, 15.207, 15.209 and 15.247 rules.

Test Methodology

All measurements contained in this report were conducted with ANSI C63.10-2013, American National Standard of Procedures for Compliance Testing of Unlicensed Wireless Devices.

And KDB 558074 D01 15.247 Meas Guidance v05r02.

All emissions measurement was performed at Shenzhen Accurate Technology Co., Ltd. The radiated testing was performed at an antenna-to-EUT distance of 3 meters.

Measurement Uncertainty

Parameter		Uncertainty
Occupied Channel Bandwidth		5%
RF output power, conducted		0.73dB
Unwanted Emission, conducted		1.6dB
AC Power Lines Conducted Emissions		2.72dB
Emissions, Radiated	30MHz - 1GHz	4.28dB
	1GHz - 18GHz	4.98dB
	18GHz - 26.5GHz	5.06dB
Temperature		1°C
Humidity		6%
Supply voltages		0.4%

Note: The extended uncertainty given in this report is obtained by combining the standard uncertainty times the coverage factor K with the 95% confidence interval. Otherwise required by the applicant or Product Regulations, Decision Rule in this report did not consider the uncertainty.

Test Facility

The test site used by Shenzhen Accurate Technology Co., Ltd. to collect test data is located on the 1/F., Building A, Changyuan New Material Port, Science & Industry Park, Nanshan District, Shenzhen, Guangdong, P.R. China.

The test site has been approved by the FCC under the KDB 974614 D01 and is listed in the FCC Public Access Link (PAL) database, FCC Registration No.: 708358, the FCC Designation No.: CN1189. Accredited by American Association for Laboratory Accreditation (A2LA) The Certificate Number is 429 7.01.

Listed by Innovation, Science and Economic Development Canada (ISED), the Registration Number is 5077A.

SYSTEM TEST CONFIGURATION

Description of Test Configuration

For 802.11b, 802.11g, 802.11n-HT20 and 802.11n-HT40 mode, total 11 channels are provided to testing:

Channel	Frequency (MHz)	Channel	Frequency (MHz)
1	2412	7	2442
2	2417	8	2447
3	2422	9	2452
4	2427	10	2457
5	2432	11	2462
6	2437	/	/

802.11b, 802.11g and 802.11n-HT20 mode was tested with Channel 1, 6 and 11.

802.11n-HT40 mode was tested with Channel 3, 6 and 9.

Equipment Modifications

No modification was made to the EUT tested.

EUT Exercise Software

“DRTU”* software was used to test and power level as below:

Ant 0:

Mode	Data rate	Power Level*		
		Low Channel	Middle Channel	High Channel
802.11b	1 Mbps	11	11	11
802.11g	6 Mbps	11	11	11
802.11n-HT20	MCS0	11	11	11
802.11n-HT40	MCS0	11	11	11

Ant 1:

Mode	Data rate	Power Level*		
		Low Channel	Middle Channel	High Channel
802.11b	1 Mbps	11	11	11
802.11g	6 Mbps	11	11	11
802.11n-HT20	MCS0	11	11	11
802.11n-HT40	MCS0	11	11	11

The worst-case data rates are determined to be as above for each mode based upon investigations by measuring the average power and PSD across all data rates, bandwidths and modulations. The device supports SISO and MIMO 2T2R in all modes. Per pretest, 2TX mode was the worst mode and recorded in this report.

Duty cycle

Test Result: Compliant. Please refer to the Appendix Wi-Fi.

Support Equipment List and Details

Manufacturer	Description	Model	Serial Number
DELL	Keyboard	KB216d1	Unknown
DELL	Mouse	MS116c	Unknown
PHILIPS	Monitor	275M7C	UK02141059255272
XIAOMI	TV	L43M5-ES	25131/114100057334
DELL	laptop	LatitudeE5570	6DCCRC2
Kingston	U-DISK	DTSE9 16GB	Unknown
SanDisk	SD Card	Ultra 32GB	Unknown
HUAWEI	Mobile Phone 1	HUAWEI Mate30	FEC0220506013544
XIAOMI	Mobile Phone 2	MI 10	957921bb
HUAWEI	Earphone	Unknown	Unknown

External I/O Cable

Cable Description	Length (m)	From Port	To
Unshielded Detachable AC output Cable	1.0	Adapter	LISN
Unshielded Detachable DC power Cable	1.5	EUT	Adapter 1
Unshielded Detachable DC power Cable	1.2	EUT	Adapter 2
Unshielded Detachable DC power Cable	1.2	EUT	Adapter 3
Unshielded Detachable DC power Cable	1.5	EUT	Adapter 4
Unshielded Detachable HDMI Cable	1.05	EUT	TV
Unshielded Detachable DP Cable	0.95	EUT	Monitor
Unshielded Detachable USB Cable	1.5	EUT	Mouse
Unshielded Detachable USB Cable	1.5	EUT	Keyboard
Unshielded Detachable RJ45 Cable	3	EUT	Notebook
Unshielded Detachable earphone Cable	0.75	EUT	Earphone
Unshielded Detachable USB Cable	1.15	EUT	Mobile phone1
Unshielded Detachable USB Cable	0.95	EUT	Mobile phone2

Block Diagram of Test Setup

For conducted emission:
AC Mains:

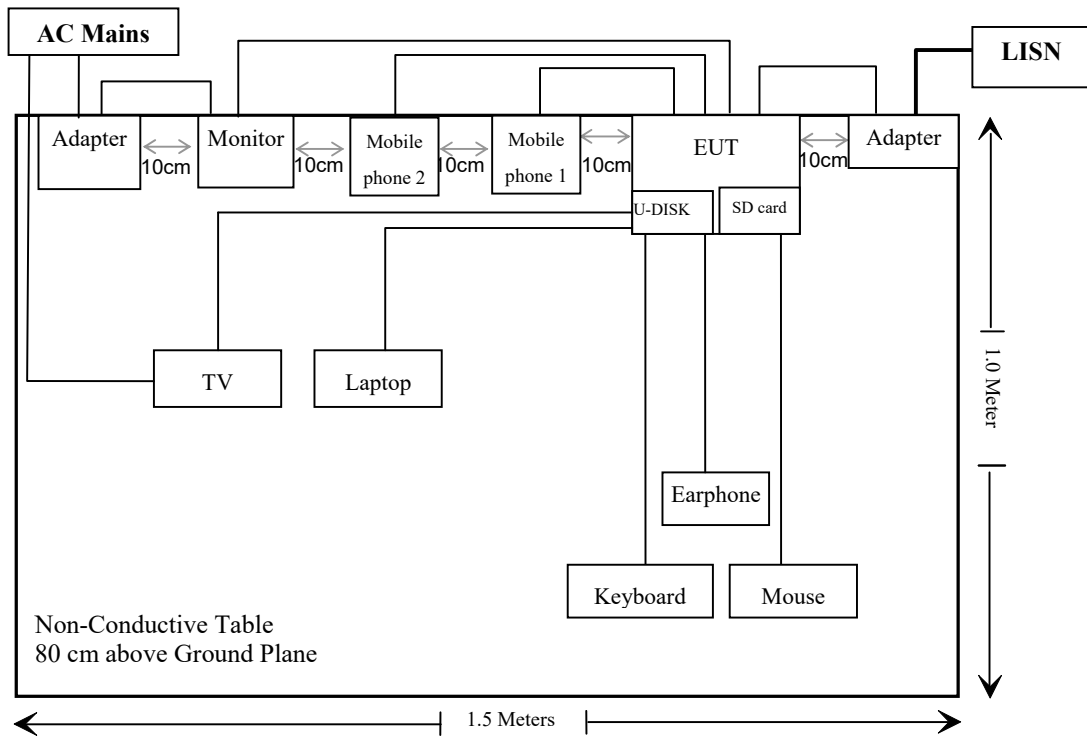

For Radiated emission:
Below 1GHz:

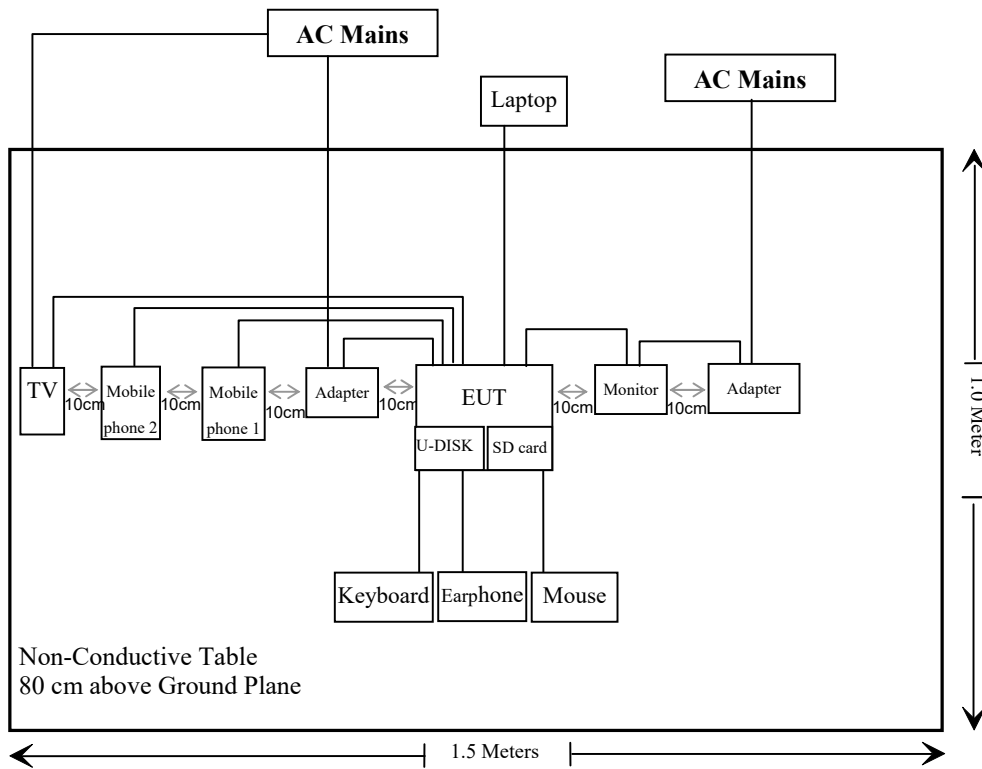

Above 1GHz:

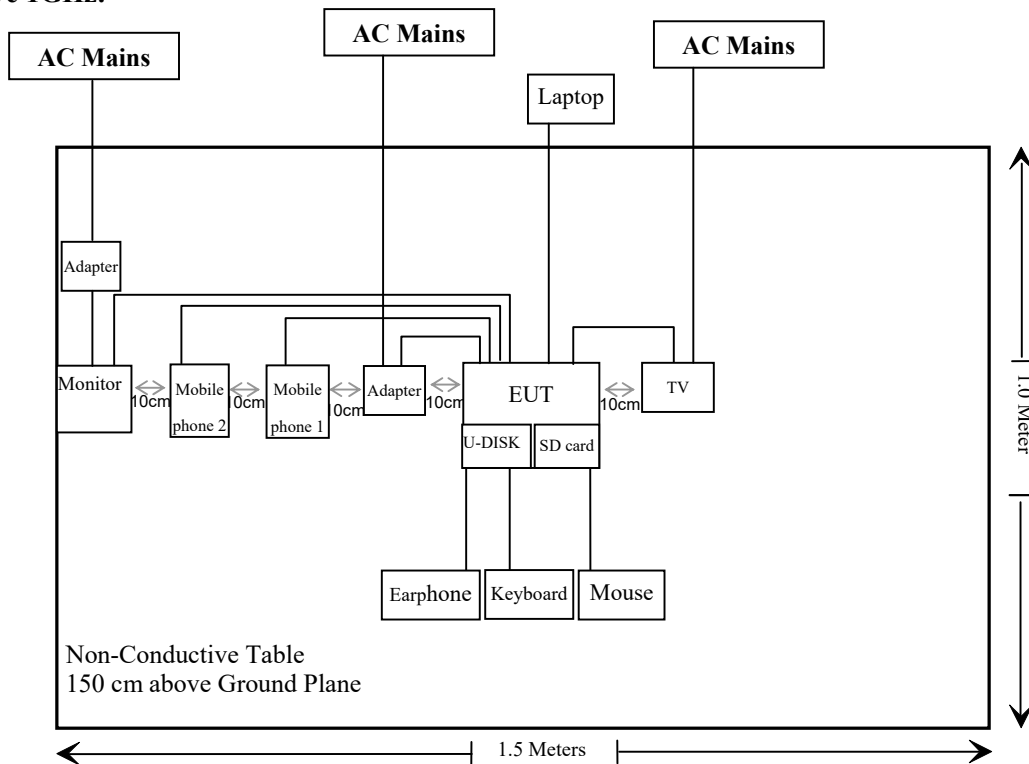

SUMMARY OF TEST RESULTS

FCC Rules	Description of Test	Result
§15.247 (I), §1.1310 & §2.1091	Maximum Permissible Exposure (MPE)	Compliant
§15.203	Antenna Requirement	Compliant
§15.207 (a)	AC Line Conducted Emissions	Compliant
§15.205, §15.209, §15.247(d)	Spurious Emissions	Compliant
§15.247 (a)(2)	6 dB Emission Bandwidth & Occupied Bandwidth	Compliant
§15.247(b)(3)	Maximum Conducted Output Power	Compliant
§15.247(d)	100 kHz Bandwidth of Frequency Band Edge	Compliant
§15.247(e)	Power Spectral Density	Compliant

Note: Per pre-test with models of GM08i5T and GM08i5S, and the worst case about maximum emission is model of GM08i5T, which was recorded in this report.

TEST EQUIPMENT LIST

Manufacturer	Description	Model	Serial Number	Calibration Date	Calibration Due Date
Conducted Emissions Test					
Rohde& Schwarz	EMI Test Receiver	ESCI	100784	2021/02/03	2022/02/02
R & S	L.I.S.N.	ENV216	101314	2020/12/25	2021/12/24
Anritsu Corp	50Ω Coaxial Switch	MP59B	6200506474	2020/12/25	2021/12/24
Unknown	RF Coaxial Cable	N-2m	No.2	2020/12/25	2021/12/24
Conducted Emission Test Software: e3 19821b(V9)					
Radiated Emissions Test					
Rohde& Schwarz	Test Receiver	ESR	102725	2020/12/25	2021/12/24
Rohde&Schwarz	Spectrum Analyzer	FSV40	101949	2021/5/18	2022/5/17
A.H. Systems, inc.	Preamplifier	PAM-0118P	531	2021/11/9	2022/11/8
Quinstar	Amplifier	QLW-184055 36-J0	15964001002	2020/11/28	2021/11/27
SONOMA INSTRUMENT	Amplifier	310 N	186131	2020/12/25	2021/12/24
Anritsu Corp	50 Coaxial Switch	MP59B	6100237248	2020/12/25	2021/12/24
Schwarzbeck	Bilog Antenna	VULB9163	9163-323	2020/01/05	2023/01/04
Schwarzbeck	Horn Antenna	BBHA9120D	9120D-1067	2020/01/05	2023/01/04
Schwarzbeck	HORN ANTENNA	BBHA9170	9170-359	2020/01/05	2023/01/04
Unknown	RF Coaxial Cable	N-5m	No.3	2020/12/25	2021/12/24
Unknown	RF Coaxial Cable	N-1m	No.5	2020/12/25	2021/12/24
Unknown	RF Coaxial Cable	N-10m	No.7	2021/11/09	2022/11/08
Unknown	RF Coaxial Cable	N-2m	No.8	2021/11/09	2022/11/08
Wainwright	High Pass Filter	WHKX3.6/18 G-10SS	5	2020/12/25	2021/12/24
Radiated Emission Test Software: e3 19821b(V9)					
RF Conducted Test					
Rohde&Schwarz	Spectrum Analyzer	FSV40	101949	2021/5/18	2022/5/17
Rohde & Schwarz	Open Switch and Control Unit	OSP120 +OSP -B157	101244 + 100866	2020/12/24	2021/12/23

* **Statement of Traceability:** Shenzhen Accurate Technology Co., Ltd. attests that all calibrations have been performed in accordance to requirements that traceable to National Primary Standards and International System of Units (SI).

FCC §1.1310 & §2.1091 –MAXIMUM PERMISSIBLE EXPOSURE (MPE)

Applicable Standard

According to subpart §2.1091 and subpart §1.1310, systems operating under the provisions of this section shall be operated in a manner that ensures that the public is not exposed to radio frequency energy level in excess of the Commission's guidelines.

Limits for Maximum Permissible Exposure (MPE) (§1.1310, §2.1091)

(B) Limits for General Population/Uncontrolled Exposure				
Frequency Range (MHz)	Electric Field Strength (V/m)	Magnetic Field Strength (A/m)	Power Density (mW/cm²)	Averaging Time (minutes)
0.3-1.34	614	1.63	*(100)	30
1.34-30	824/f	2.19/f	*(180/f ²)	30
30-300	27.5	0.073	0.2	30
300-1500	/	/	f/1500	30
1500-100,000	/	/	1.0	30

f = frequency in MHz; * = Plane-wave equivalent power density;

According to §1.1310 and §2.1091 RF exposure is calculated.

Calculated Formulary:

Predication of MPE limit at a given distance

$S = PG/4\pi R^2$ = power density (in appropriate units, e.g. mW/cm²);

P = power input to the antenna (in appropriate units, e.g., mW);

G = power gain of the antenna in the direction of interest relative to an isotropic radiator, the power gain factor, is normally numeric gain;

R = distance to the center of radiation of the antenna (appropriate units, e.g., cm);

Calculated Data:

For simultaneously transmit system, the calculated power density should comply with:

$$\sum_i \frac{S_i}{S_{Limit,i}} \leq 1$$

For worst case:

Mode	Frequency Range (MHz)	Antenna Gain		Tune-up Output Power		Evaluation Distance (cm)	Power Density (mW/cm ²)	MPE Limit (mW/cm ²)
		(dBi)	(numeric)	(dBm)	(mW)			
BT	2402-2480	1.89	1.55	7.00	5.01	20	0.0015	1.0
2.4G Wi-Fi	2412-2462	2.68	1.85	19.50	89.13	20	0.0329	1.0
5G Wi-Fi Band 1	5150-5250	3.47	2.22	17.00	50.12	20	0.0222	1.0
5G Wi-Fi Band 4	5725-5850	4.31	2.70	17.00	50.12	20	0.0269	1.0

Note: 1. The BT function can transmit at the same time with the Wi-Fi function.
2. The 2.4G Wi-Fi function can transmit at the same time with the 5G Wi-Fi function.

Simultaneous transmitting consideration:

The ratio= $MPE_{BT}/limit + MPE_{2.4G\ Wi-Fi}/limit + MPE_{5G\ Wi-Fi}/limit = 0.0015/1 + 0.0329/1 + 0.0269/1 = 0.0613 < 1.0$

To maintain compliance with the FCC's RF exposure guidelines, place the equipment at least 20cm from nearby persons.

Result: Compliant.

FCC §15.203 - ANTENNA REQUIREMENT

Applicable Standard

According to § 15.203, an intentional radiator shall be designed to ensure that no antenna other than that furnished by the responsible party shall be used with the device. The use of a permanently attached antenna or of an antenna that uses a unique coupling to the intentional radiator shall be considered sufficient to comply with the provisions of this section. The manufacturer may design the unit so that a broken antenna can be replaced by the user, but the user of a standard antenna jack or electrical connector is prohibited. The structure and application of the EUT were analyzed to determine compliance with section §15.203 of the rules. §15.203 state that the subject device must meet the following criteria:

- a. Antenna must be permanently attached to the unit.
- b. Antenna must use a unique type of connector to attach to the EUT.

Unit must be professionally installed, and installer shall be responsible for verifying that the correct antenna is employed with the unit.

And according to FCC 47 CFR section 15.247 (b), if the transmitting antennas of directional gain greater than 6dBi are used, the power shall be reduced by the amount in dB that the directional gain of the antenna exceeds 6 dBi.

Antenna Connector Construction

The EUT has two internal antennas used arrangement for Wi-Fi, which was permanently attached and the antenna gain is 1.89dBi (Ant0) and 2.68dBi (Ant1), fulfill the requirement of this section. Please refer to the EUT photos.

Result: Compliant.

FCC §15.207 (a) – AC LINE CONDUCTED EMISSIONS**Applicable Standard**

FCC§15.207

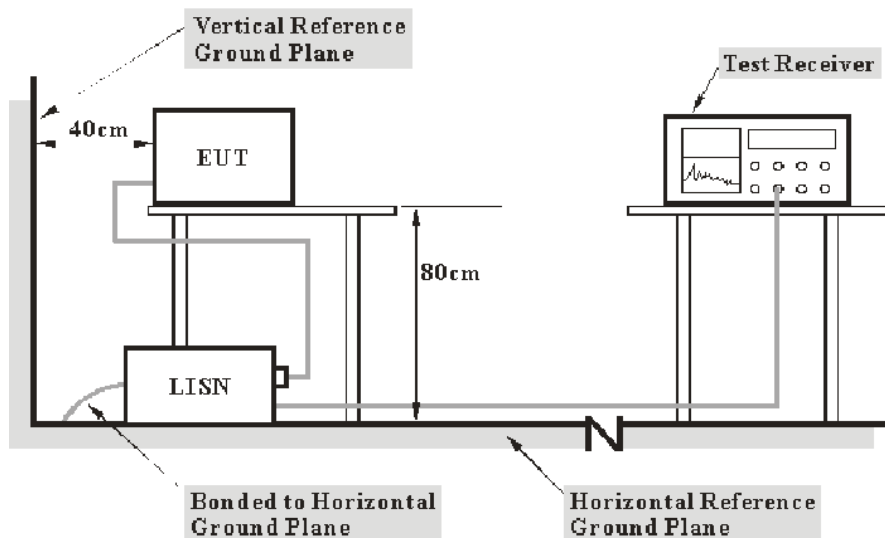
EUT Setup

- Note: 1. Support units were connected to second LISN.
 2. Both of LISNs (AMN) 80 cm from EUT and at the least 80 cm from other units and other metal planes support units.

The setup of EUT is according with per ANSI C63.10-2013 measurement procedure. The specification used was with the FCC Part 15.207 limits.

The spacing between the peripherals was 10 cm.

EMI Test Receiver Setup

The EMI test receiver was set to investigate the spectrum from 150 kHz to 30 MHz.

During the conducted emission test, the EMI test receiver was set with the following configurations:

Frequency Range	IF B/W
150 kHz – 30 MHz	9 kHz

Test Procedure

During the conducted emission test, the adapter was connected to the outlet of the LISN.

Maximizing procedure was performed on the six (6) highest emissions of the EUT.

All final data was recorded in the Quasi-peak and average detection mode.

Transd Factor & Margin Calculation

The Transd factor is calculated by adding LISN VDF (Voltage Division Factor) and Cable Loss. The basic equation is as follows:

$$\text{Transd Factor} = \text{LISN VDF} + \text{Cable Loss}$$

The “**Over limit**” column of the following data tables indicates the degree of compliance with the applicable limit. For example, an Over limit of -7 dB means the emission is 7 dB below the limit. The equation for calculation is as follows:

$$\begin{aligned} \text{Over Limit} &= \text{Level} - \text{Limit} \\ \text{Level} &= \text{Read Level} + \text{Factor} \end{aligned}$$

Test Data**Environmental Conditions**

Temperature:	25 °C
Relative Humidity:	64 %
ATM Pressure:	101.0 kPa

The testing was performed by Bin Duan on 2021-11-23.

EUT operation mode: 2.4G Wi-Fi Transmitting (Worst case as below)

Adapter 1:
AC 120V/60 Hz, Line

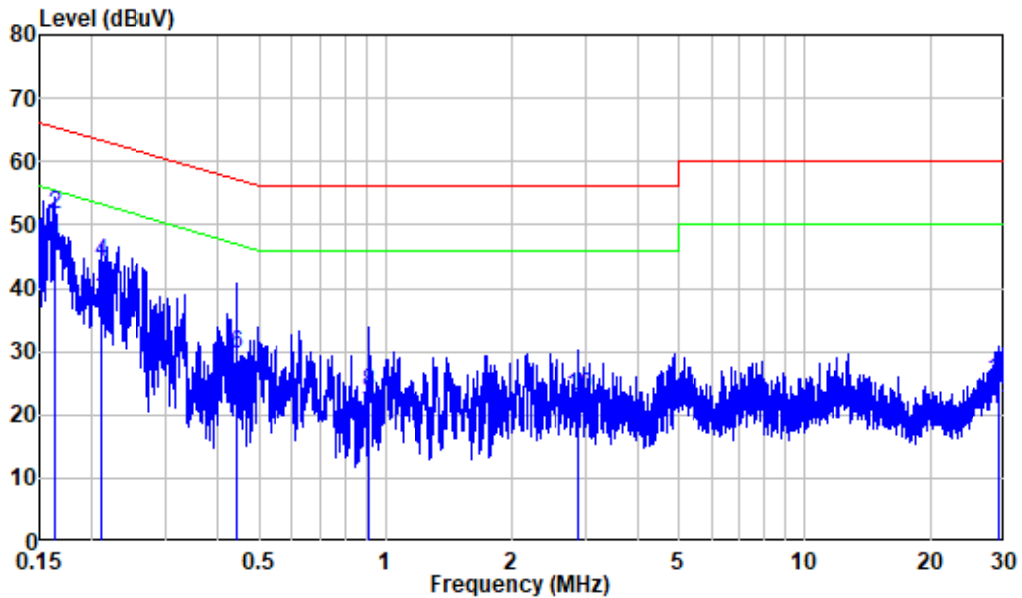

Site : Shielding Room
 Condition: Line
 Mode : 2.4G WIFI Transmitting

	Freq	Factor	Read Level	Level	Limit Line	Over Limit	Remark
	MHz	dB	dBuV	dBuV	dBuV	dB	
1	0.163	9.87	36.46	46.33	55.28	-8.95	Average
2	0.163	9.87	41.70	51.57	65.28	-13.71	QP
3	0.210	9.80	28.09	37.89	53.22	-15.33	Average
4	0.210	9.80	34.16	43.96	63.22	-19.26	QP
5	0.442	9.80	10.78	20.58	47.02	-26.44	Average
6	0.442	9.80	19.87	29.67	57.02	-27.35	QP
7	0.915	9.81	10.13	19.94	46.00	-26.06	Average
8	0.915	9.81	13.64	23.45	56.00	-32.55	QP
9	2.898	9.93	10.70	20.63	46.00	-25.37	Average
10	2.898	9.93	12.96	22.89	56.00	-33.11	QP
11	29.216	10.48	10.47	20.95	50.00	-29.05	Average
12	29.216	10.48	14.91	25.39	60.00	-34.61	QP

AC 120V/60 Hz, Neutral

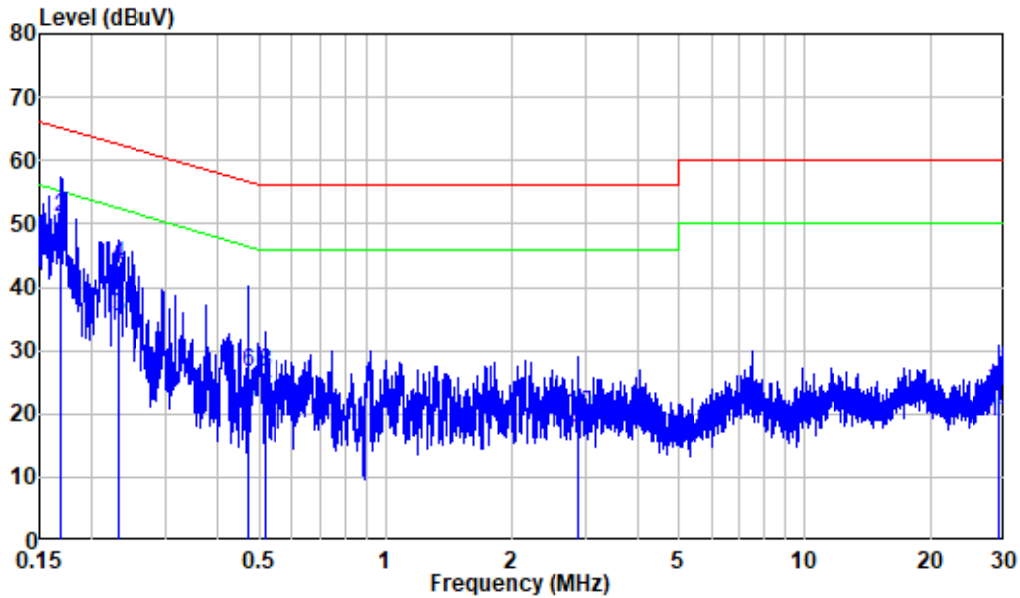

Site : Shielding Room
 Condition: Neutral
 Mode : 2.4G WIFI Transmitting

	Freq	Factor	Read Level	Limit Level	Limit Line	Over Limit	Remark
	MHz	dB	dBuV	dBuV	dBuV	dB	
1	0.169	9.94	36.40	46.34	55.00	-8.66	Average
2	0.169	9.94	40.94	50.88	65.00	-14.12	QP
3	0.230	9.98	25.46	35.44	52.45	-17.01	Average
4	0.230	9.98	33.52	43.50	62.45	-18.95	QP
5	0.469	9.91	11.55	21.46	46.53	-25.07	Average
6	0.469	9.91	16.76	26.67	56.53	-29.86	QP
7	0.520	9.91	12.48	22.39	46.00	-23.61	Average
8	0.520	9.91	16.73	26.64	56.00	-29.36	QP
9	2.892	9.98	7.59	17.57	46.00	-28.43	Average
10	2.892	9.98	9.88	19.86	56.00	-36.14	QP
11	29.081	10.38	8.37	18.75	50.00	-31.25	Average
12	29.081	10.38	13.57	23.95	60.00	-36.05	QP

**Adapter 2:
AC 120V/60 Hz, Line**

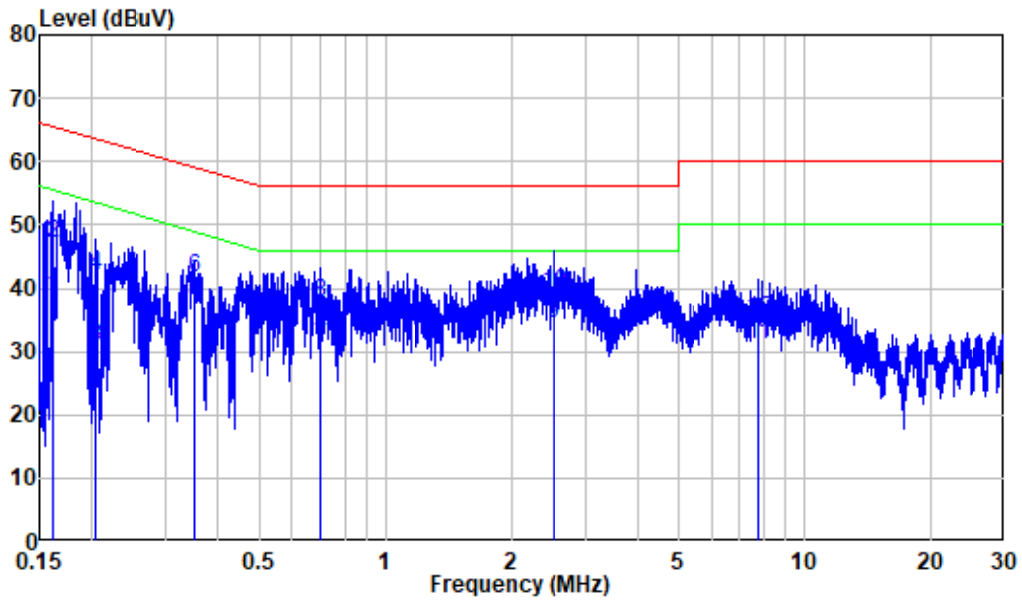

Site : Shielding Room
 Condition: Line
 Mode : 2.4G WIFI Transmitting

	Freq	Factor	Read Level	Level	Limit Line	Over Limit	Remark
	MHz	dB	dBuV	dBuV	dBuV	dB	
1	0.161	9.88	28.78	38.66	55.43	-16.77	Average
2	0.161	9.88	37.12	47.00	65.43	-18.43	QP
3	0.203	9.80	21.13	30.93	53.48	-22.55	Average
4	0.203	9.80	32.27	42.07	63.48	-21.41	QP
5	0.350	9.80	28.16	37.96	48.95	-10.99	Average
6	0.350	9.80	31.85	41.65	58.95	-17.30	QP
7	0.701	9.81	20.98	30.79	46.00	-15.21	Average
8	0.701	9.81	27.88	37.69	56.00	-18.31	QP
9	2.512	9.93	24.40	34.33	46.00	-11.67	Average
10	2.512	9.93	29.28	39.21	56.00	-16.79	QP
11	7.718	10.08	20.94	31.02	50.00	-18.98	Average
12	7.718	10.08	24.80	34.88	60.00	-25.12	QP

AC 120V/60 Hz, Neutral

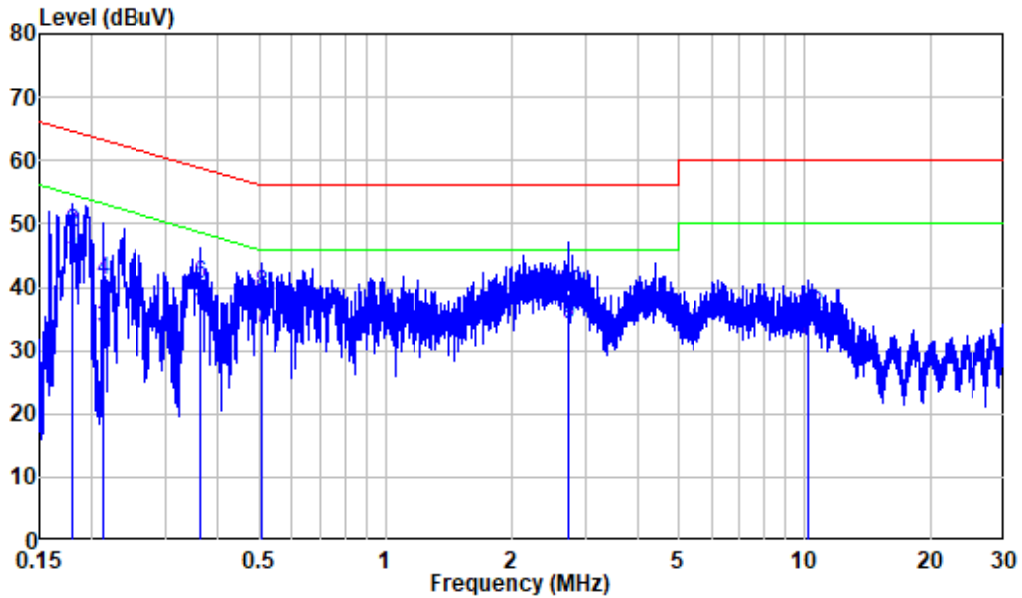

Site : Shielding Room
 Condition: Neutral
 Mode : 2.4G WIFI Transmitting

	Freq	Factor	Read Level	Level	Limit Line	Over Limit	Remark
	MHz	dB	dBuV	dBuV	dBuV	dB	
1	0.180	9.96	34.24	44.20	54.48	-10.28	Average
2	0.180	9.96	38.49	48.45	64.48	-16.03	QP
3	0.211	9.99	23.43	33.42	53.15	-19.73	Average
4	0.211	9.99	31.14	41.13	63.15	-22.02	QP
5	0.361	9.94	27.37	37.31	48.71	-11.40	Average
6	0.361	9.94	30.56	40.50	58.71	-18.21	QP
7	0.507	9.90	23.50	33.40	46.00	-12.60	Average
8	0.507	9.90	29.00	38.90	56.00	-17.10	QP
9	2.736	9.98	24.13	34.11	46.00	-11.89	Average
10	2.736	9.98	29.05	39.03	56.00	-16.97	QP
11	10.152	10.10	21.57	31.67	50.00	-18.33	Average
12	10.152	10.10	25.46	35.56	60.00	-24.44	QP

Adapter 3:
AC 120V/60 Hz, Line

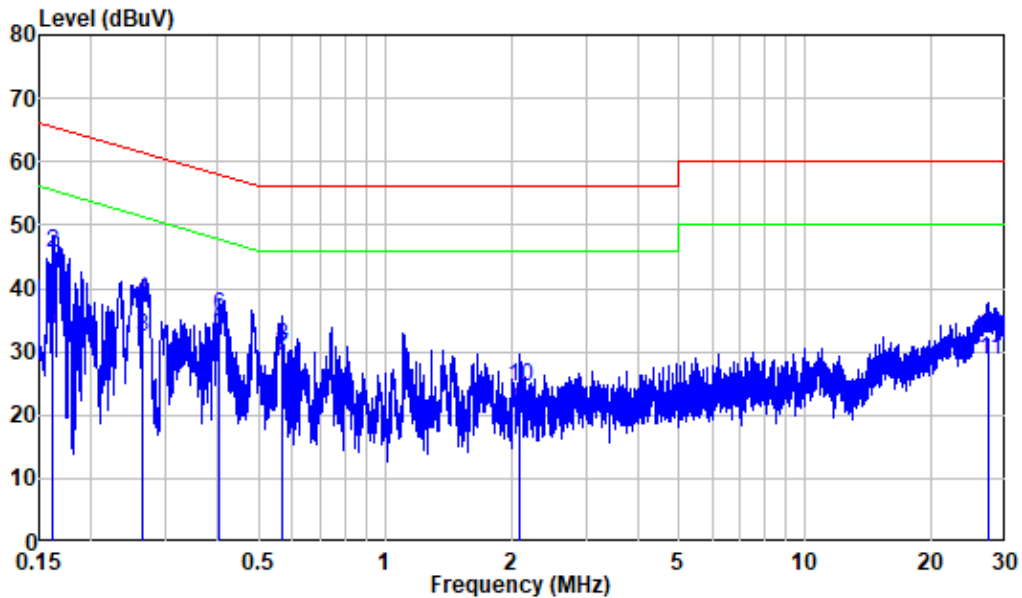

Site : Shielding Room
 Condition: Line
 Mode : 2.4G WIFI Transmitting

	Freq	Factor	Read Level	Level	Limit Line	Over Limit	Remark
	MHz	dB	dBuV	dBuV	dBuV	dB	
1	0.162	9.87	23.78	33.65	55.35	-21.70	Average
2	0.162	9.87	35.75	45.62	65.35	-19.73	QP
3	0.263	9.80	22.36	32.16	51.33	-19.17	Average
4	0.263	9.80	28.32	38.12	61.33	-23.21	QP
5	0.403	9.80	23.41	33.21	47.80	-14.59	Average
6	0.403	9.80	25.95	35.75	57.80	-22.05	QP
7	0.568	9.81	19.47	29.28	46.00	-16.72	Average
8	0.568	9.81	21.02	30.83	56.00	-25.17	QP
9	2.081	9.92	11.02	20.94	46.00	-25.06	Average
10	2.081	9.92	14.63	24.55	56.00	-31.45	QP
11	27.362	10.42	18.19	28.61	50.00	-21.39	Average
12	27.362	10.42	21.89	32.31	60.00	-27.69	QP

AC 120V/60 Hz, Neutral

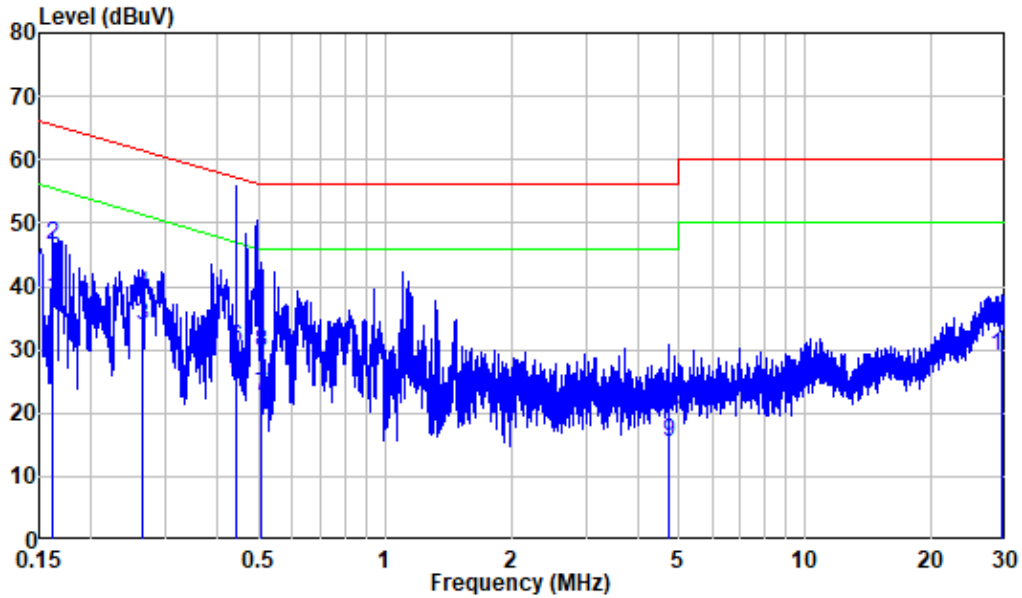

Site : Shielding Room
 Condition: Neutral
 Mode : 2.4G WIFI Transmitting

	Freq	Factor	Read Level	Level	Limit	Over	Remark
	MHz	dB	dBuV	dBuV	dBuV	dB	
1	0.162	9.93	28.21	38.14	55.37	-17.23	Average
2	0.162	9.93	36.67	46.60	65.37	-18.77	QP
3	0.265	9.97	23.94	33.91	51.29	-17.38	Average
4	0.265	9.97	28.56	38.53	61.29	-22.76	QP
5	0.441	9.91	15.93	25.84	47.05	-21.21	Average
6	0.441	9.91	20.37	30.28	57.05	-26.77	QP
7	0.506	9.90	12.62	22.52	46.00	-23.48	Average
8	0.506	9.90	19.58	29.48	56.00	-26.52	QP
9	4.734	10.05	5.32	15.37	46.00	-30.63	Average
10	4.734	10.05	10.62	20.67	56.00	-35.33	QP
11	29.293	10.38	18.54	28.92	50.00	-21.08	Average
12	29.293	10.38	22.84	33.22	60.00	-26.78	QP

Adapter 4:
AC 120V/60 Hz, Line

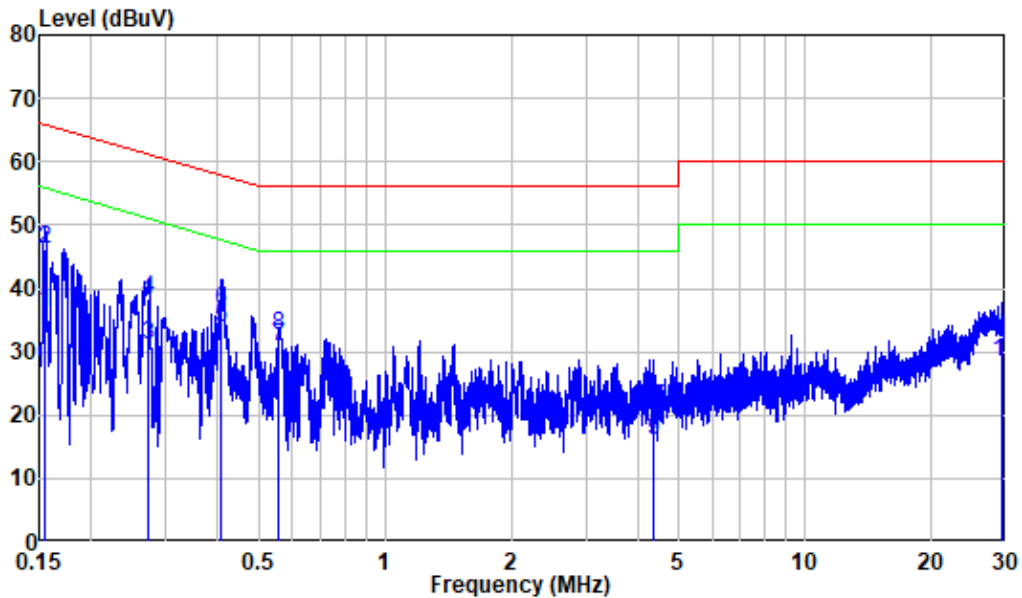

Site : Shielding Room
 Condition: Line
 Mode : 2.4G WIFI Transmitting

	Freq	Factor	Read Level	Level	Limit Line	Over Limit	Remark
	MHz	dB	dBuV	dBuV	dBuV	dB	
1	0.155	9.89	26.37	36.26	55.73	-19.47	Average
2	0.155	9.89	36.33	46.22	65.73	-19.51	QP
3	0.274	9.80	21.33	31.13	50.99	-19.86	Average
4	0.274	9.80	28.47	38.27	60.99	-22.72	QP
5	0.405	9.80	23.97	33.77	47.74	-13.97	Average
6	0.405	9.80	26.59	36.39	57.74	-21.35	QP
7	0.557	9.81	21.01	30.82	46.00	-15.18	Average
8	0.557	9.81	22.70	32.51	56.00	-23.49	QP
9	4.338	9.95	6.13	16.08	46.00	-29.92	Average
10	4.338	9.95	11.28	21.23	56.00	-34.77	QP
11	29.488	10.48	17.90	28.38	50.00	-21.62	Average
12	29.488	10.48	21.75	32.23	60.00	-27.77	QP

AC 120V/60 Hz, Neutral

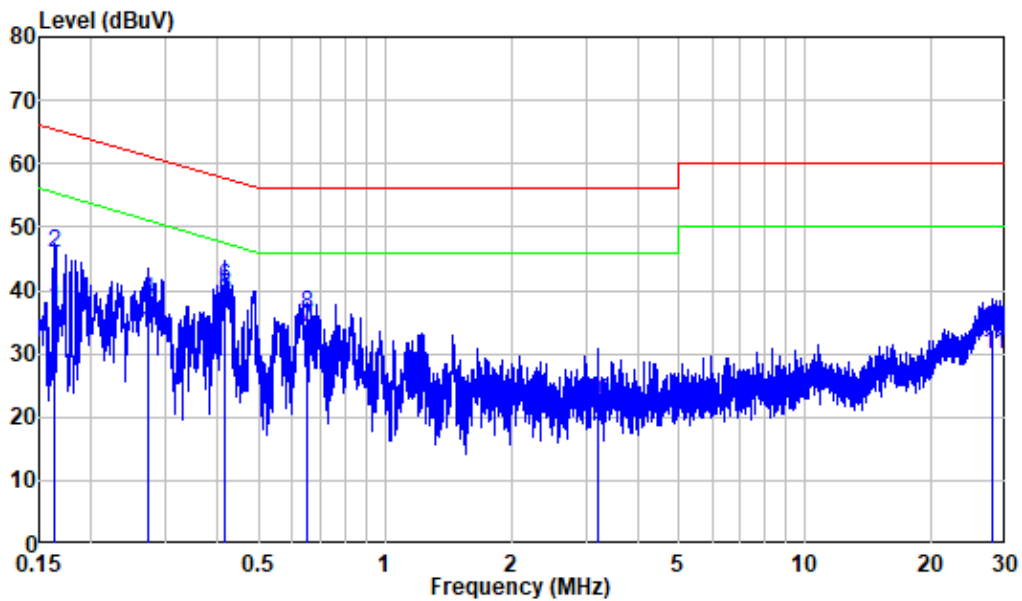

Site : Shielding Room
 Condition: Neutral
 Mode : 2.4G WIFI Transmitting

	Freq	Factor	Read Level	Level	Limit Line	Over Limit	Remark
	MHz	dB	dBuV	dBuV	dBuV	dB	
1	0.163	9.93	27.16	37.09	55.28	-18.19	Average
2	0.163	9.93	35.86	45.79	65.28	-19.49	QP
3	0.273	9.97	25.14	35.11	51.02	-15.91	Average
4	0.273	9.97	28.47	38.44	61.02	-22.58	QP
5	0.416	9.92	28.88	38.80	47.53	-8.73	Average
6	0.416	9.92	30.49	40.41	57.53	-17.12	QP
7	0.651	9.91	24.27	34.18	46.00	-11.82	Average
8	0.651	9.91	26.21	36.12	56.00	-19.88	QP
9	3.196	10.00	8.60	18.60	46.00	-27.40	Average
10	3.196	10.00	12.45	22.45	56.00	-33.55	QP
11	27.966	10.36	19.41	29.77	50.00	-20.23	Average
12	27.966	10.36	23.49	33.85	60.00	-26.15	QP

FCC §15.209, §15.205 & §15.247(d) - SPURIOUS EMISSIONS

Applicable Standard

FCC §15.247 (d); §15.209; §15.205;

EUT Setup

Below 1 GHz:

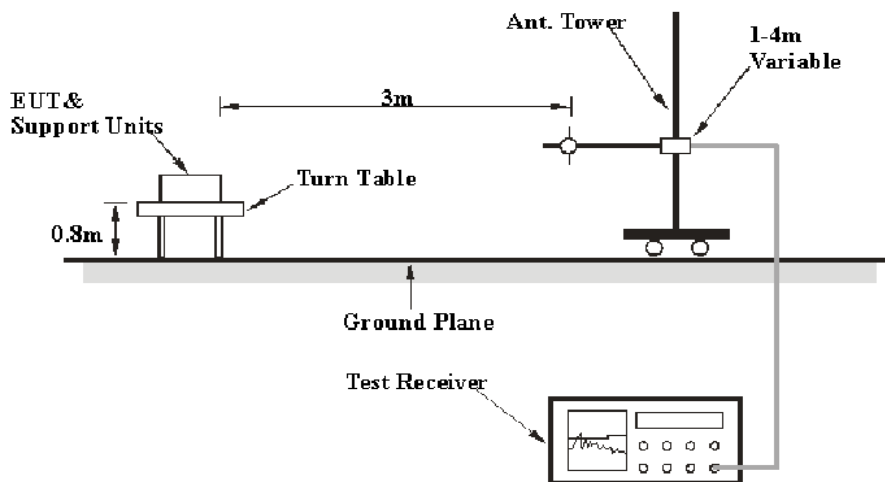

Above 1GHz:

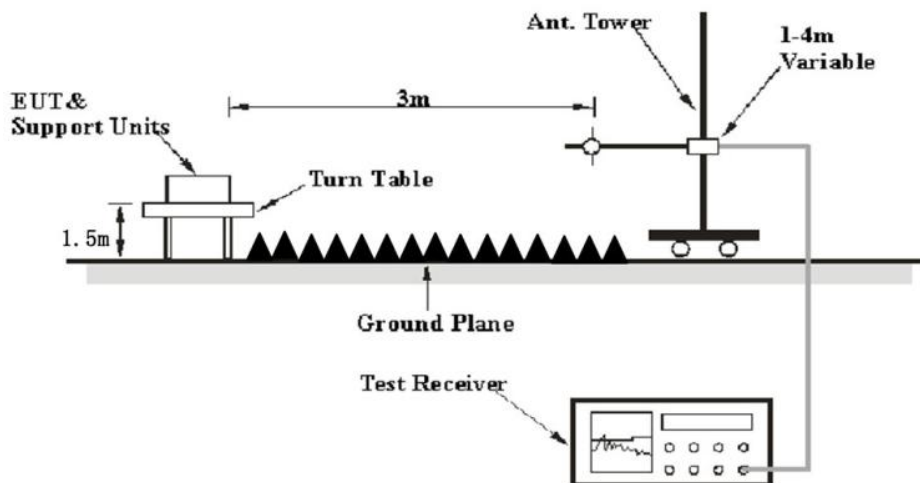

The radiated emission tests were performed in the 3 meters test site, using the setup accordance with the ANSI C63.10-2013. The specification used was the FCC 15.209, and FCC 15.247 limits.

EMI Test Receiver & Spectrum Analyzer Setup

During the radiated emission test, the EMI test receiver & Spectrum Analyzer Setup were set with the following configurations:

Frequency Range	RBW	Video B/W	IF B/W	Measurement
30 MHz – 1000 MHz	100 kHz	300 kHz	120 kHz	QP
Above 1 GHz	1MHz	3 MHz	/	PK
	1MHz	10 Hz ^{Note 1}	/	Average
	1MHz	> 1/T ^{Note 2}	/	Average

Note 1: when duty cycle is no less than 98%

Note 2: when duty cycle is less than 98%

Test Procedure

Maximizing procedure was performed on the highest emissions to ensure that the EUT complied with all installation combinations.

Data was recorded in Quasi-peak detection mode for frequency range of 30 MHz-1 GHz, peak and Average detection modes for frequencies above 1 GHz.

Factor & Margin Calculation

The Factor is calculated by adding the Antenna Factor and Cable Loss, and subtracting the Amplifier Gain. The basic equation is as follows:

$$\text{Factor} = \text{Antenna Factor} + \text{Cable Loss} - \text{Amplifier Gain}$$

The “**Over Limit/Margin**” column of the following data tables indicates the degree of compliance with the applicable limit. For example, an Over Limit/margin of -7dB means the emission is 7dB below the limit. The equation for calculation is as follows:

$$\begin{aligned} \text{Over Limit/Margin} &= \text{Level} / \text{Corrected Amplitude} - \text{Limit} \\ \text{Level} / \text{Corrected Amplitude} &= \text{Read Level} + \text{Factor} \end{aligned}$$

Test Data

Environmental Conditions

Temperature:	25 °C
Relative Humidity:	50-64 %
ATM Pressure:	101.0-103.0 kPa

The testing was performed by Chao Mo on 2021-11-16 for below 1GHz and 2021-11-20 for above 1GHz.

EUT operation mode: Transmitting

(Scan with 802.11b, 802.11g, 802.11n-HT20 and 802.11n-HT40 modes, the worst case as below)

**30MHz-1GHz: (Worst case for 802.11 N20, middle channel)
Adapter 1:**

Horizontal:

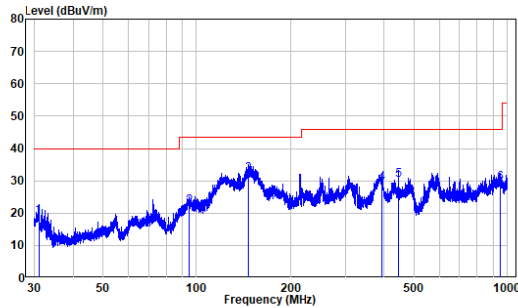

Site : chamber
 Condition: 3m HORIZONTAL
 Job No. : SZNS1211111-58026E-RF
 Test Mode: 2.4G WIFI Transmitting

	Freq	Factor	Read Level	Limit Level	Over Limit	Remark
	MHz	dB/m	dBuV	dBuV/m	dBuV/m	dB
1	31.06	-20.32	39.47	19.15	40.00	-20.85 QP
2	94.51	-20.30	42.41	22.11	43.50	-21.39 QP
3	146.63	-21.71	53.59	31.88	43.50	-11.62 QP
4	393.30	-15.78	44.93	29.15	46.00	-16.85 QP
5	445.05	-14.30	44.50	30.20	46.00	-15.80 QP
6	950.43	-8.05	37.20	29.15	46.00	-16.85 QP

Vertical

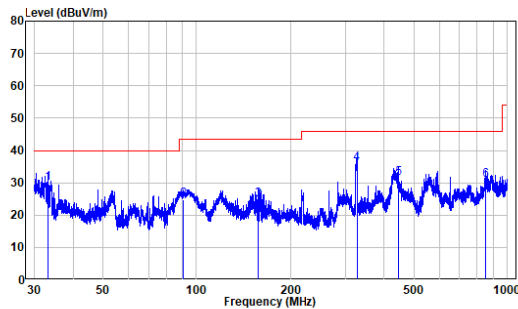

Site : chamber
 Condition: 3m VERTICAL
 Job No. : SZNS1211111-58026E-RF
 Test Mode: 2.4G WIFI Transmitting

	Freq	Factor	Read Level	Limit Level	Over Limit	Remark
	MHz	dB/m	dBuV	dBuV/m	dBuV/m	dB
1	33.23	-19.84	49.85	30.01	40.00	-9.99 QP
2	90.74	-21.10	45.92	24.82	43.50	-18.68 QP
3	157.08	-21.72	46.60	24.88	43.50	-18.62 QP
4	327.03	-16.73	52.80	36.07	46.00	-9.93 QP
5	445.05	-14.30	45.82	31.52	46.00	-14.48 QP
6	854.40	-9.46	40.35	30.89	46.00	-15.11 QP

Adapter 2:

Horizontal:

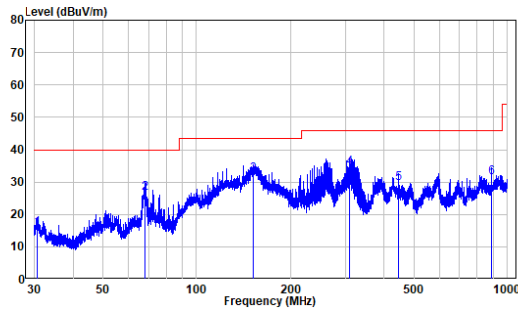

Site : chamber
 Condition: 3m HORIZONTAL
 Job No. : SZNS1211111-58026E-RF
 Test Mode: 2.4G WIFI Transmitting

	Freq	Factor	Read		Limit	Over	Remark
			Level	Level			
	MHz	dB/m	dBuV	dBuV/m	dBuV/m	dB	
1	30.77	-20.38	35.95	15.57	40.00	-24.43	QP
2	67.97	-20.94	47.63	26.69	40.00	-13.31	QP
3	151.33	-21.61	53.85	32.24	43.50	-11.26	QP
4	309.32	-16.66	50.95	34.29	46.00	-11.71	QP
5	445.05	-14.30	43.90	29.60	46.00	-16.40	QP
6	890.34	-8.52	39.80	31.28	46.00	-14.72	QP

Vertical

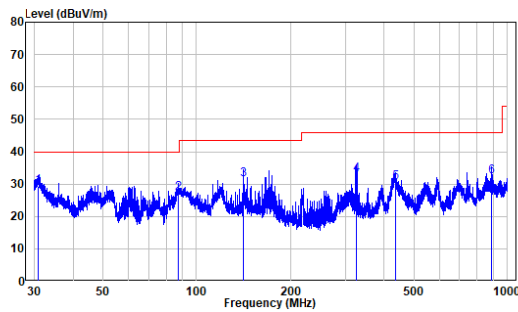

Site : chamber
 Condition: 3m VERTICAL
 Job No. : SZNS1211111-58026E-RF
 Test Mode: 2.4G WIFI Transmitting

	Freq	Factor	Read		Limit	Over	Remark
			Level	Level			
	MHz	dB/m	dBuV	dBuV/m	dBuV/m	dB	
1	30.92	-20.35	49.77	29.42	40.00	-10.58	QP
2	87.34	-21.78	48.91	27.13	40.00	-12.87	QP
3	141.33	-21.90	53.25	31.35	43.50	-12.15	QP
4	325.74	-16.74	49.69	32.95	46.00	-13.05	QP
5	435.59	-14.34	44.92	30.58	46.00	-15.42	QP
6	890.34	-8.52	40.69	32.17	46.00	-13.83	QP

Adapter 3:

Horizontal:

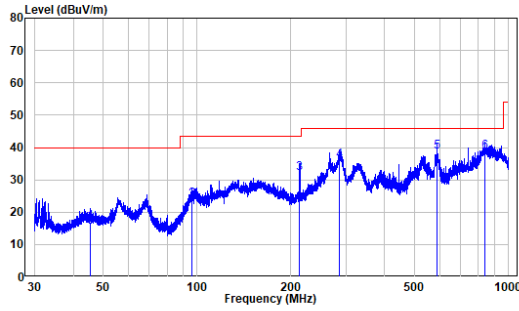

Site : chamber
 Condition: 3m HORIZONTAL
 Job No. : SZNS1211111-58026E-RF
 Test Mode: 2.4G WIFI Transmitting

	Freq	Factor	Read Level	Level	Limit	Over	Remark
	MHz	dB/m	dBuV	dBuV/m	dBuV/m	dB	
1	45.28	-9.95	26.97	17.02	40.00	-22.98	QP
2	95.97	-12.31	36.18	23.87	43.50	-19.63	QP
3	212.83	-11.75	43.76	32.01	43.50	-11.49	QP
4	285.48	-9.43	45.48	36.05	46.00	-9.95	QP
5	589.42	-2.77	41.37	38.60	46.00	-7.40	QP
6	840.65	0.28	38.47	38.75	46.00	-7.25	QP

Vertical

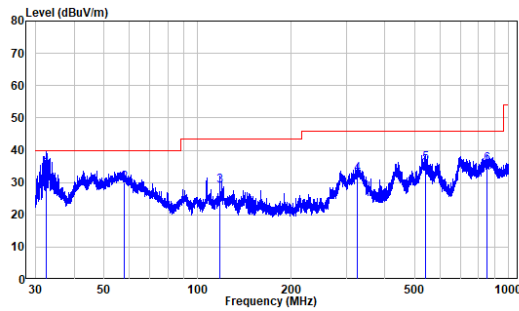

Site : chamber
 Condition: 3m VERTICAL
 Job No. : SZNS1211111-58026E-RF
 Test Mode: 2.4G WIFI Transmitting

	Freq	Factor	Read Level	Level	Limit	Over	Remark
	MHz	dB/m	dBuV	dBuV/m	dBuV/m	dB	
1	32.65	-12.07	46.00	34.53	40.00	-5.47	QP
2	57.90	-9.92	39.87	29.95	40.00	-10.05	QP
3	117.67	-13.09	42.06	28.97	43.50	-14.53	QP
4	326.02	-8.21	40.71	32.50	46.00	-13.50	QP
5	539.00	-4.01	39.93	35.92	46.00	-10.08	QP
6	852.90	0.34	35.23	35.57	46.00	-10.43	QP

Adapter 4:

Horizontal:

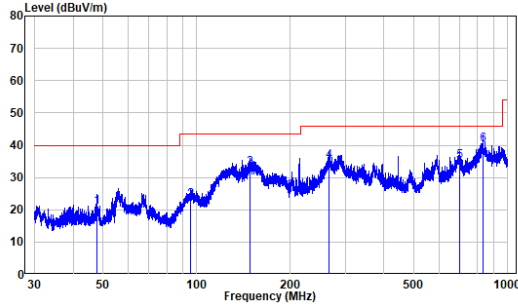

Site : chamber
 Condition: 3m HORIZONTAL
 Job No. : SZNS1211111-58026E-RF
 Test Mode: 2.4G WIFI Transmitting

	Freq	Factor	Read Level	Level	Limit Line	Over Limit	Remark
	MHz	dB/m	dBuV	dBuV/m	dBuV/m	dB	
1	47.81	-10.00	30.76	20.76	40.00	-19.24	QP
2	95.43	-12.40	35.38	22.98	43.50	-20.52	QP
3	148.31	-15.36	48.12	32.76	43.50	-10.74	QP
4	266.84	-10.37	45.35	34.98	46.00	-11.02	QP
5	699.00	-1.61	36.66	35.05	46.00	-10.95	QP
6	831.86	0.09	39.97	40.06	46.00	-5.94	QP

Vertical

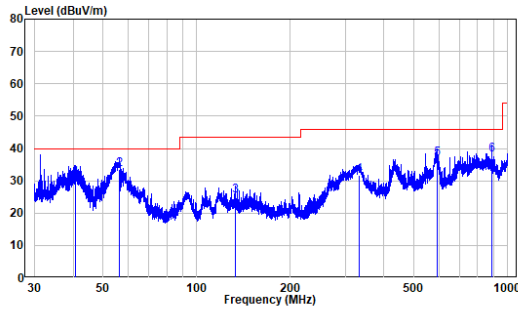

Site : chamber
 Condition: 3m VERTICAL
 Job No. : SZNS1211111-58026E-RF
 Test Mode: 2.4G WIFI Transmitting

	Freq	Factor	Read Level	Level	Limit Line	Over Limit	Remark
	MHz	dB/m	dBuV	dBuV/m	dBuV/m	dB	
1	40.84	-10.20	41.03	30.83	40.00	-9.17	QP
2	56.54	-10.11	43.60	33.49	40.00	-6.51	QP
3	133.09	-14.98	40.36	25.38	43.50	-18.12	QP
4	332.08	-7.83	39.64	31.81	46.00	-14.19	QP
5	593.57	-2.71	39.61	36.90	46.00	-9.10	QP
6	890.34	0.94	37.02	37.96	46.00	-8.04	QP

2TX Mode (Worst case)**1-25 GHz:**

Frequency (MHz)	Receiver		Turntable Degree	Rx Antenna		Corrected Factor (dB/m)	Corrected Amplitude (dBμV/m)	Limit (dBμV/m)	Margin (dB)
	Reading (dBμV)	PK/QP/Ave		Height (m)	Polar (H/V)				
802.11B, Low Channel									
2310	52.55	PK	341	1.4	H	-7.23	45.32	74	-28.68
2310	53.12	PK	285	1.8	V	-7.23	45.89	74	-28.11
2390	53.06	PK	153	1.3	H	-7.21	45.85	74	-28.15
2390	57.97	PK	89	1.3	V	-7.21	50.76	74	-23.24
4824	46.18	PK	217	1.2	H	-3.53	42.65	74	-31.35
4824	47.51	PK	299	1.4	V	-3.53	43.98	74	-30.02
802.11B, Middle Channel									
4874	44.91	PK	261	1.6	H	-3.42	41.49	74	-32.51
4874	46.63	PK	295	2.2	V	-3.42	43.21	74	-30.79
11B, High Channel									
2483.5	52.44	PK	350	2	H	-7.2	45.24	74	-28.76
2483.5	50.44	PK	80	2.4	V	-7.2	43.24	74	-30.76
2500	53.38	PK	49	1.4	H	-7.18	46.2	74	-27.8
2500	55.45	PK	3	1.1	V	-7.18	48.27	74	-25.73
4924	45.38	PK	122	1.9	H	-3.16	42.22	74	-31.78
4924	45.94	PK	138	1.7	V	-3.16	42.78	74	-31.22
802.11G, Low Channel									
2310	51.53	PK	270	2.2	H	-7.23	44.3	74	-29.7
2310	53.81	PK	241	1.2	V	-7.23	46.58	74	-27.42
2390	52.25	PK	165	2	H	-7.21	45.04	74	-28.96
2390	54.81	PK	295	2.1	V	-7.21	47.6	74	-26.4
4824	47	PK	75	1.2	H	-3.53	43.47	74	-30.53
4824	45.67	PK	186	1	V	-3.53	42.14	74	-31.86
802.11G, Middle Channel									
4874	46.7	PK	131	1.1	H	-3.42	43.28	74	-30.72
4874	47.58	PK	337	1.4	V	-3.42	44.16	74	-29.84
802.11G, High Channel									
2483.5	51.75	PK	145	1.9	H	-7.2	44.55	74	-29.45
2483.5	50.28	PK	263	2.3	V	-7.2	43.08	74	-30.92
2500	48.6	PK	259	2	H	-7.18	41.42	74	-32.58
2500	45.92	PK	6	1.5	V	-7.18	38.74	74	-35.26
4924	45.33	PK	141	1.1	H	-3.16	42.17	74	-31.83
4924	47.05	PK	336	1.5	V	-3.16	43.89	74	-30.11
802.11N20, Low Channel									
2310	53.59	PK	244	1.9	H	-7.23	46.36	74	-27.64
2310	55.1	PK	133	1	V	-7.23	47.87	74	-26.13
2390	52.89	PK	40	1.2	H	-7.21	45.68	74	-28.32
2390	55.82	PK	323	1	V	-7.21	48.61	74	-25.39
4824	45.01	PK	176	1.5	H	-3.53	41.48	74	-32.52
4824	44.92	PK	322	1.8	V	-3.53	41.39	74	-32.61
802.11N20, Middle Channel									
4874	49.05	PK	65	1.6	H	-3.42	45.63	74	-28.37
4874	48.7	PK	134	1.5	V	-3.42	45.28	74	-28.72
802.11N20, High Channel									
2483.5	55.79	PK	264	1.1	H	-7.2	48.59	74	-25.41

2483.5	61.08	PK	36	2.2	V	-7.2	53.88	74	-20.12
2500	54.29	PK	344	1.9	H	-7.18	47.11	74	-26.89
2500	56.1	PK	107	1.4	V	-7.18	48.92	74	-25.08
4924	46.63	PK	309	2.1	H	-3.16	43.47	74	-30.53
4924	46.3	PK	12	2.5	V	-3.16	43.14	74	-30.86
802.11N40, Low Channel									
2310	54.41	PK	129	1.4	H	-7.23	47.18	74	-26.82
2310	53.77	PK	237	2.5	V	-7.23	46.54	74	-27.46
2390	53.07	PK	173	2.5	H	-7.21	45.86	74	-28.14
2390	60.87	PK	12	1.1	V	-7.21	53.66	74	-20.34
4844	44.11	PK	322	2.5	H	-3.53	40.58	74	-33.42
4844	47.1	PK	287	1.6	V	-3.53	43.57	74	-30.43
802.11N40, Middle Channel									
4874	47.3	PK	18	1.8	H	-3.42	43.88	74	-30.12
4874	46.67	PK	332	2.3	V	-3.42	43.25	74	-30.75
802.11N40, High Channel									
2483.5	56.82	PK	1	1.2	H	-7.2	49.62	74	-24.38
2483.5	61.35	PK	255	1.7	V	-7.2	54.15	74	-19.85
2483.5	50.89	AV	199	1.5	V	-7.2	43.69	54	-10.31
2500	56.07	PK	228	1.3	H	-7.18	48.89	74	-25.11
2500	56.33	PK	173	2.5	V	-7.18	49.15	74	-24.85
4904	45.63	PK	235	2.1	H	-3.16	42.47	74	-31.53
4904	46.79	PK	177	1.8	V	-3.16	43.63	74	-30.37

Bluetooth & 2.4G Wi-Fi (802.11b mode, 2437MHz) & 5G Wi-Fi (802.11ac20 mode, 5180MHz) Simultaneously Transmission:

Frequency (MHz)	Receiver		Turntable Degree	Rx Antenna		Corrected Factor (dB/m)	Corrected Amplitude (dB μ V/m)	Limit (dB μ V/m)	Margin (dB)
	Reading (dB μ V)	PK/QP/Ave.		Height (m)	Polar (H/V)				
146.63	53.05	QP	193	1.6	H	-21.71	31.34	43.5	-12.16
325.45	48.66	QP	321	2.2	V	-16.77	31.89	46	-14.11
2571.06	51.92	PK	273	1.3	H	-6.9	45.02	74	-28.98
2716.74	50.36	PK	259	2.4	V	-6.6	43.76	74	-30.24

Note:

Corrected Factor = Antenna factor (RX) + Cable Loss – Amplifier Factor

Corrected Amplitude = Corrected Factor + Reading

Margin = Corrected Amplitude- Limit

The other spurious emission which is 20dB below to the limit was not recorded.

The test result of peak was 20dB below to the limit of peak, which can be compliant to the average limit, so just peak value was recorded.

1-18 GHz:

Pre-scan plots:

802.11 N20 Middle Channel
Horizontal

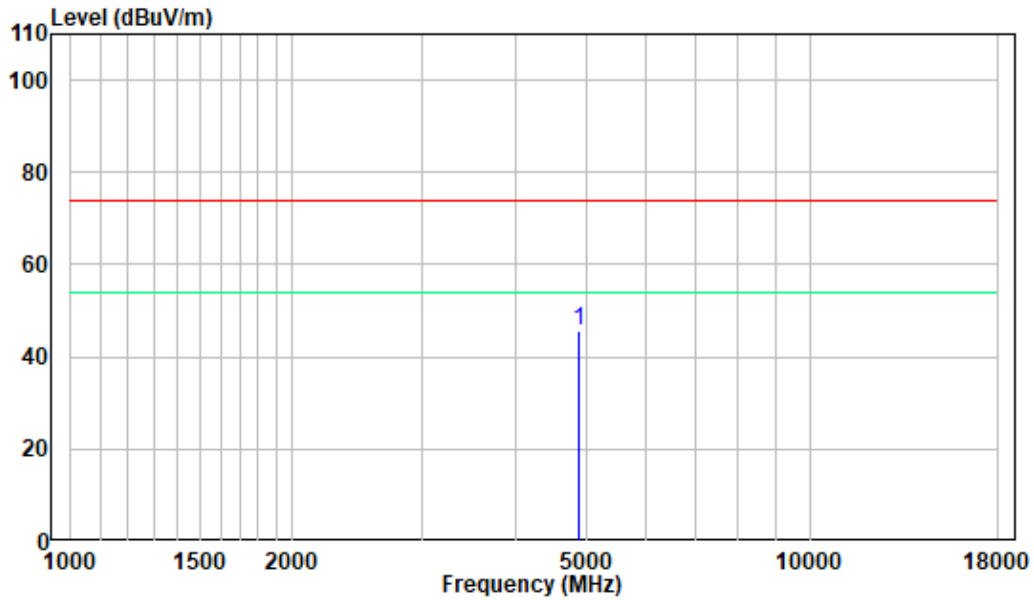

Vertical

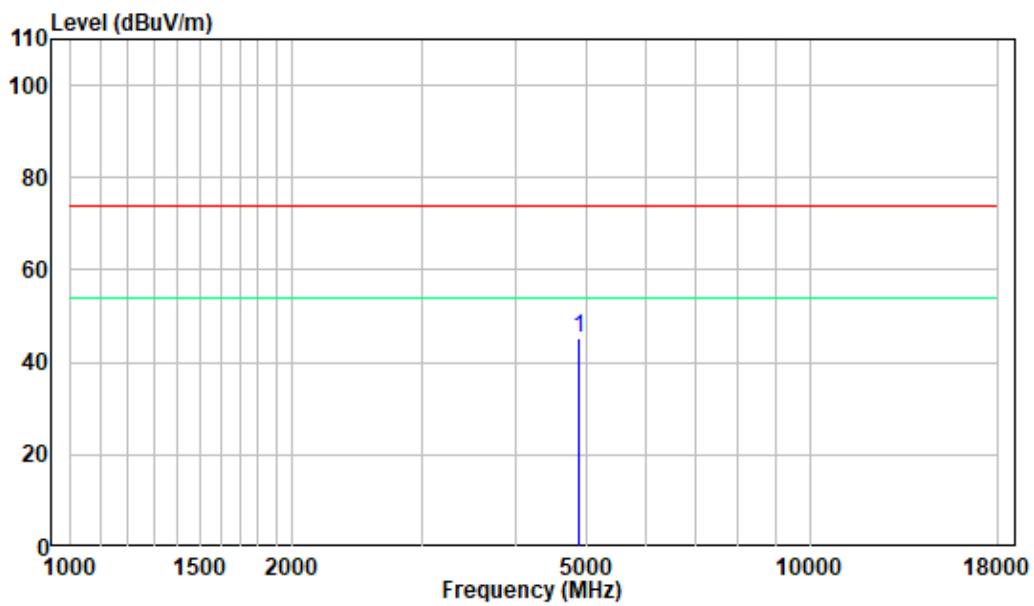

18 -25GHz:

Pre-scan plots:

**802.11 N20 Middle Channel
Horizontal**

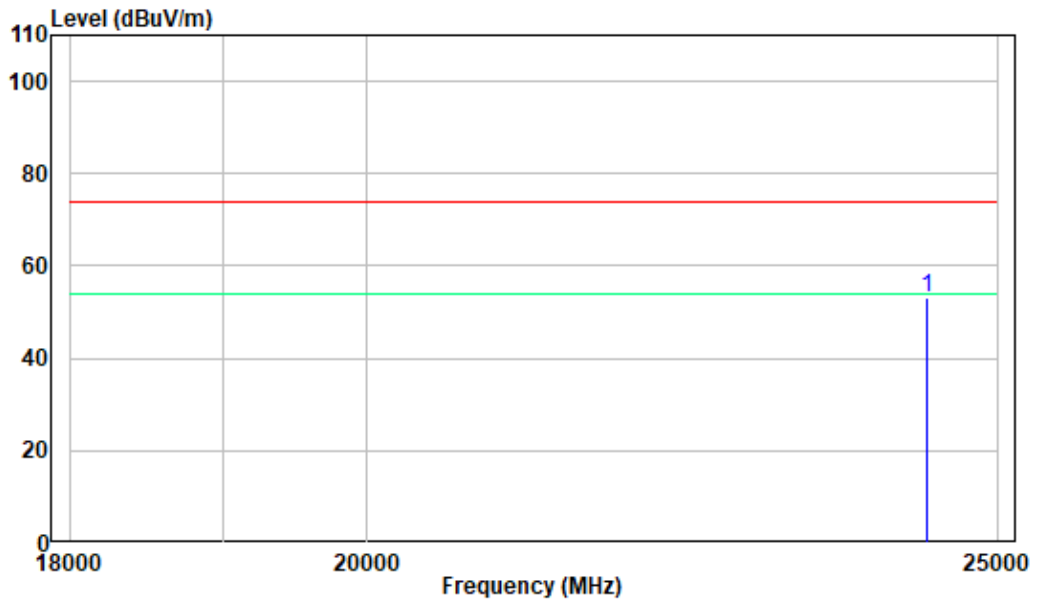

Vertical

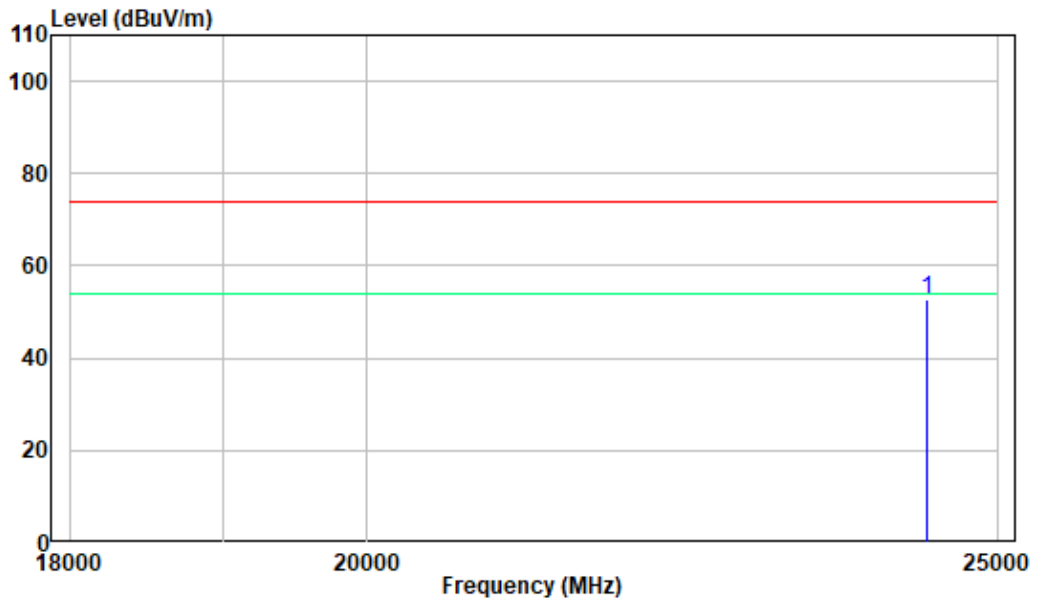

FCC §15.247(a) (2) – 6 dB EMISSION BANDWIDTH & OCCUPIED BANDWIDTH

Applicable Standard

Systems using digital modulation techniques may operate in the 902–928 MHz, 2400–2483.5 MHz, and 5725–5850 MHz bands. The minimum 6 dB bandwidth shall be at least 500 kHz.

Test Procedure

1. Check the calibration of the measuring instrument using either an internal calibrator or a known signal from an external generator.
2. Position the EUT without connection to measurement instrument. Turn on the EUT and connect it to measurement instrument. Then set it to any one convenient frequency within its operating range. Set a reference level on the measuring instrument equal to the highest peak value.
3. Measure the frequency difference of two frequencies that were attenuated 6 dB from the reference level. Record the frequency difference as the emission bandwidth.
4. Repeat above procedures until all frequencies measured were complete.

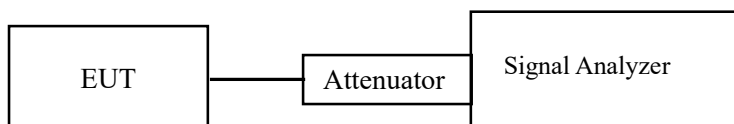

Test Data

Environmental Conditions

Temperature:	24 °C
Relative Humidity:	48 %
ATM Pressure:	101.0 kPa

The testing was performed by Fan Yang from 2021-11-23 to 2021-11-24

EUT operation mode: Transmitting

Test Result: Compliant. Please refer to the Appendix Wi-Fi.

FCC §15.247(b) (3) - MAXIMUM CONDUCTED OUTPUT POWER

Applicable Standard

According to FCC §15.247(b) (3), for systems using digital modulation in the 902-928 MHz, 2400-2483.5 MHz, and 5725-5850 MHz bands: 1 Watt. As an alternative to a peak power measurement, compliance with the one Watt limit can be based on a measurement of the maximum conducted output power. Maximum Conducted Output Power is defined as the total transmit power delivered to all antennas and antenna elements averaged across all symbols in the signaling alphabet when the transmitter is operating at its maximum power control level. Power must be summed across all antennas and antenna elements. The average must not include any time intervals during which the transmitter is off or is transmitting at a reduced power level. If multiple modes of operation are possible (e.g., alternative modulation methods), the maximum conducted output power is the highest total transmit power occurring in any mode.

Test Procedure

1. Place the EUT on a bench and set it in transmitting mode.
2. Remove the antenna from the EUT and then connect a low loss RF cable from the antenna port to one test equipment.
3. Add a correction factor to the display.

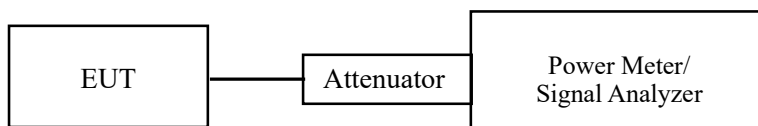

Test Data

Environmental Conditions

Temperature:	24 °C
Relative Humidity:	48 %
ATM Pressure:	101.0 kPa

The testing was performed by Fan Yang on from 2021-11-23 to 2021-11-24

EUT operation mode: Transmitting

Test Result: Compliant. Please refer to the Appendix Wi-Fi.

FCC §15.247(d) – 100 kHz BANDWIDTH OF FREQUENCY BAND EDGE**Applicable Standard**

In any 100 kHz bandwidth outside the frequency band in which the spread spectrum or digitally modulated intentional radiator is operating, the radio frequency power that is produced by the intentional radiator shall be at least 20 dB below that in the 100 kHz bandwidth within the band that contains the highest level of the desired power, based on either an RF conducted or a radiated measurement, provided the transmitter demonstrates compliance with the peak conducted power limits. If the transmitter complies with the conducted power limits based on the use of RMS averaging over a time interval, as permitted under paragraph (b)(3) of this section, the attenuation required under this paragraph shall be 30 dB instead of 20 dB. Attenuation below the general limits specified in §15.209(a) is not required. In addition, radiated emissions which fall in the restricted bands, as defined in §15.205(a), must also comply with the radiated emission limits specified in §15.209(a) (see §15.205(c)).

Test Procedure

1. Check the calibration of the measuring instrument using either an internal calibrator or a known signal from an external generator.
2. Position the EUT without connection to measurement instrument. Turn on the EUT and connect its antenna terminal to measurement instrument via a low loss cable. Then set it to any one measured frequency within its operating range, and make sure the instrument is operated in its linear range.
3. Set RBW to 100 kHz and VBW of spectrum analyzer to 300 kHz with a convenient frequency span including 100 kHz bandwidth from band edge.
4. Measure the highest amplitude appearing on spectral display and set it as a reference level. Plot the graph with marking the highest point and edge frequency.
5. Repeat above procedures until all measured frequencies were complete.

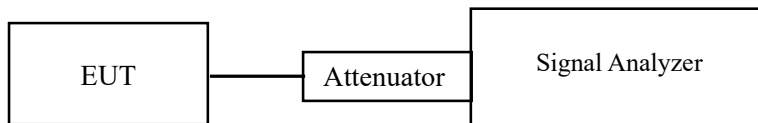
**Test Data****Environmental Conditions**

Temperature:	24 °C
Relative Humidity:	48 %
ATM Pressure:	101.0 kPa

The testing was performed by Fan Yang on from 2021-11-23 to 2021-11-24

EUT operation mode: Transmitting

Test Result: Compliant.

Conducted Band Edge Result:

Please refer to the Appendix Wi-Fi.

FCC §15.247(e) - POWER SPECTRAL DENSITY

Applicable Standard

For digitally modulated systems, the power spectral density conducted from the intentional radiator to the antenna shall not be greater than 8 dBm in any 3 kHz band during any time interval of continuous transmission. This power spectral density shall be determined in accordance with the provisions of paragraph (b) of this section. The same method of determining the conducted output power shall be used to determine the power spectral density.

Test Procedure

1. Use this procedure when the maximum peak conducted output power in the fundamental emission is used to demonstrate compliance.
2. Set the RBW to: $3\text{kHz} \leq \text{RBW} \leq 100\text{ kHz}$.
3. Set the VBW $\geq 3 \times \text{RBW}$.
4. Set the span to 1.5 times the DTS bandwidth.
5. Detector = peak.
6. Sweep time = auto couple.
7. Trace mode = max hold.
8. Allow trace to fully stabilize.
9. Use the peak marker function to determine the maximum amplitude level within the RBW.
10. If measured value exceeds limit, reduce RBW (no less than 3 kHz) and repeat.

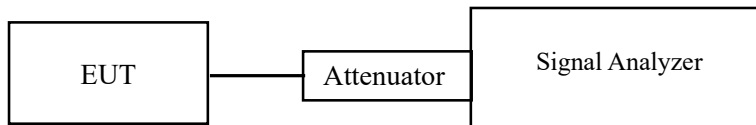

Test Data

Environmental Conditions

Temperature:	24 °C
Relative Humidity:	48 %
ATM Pressure:	101.0 kPa

The testing was performed by Fan Yang on from 2021-11-23 to 2021-11-24

EUT operation mode: Transmitting

Test Result: Compliant. Please refer to the Appendix Wi-Fi.

APPENDIX Wi-Fi**Appendix A: 6dB Emission Bandwidth****Test Result**

TestMode	Antenna	Channel [MHz]	DTS BW [MHz]	Limit[MHz]	Verdict
11B	Ant0	2412	10.160	0.5	PASS
		2437	10.160	0.5	PASS
		2462	10.160	0.5	PASS
11G	Ant0	2412	16.480	0.5	PASS
		2437	16.480	0.5	PASS
		2462	16.520	0.5	PASS
11N20	Ant0	2412	17.680	0.5	PASS
		2437	17.680	0.5	PASS
		2462	17.640	0.5	PASS
11N40	Ant0	2422	36.480	0.5	PASS
		2437	36.480	0.5	PASS
		2452	36.480	0.5	PASS

TestMode	Antenna	Channel [MHz]	DTS BW [MHz]	Limit[MHz]	Verdict
11B	Ant1	2412	10.120	0.5	PASS
		2437	10.160	0.5	PASS
		2462	10.160	0.5	PASS
11G	Ant1	2412	16.400	0.5	PASS
		2437	16.440	0.5	PASS
		2462	16.400	0.5	PASS
11N20	Ant1	2412	17.680	0.5	PASS
		2437	17.640	0.5	PASS
		2462	17.680	0.5	PASS
11N40	Ant1	2422	36.480	0.5	PASS
		2437	36.480	0.5	PASS
		2452	36.480	0.5	PASS

Test Graphs

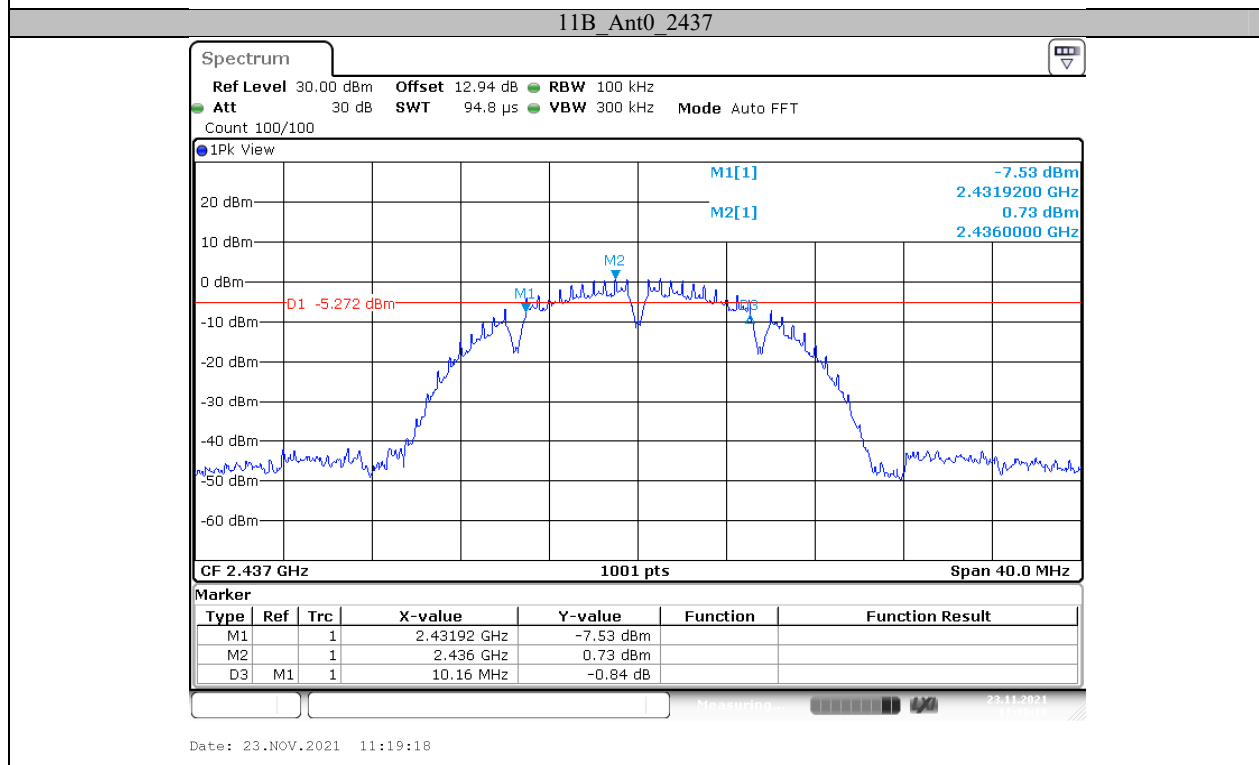
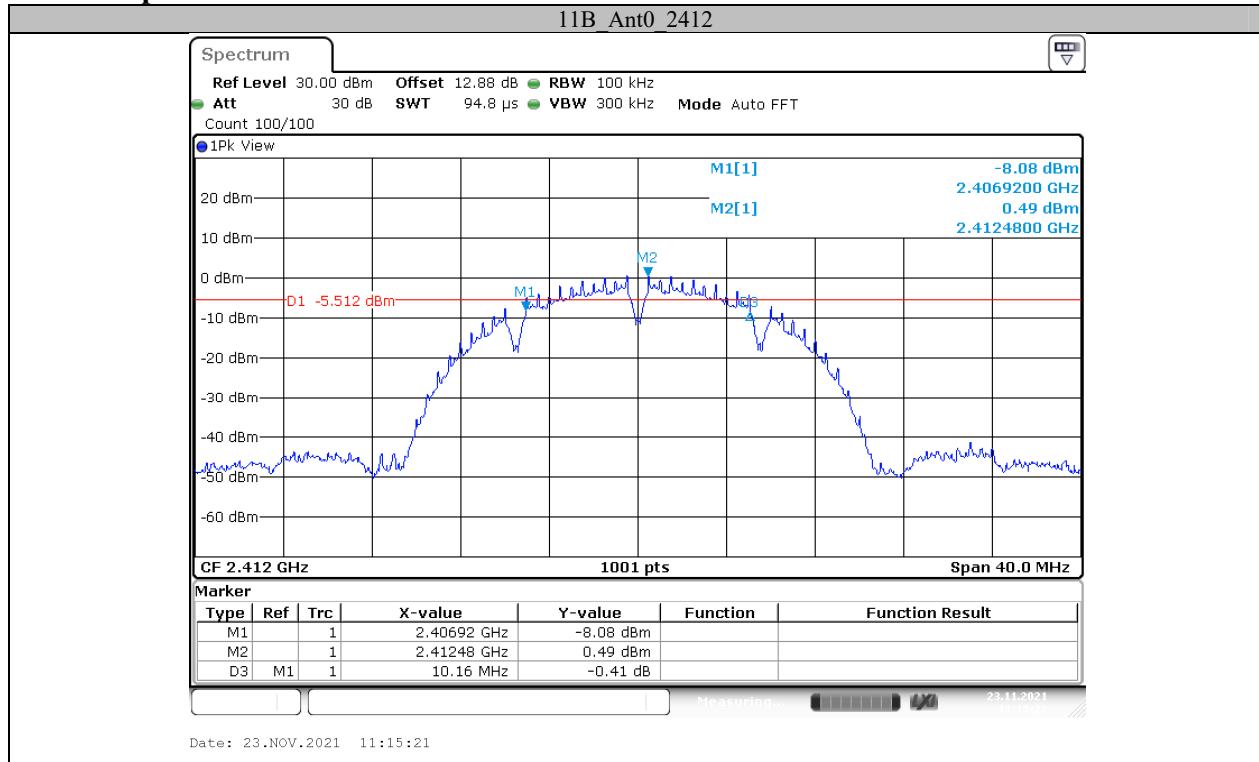

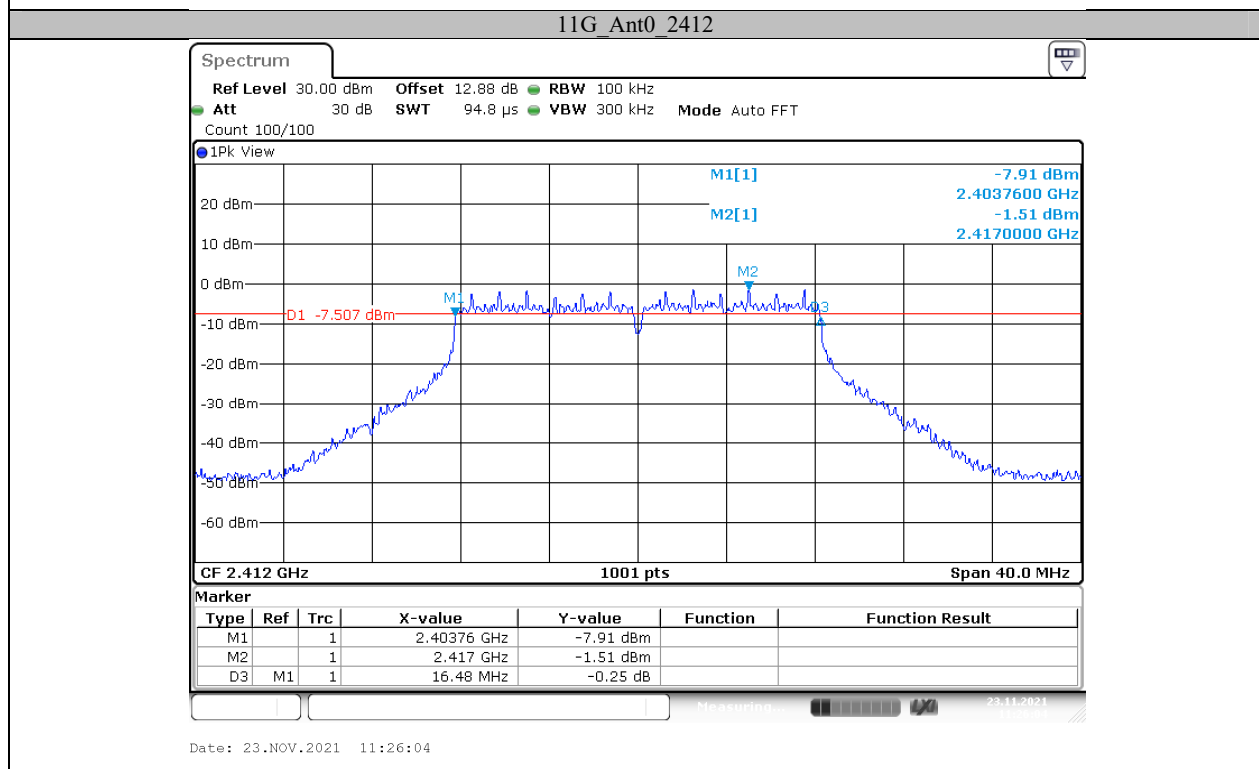
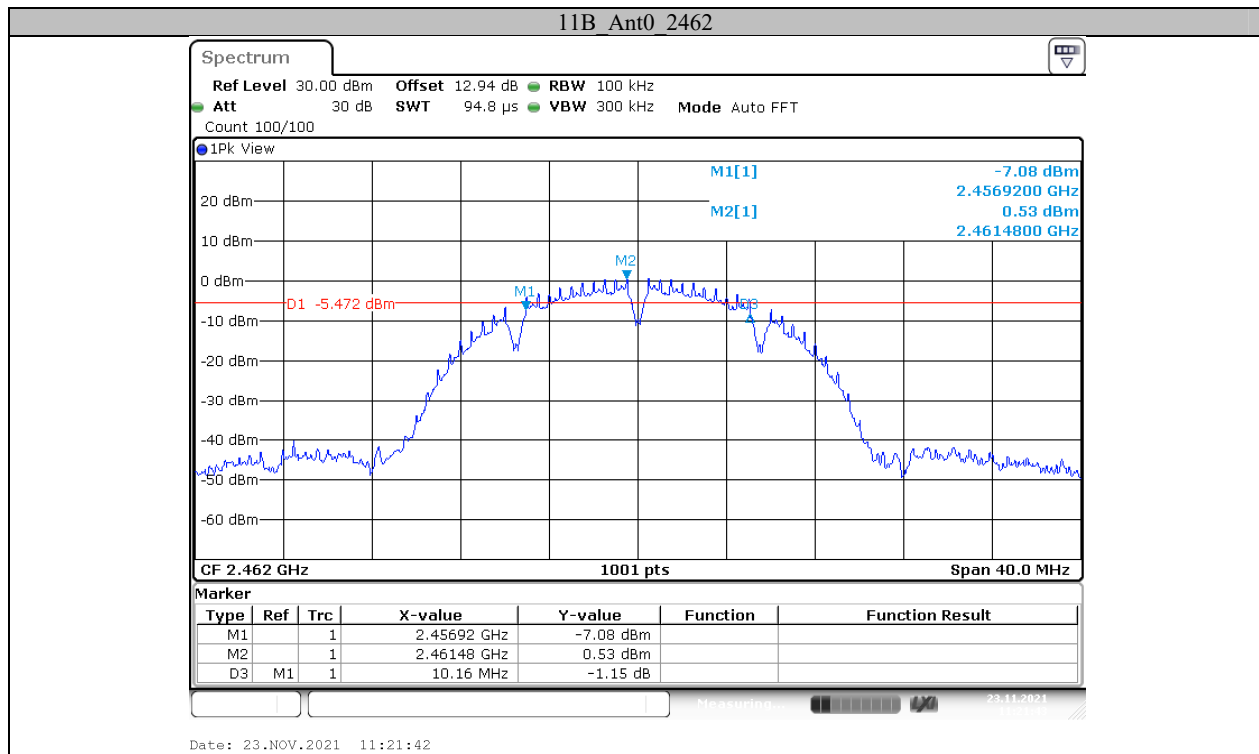

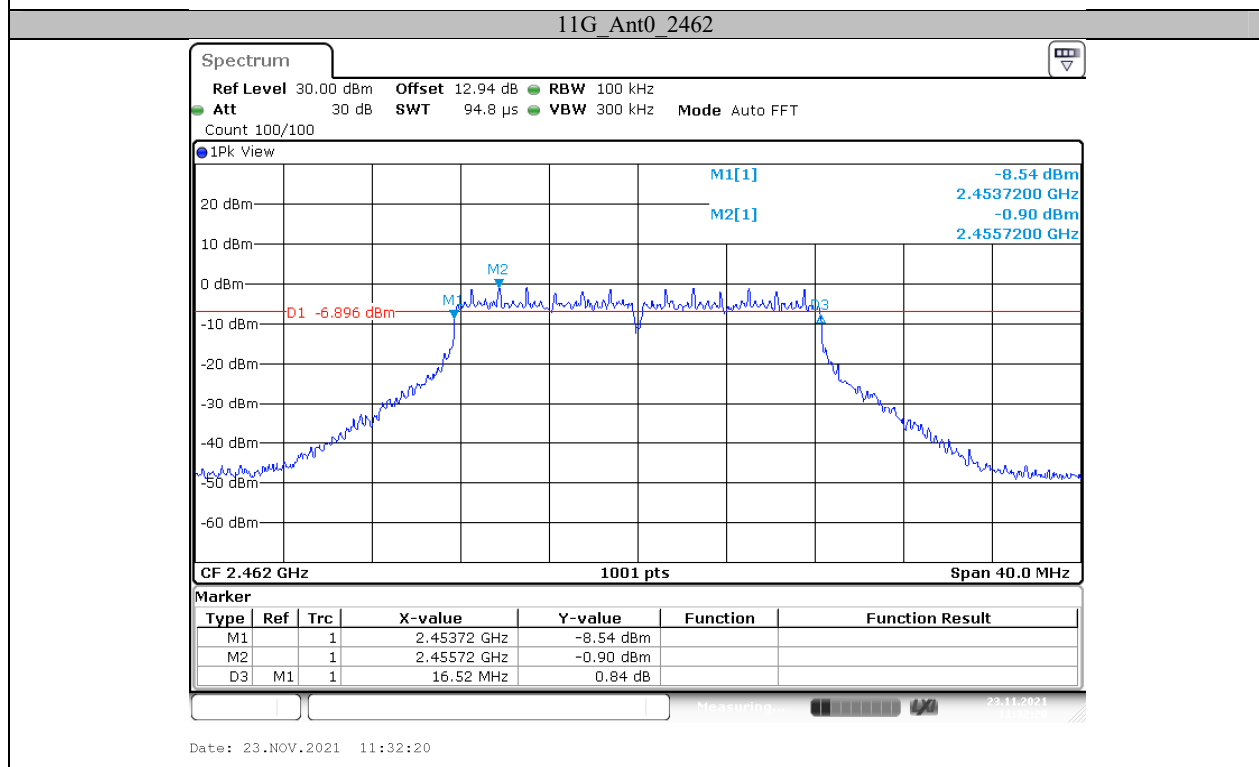
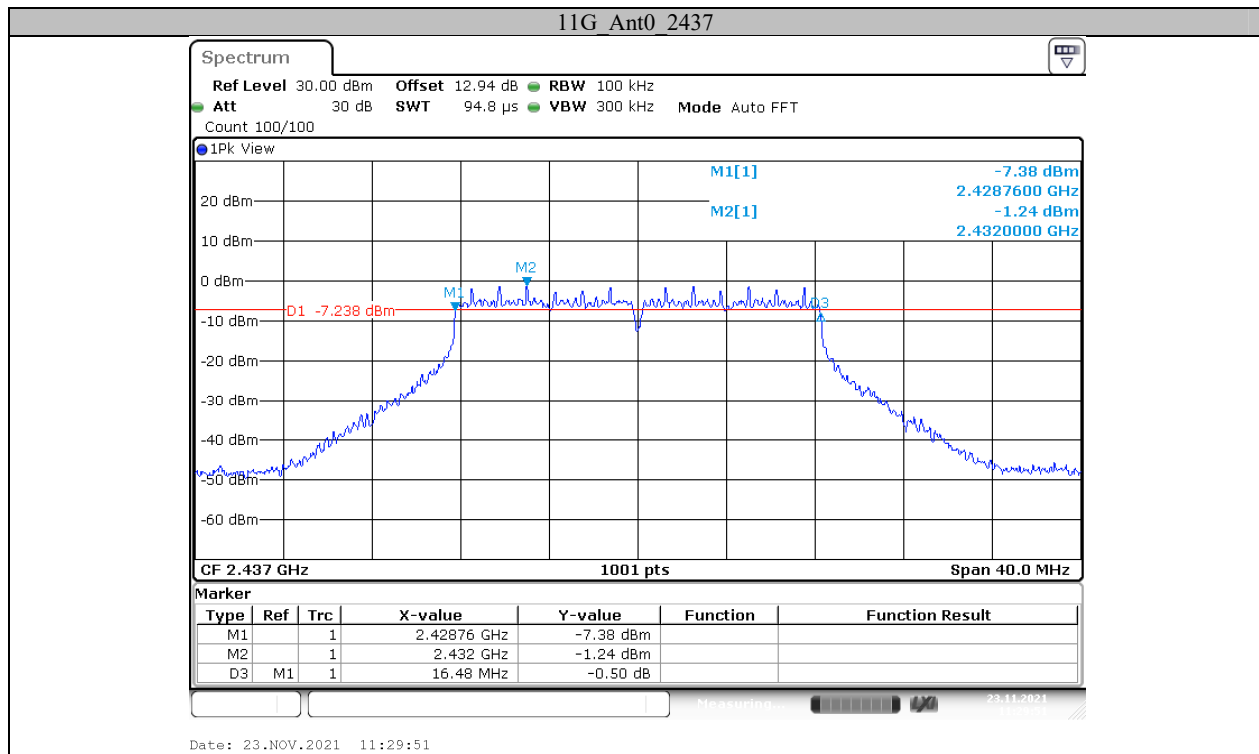

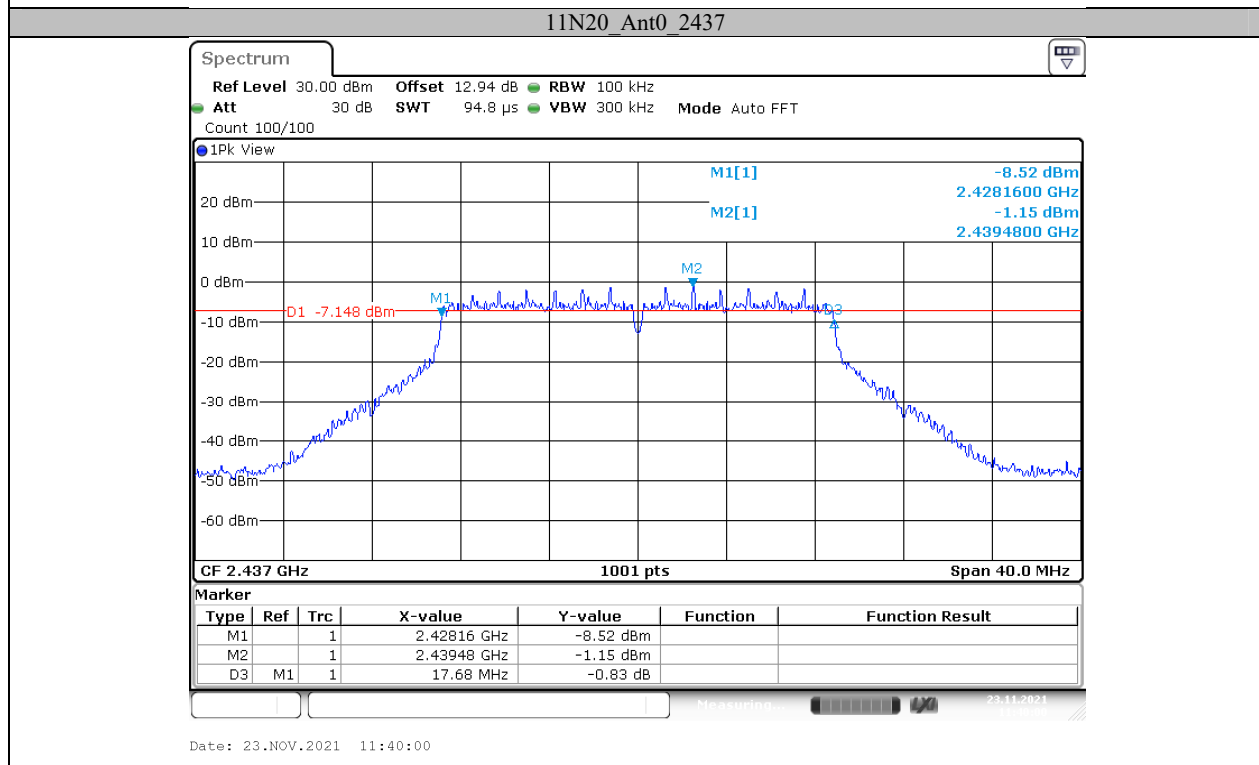
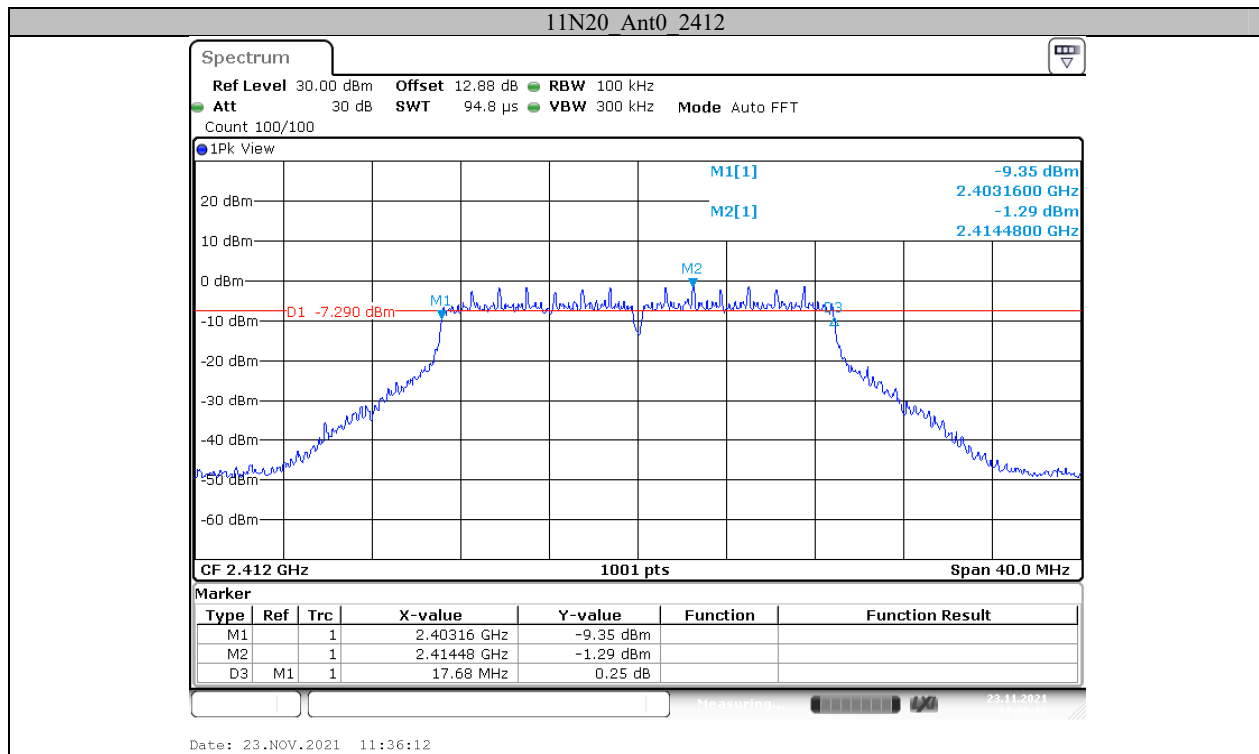

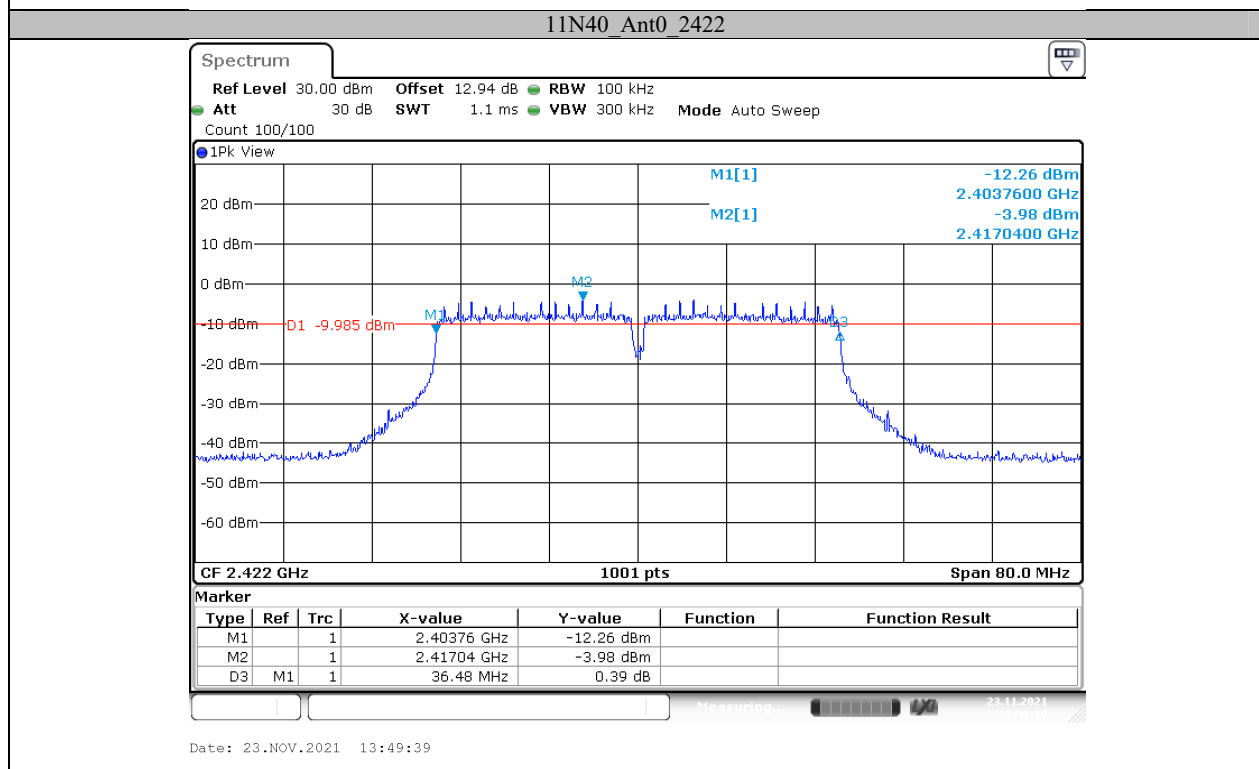
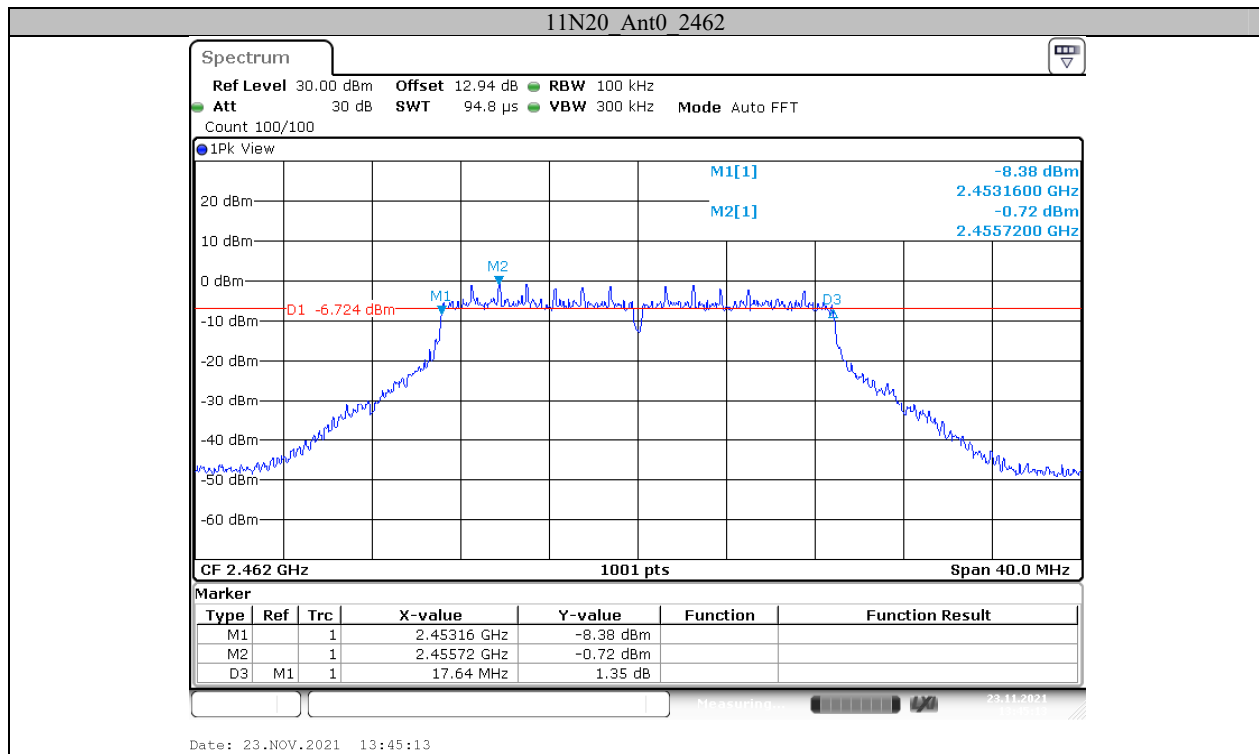

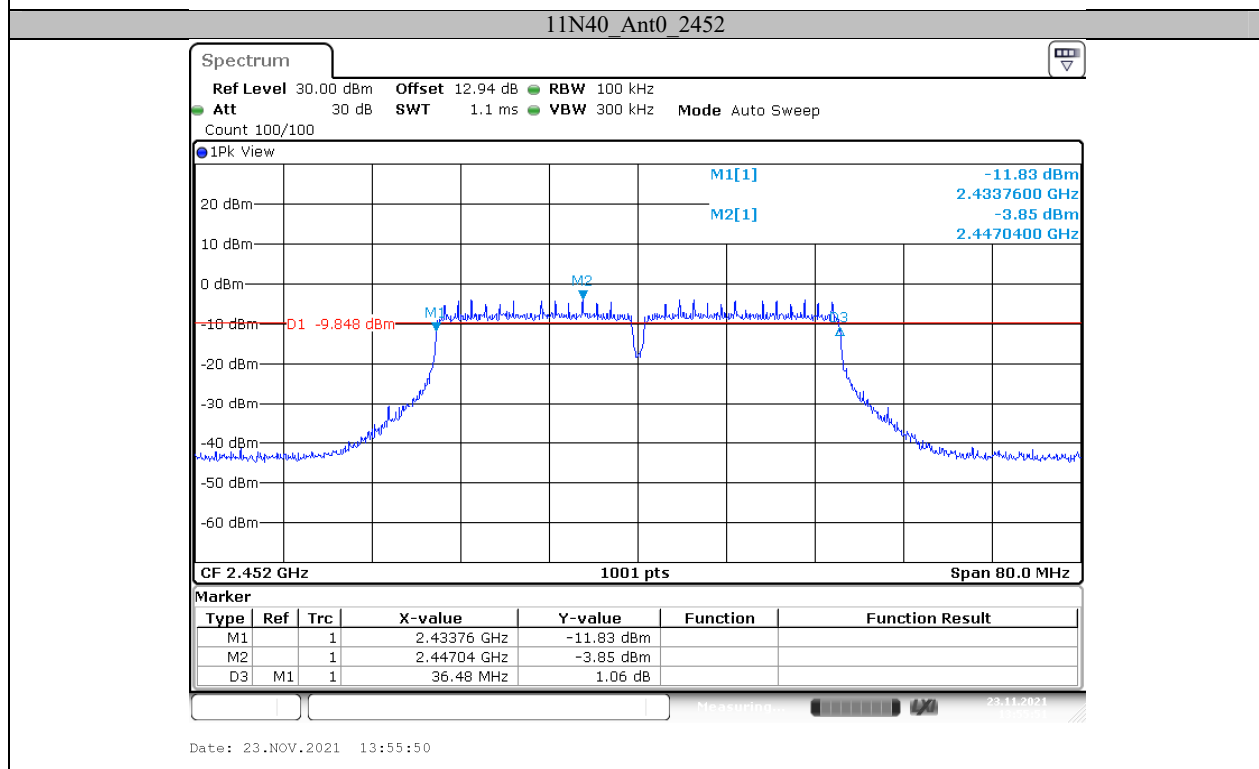
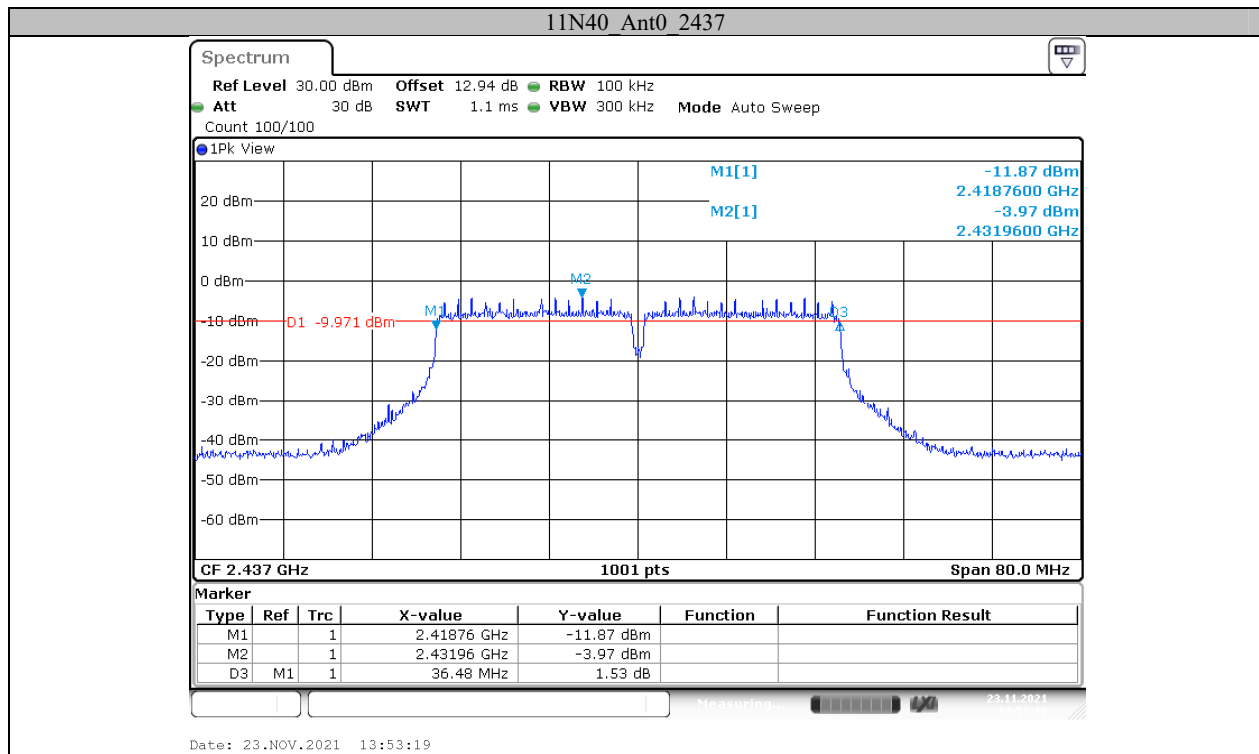

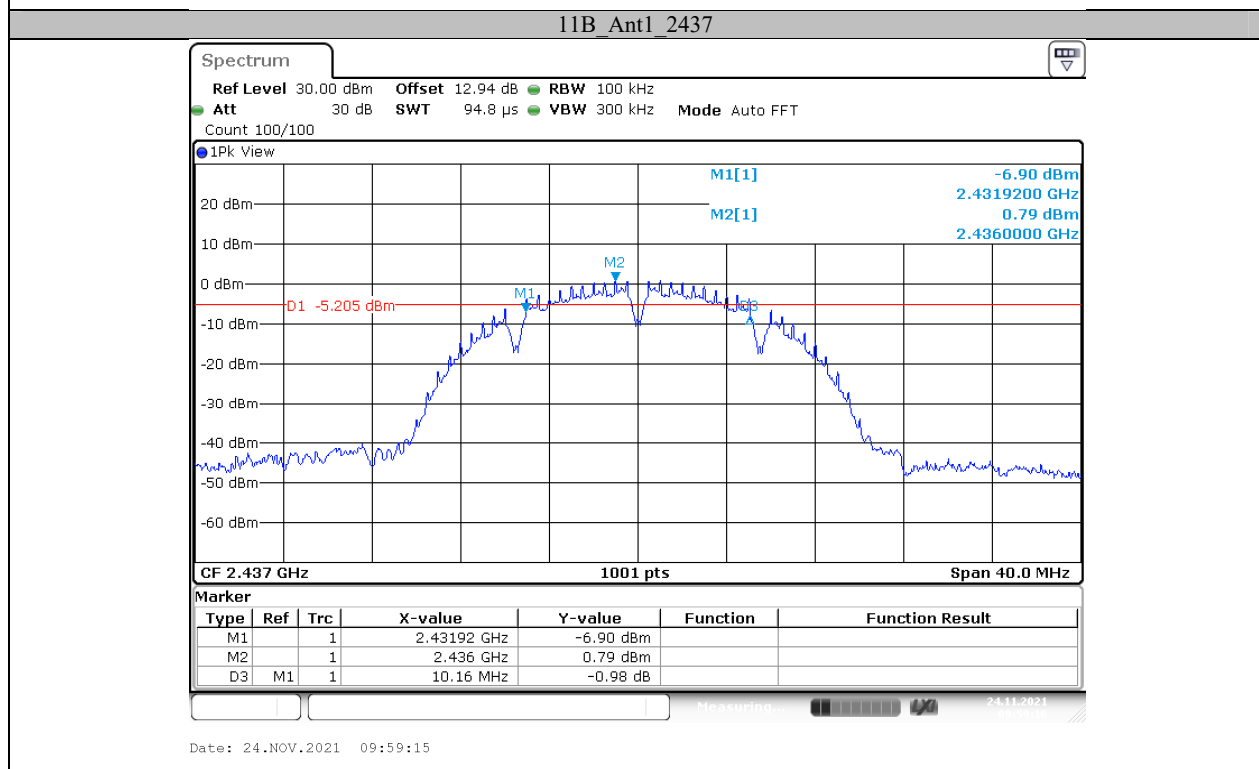
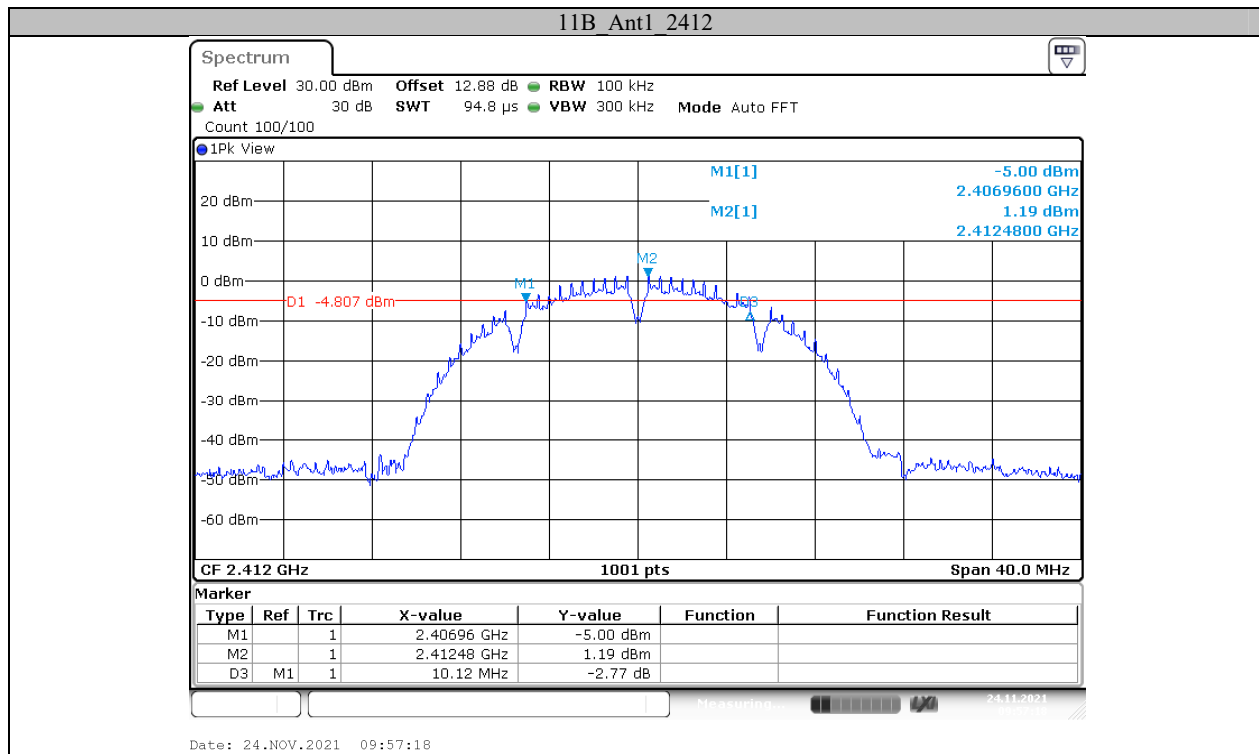

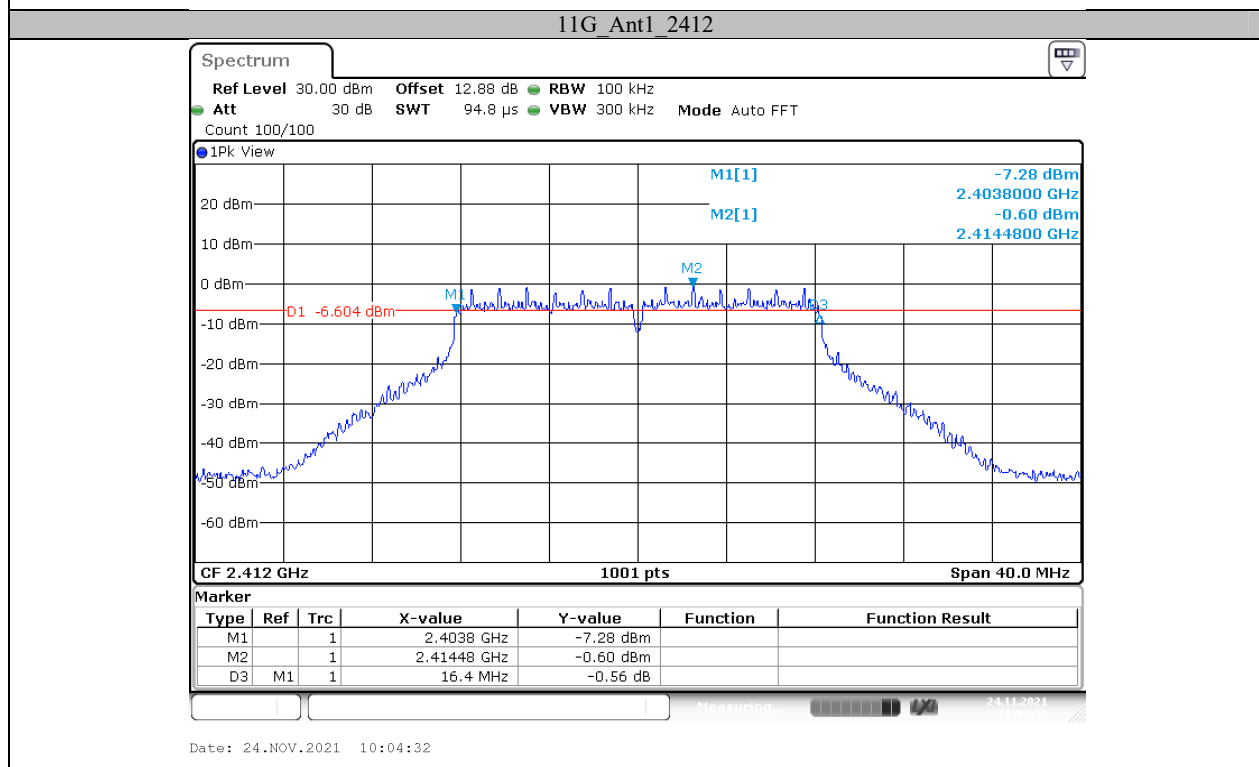
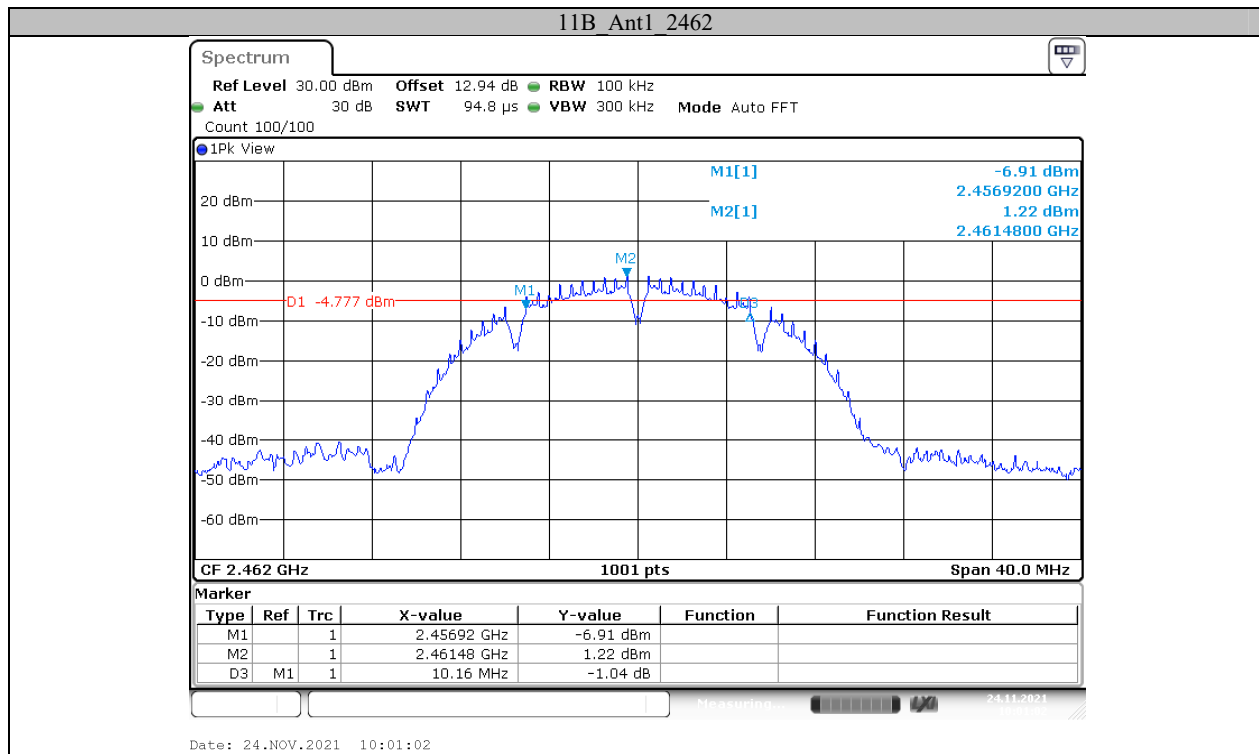

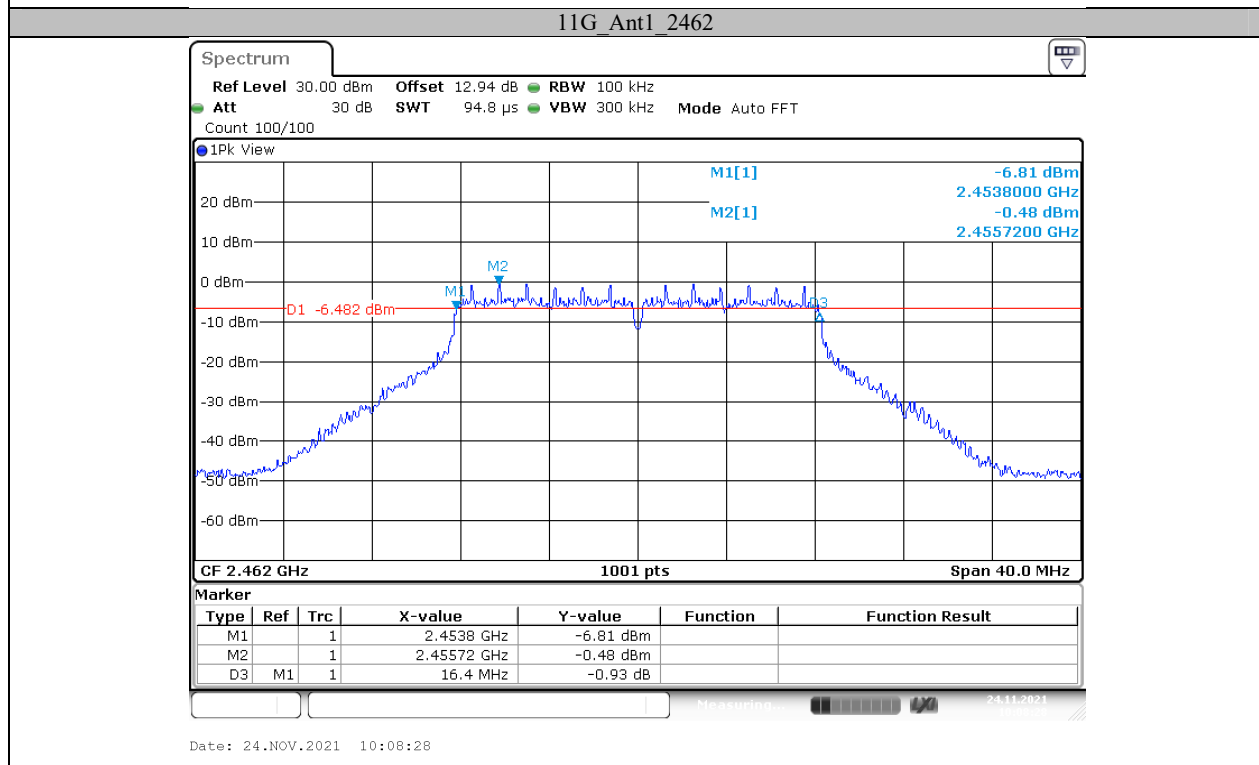
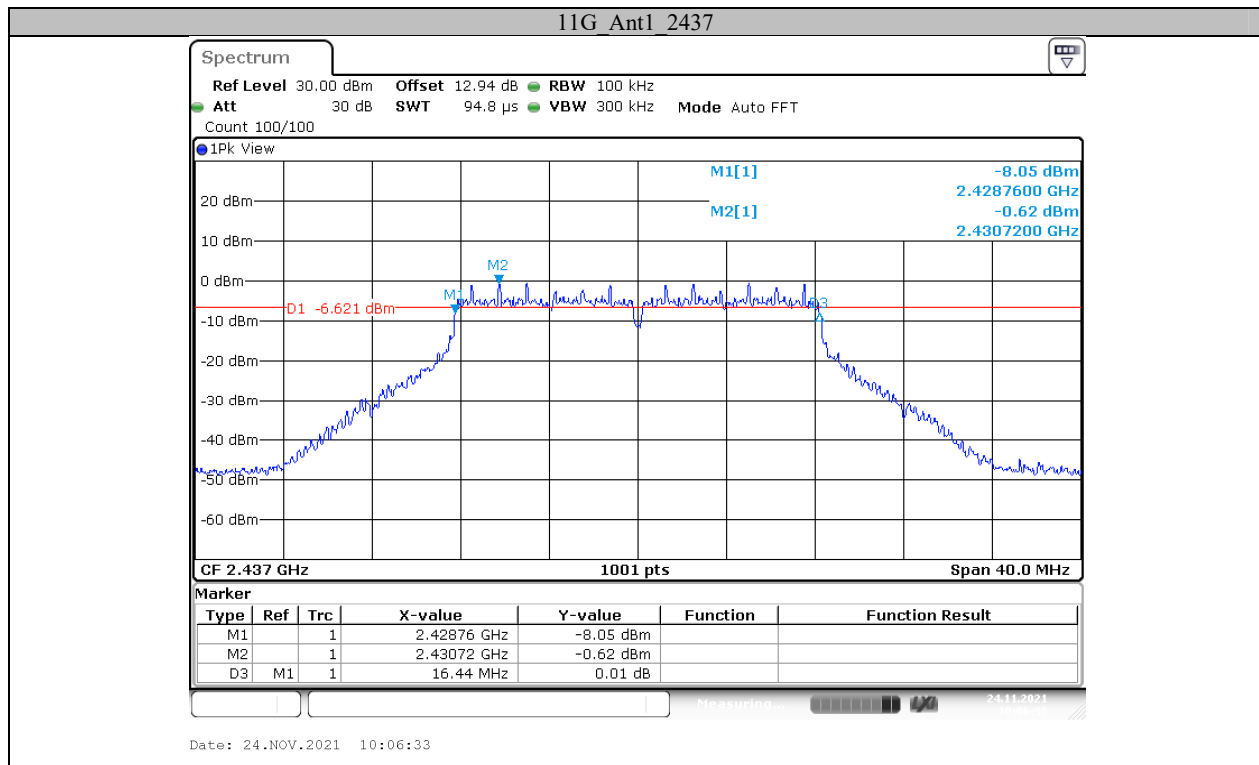

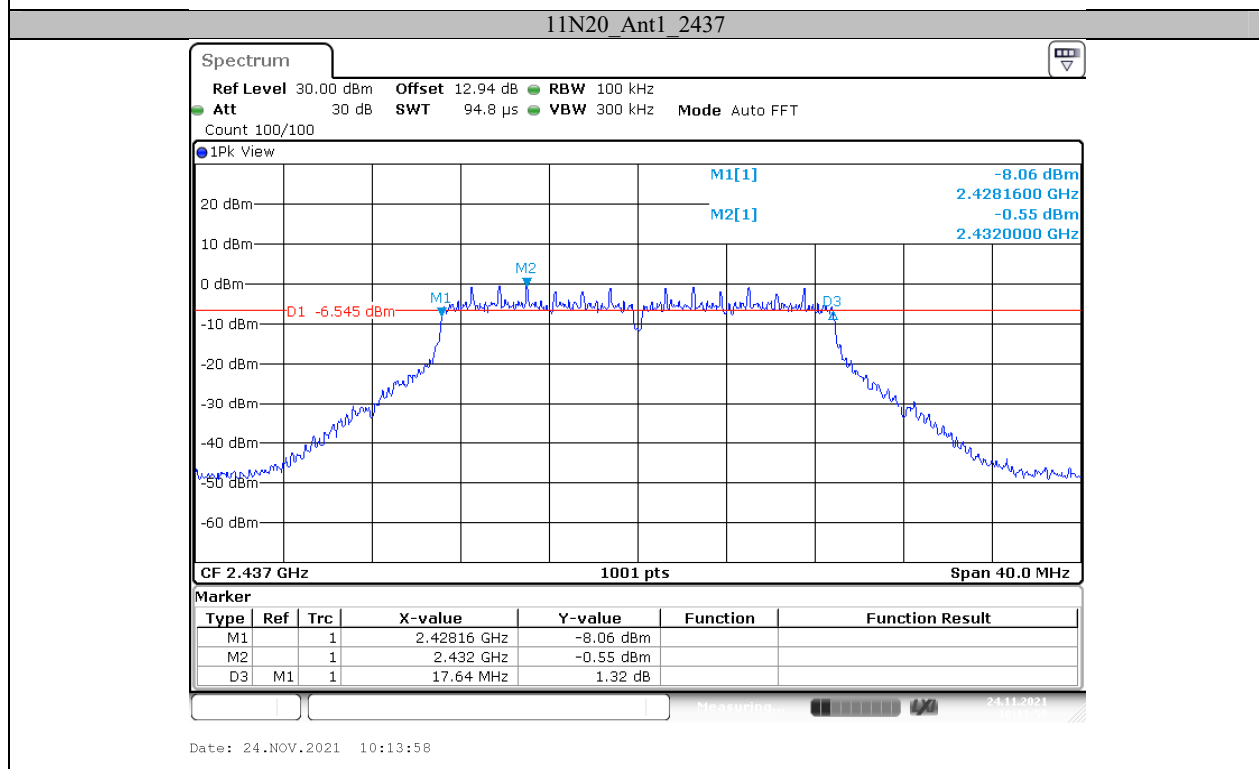
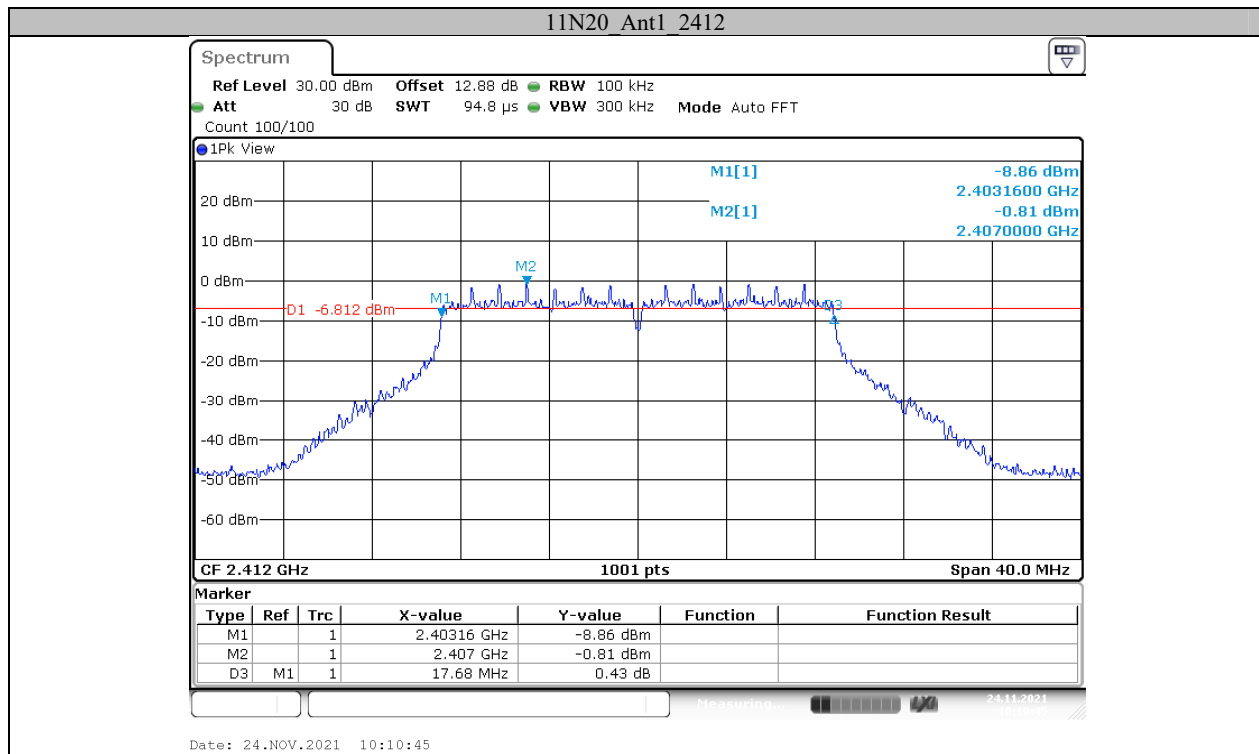

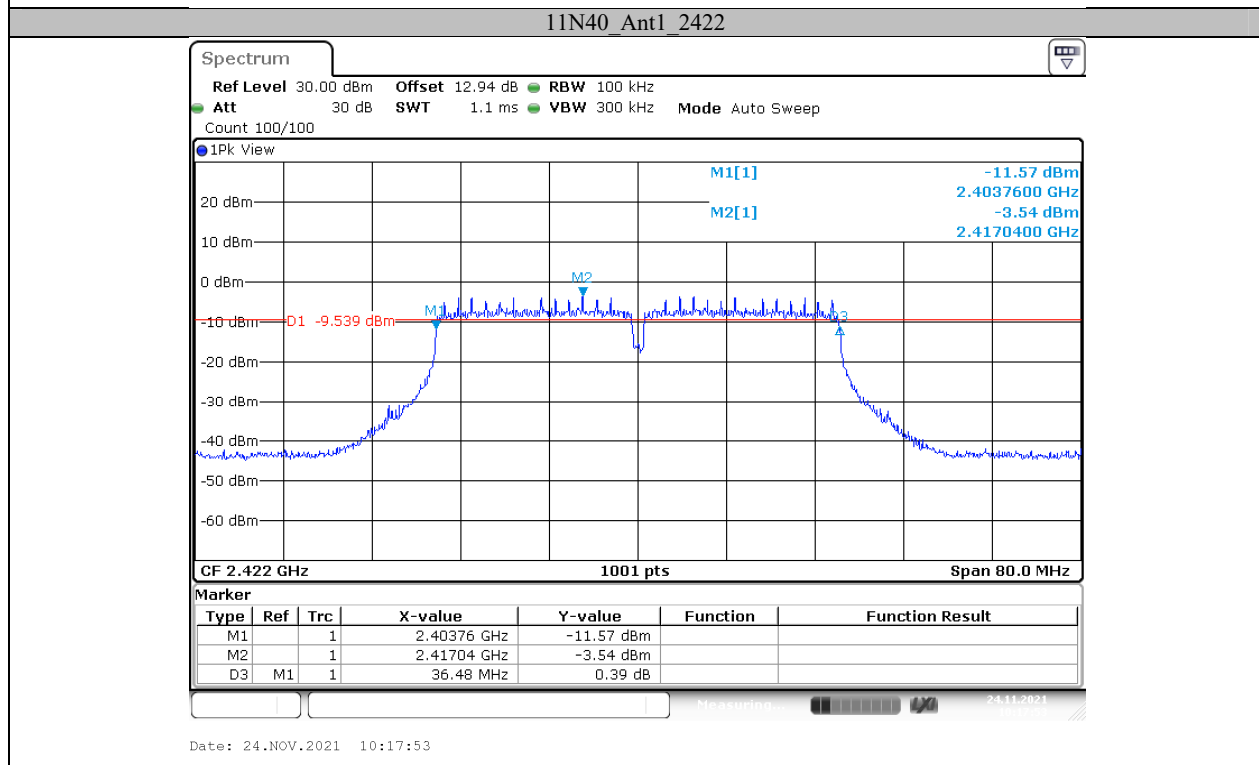
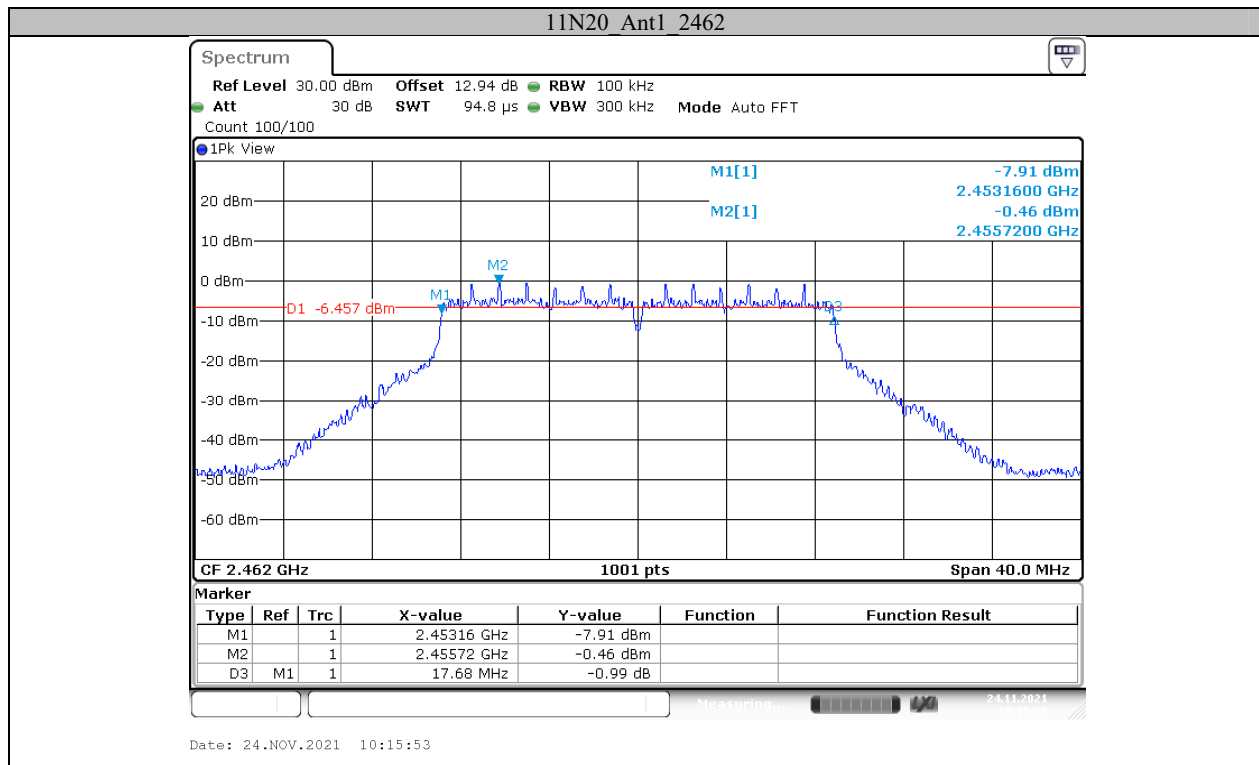

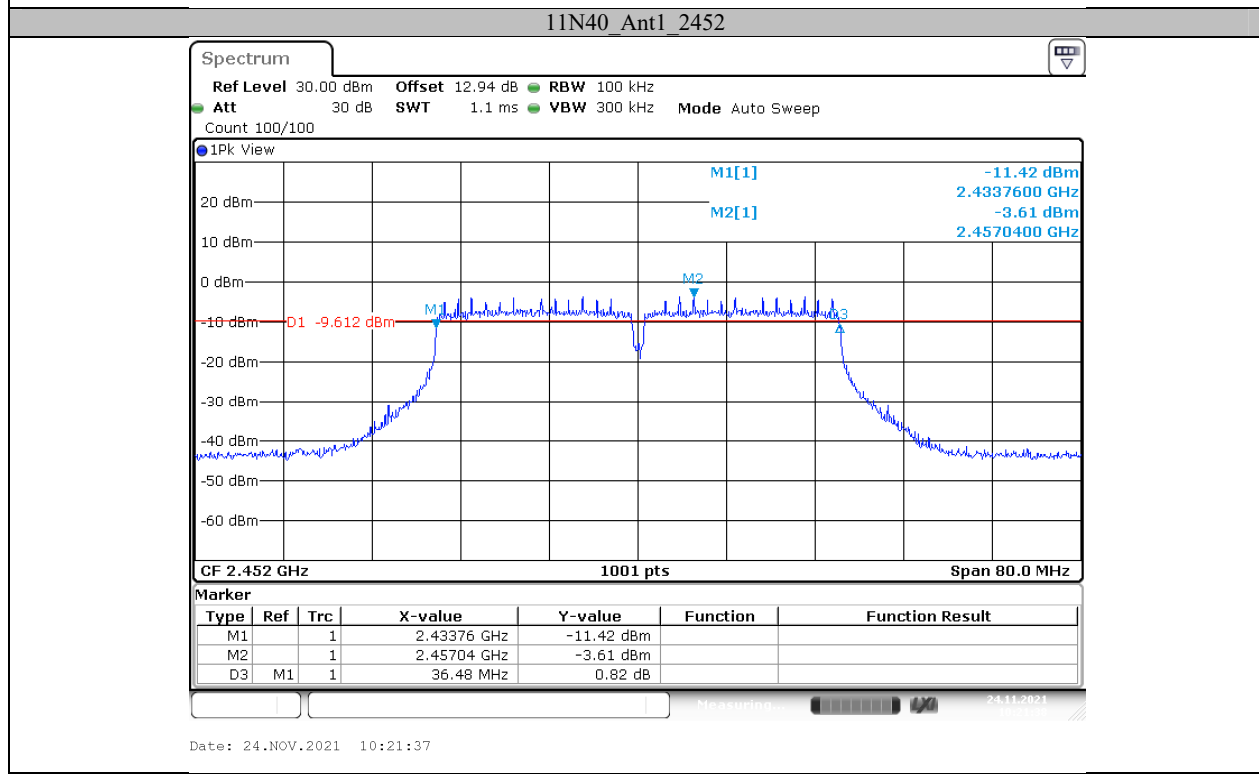
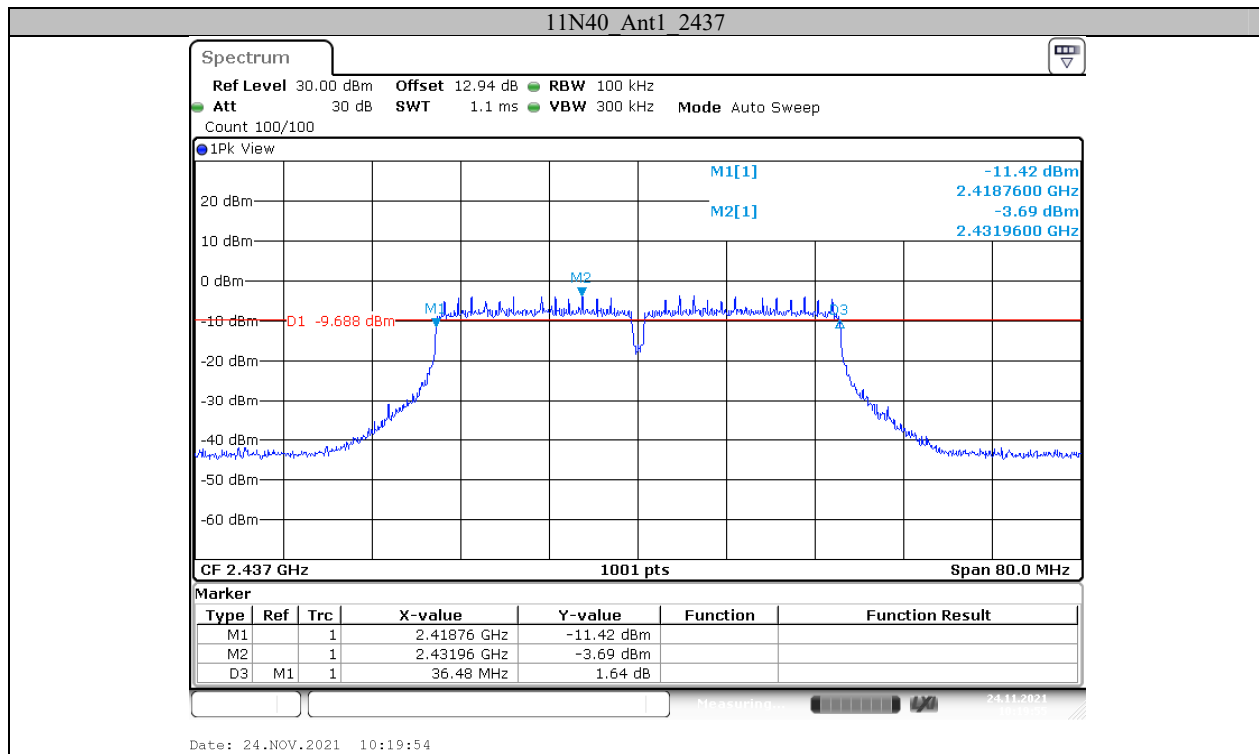

Appendix B: Occupied Channel Bandwidth**Test Result**

TestMode	Antenna	Channel[MHz]	OCB [MHz]	Limit[MHz]	Verdict
11B	Ant0	2412	15.025	---	PASS
		2437	15.025	---	PASS
		2462	15.025	---	PASS
11G	Ant0	2412	17.223	---	PASS
		2437	17.223	---	PASS
		2462	17.223	---	PASS
11N20	Ant0	2412	18.661	---	PASS
		2437	18.661	---	PASS
		2462	18.661	---	PASS
11N40	Ant0	2422	36.843	---	PASS
		2437	36.843	---	PASS
		2452	36.923	---	PASS

TestMode	Antenna	Channel[MHz]	OCB [MHz]	Limit[MHz]	Verdict
11B	Ant1	2412	15.065	---	PASS
		2437	15.025	---	PASS
		2462	15.025	---	PASS
11G	Ant1	2412	17.702	---	PASS
		2437	17.662	---	PASS
		2462	17.742	---	PASS
11N20	Ant1	2412	18.621	---	PASS
		2437	18.621	---	PASS
		2462	18.621	---	PASS
11N40	Ant1	2422	36.843	---	PASS
		2437	36.843	---	PASS
		2452	36.923	---	PASS

Test Graphs

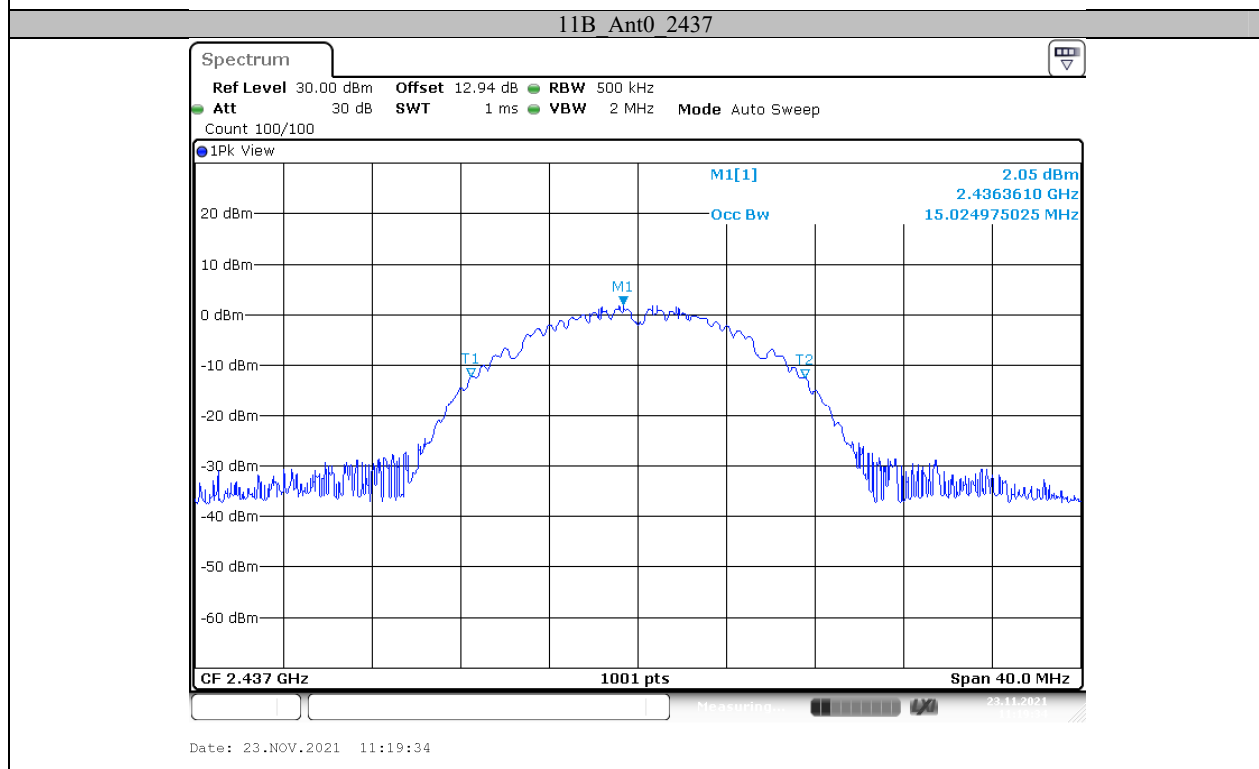
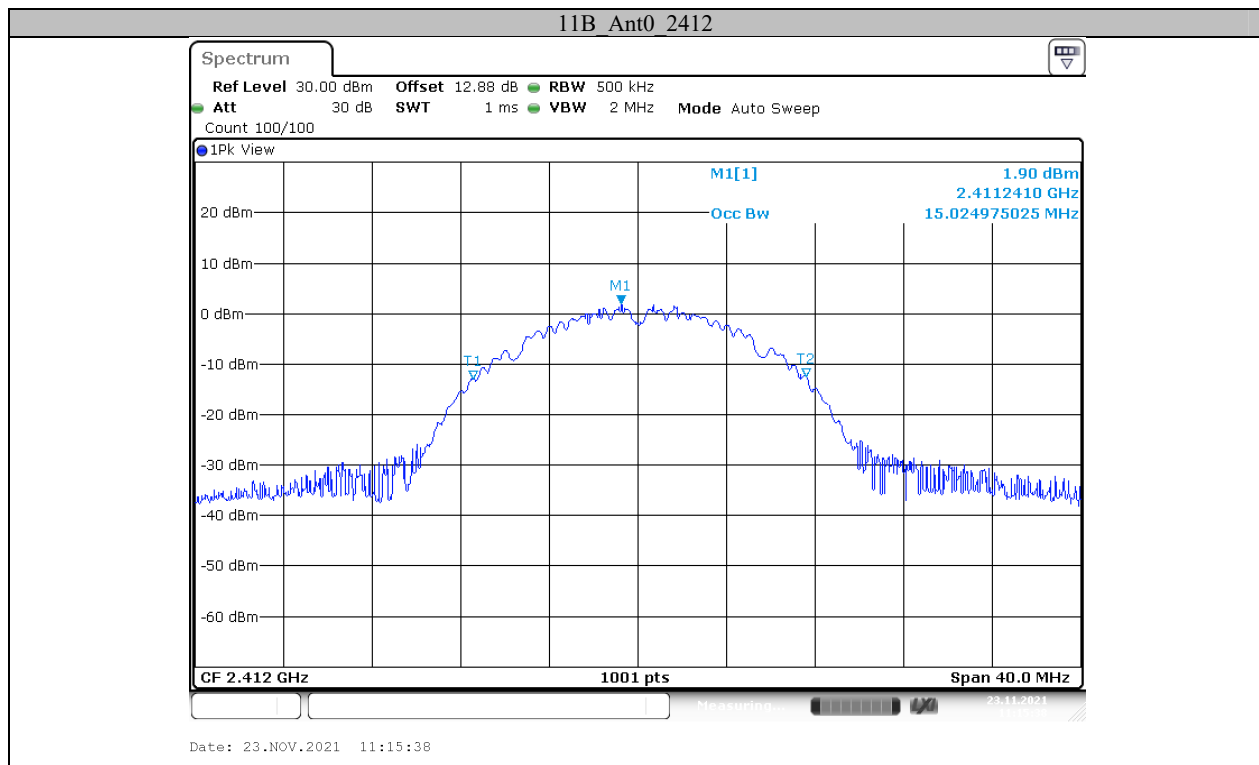

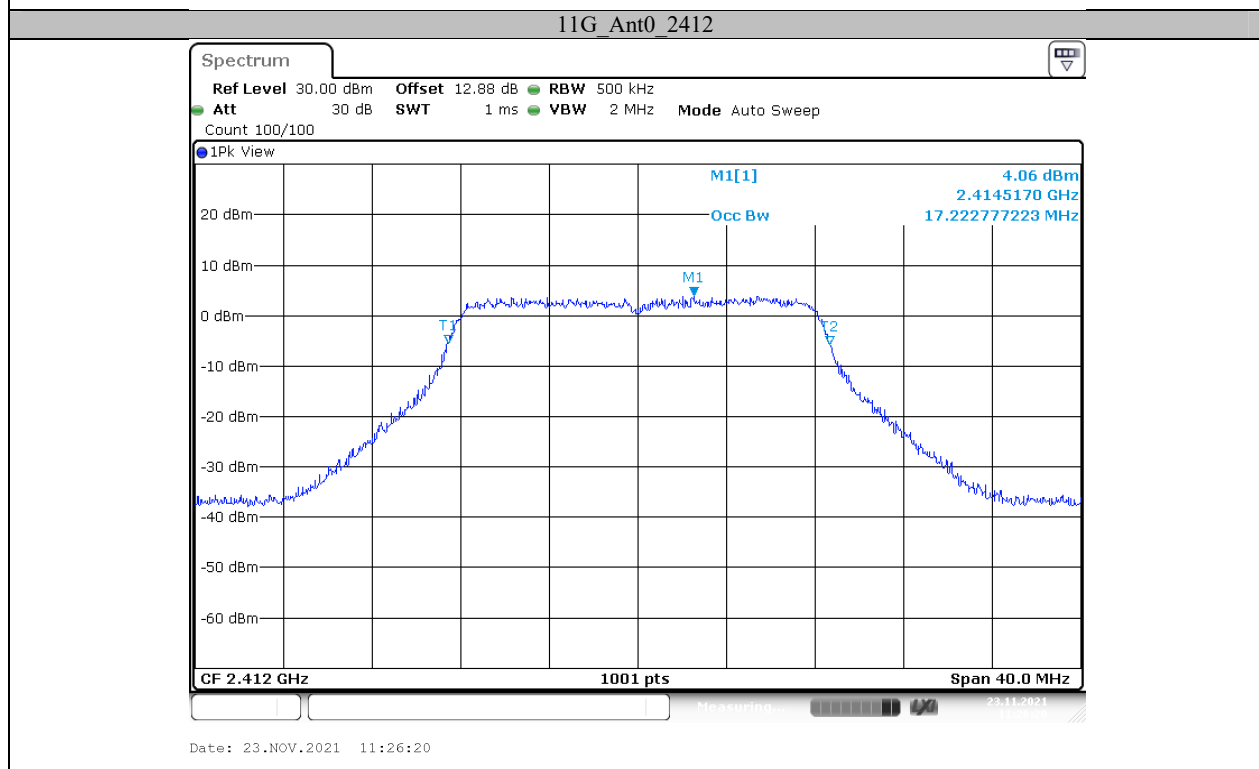
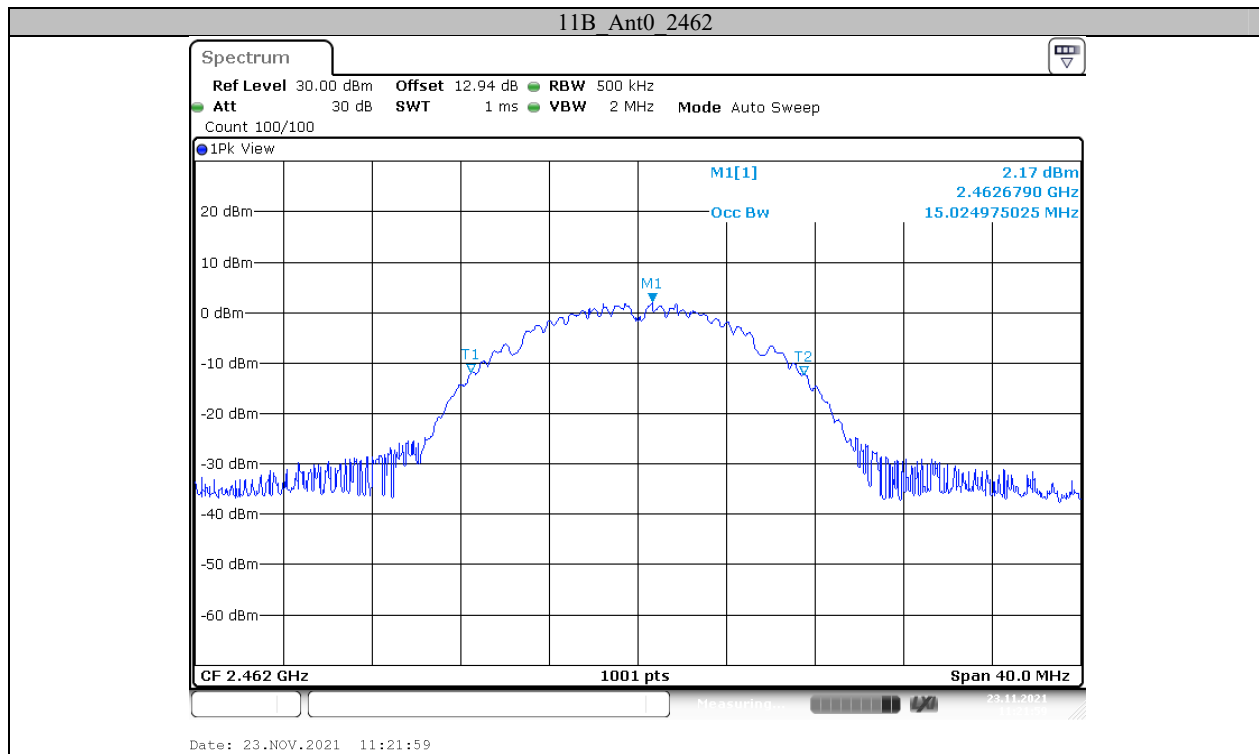

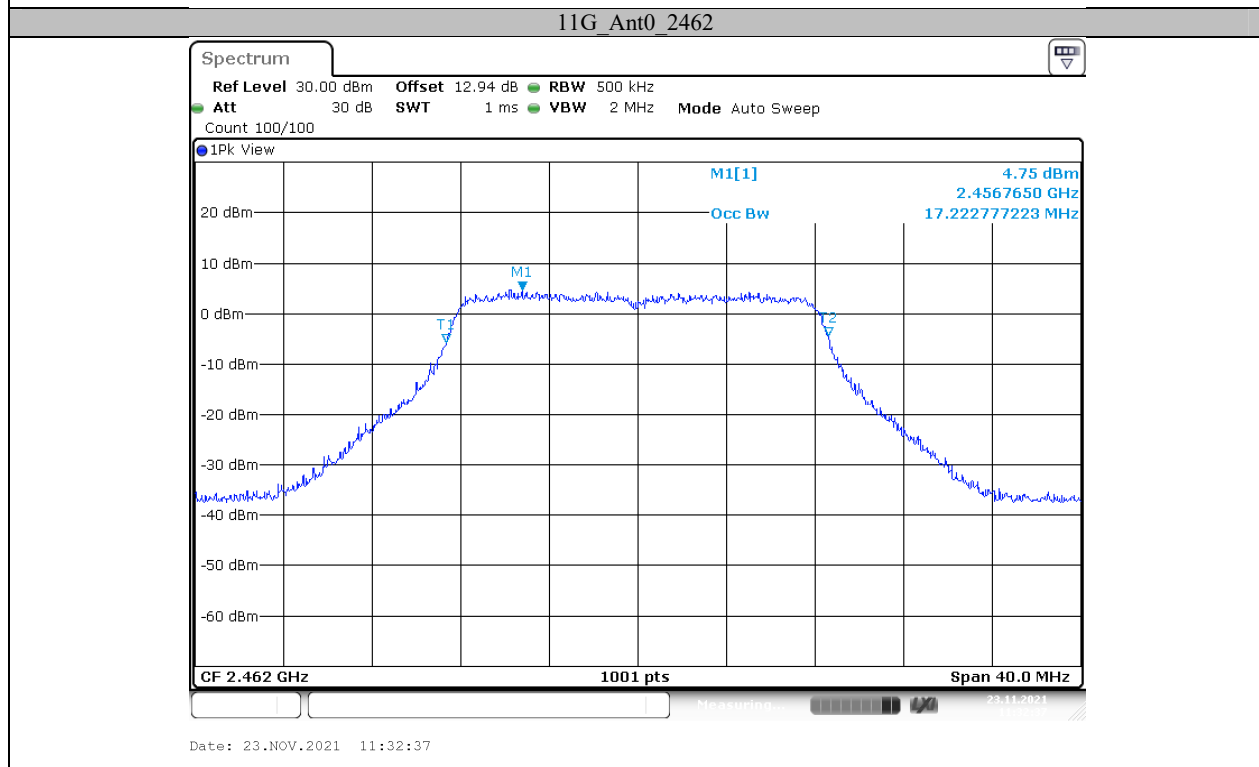
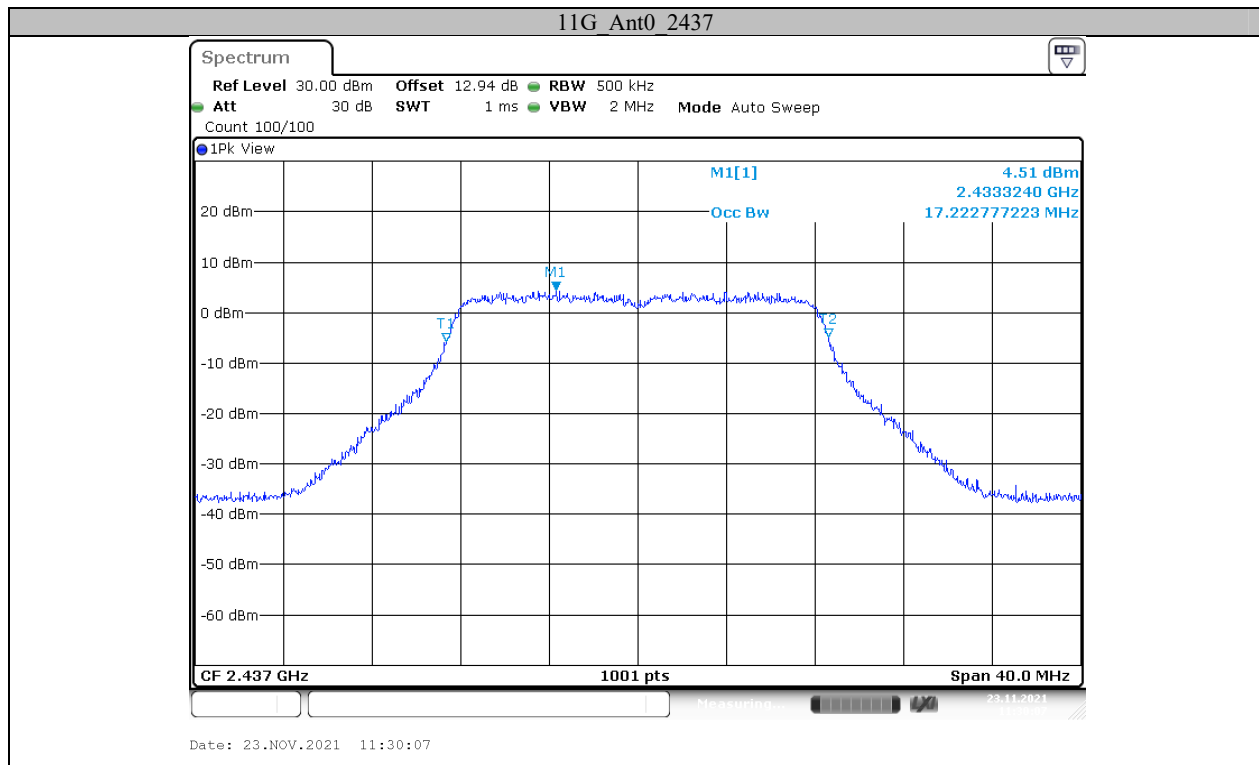

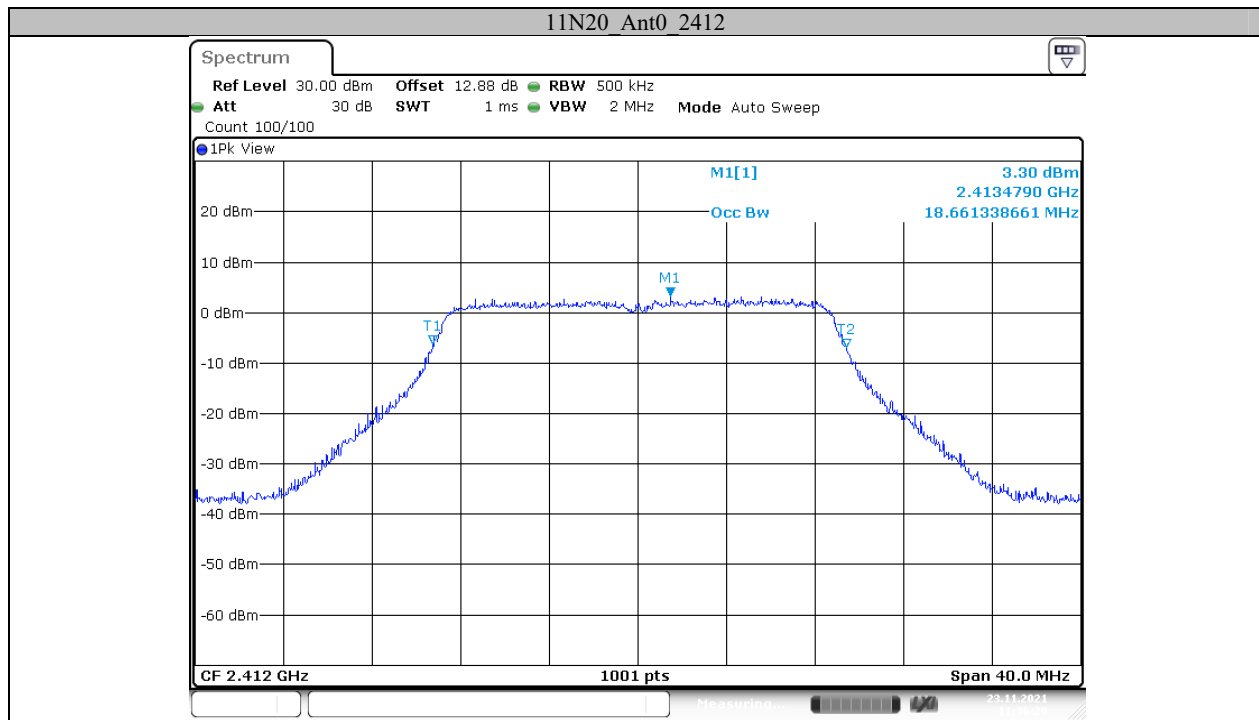

Date: 23.NOV.2021 11:36:29

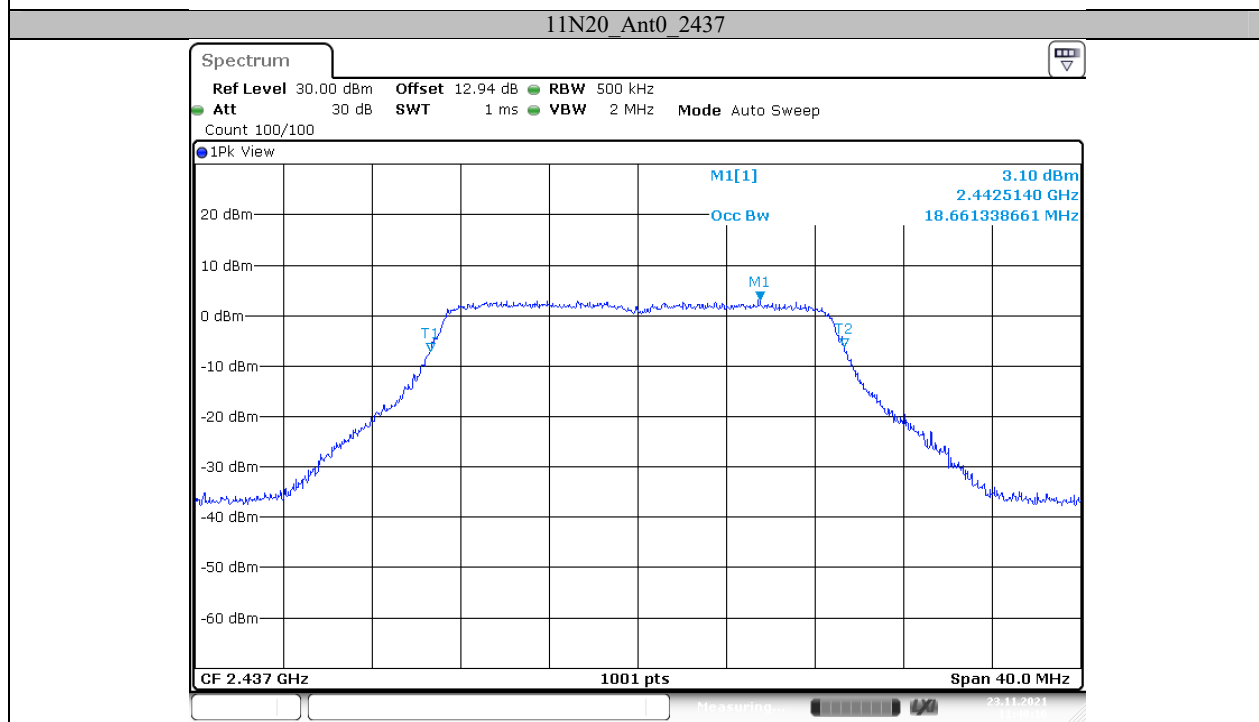

Date: 23.NOV.2021 11:40:16

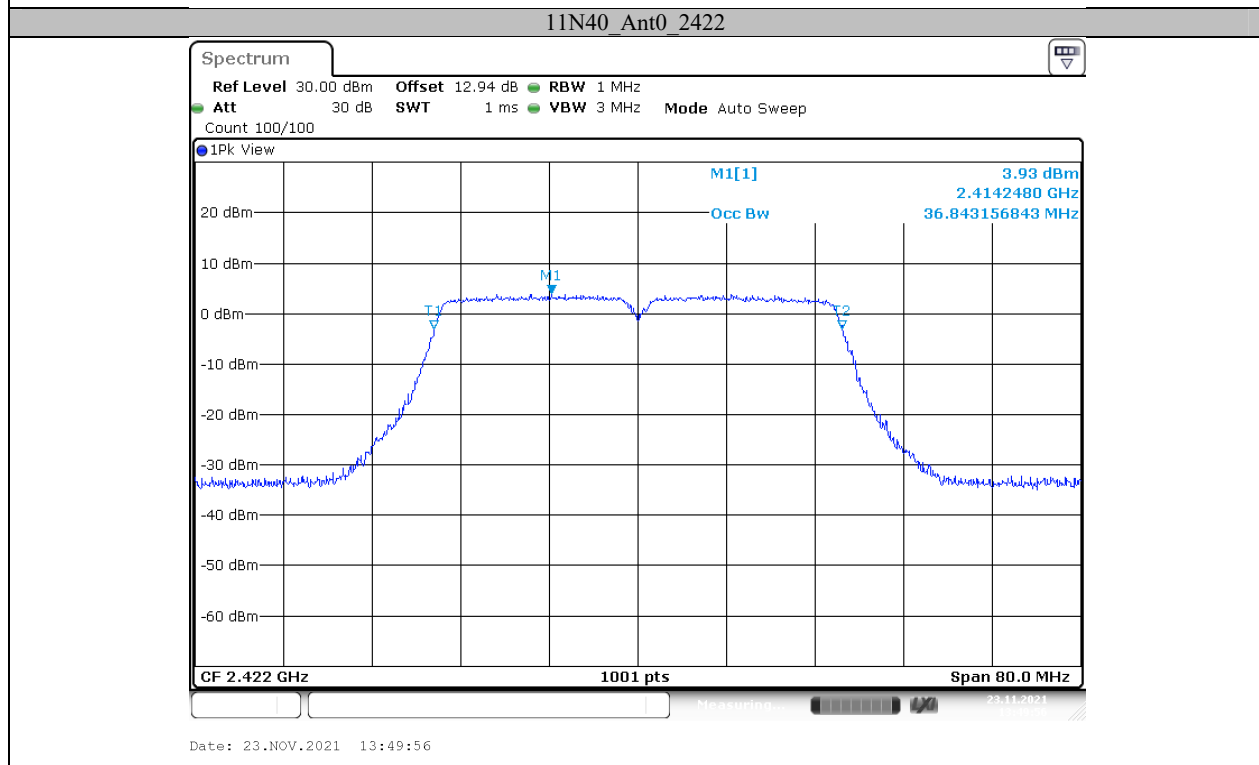
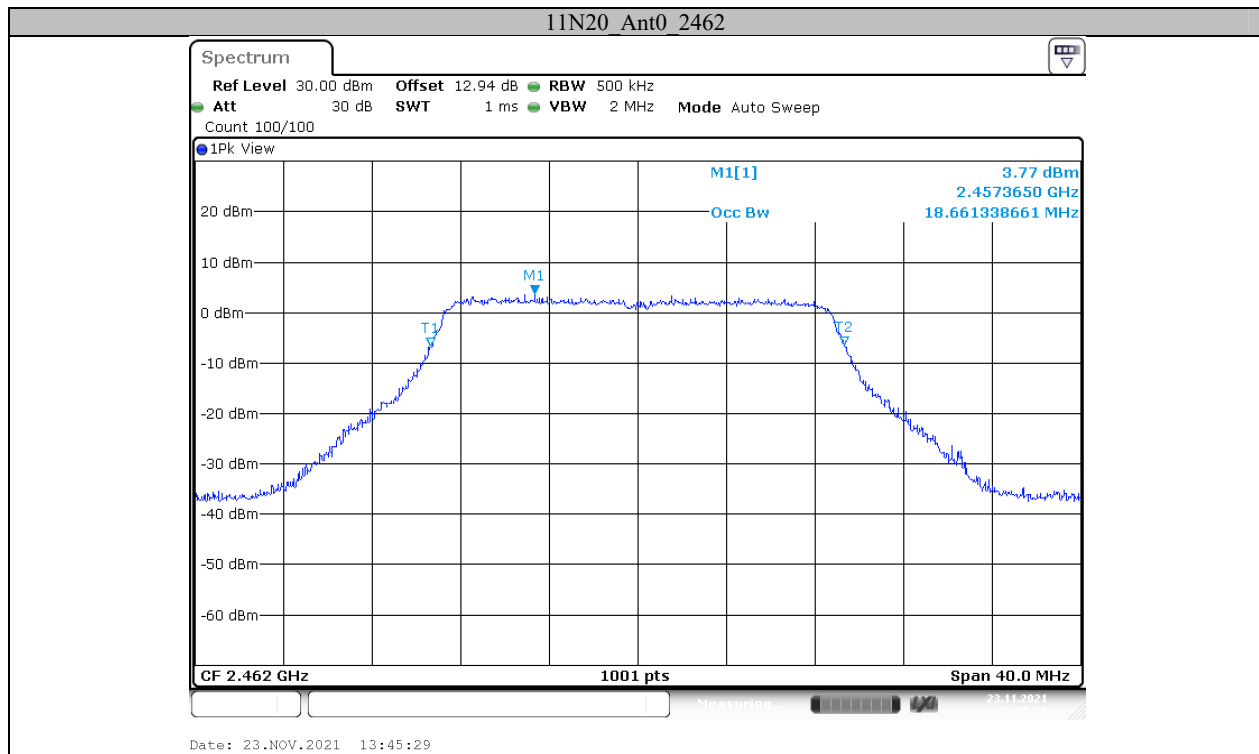

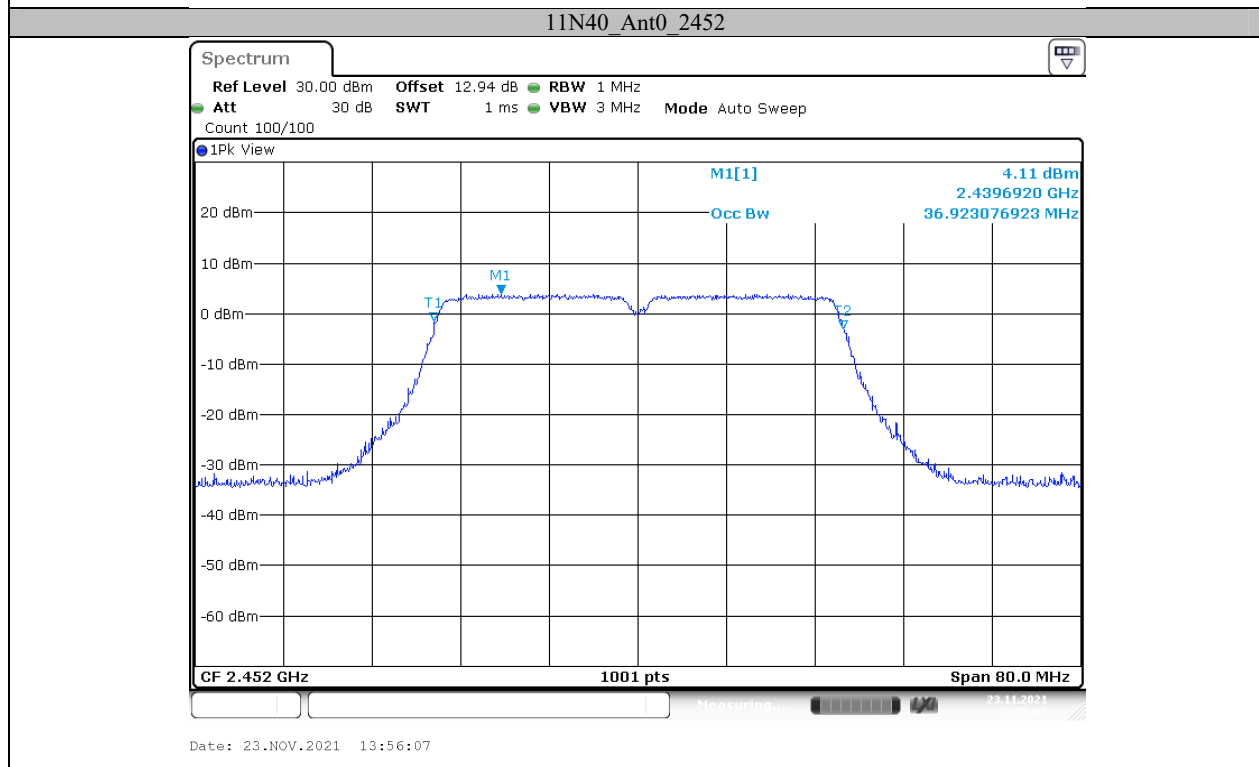
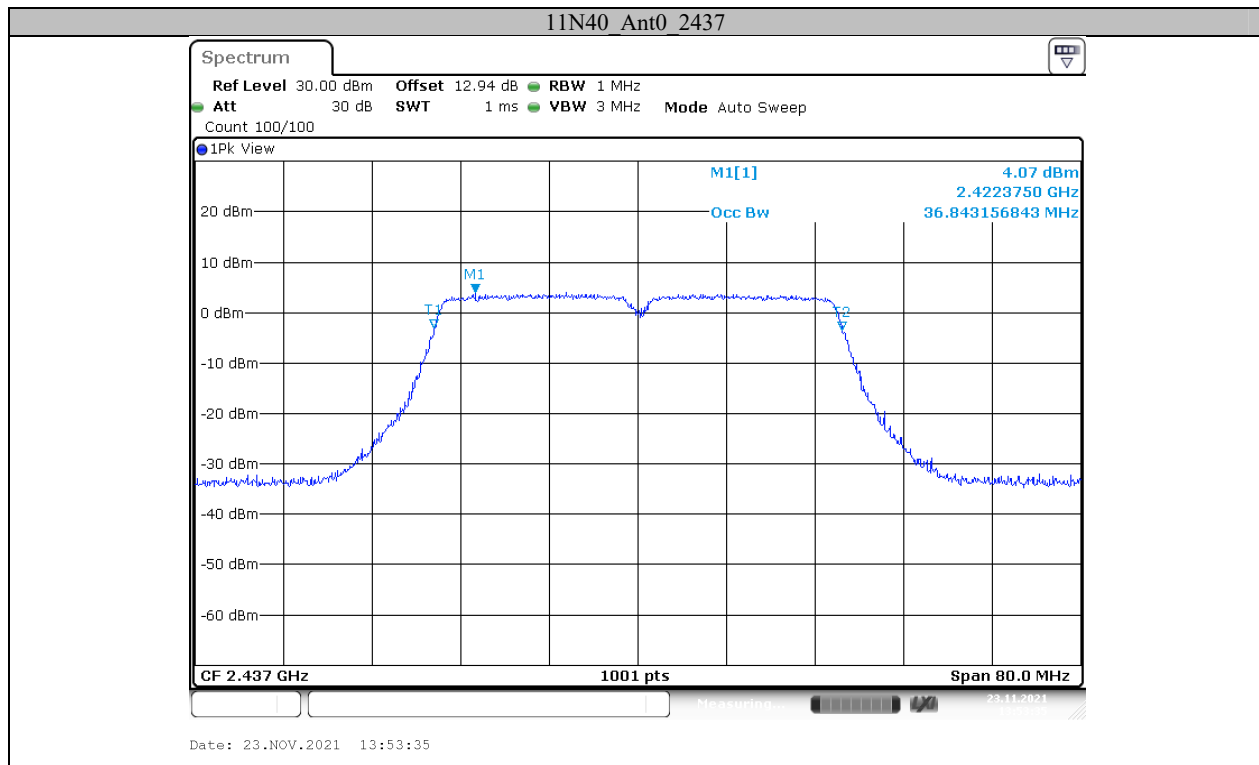

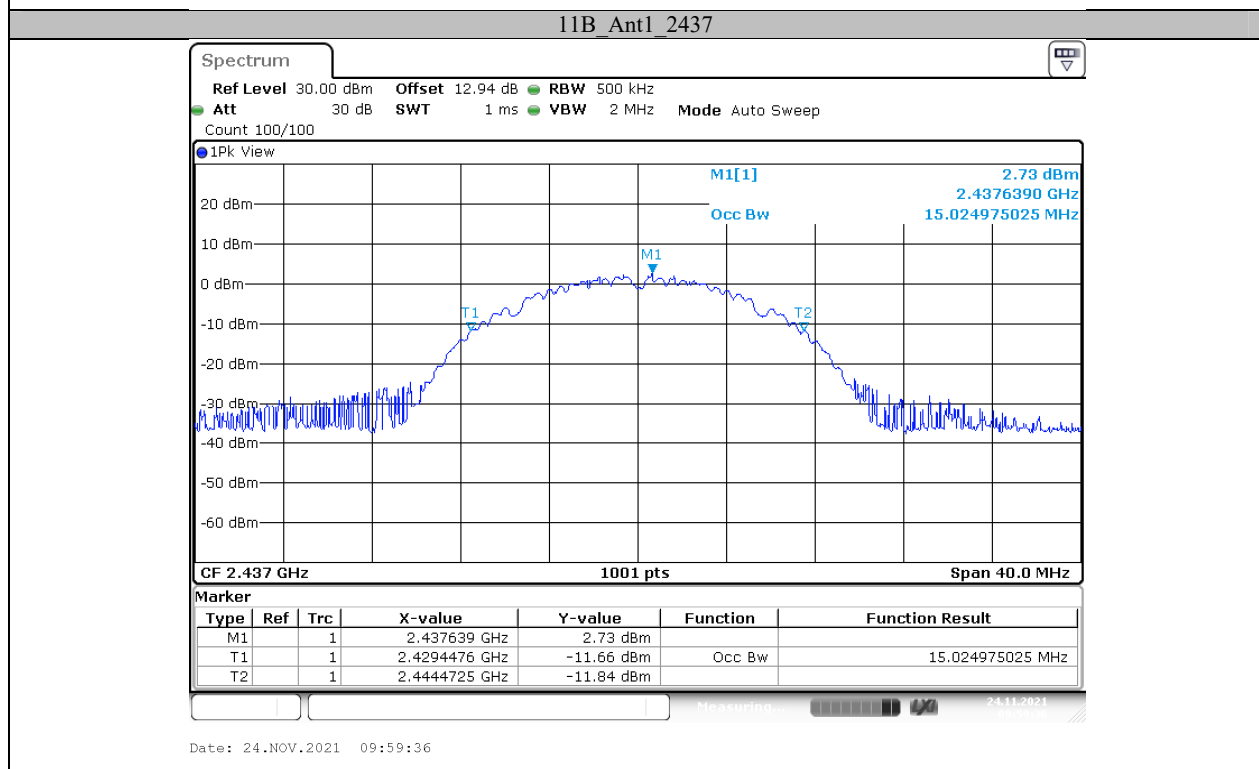
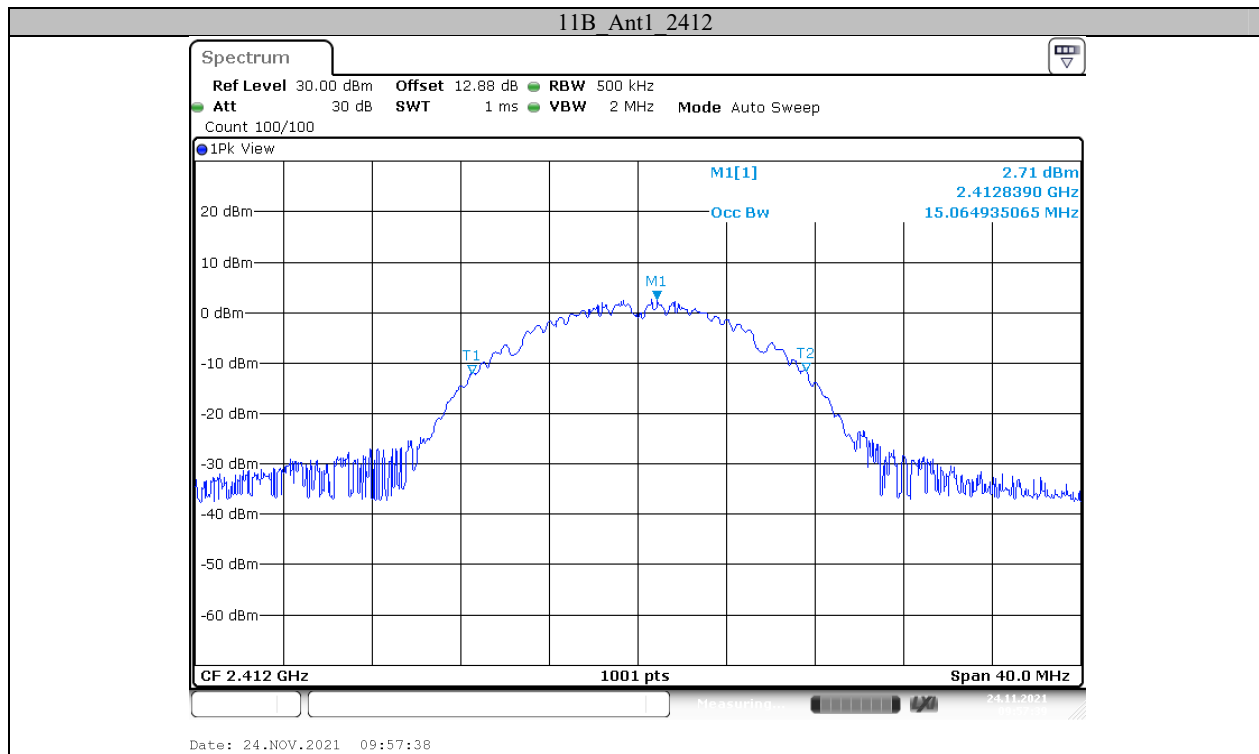

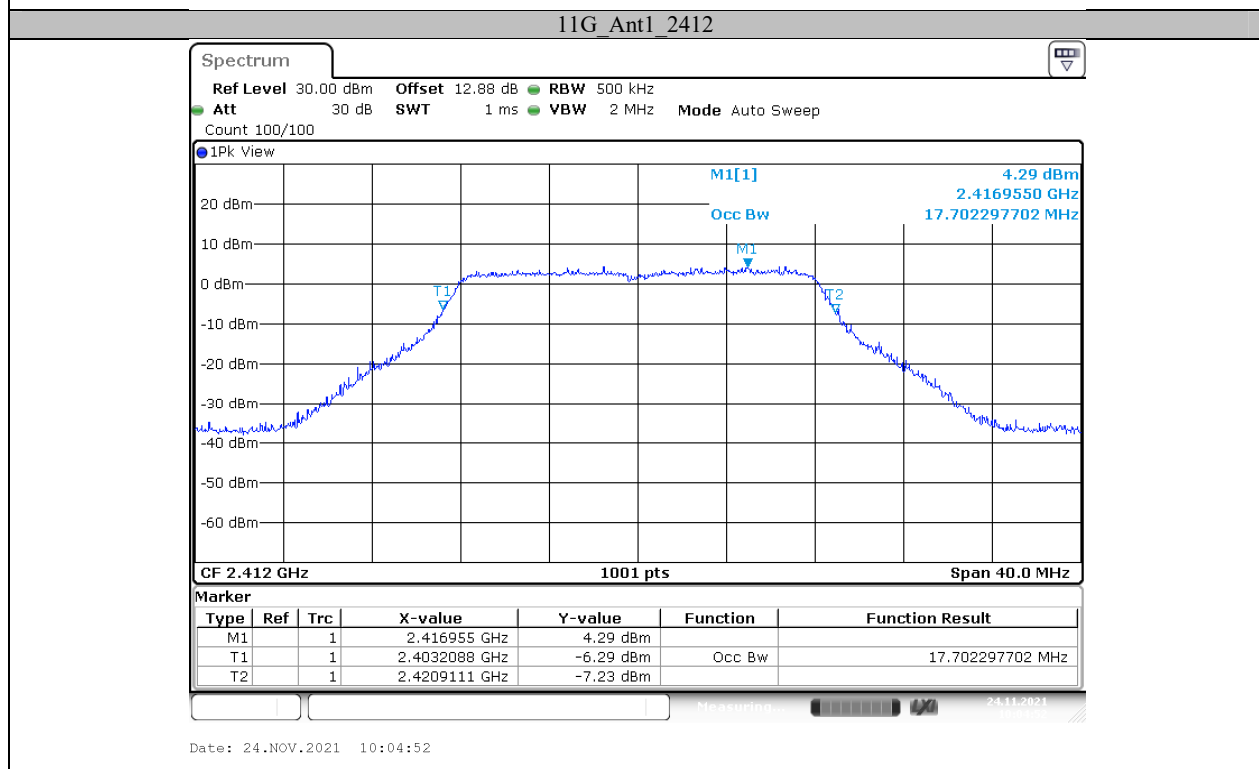
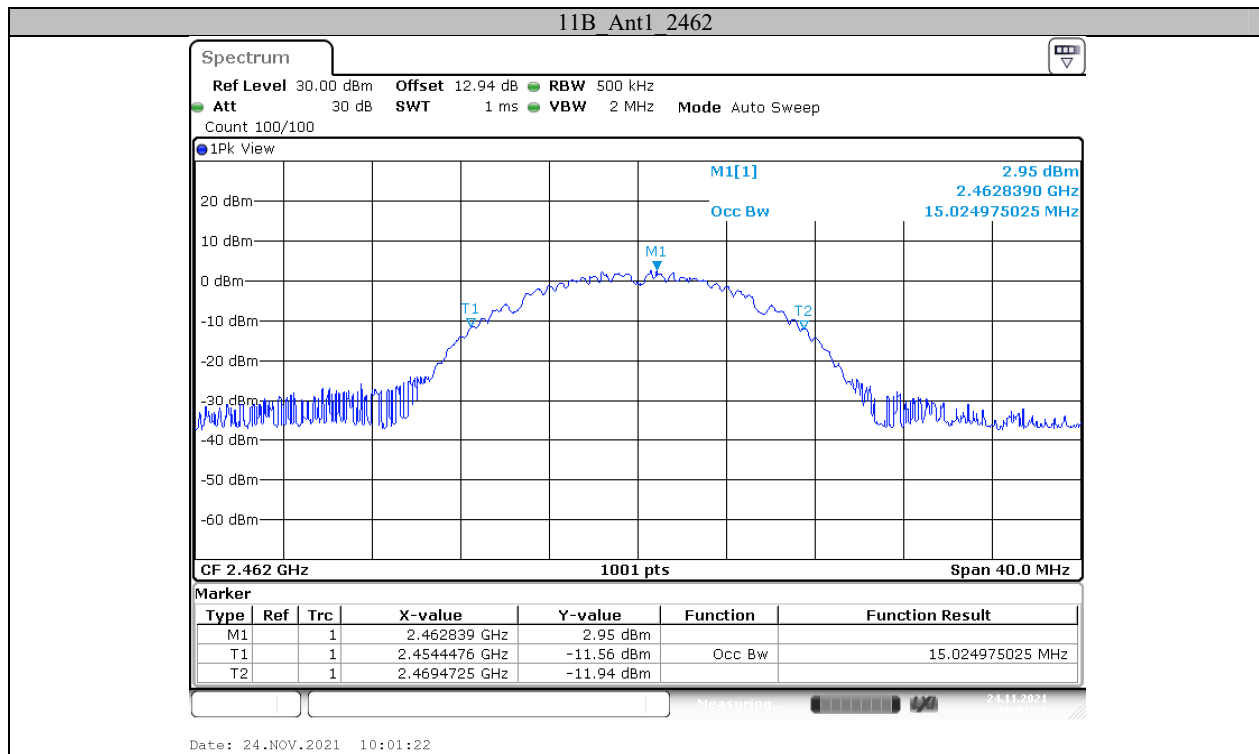

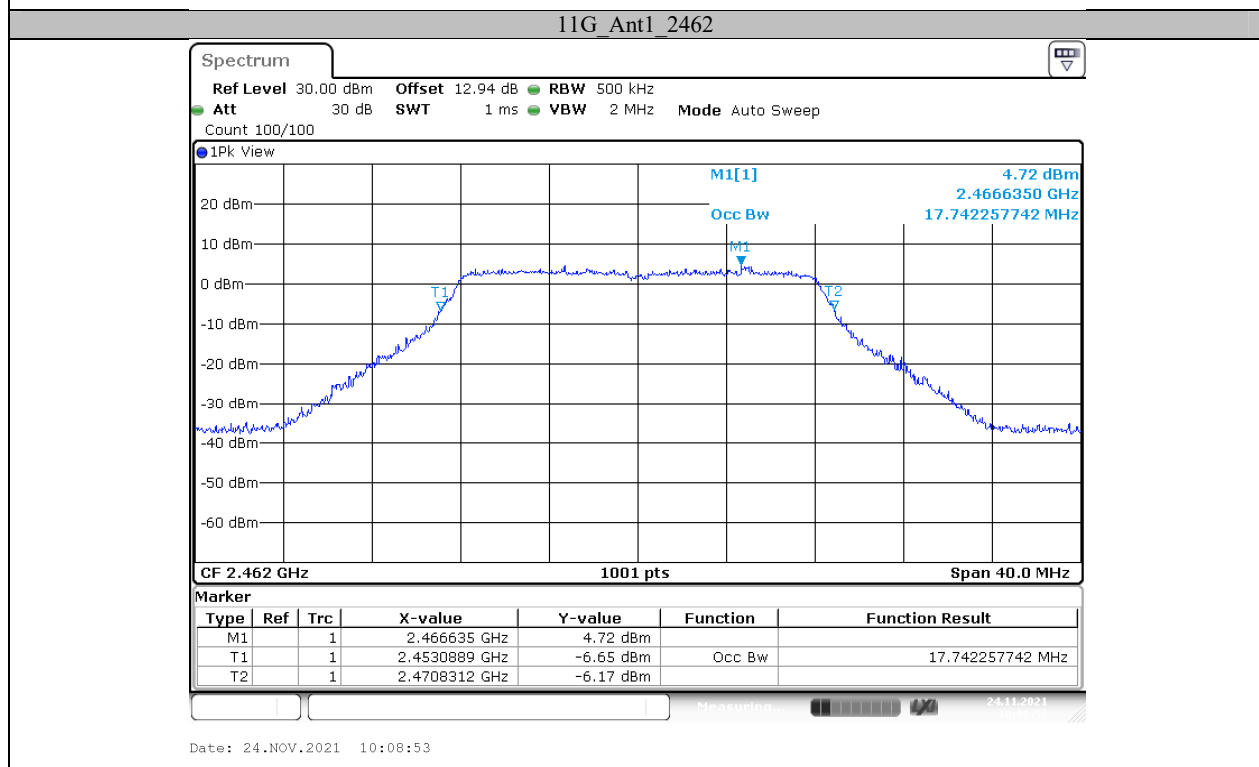
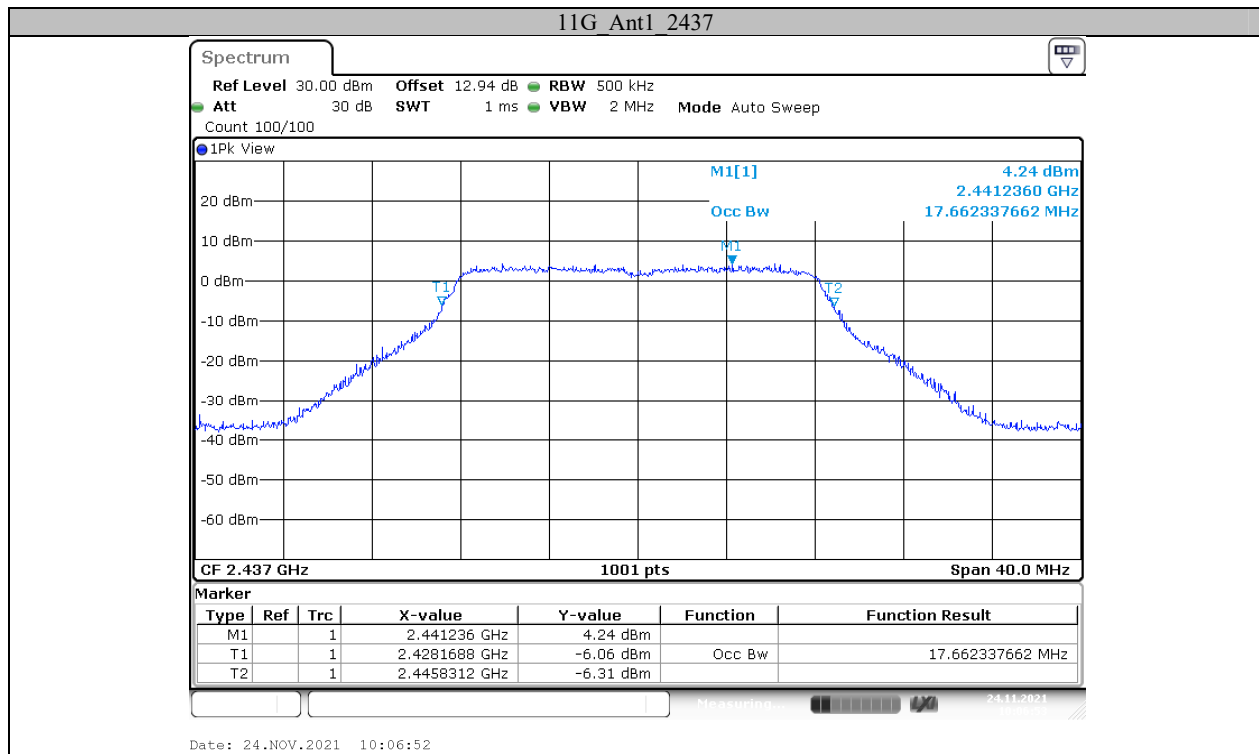

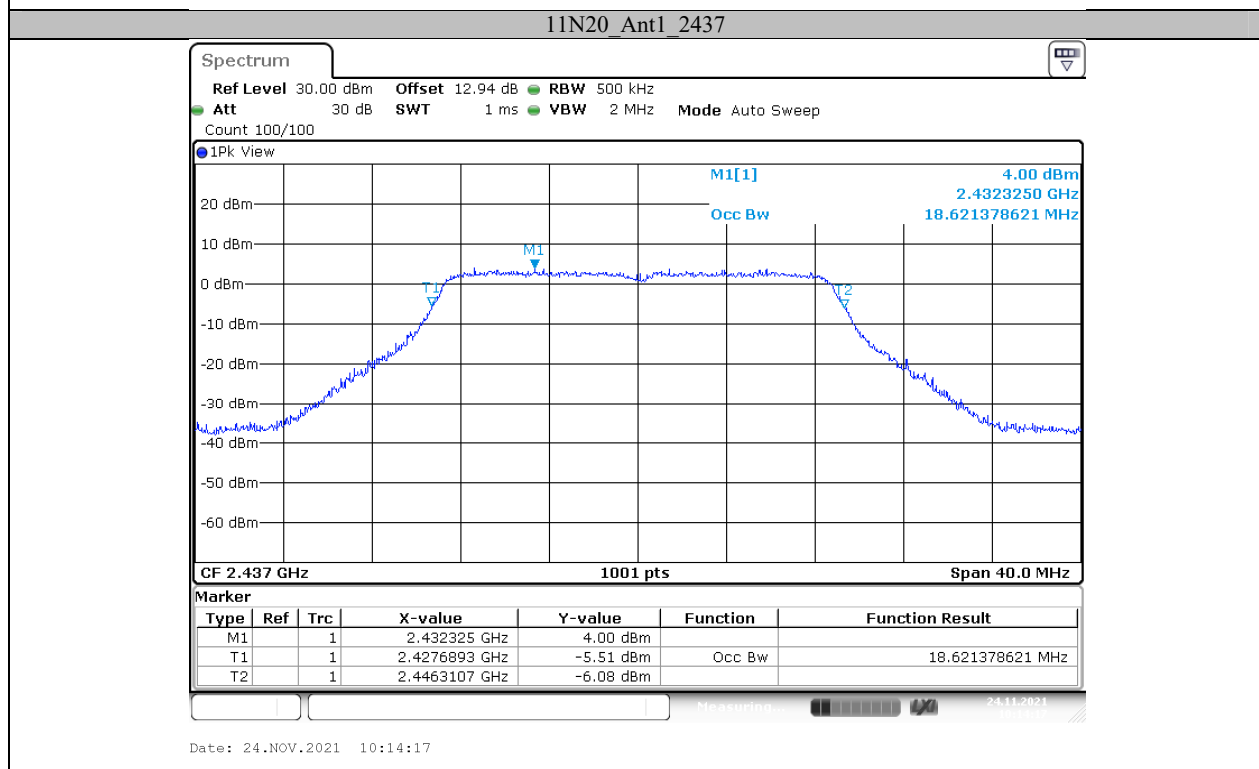
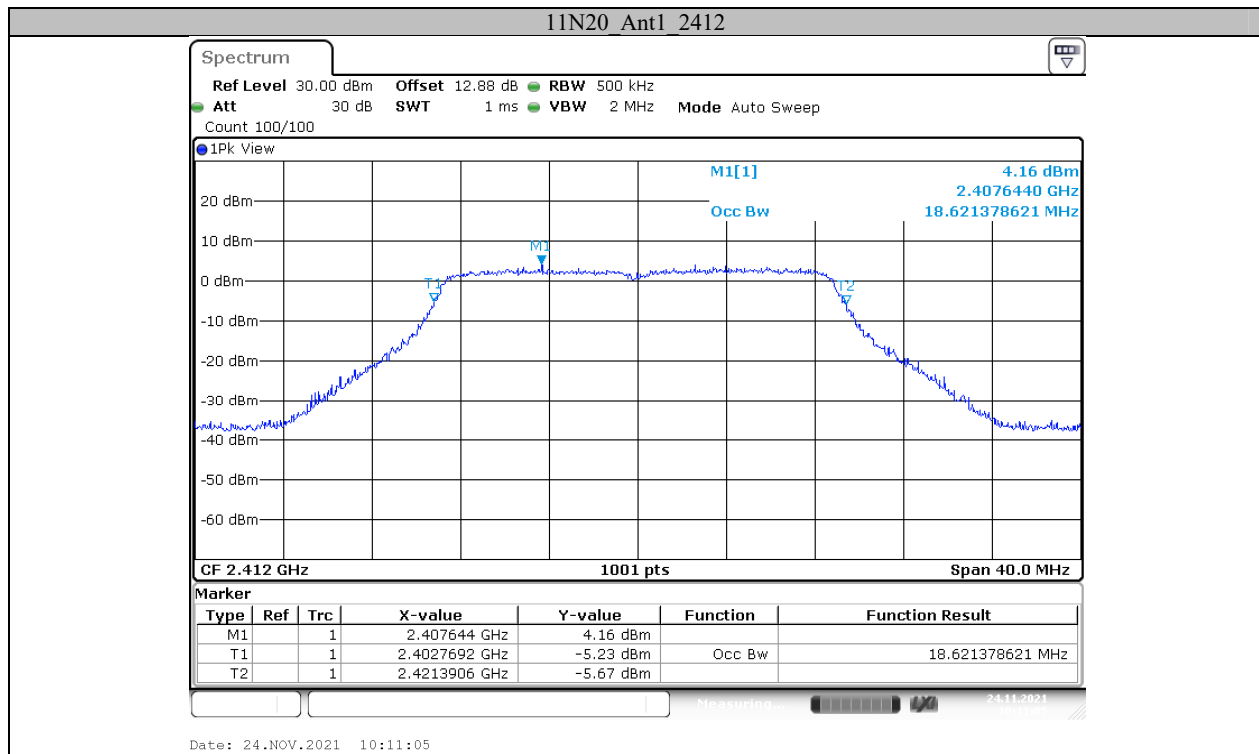

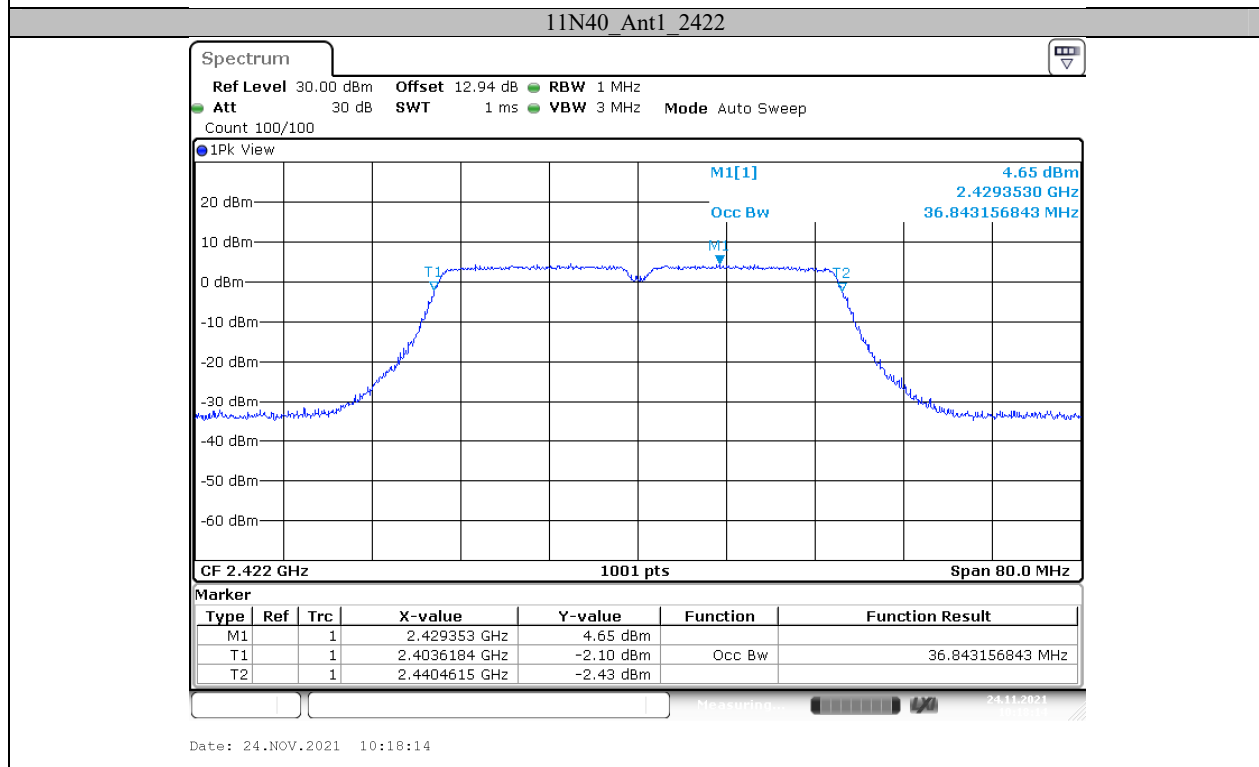
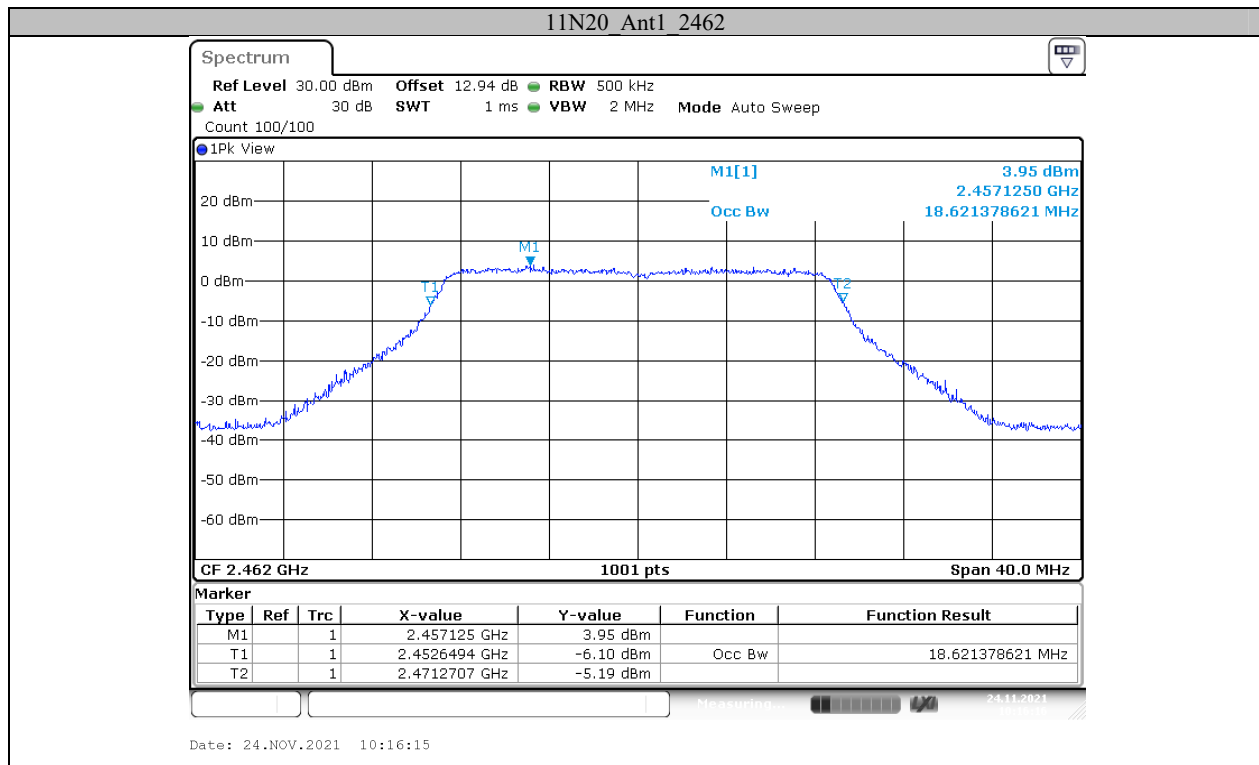

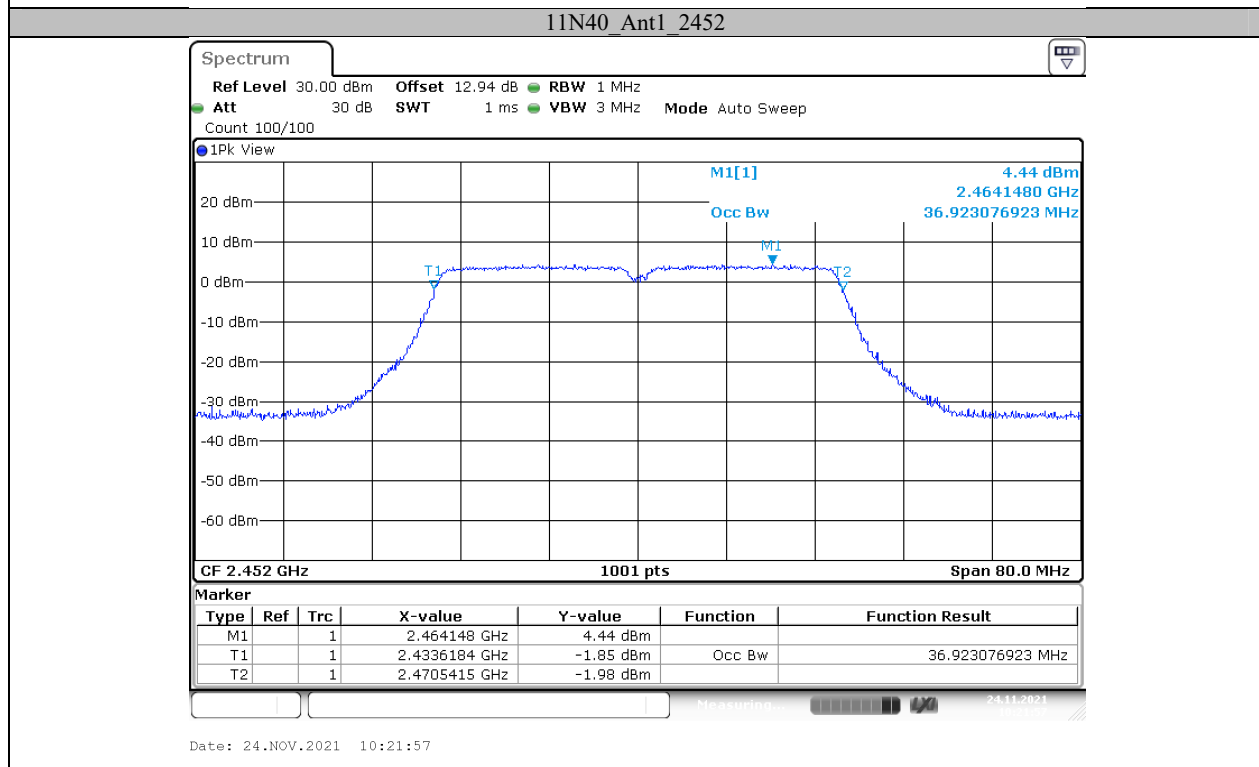
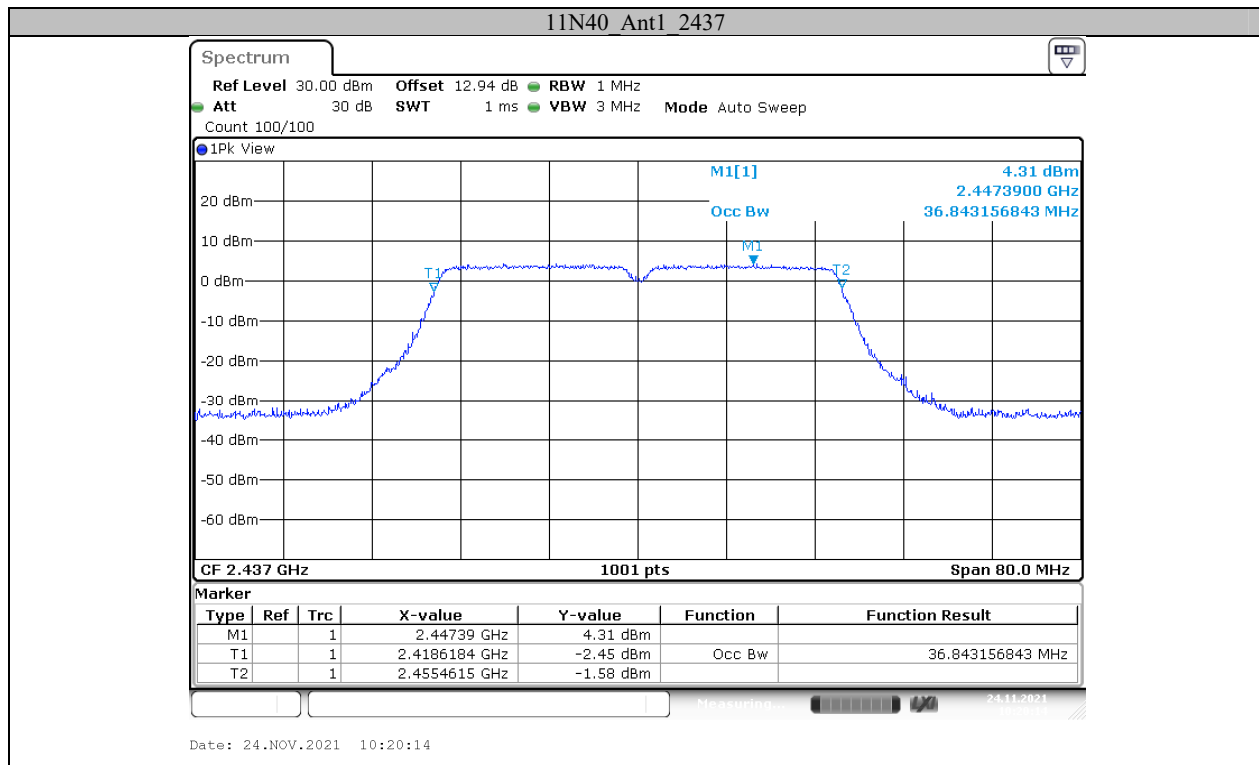

Test Graphs

Appendix C: Maximum Conducted Output Peak Power

Test Result

Test Mode	Channel [MHz]	Power Result [dBm]			Limit [dBm]	Verdict
		Ant 0	Ant 1	Total		
11B	2412	16.65	15.44	19.10	<=30	PASS
	2437	16.25	15.32	18.82	<=30	PASS
	2462	16.69	15.12	18.99	<=30	PASS
11G	2412	16.50	15.21	18.91	<=30	PASS
	2437	15.93	15.21	18.59	<=30	PASS
	2462	16.24	15.42	18.86	<=30	PASS
11N20	2412	16.21	15.20	18.74	<=30	PASS
	2437	16.49	15.30	18.95	<=30	PASS
	2462	16.08	15.14	18.65	<=30	PASS
11N40	2422	16.52	15.42	19.01	<=30	PASS
	2437	16.23	15.42	18.85	<=30	PASS
	2452	15.84	15.20	18.54	<=30	PASS

Note 1: The maximum antenna gain is 2.68dBi. The device employed Cyclic Delay Diversity (CDD) for 802.11 MIMO transmitting, per KDB 662911 D01 Multiple Transmitter Output v02r01, for power measurements on IEEE 802.11 devices:

Array Gain = 0dB (i.e., no array gain) For $N_{ANT} \leq 4$;

So: Directional gain=2.68dBi <6dBi

Appendix D: Power spectral density**Test Result**

TestMode	Channel[MHz]	Result[dBm/3kHz]			Limit[dBm/3kHz]	Verdict
		Ant 0	Ant 1	Total		
11B	2412	-12.7	-14.83	-10.63	<=8	PASS
	2437	-12.59	-14.64	-10.48	<=8	PASS
	2462	-12.7	-14.51	-10.5	<=8	PASS
11G	2412	-14.82	-16.11	-12.41	<=8	PASS
	2437	-13.87	-15.85	-11.74	<=8	PASS
	2462	-14.19	-16.08	-12.02	<=8	PASS
11N20	2412	-14.52	-16.26	-12.29	<=8	PASS
	2437	-14.61	-16.75	-12.54	<=8	PASS
	2462	-14.33	-16.15	-12.14	<=8	PASS
11N40	2422	-17.37	-18.66	-14.96	<=8	PASS
	2437	-17.78	-18.55	-15.14	<=8	PASS
	2452	-16.39	-19.65	-14.71	<=8	PASS

Note 1: The maximum antenna gain is 2.68 dBi. The device employed Cyclic Delay Diversity (CDD) for 802.11 MIMO transmitting, per KDB 662911 D01 Multiple Transmitter Output v02r01, for power spectral density (PSD) measurements on the devices

$$\text{Array Gain} = 10 \log(N_{\text{ANT}}/N_{\text{ss}})\text{dB}$$

$$\text{So: Directional gain} = G_{\text{ANT}} + \text{Array Gain} = 2.68 + 10 * \log(2/1) = 5.69\text{dBi} < 6\text{dBi}$$

Test Graphs

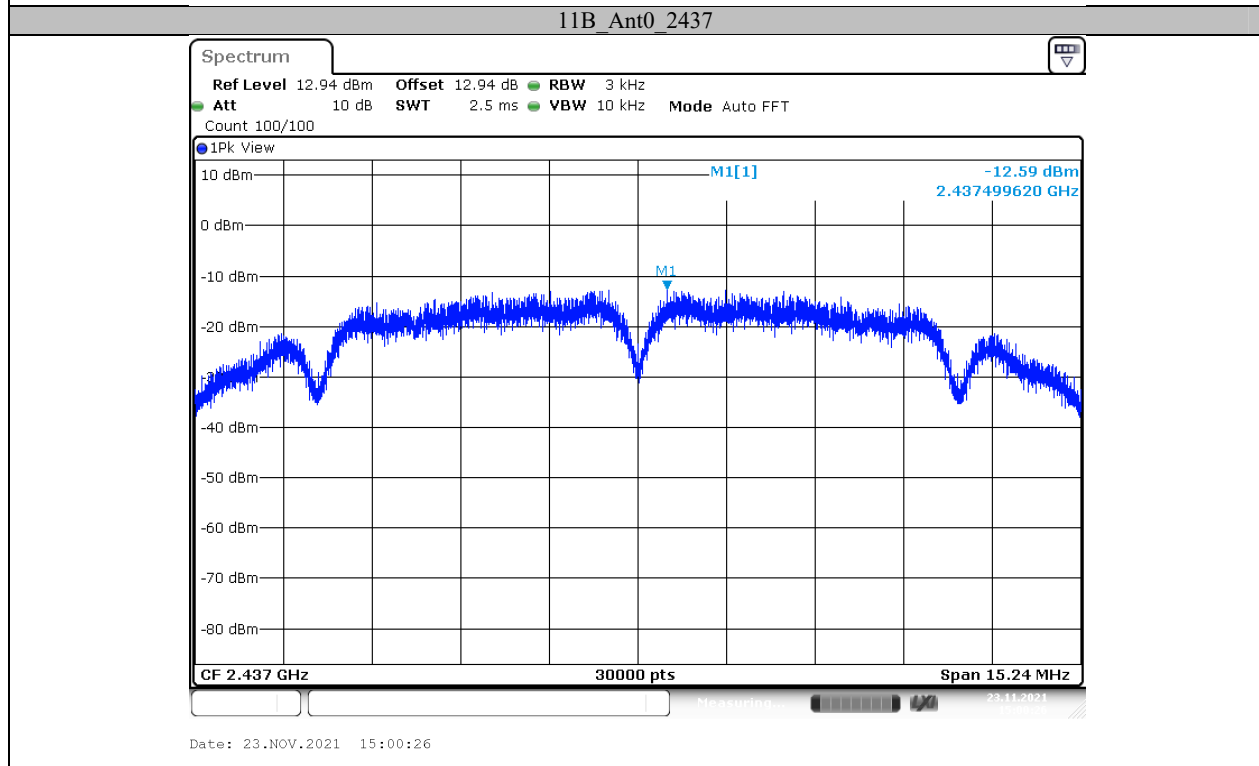
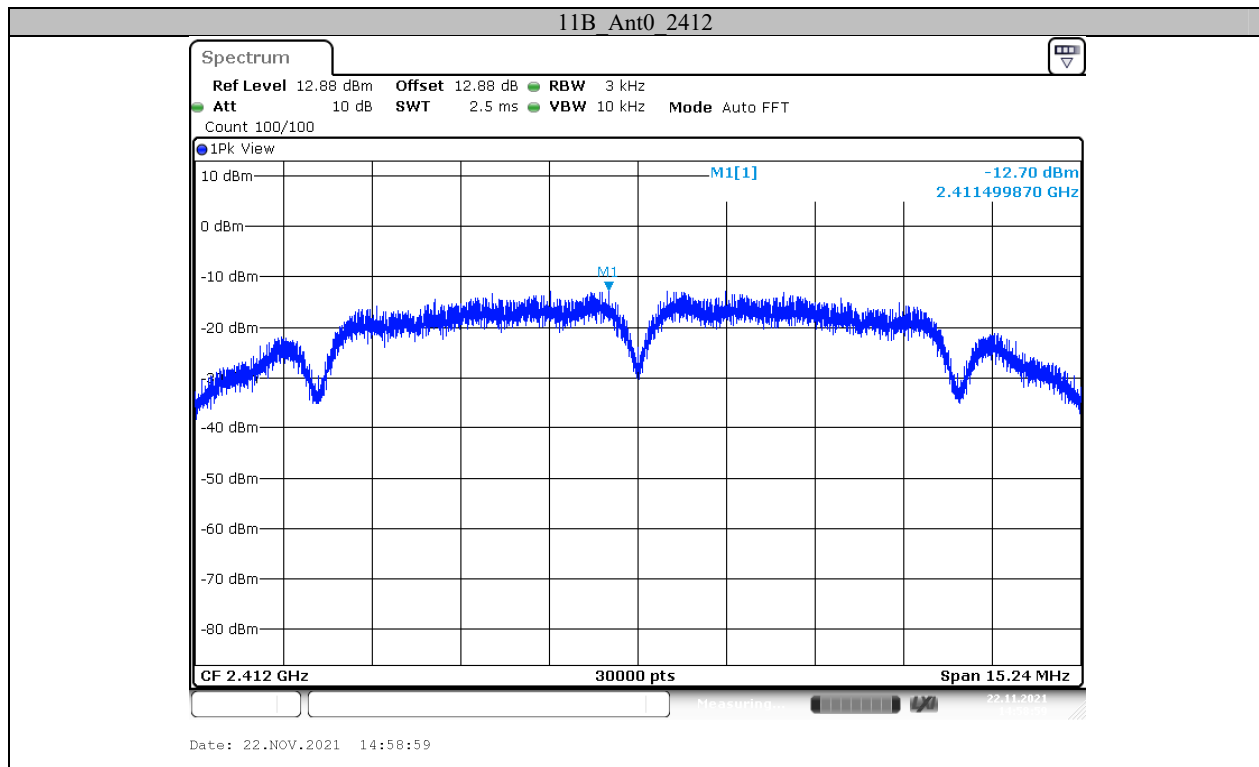

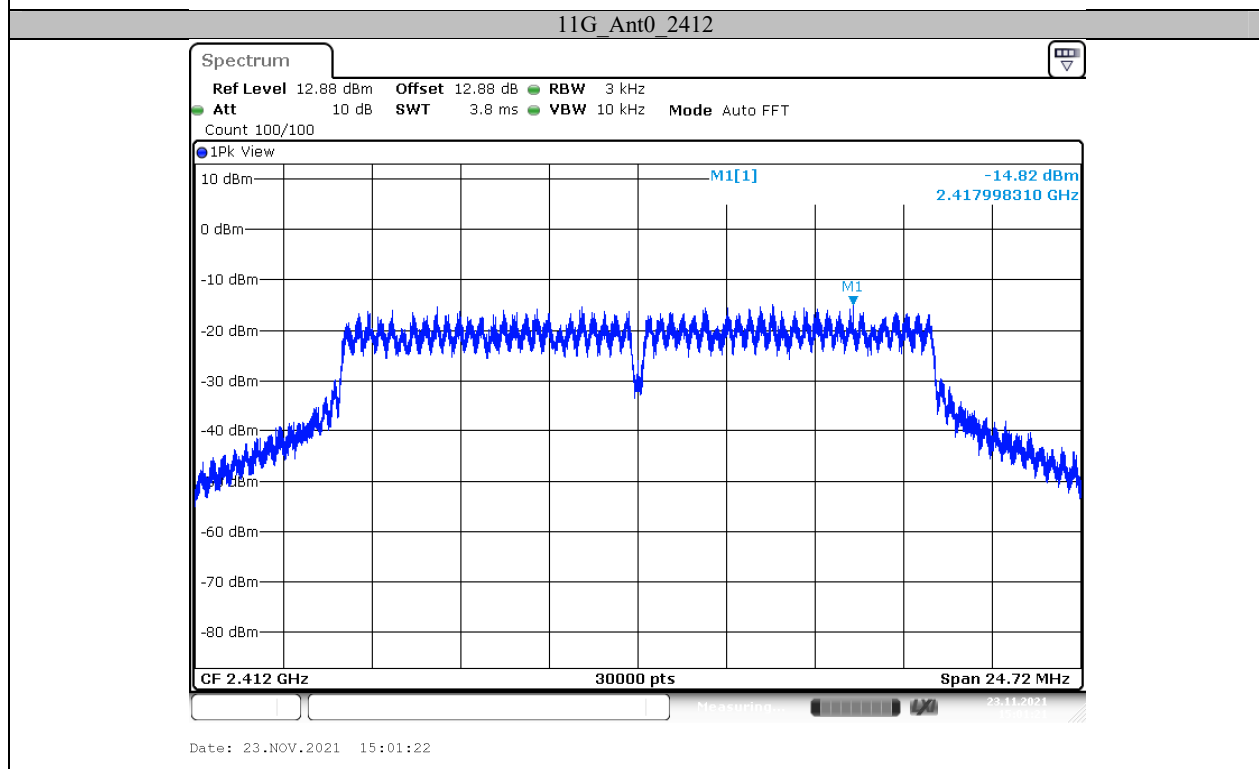
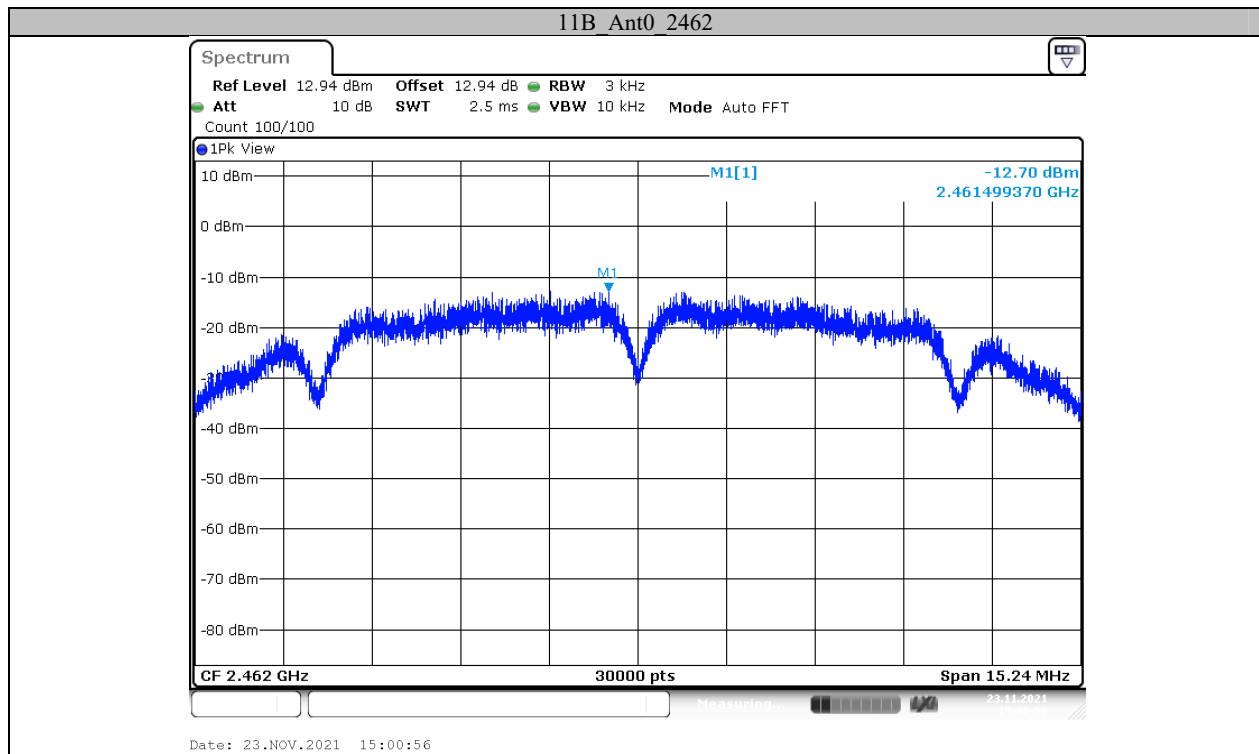

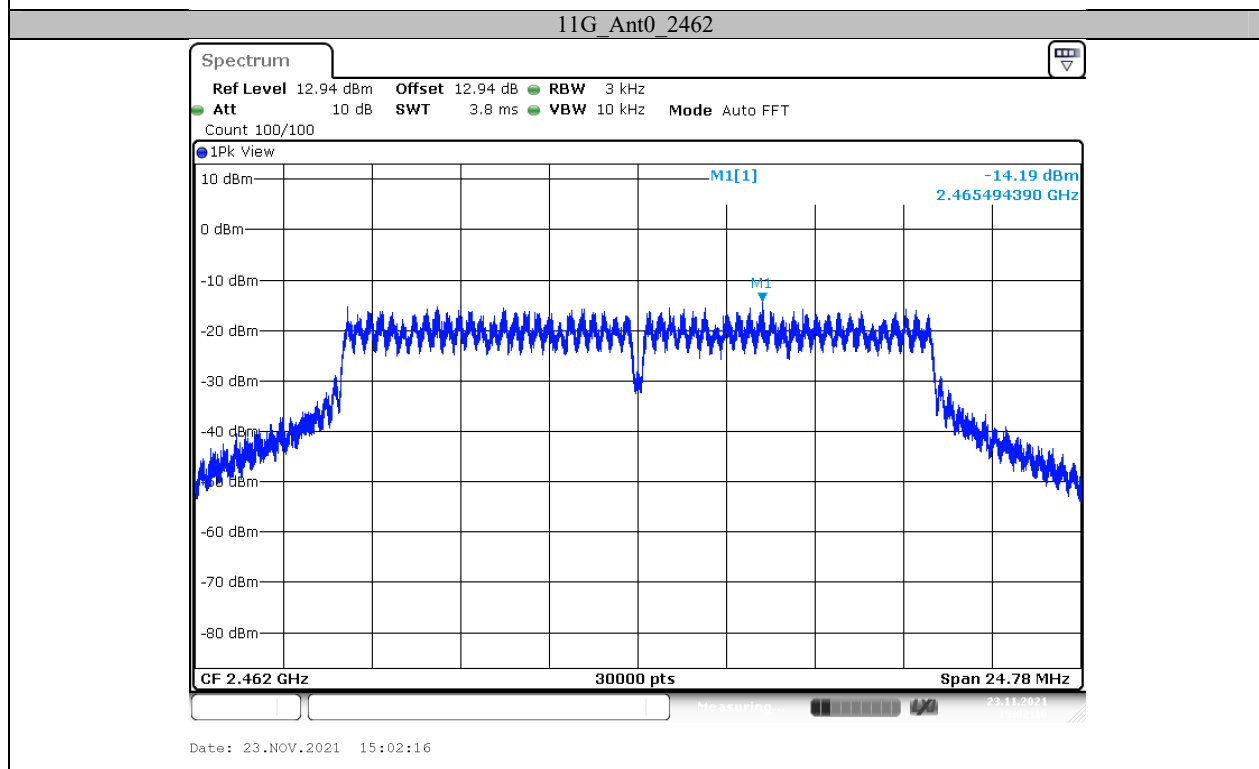
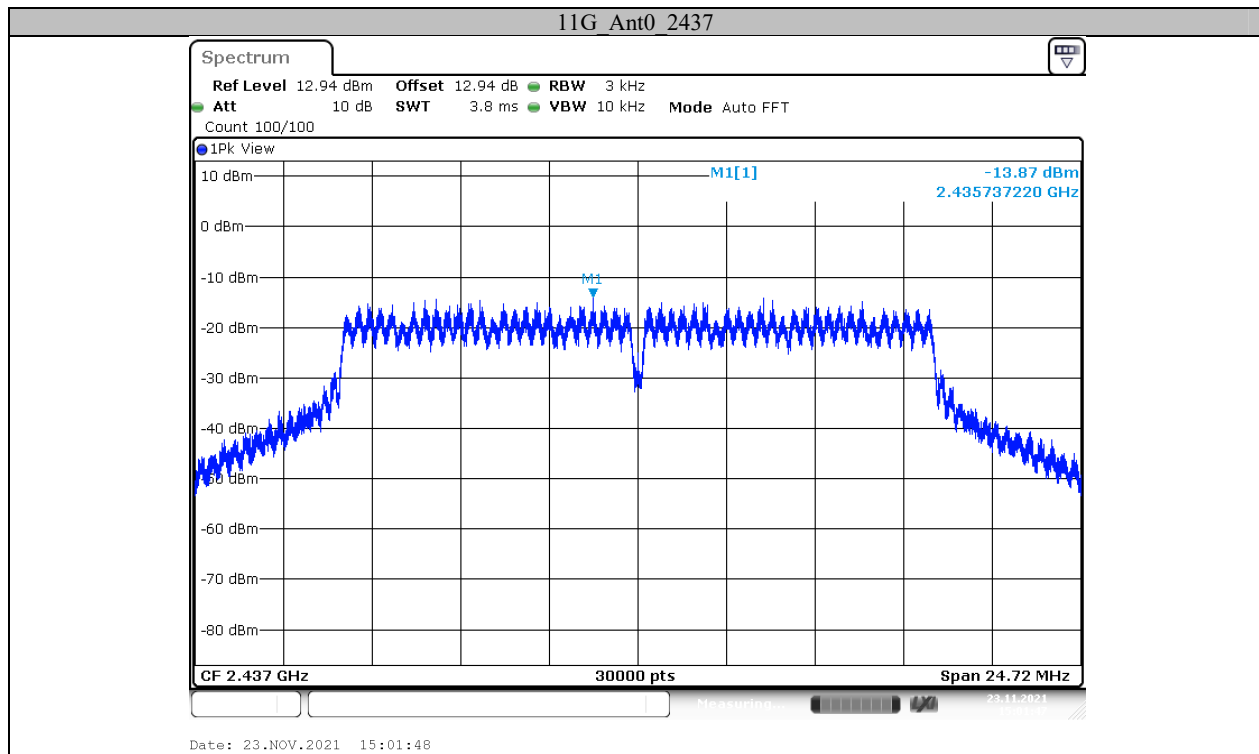

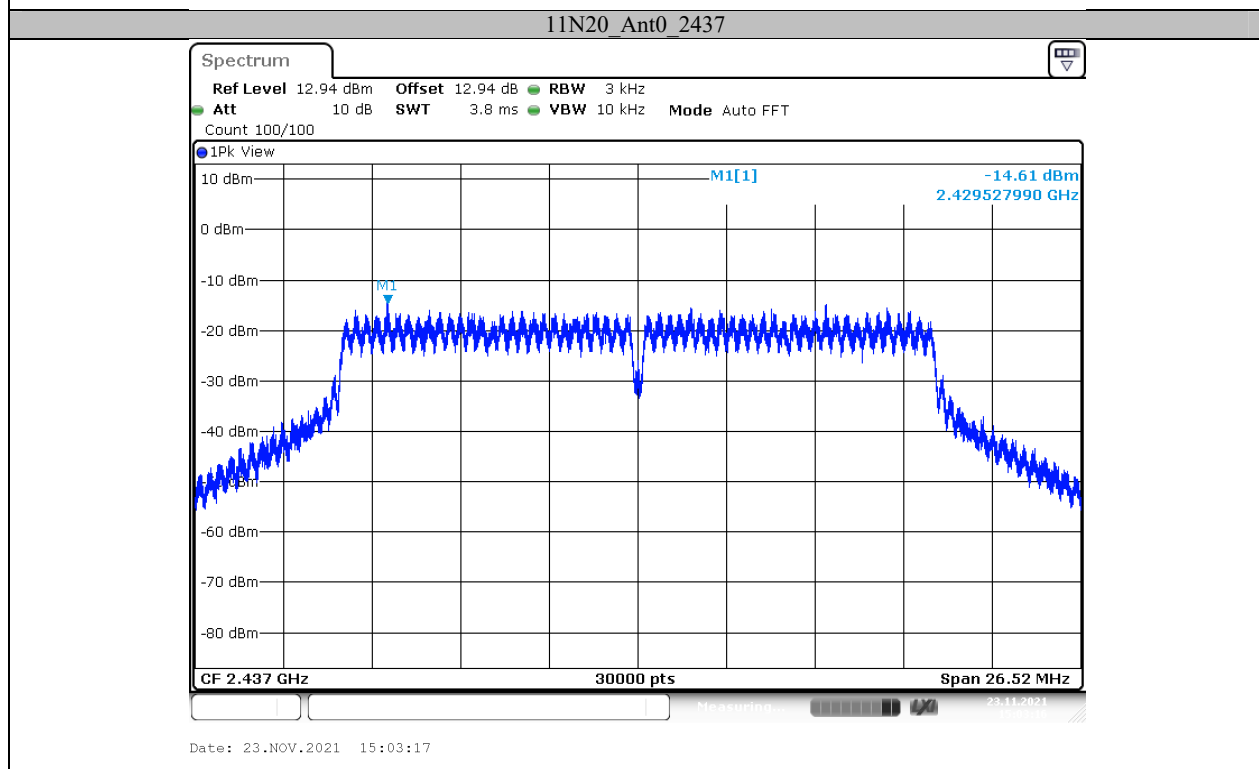
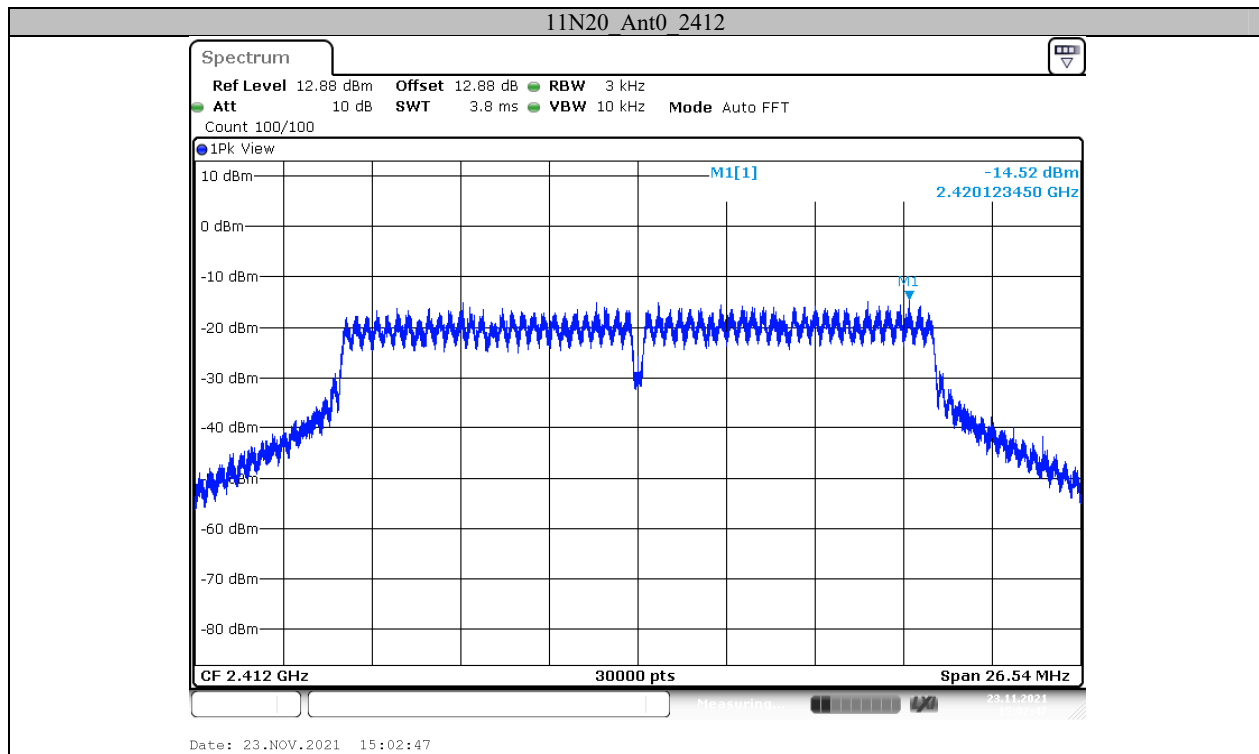

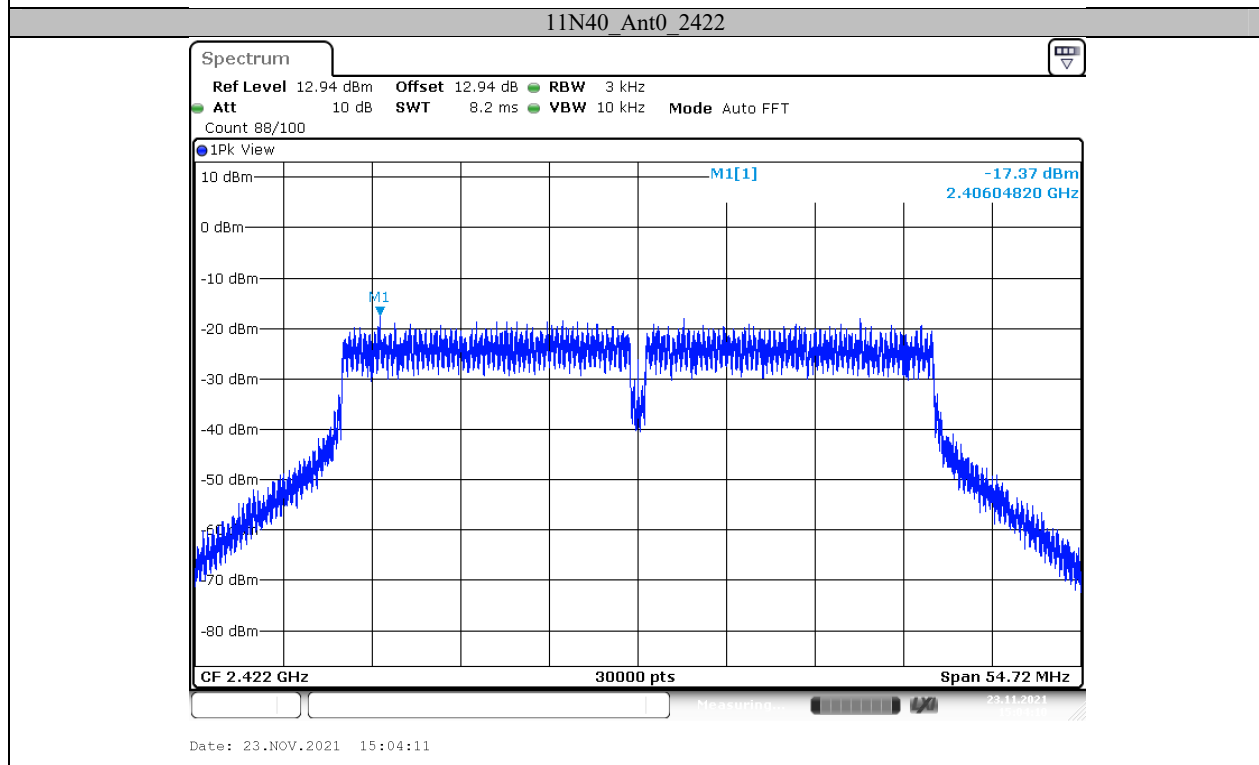
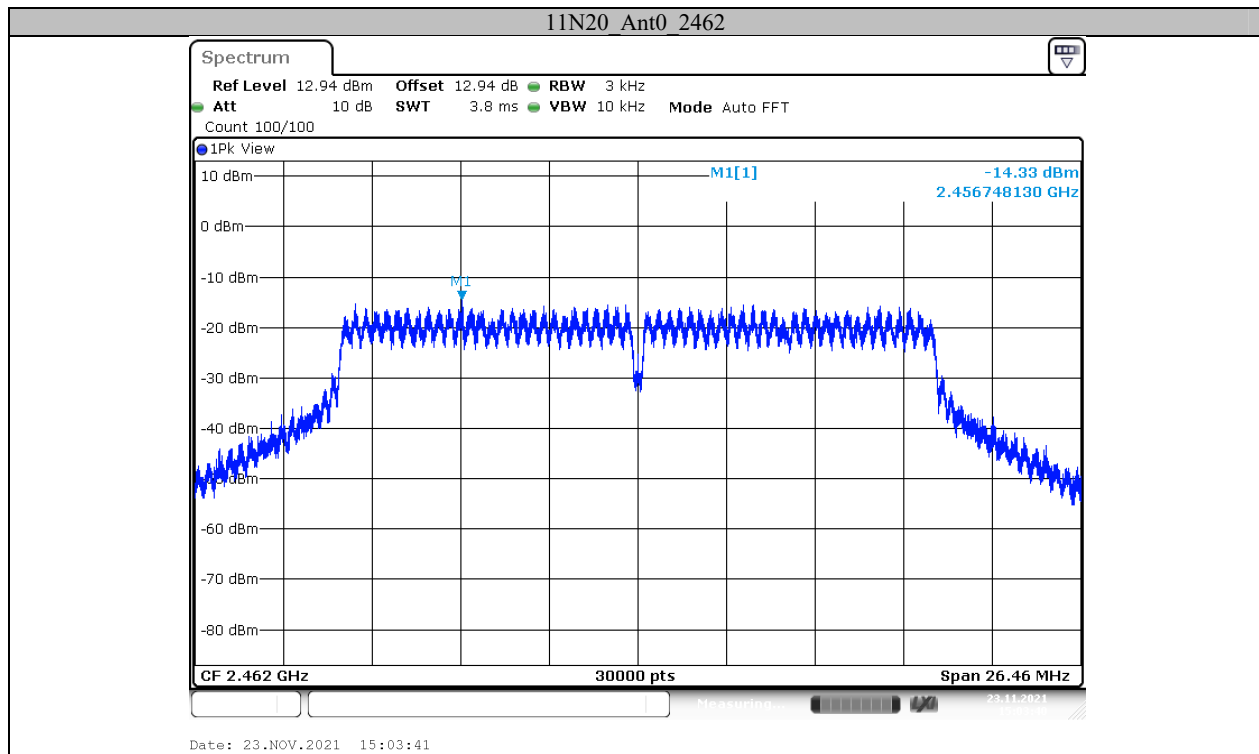

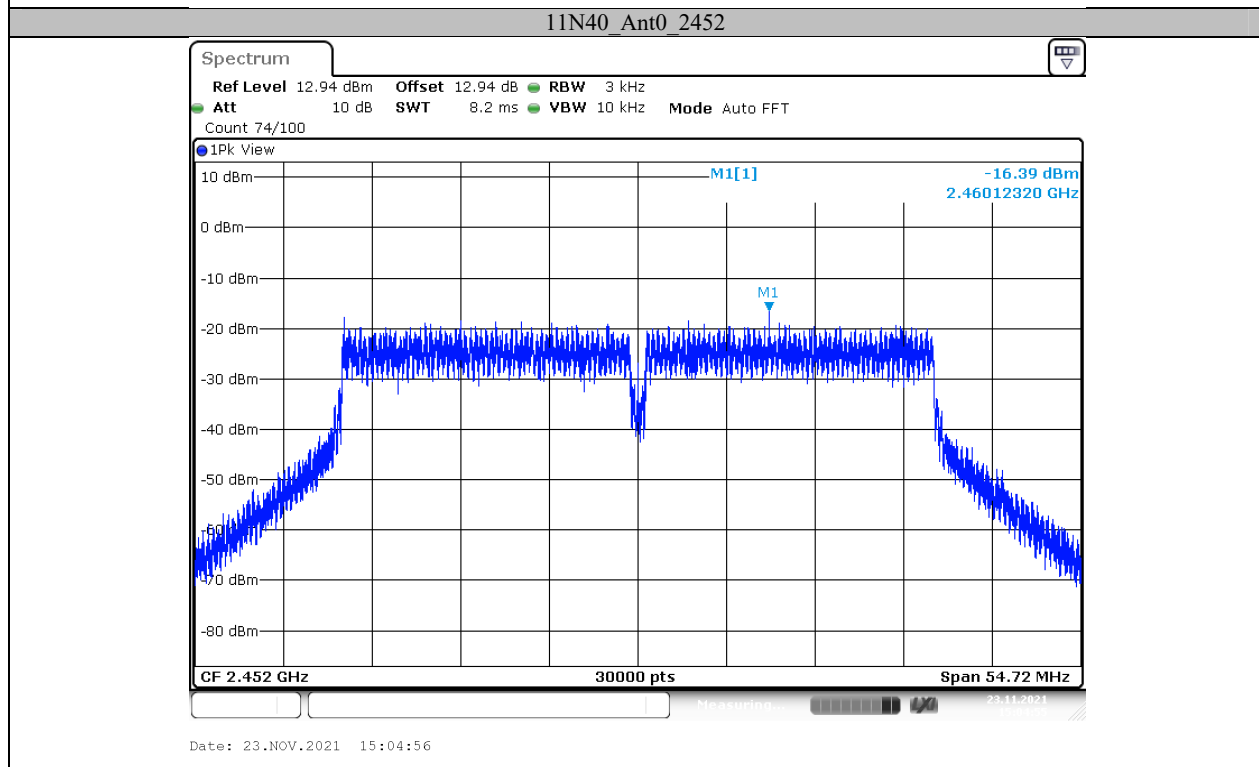
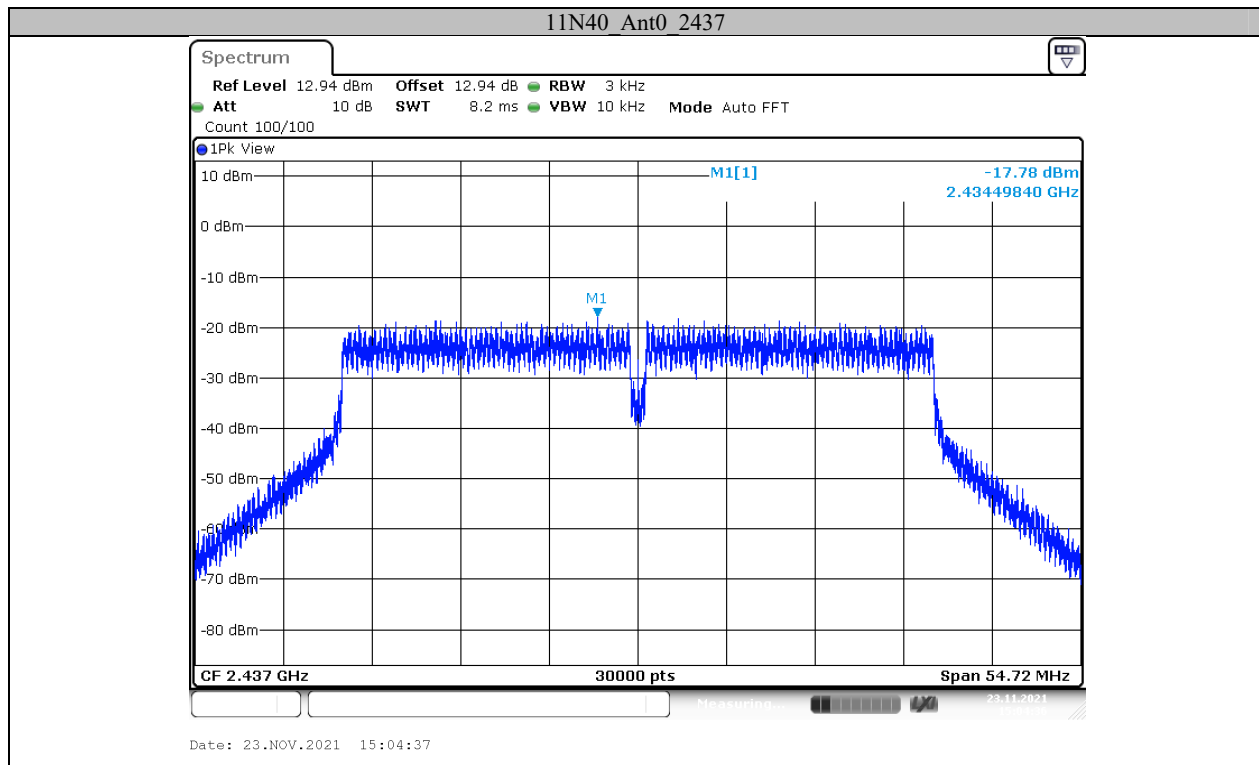

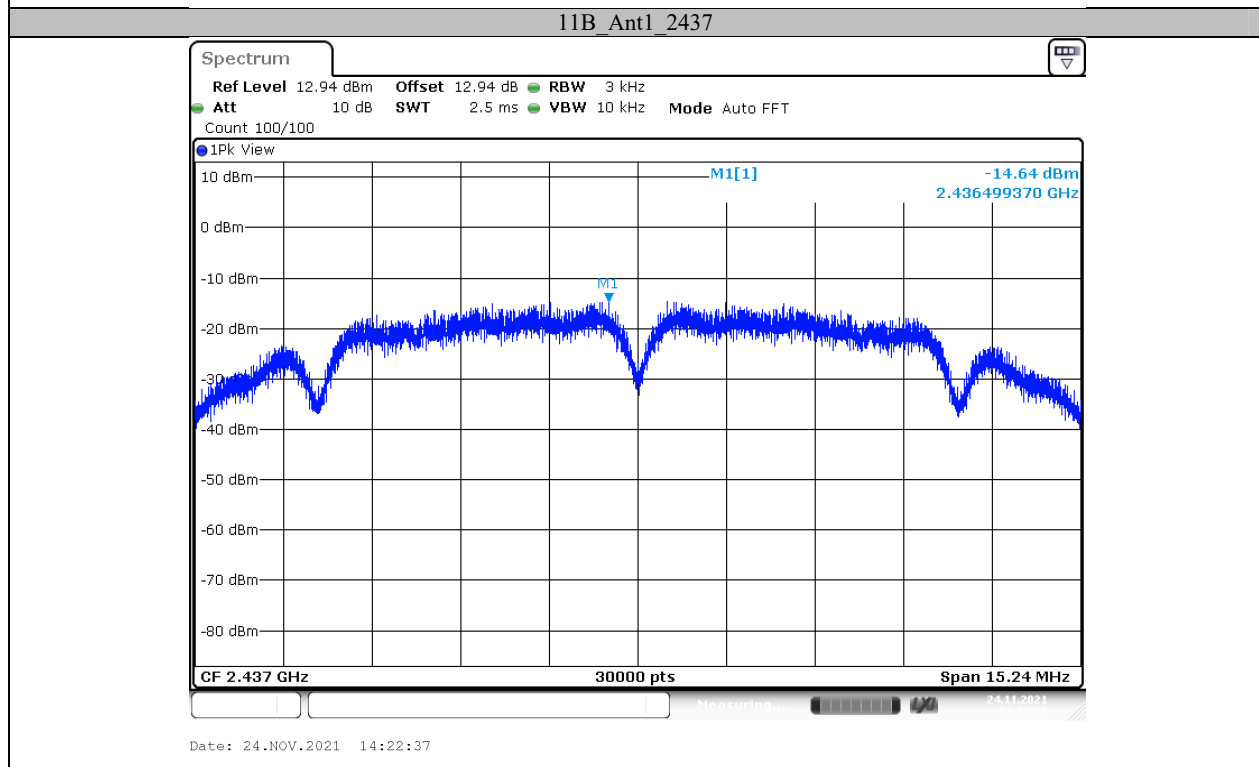
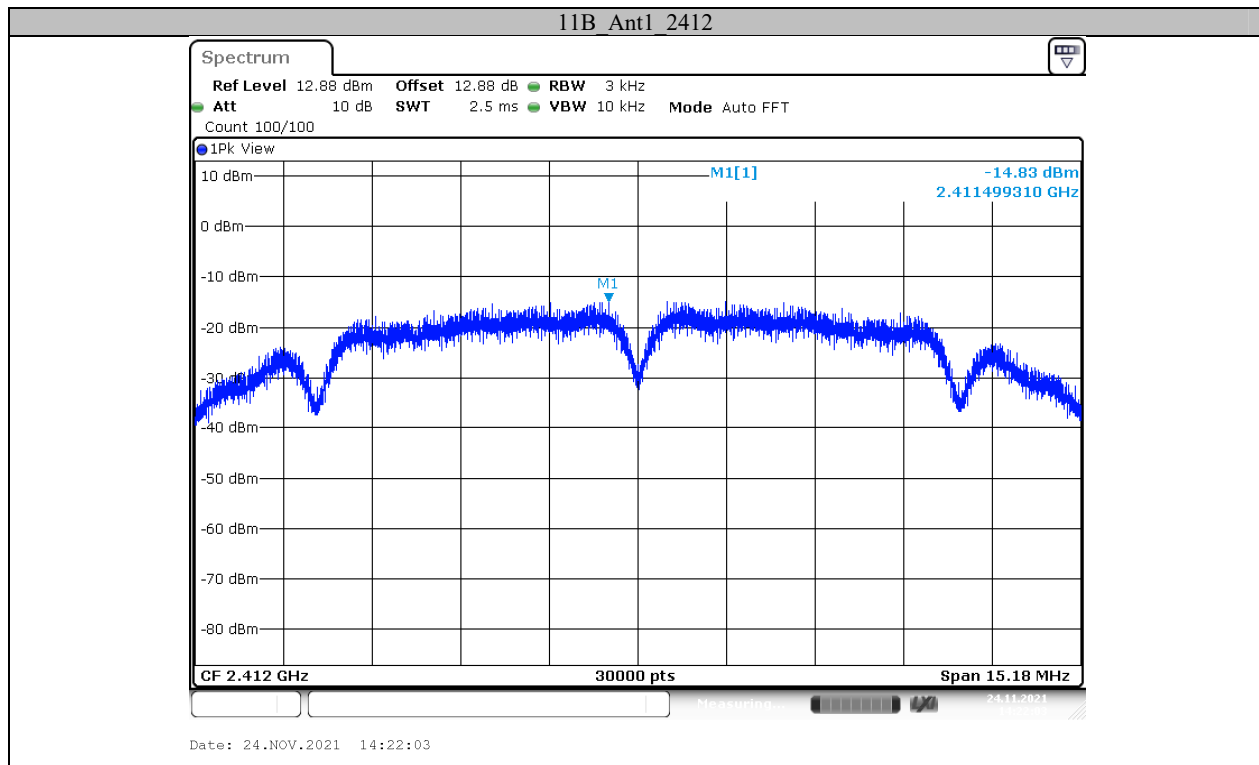

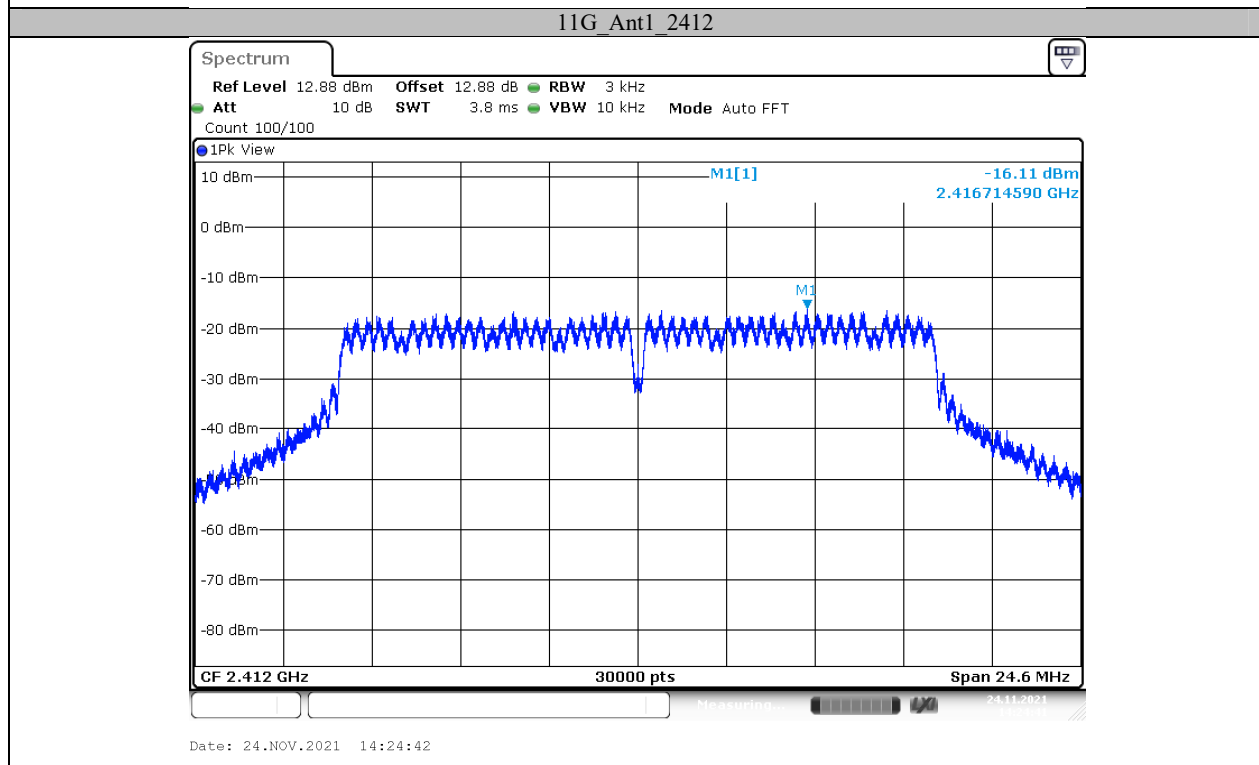
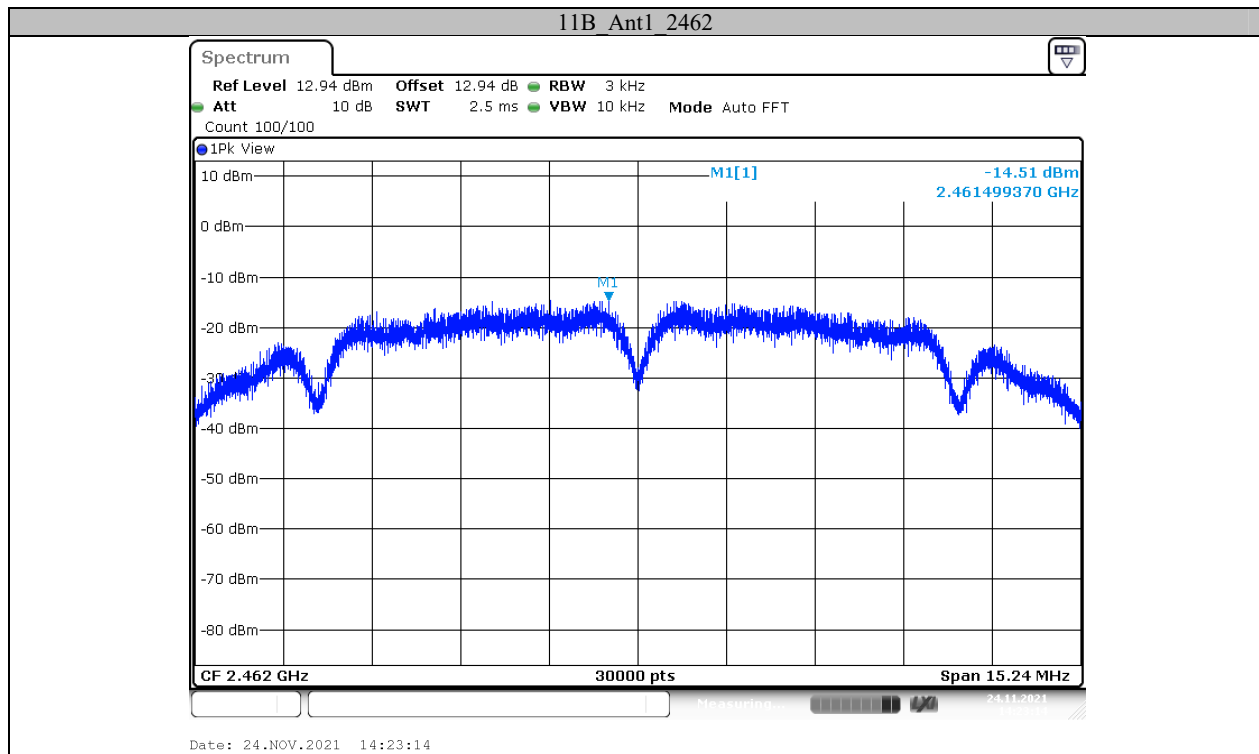

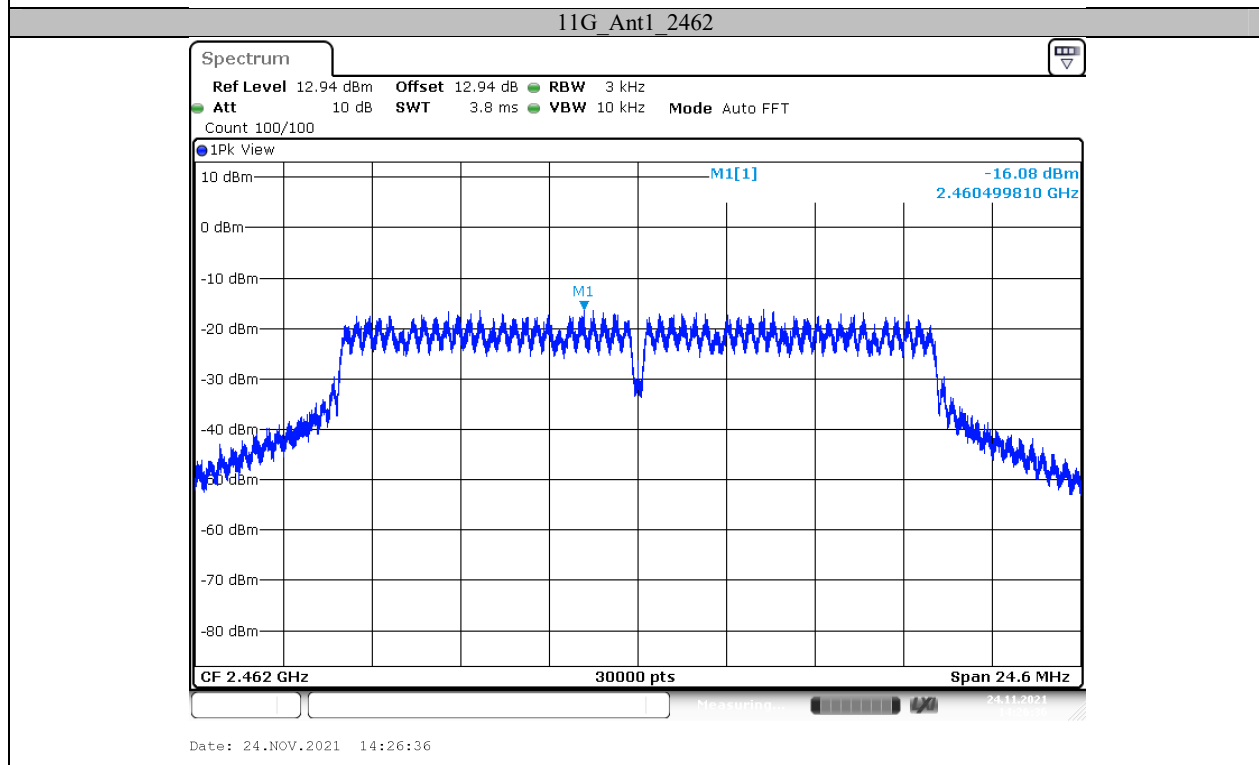
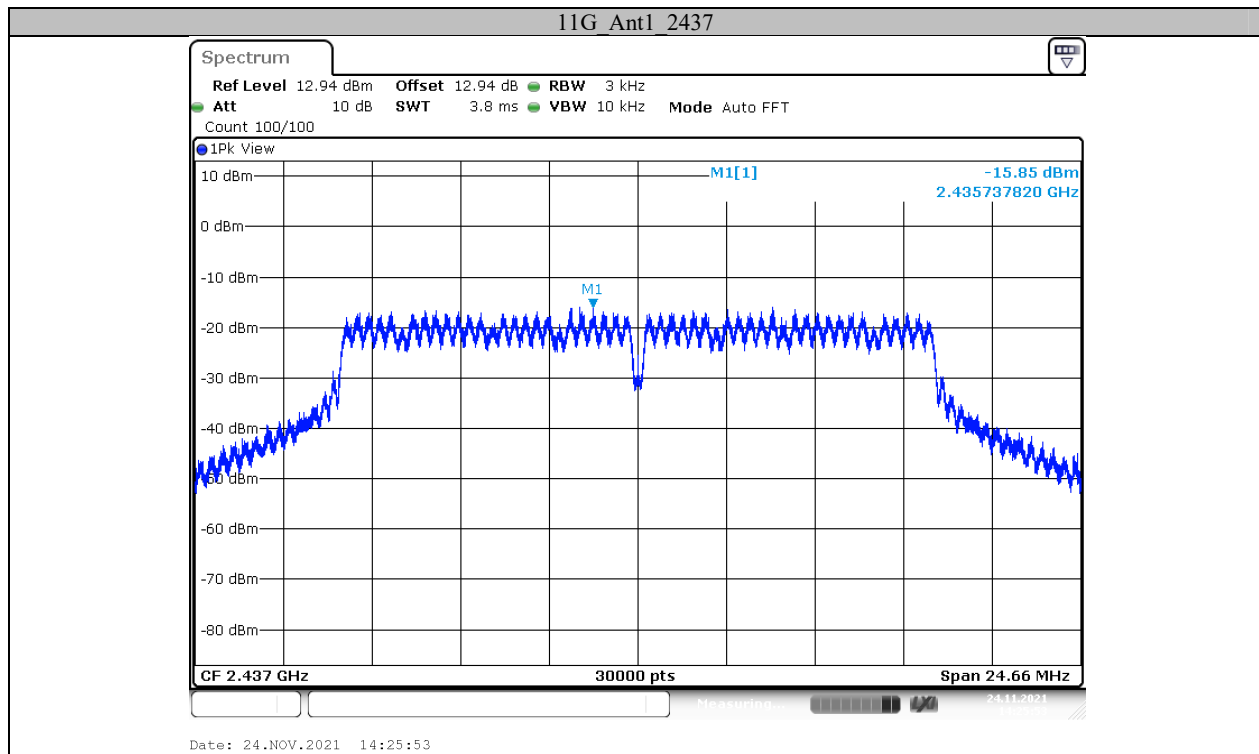

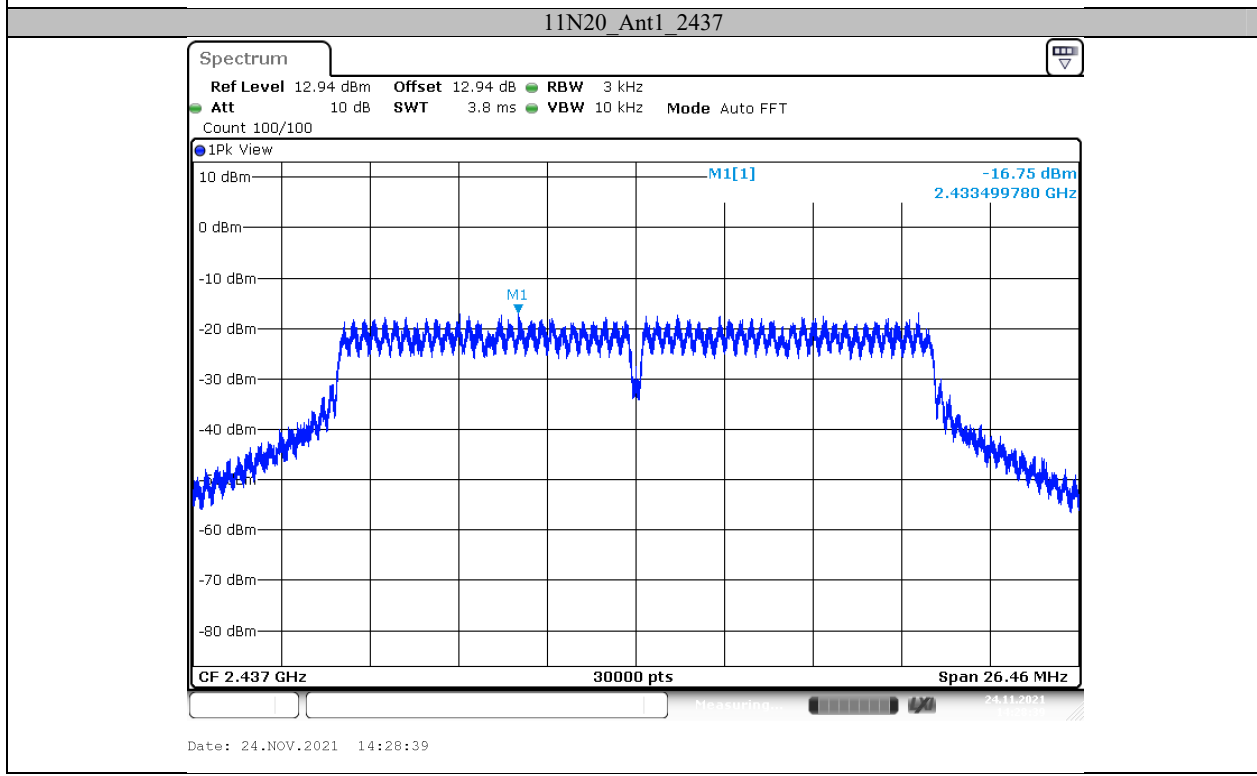
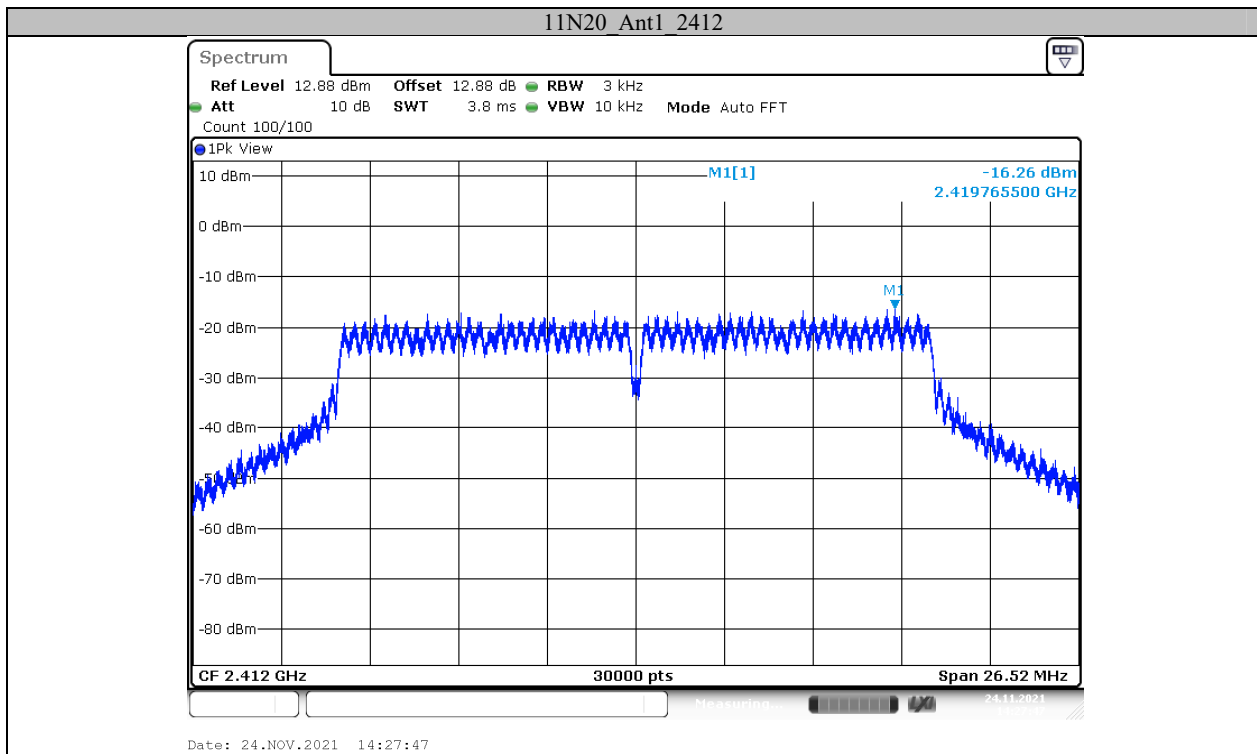

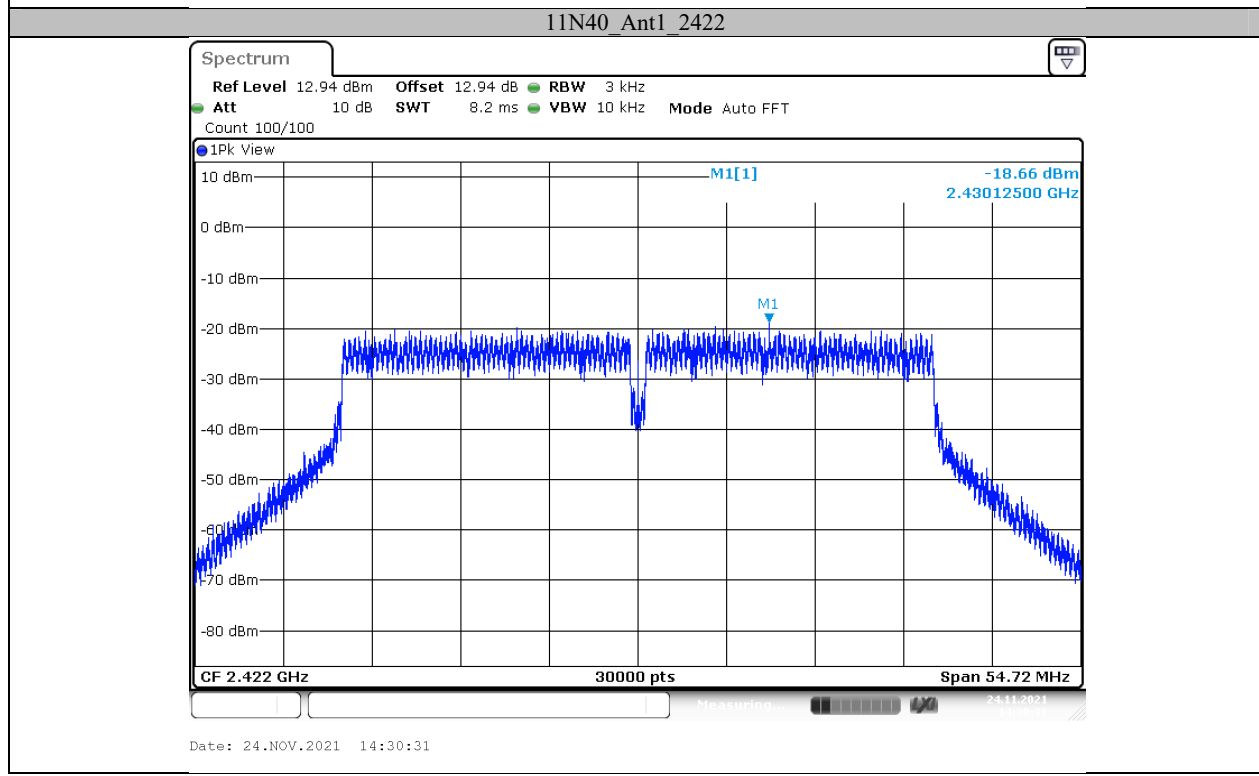
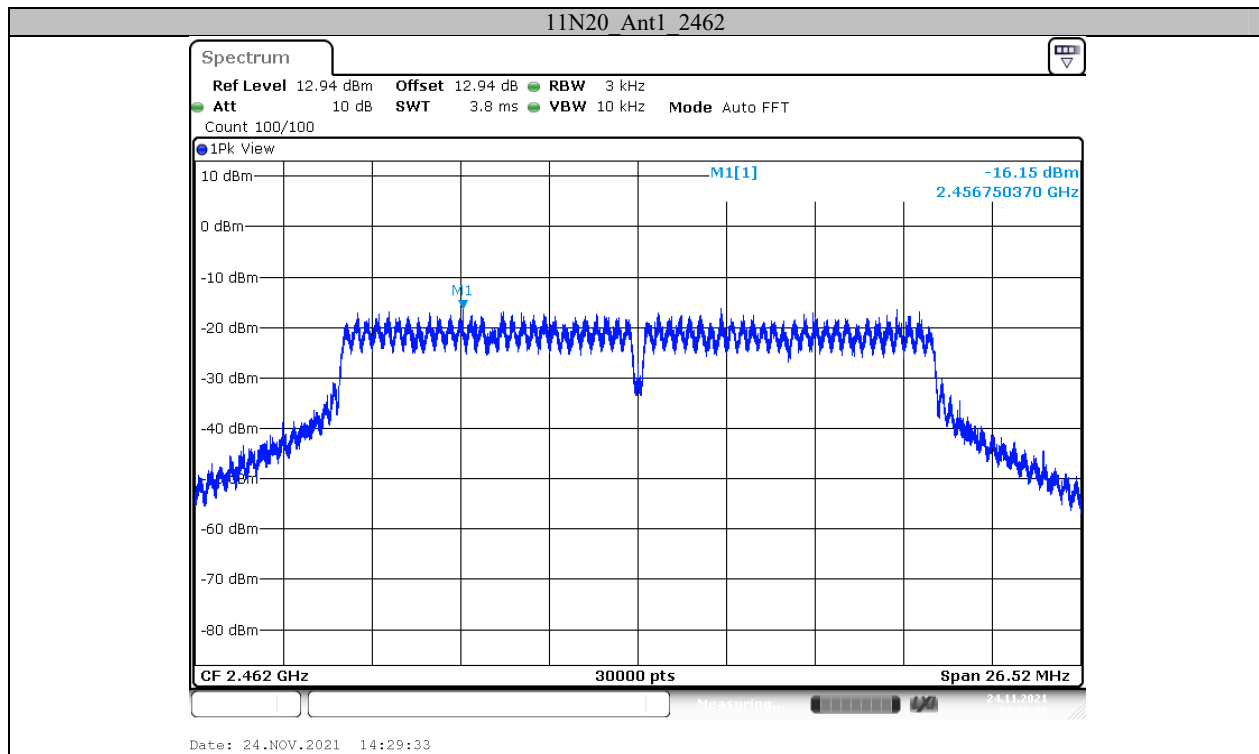

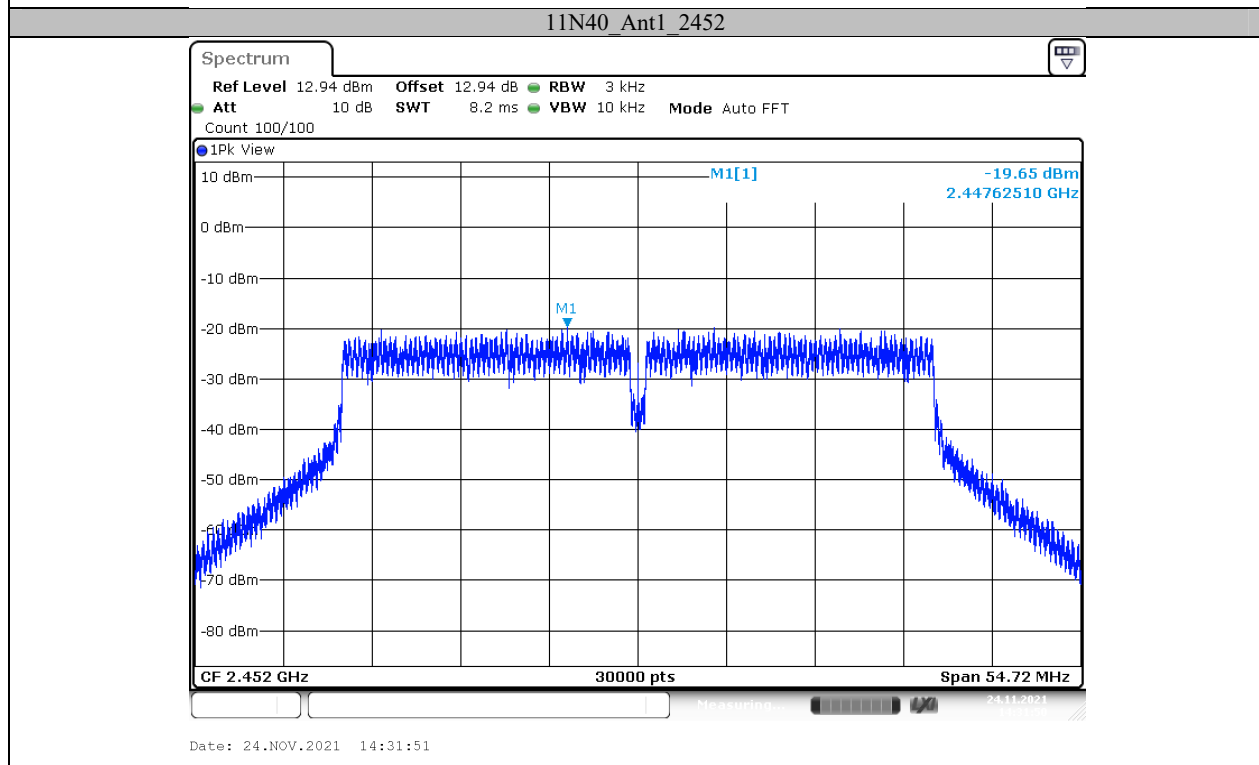
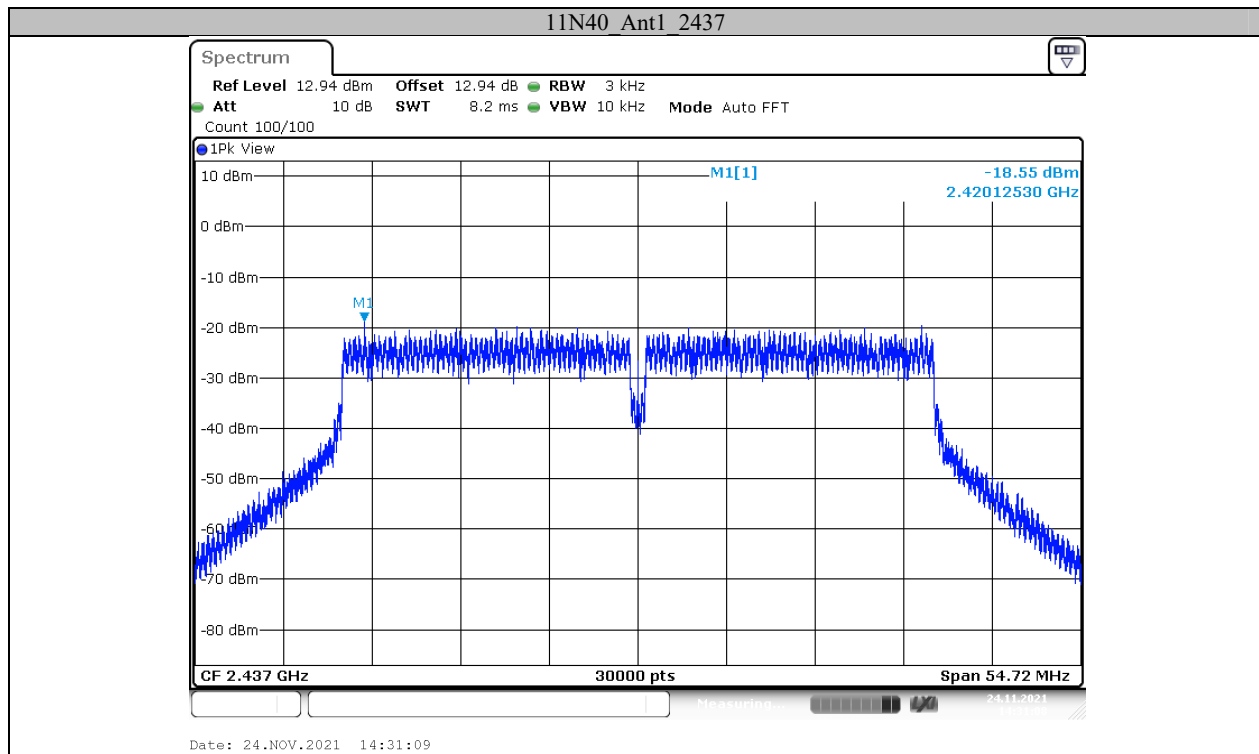

Appendix E: Band edge measurements

Test Graphs

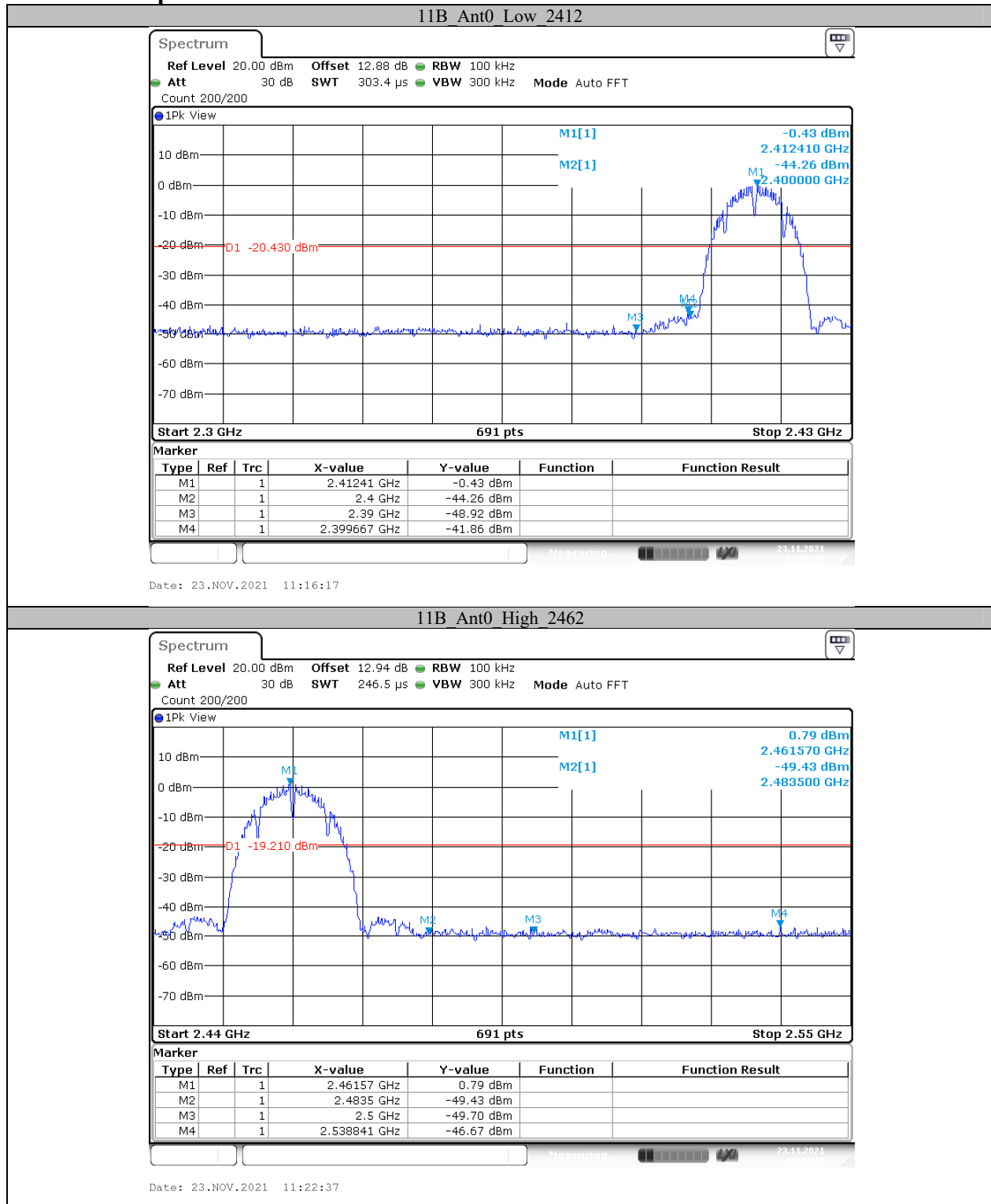

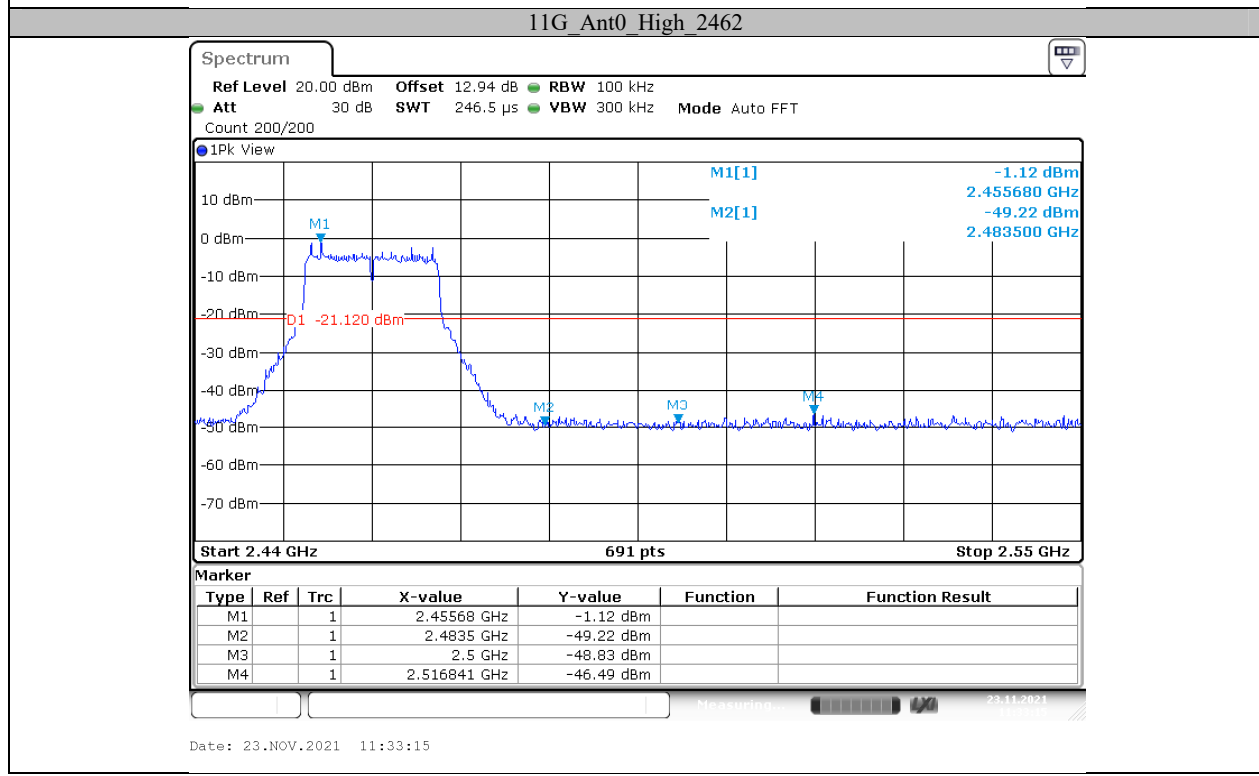
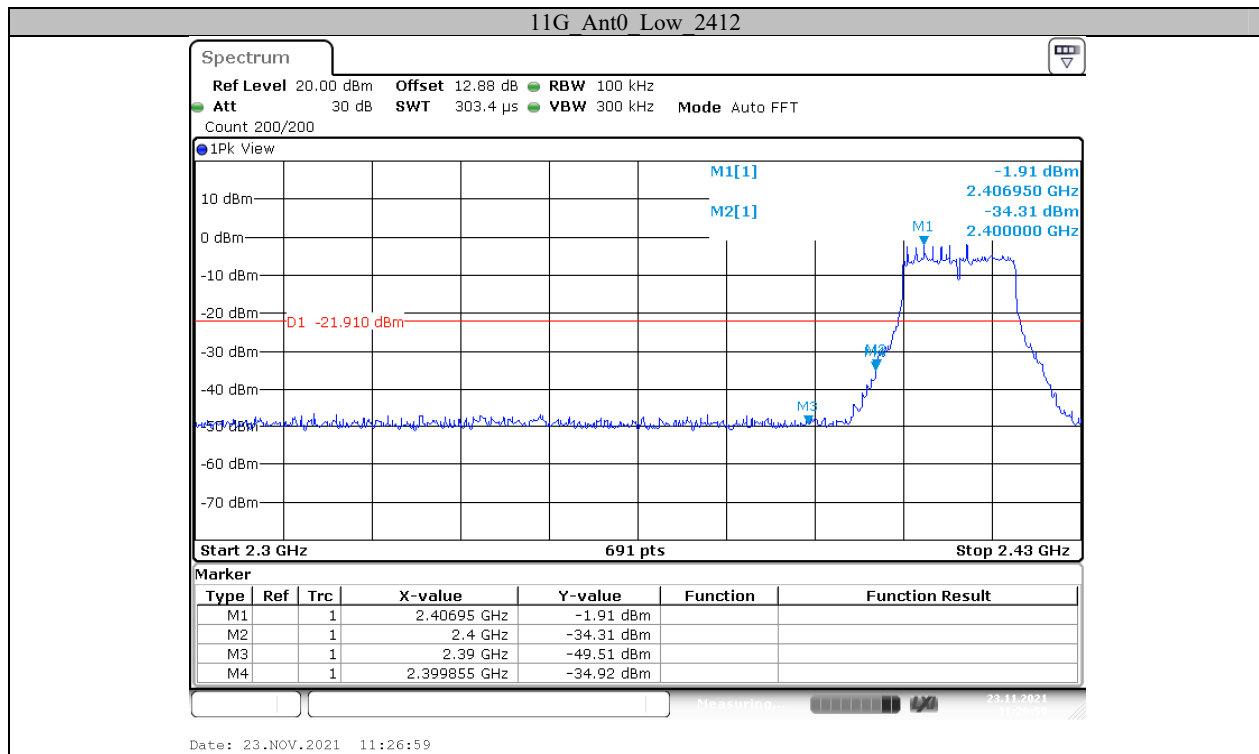

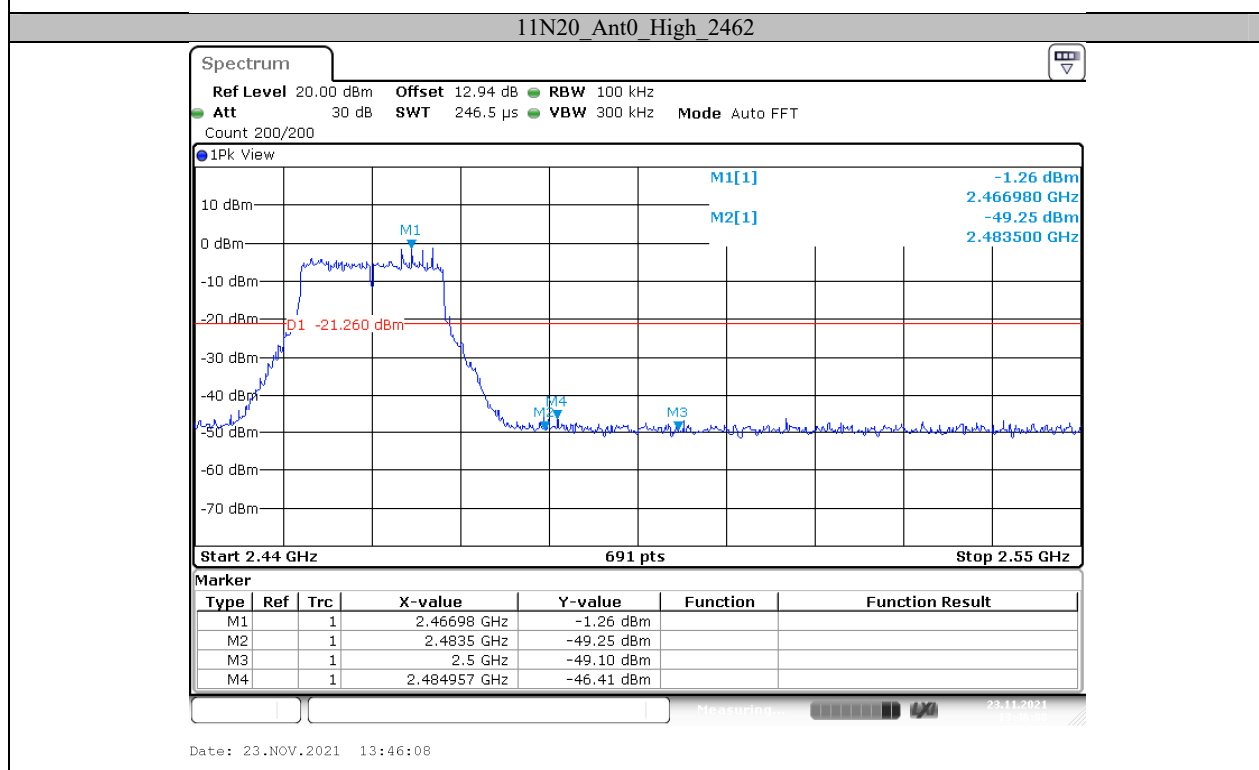
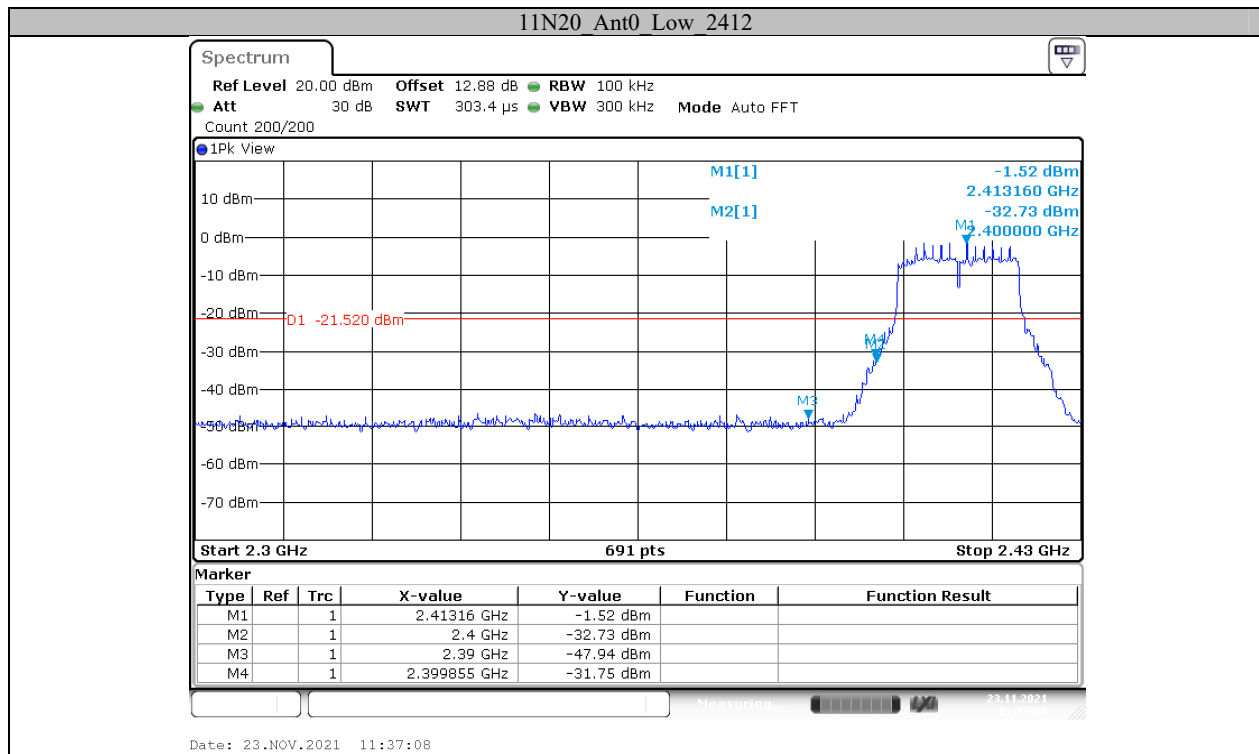

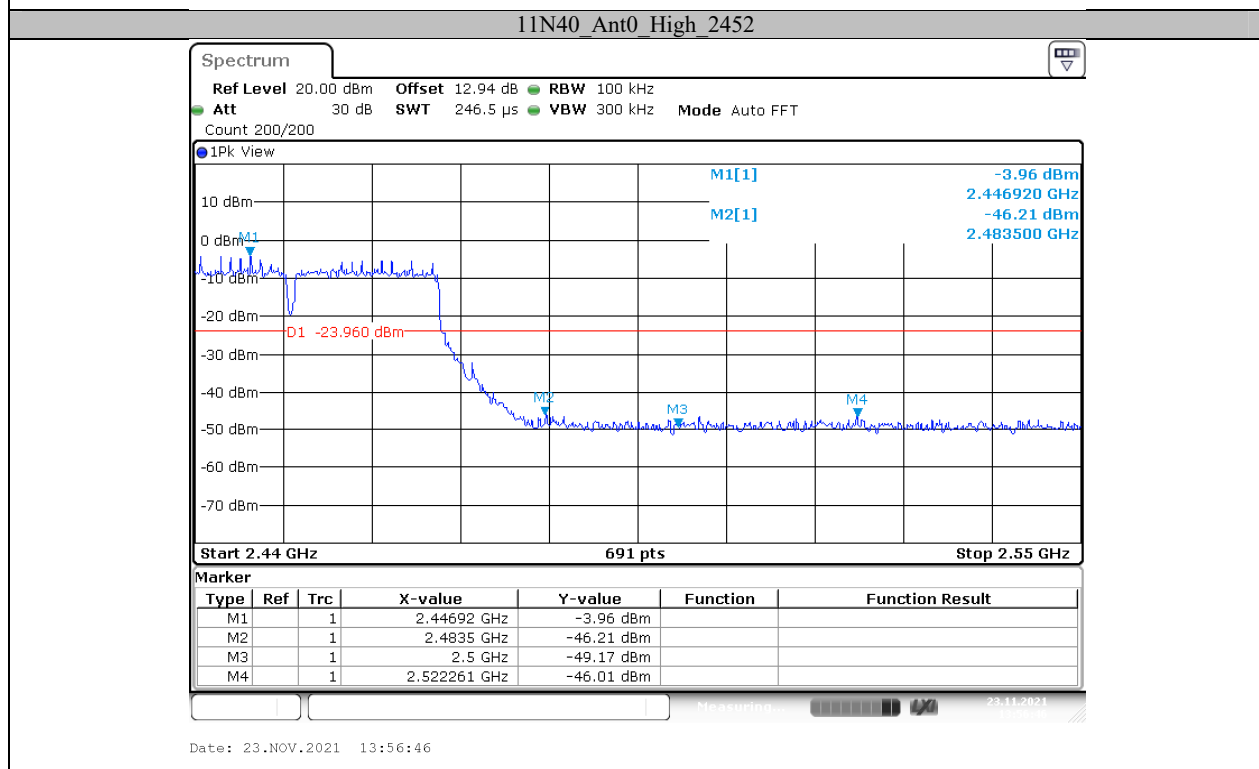
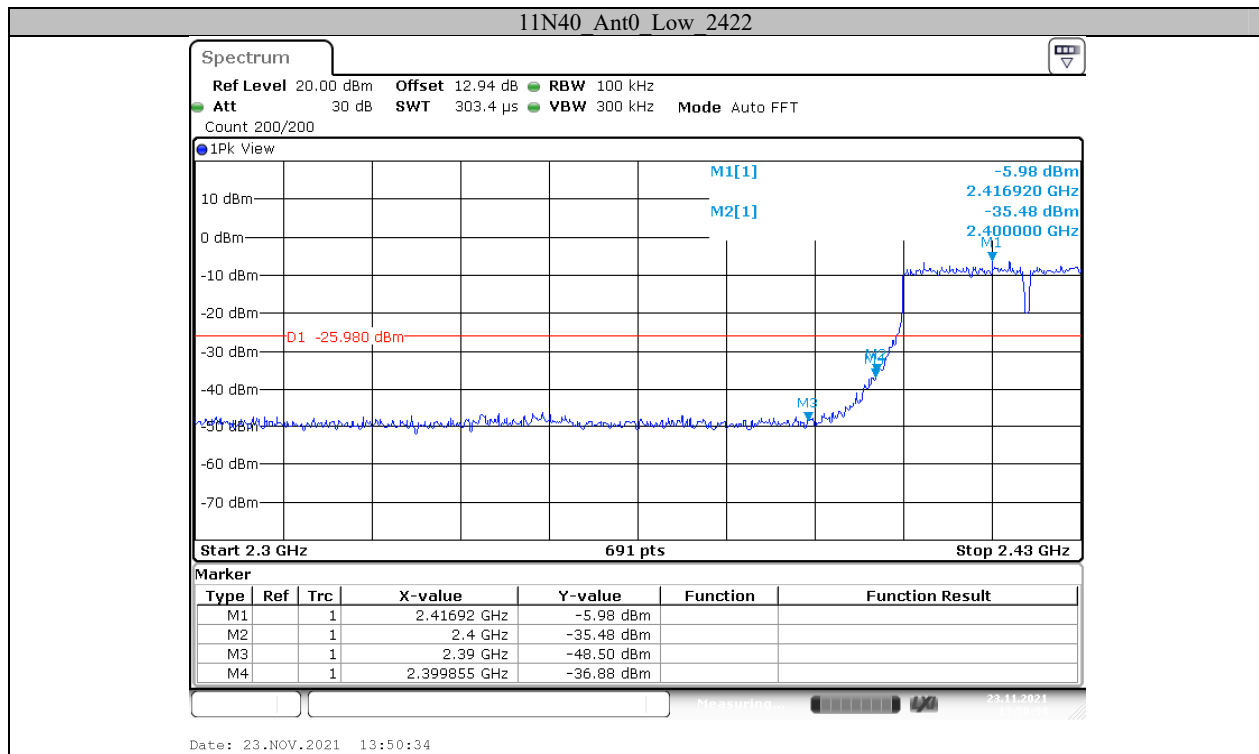

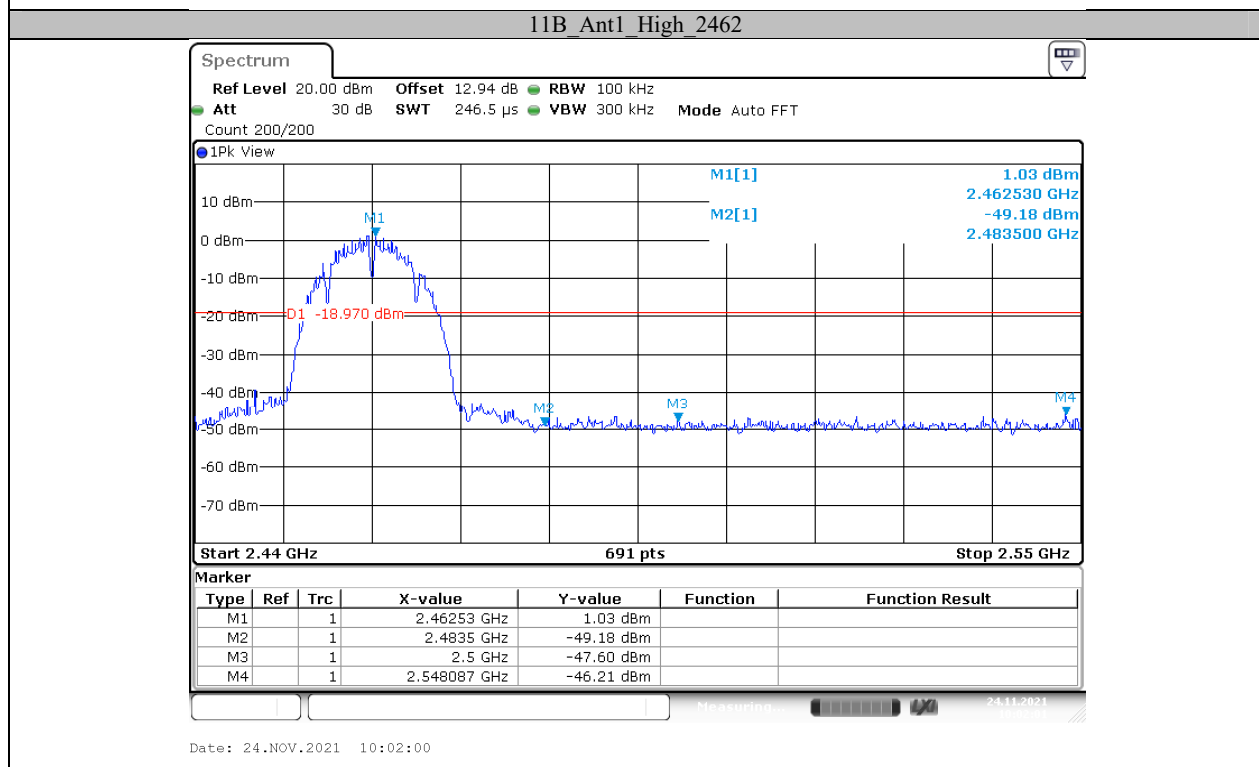
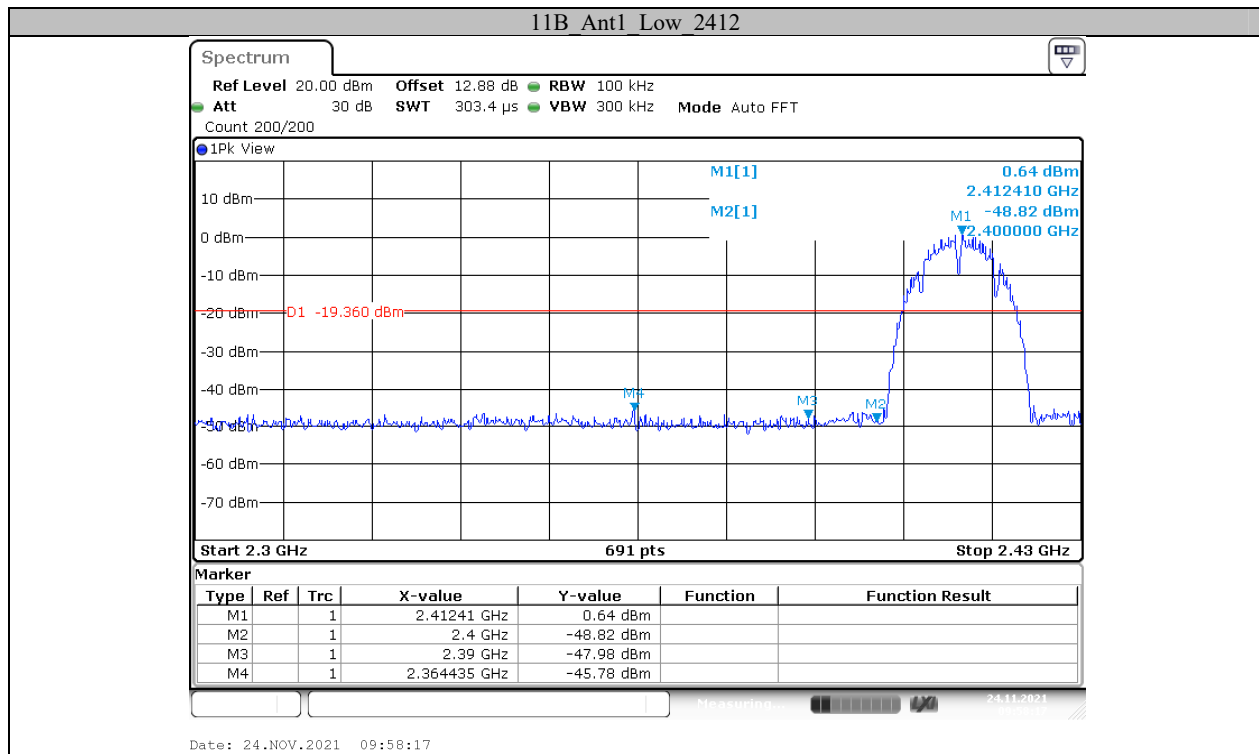

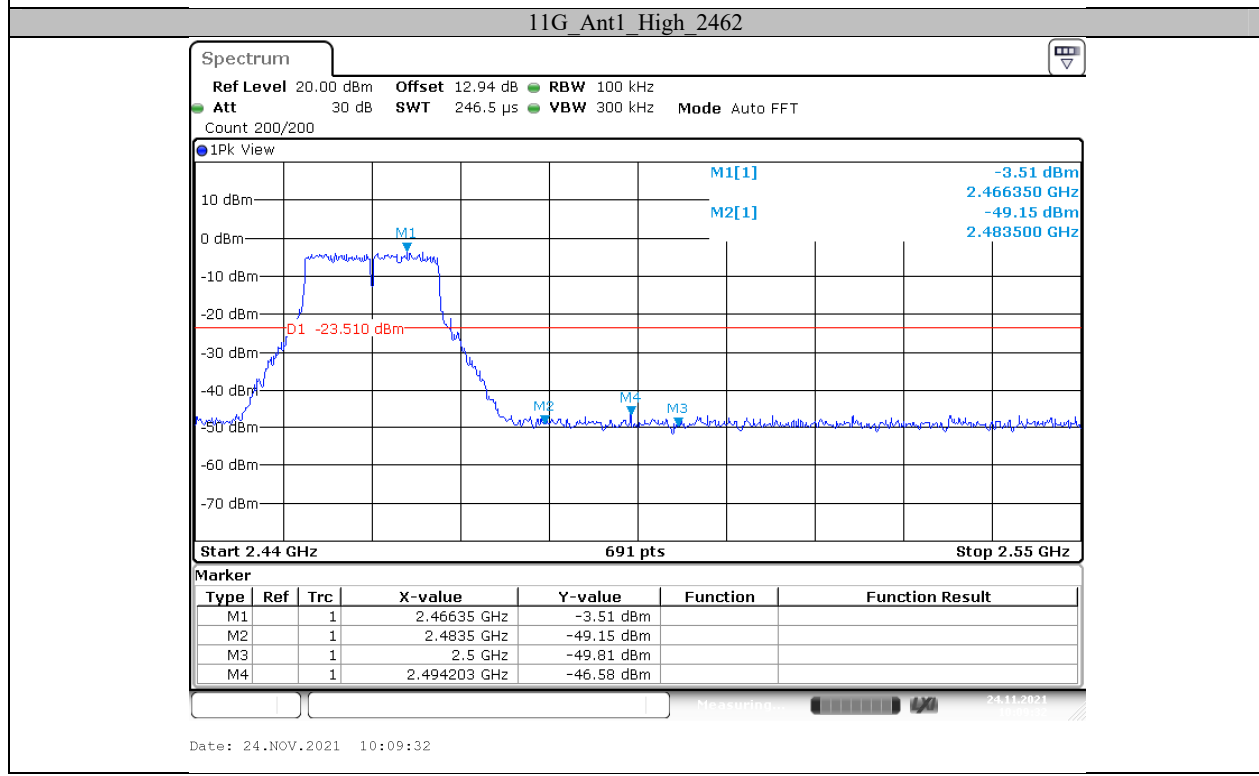
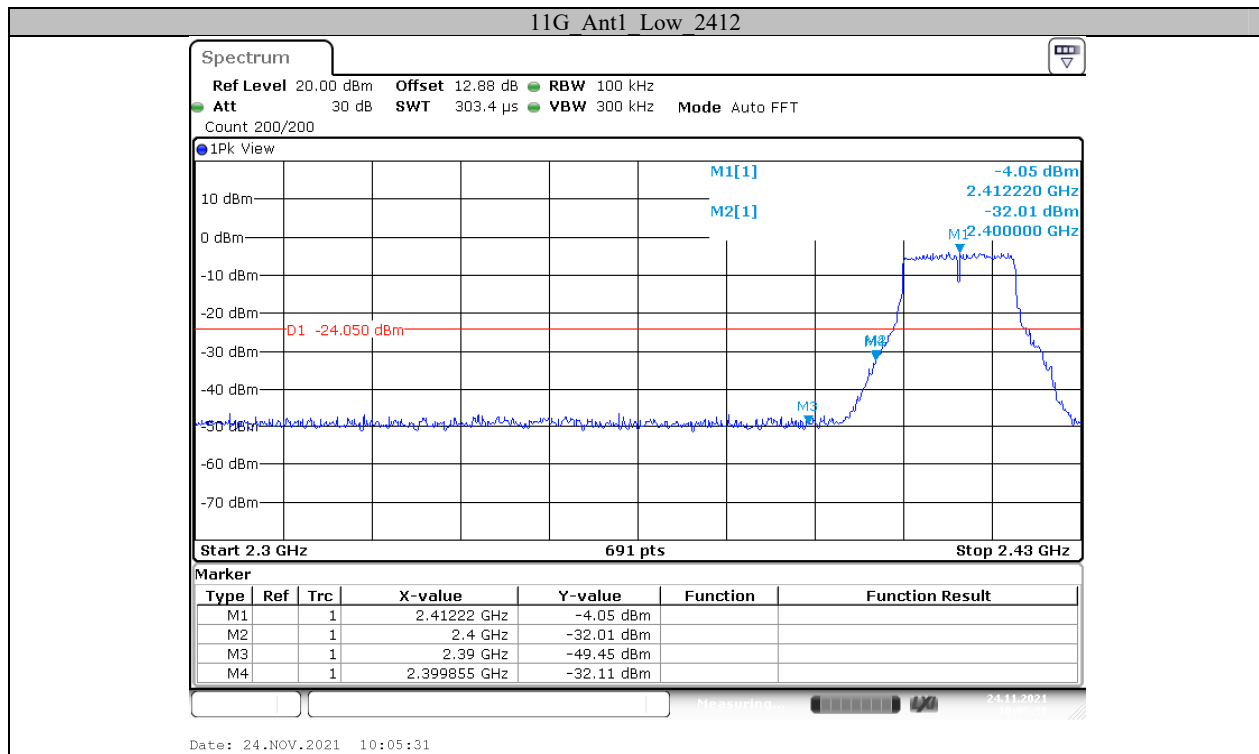

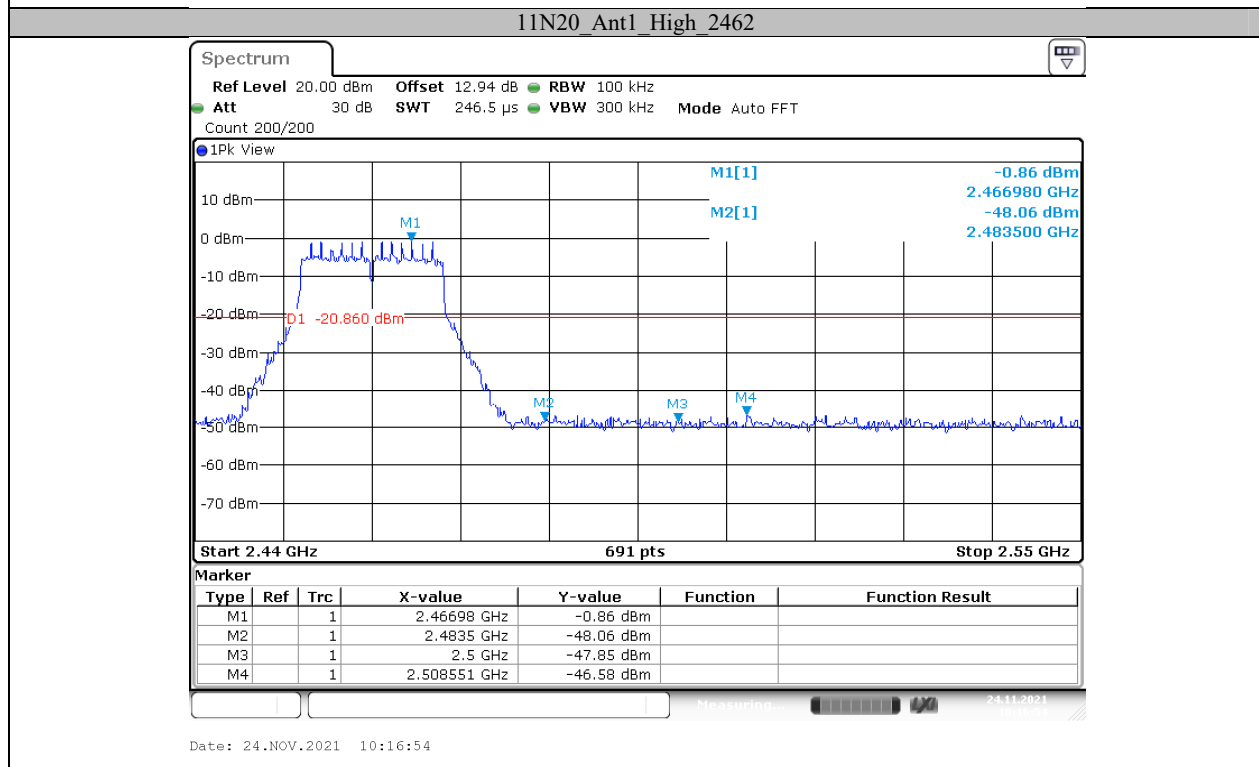
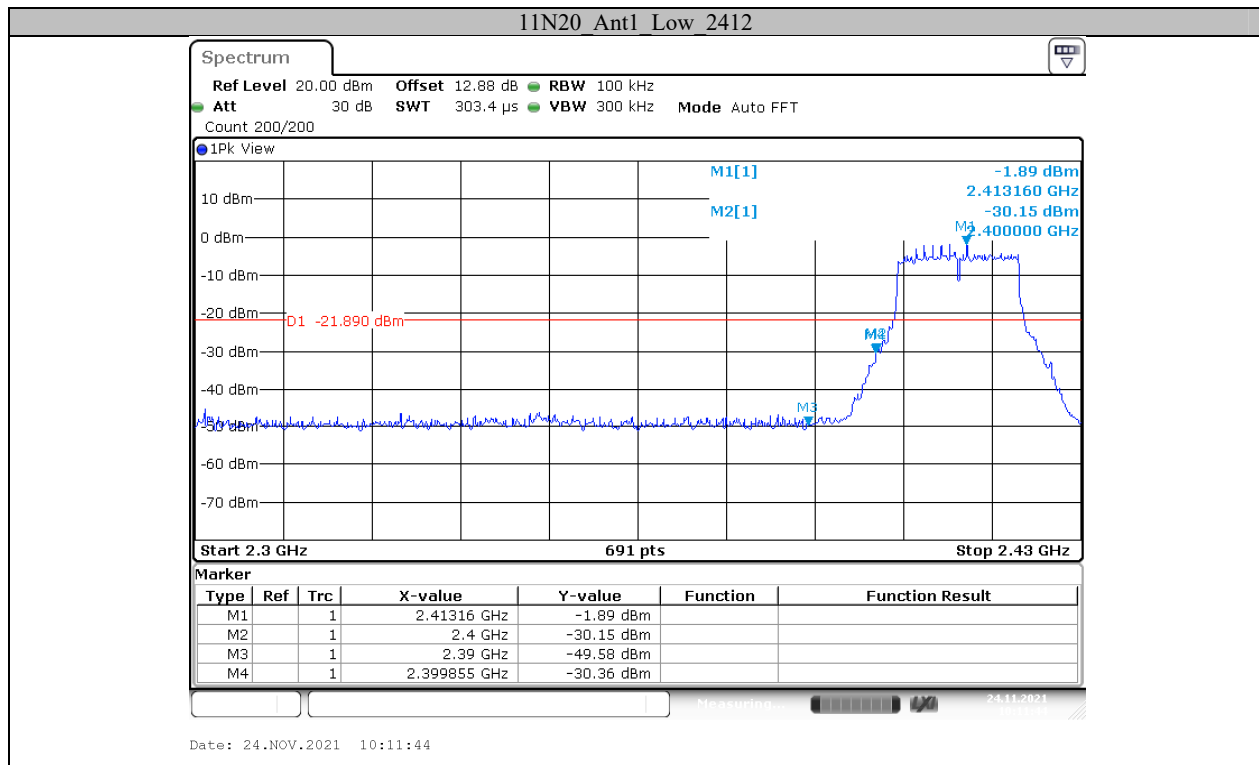

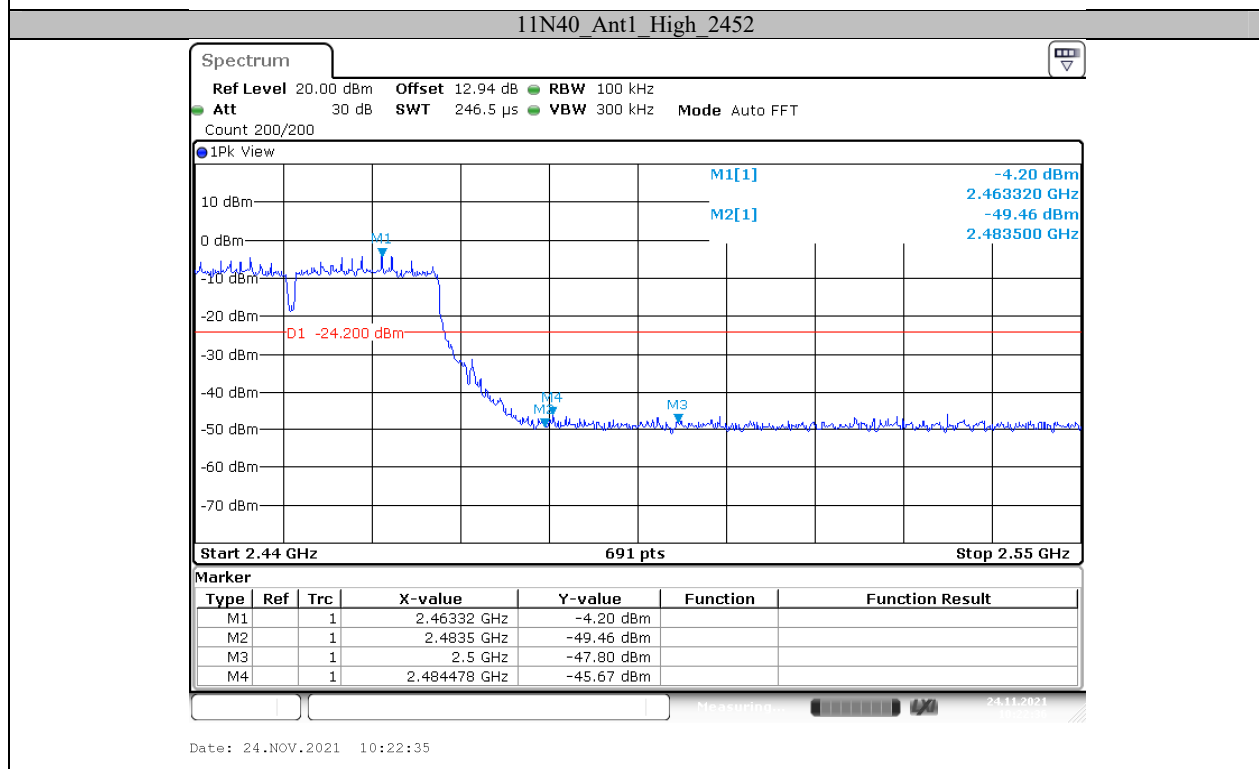
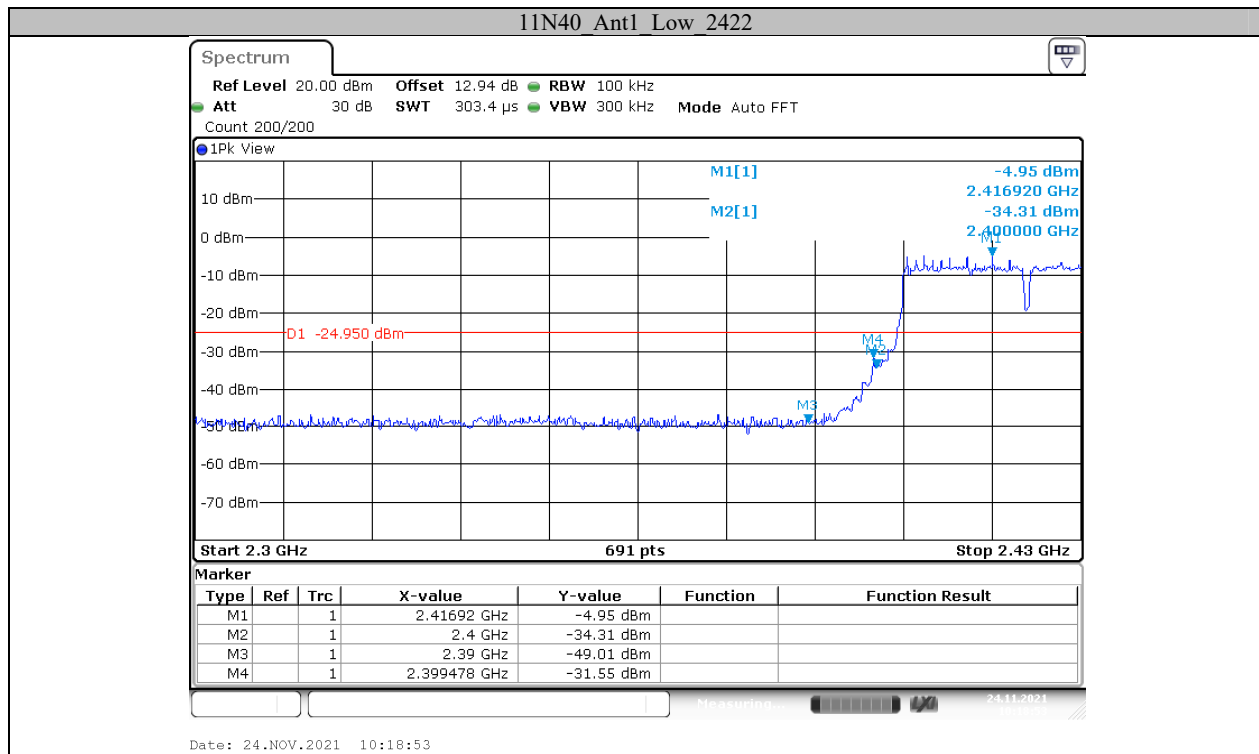

Appendix F: Duty Cycle**Test Result**

TestMode	Antenna	Channel [MHz]	Transmission Duration [ms]	Transmission Period [ms]	Duty Cycle [%]
11B	Ant0	2412	12.18	12.72	95.75
		2437	12.37	12.75	97.02
		2462	12.35	12.81	96.41
11G	Ant0	2412	1.02	1.23	82.93
		2437	1.02	1.23	82.93
		2462	1.02	1.23	82.93
11N20	Ant0	2412	1.89	2.26	83.63
		2437	1.89	2.25	84.00
		2462	1.89	2.26	83.63
11N40	Ant0	2422	0.92	1.11	82.88
		2437	0.92	1.11	82.88
		2452	0.92	1.11	82.88

TestMode	Antenna	Channel [MHz]	Transmission Duration [ms]	Transmission Period [ms]	Duty Cycle [%]
11B	Ant1	2412	12.16	12.72	95.60
		2437	12.16	12.72	95.60
		2462	12.16	12.72	95.60
11G	Ant1	2412	2.03	2.42	83.88
		2437	2.03	2.42	83.88
		2462	2.03	2.42	83.88
11N20	Ant1	2412	1.89	2.25	84.00
		2437	1.89	2.26	83.63
		2462	1.89	2.25	84.00
11N40	Ant1	2422	0.92	1.11	82.88
		2437	0.92	1.11	82.88
		2452	0.92	1.11	82.88

Test Graphs

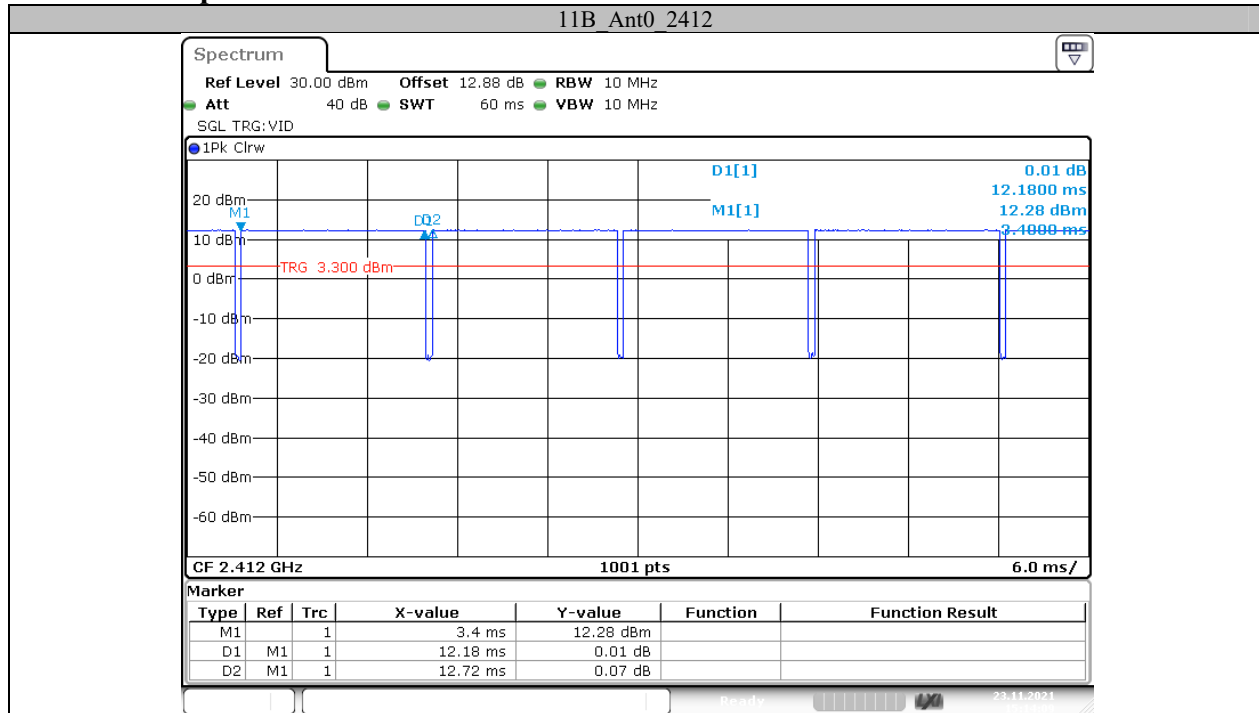

Date: 23.NOV.2021 15:14:10

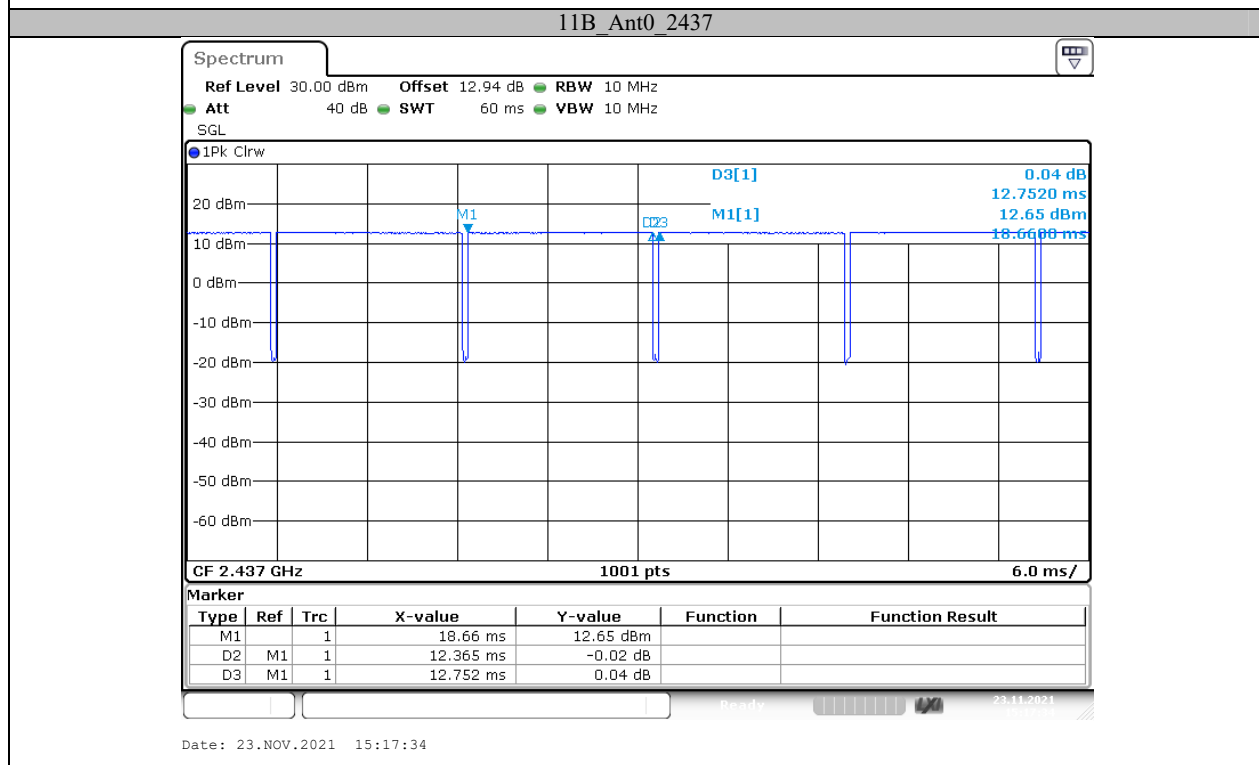

Date: 23.NOV.2021 15:17:34

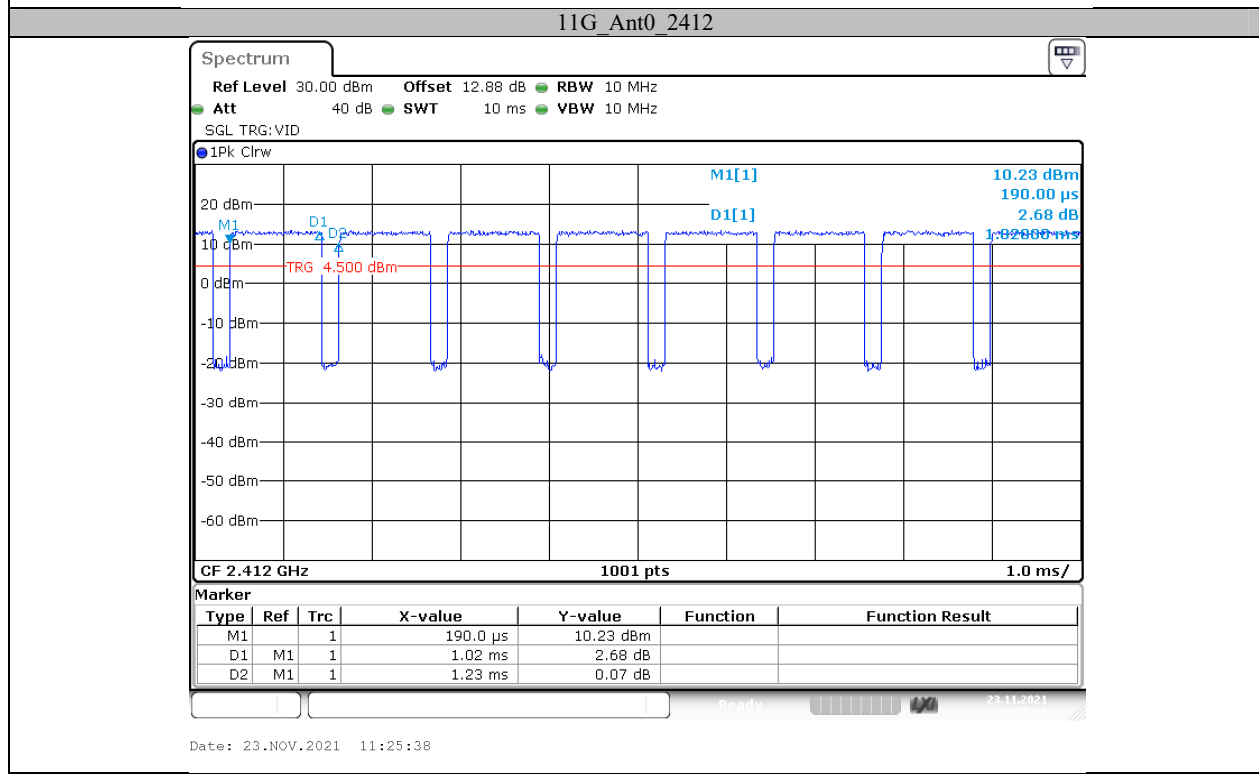
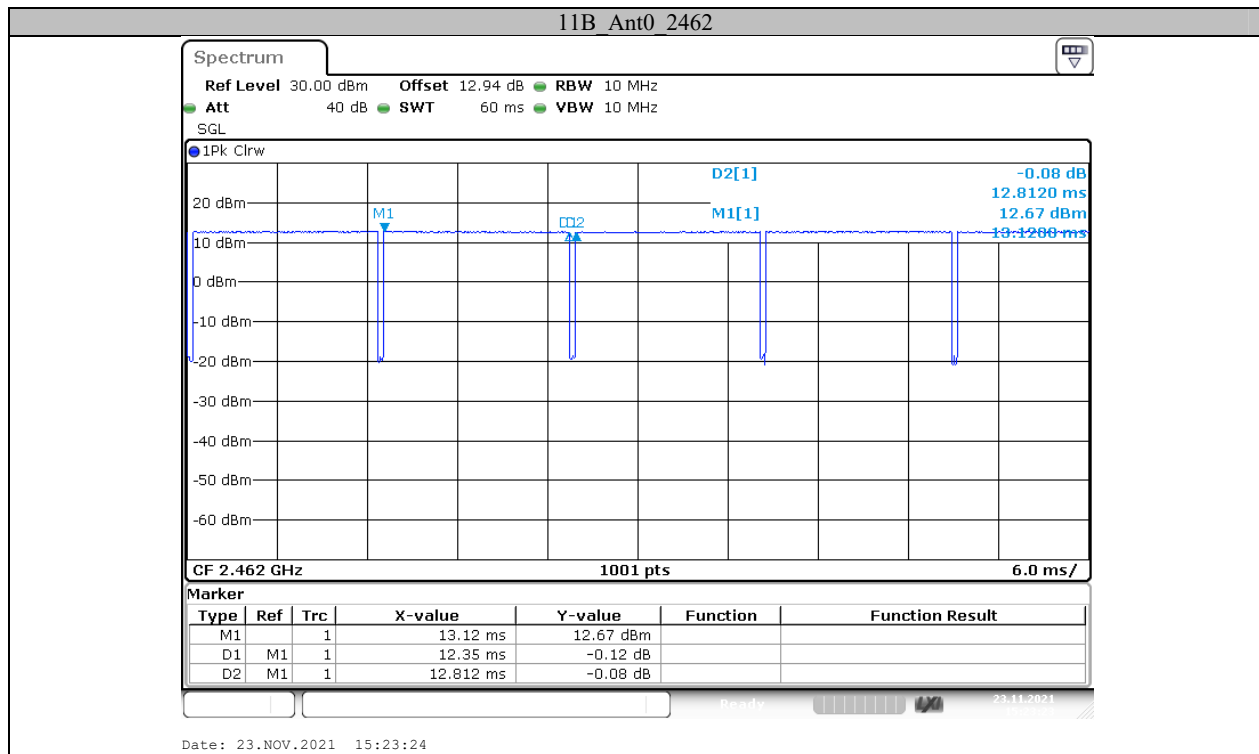

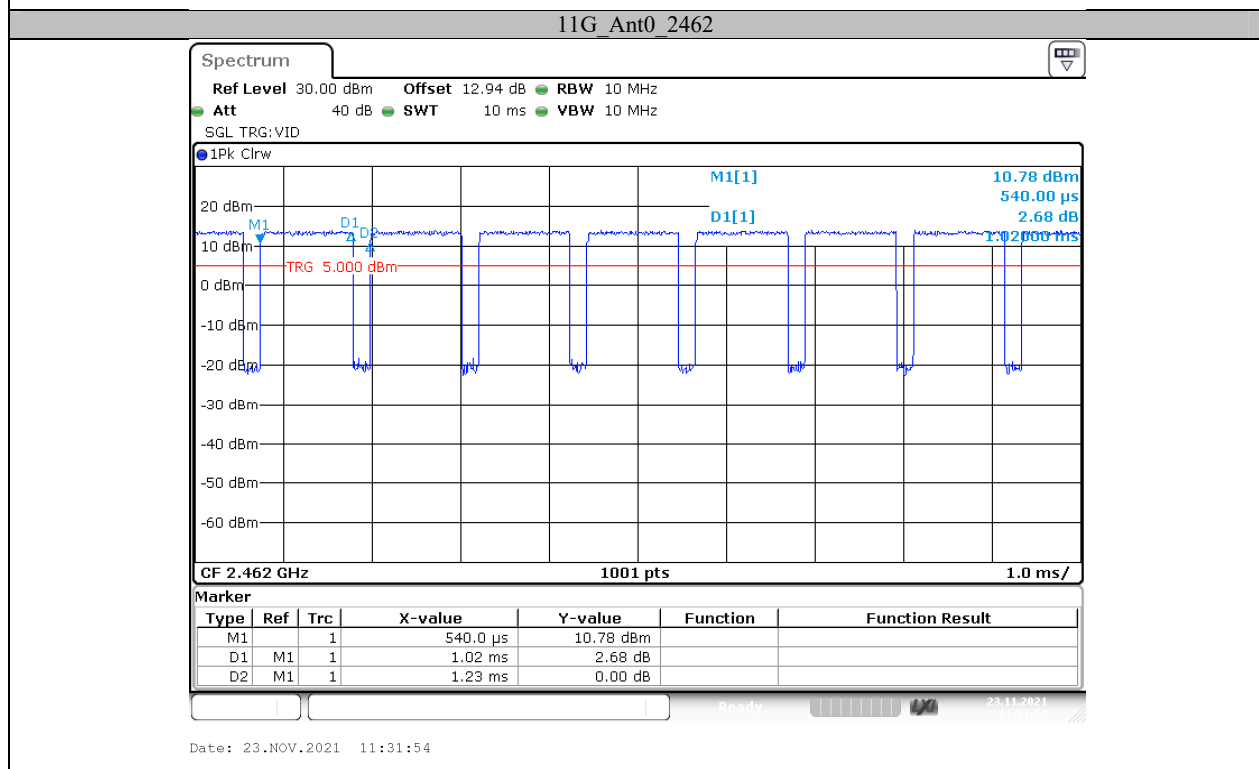
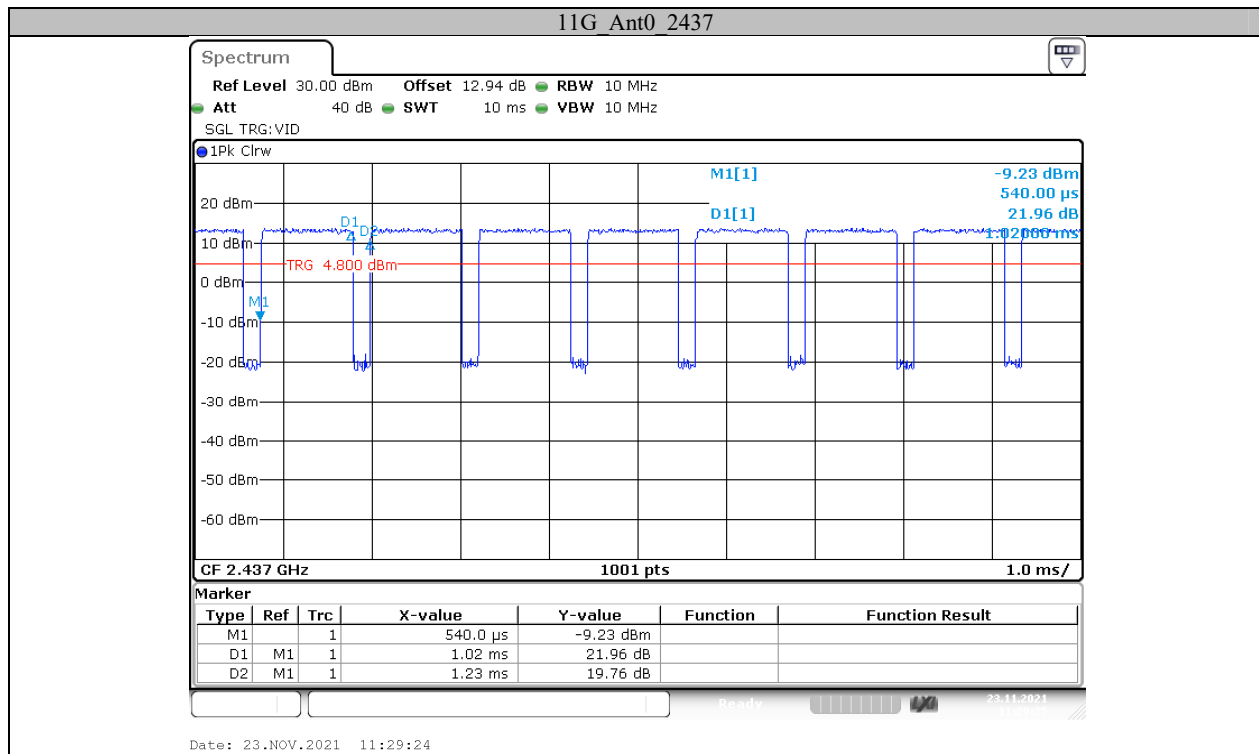

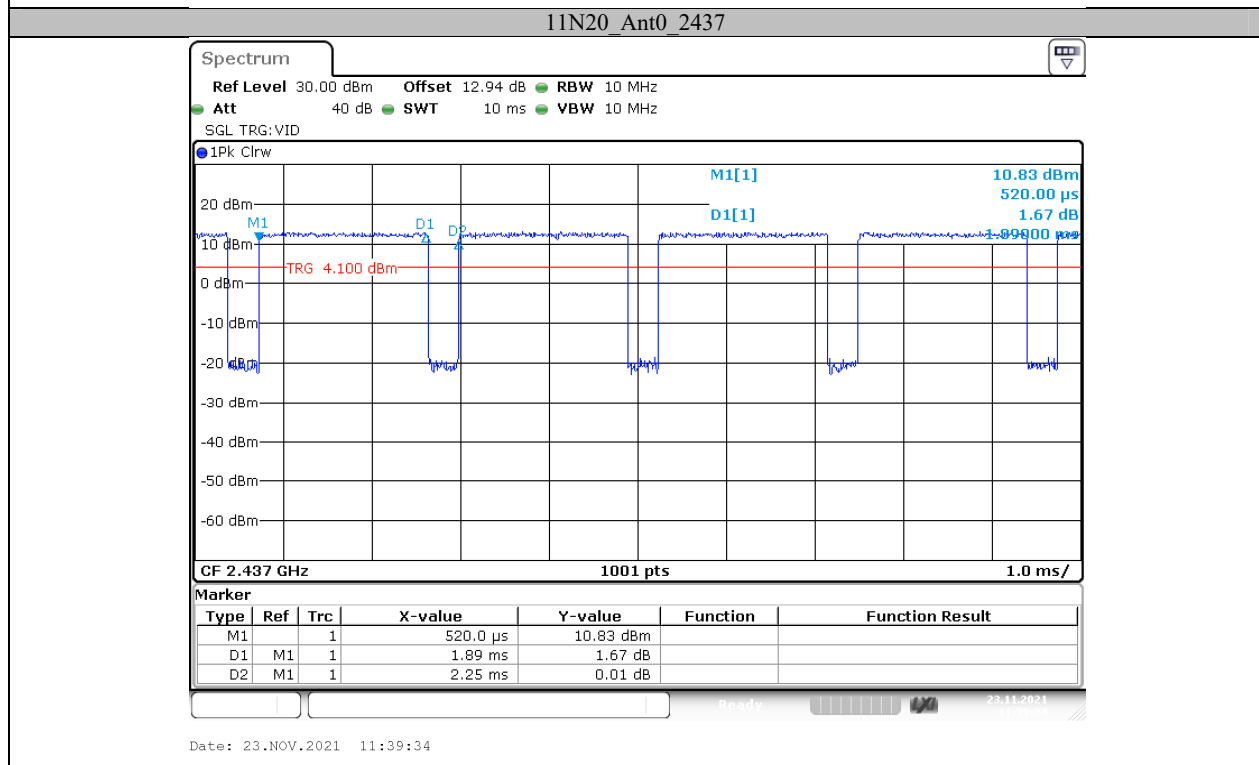
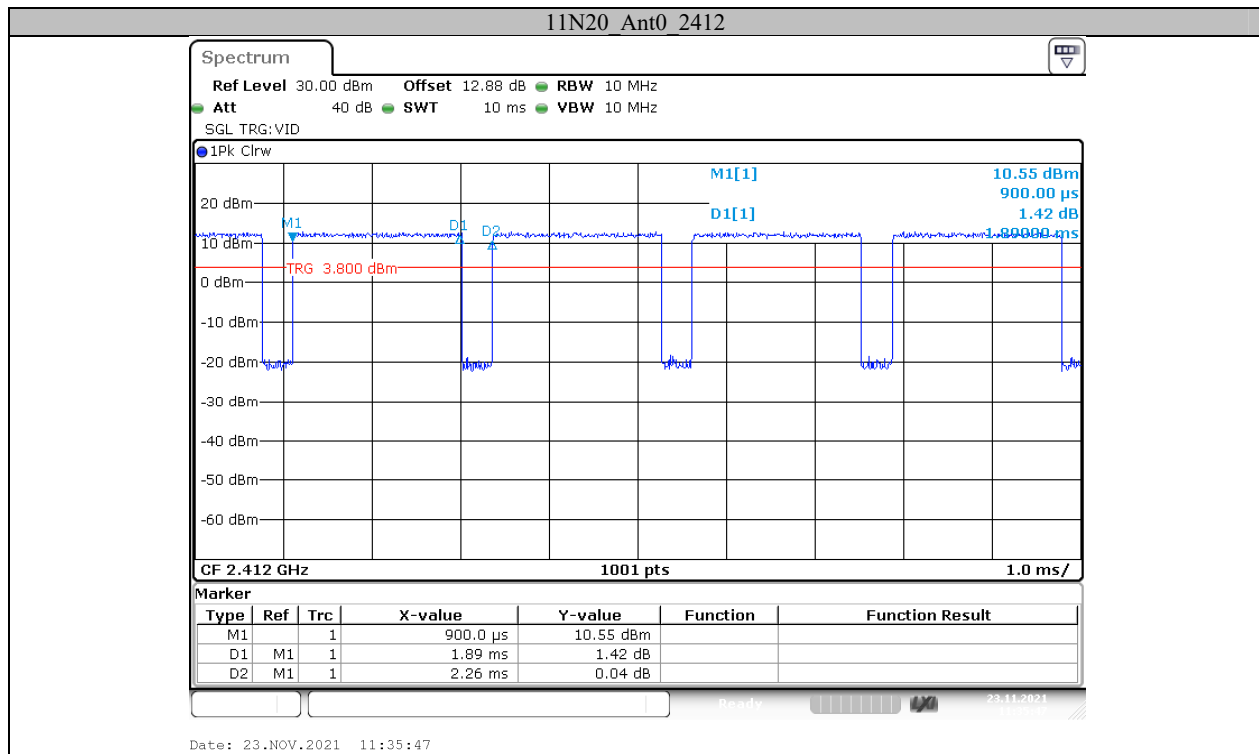

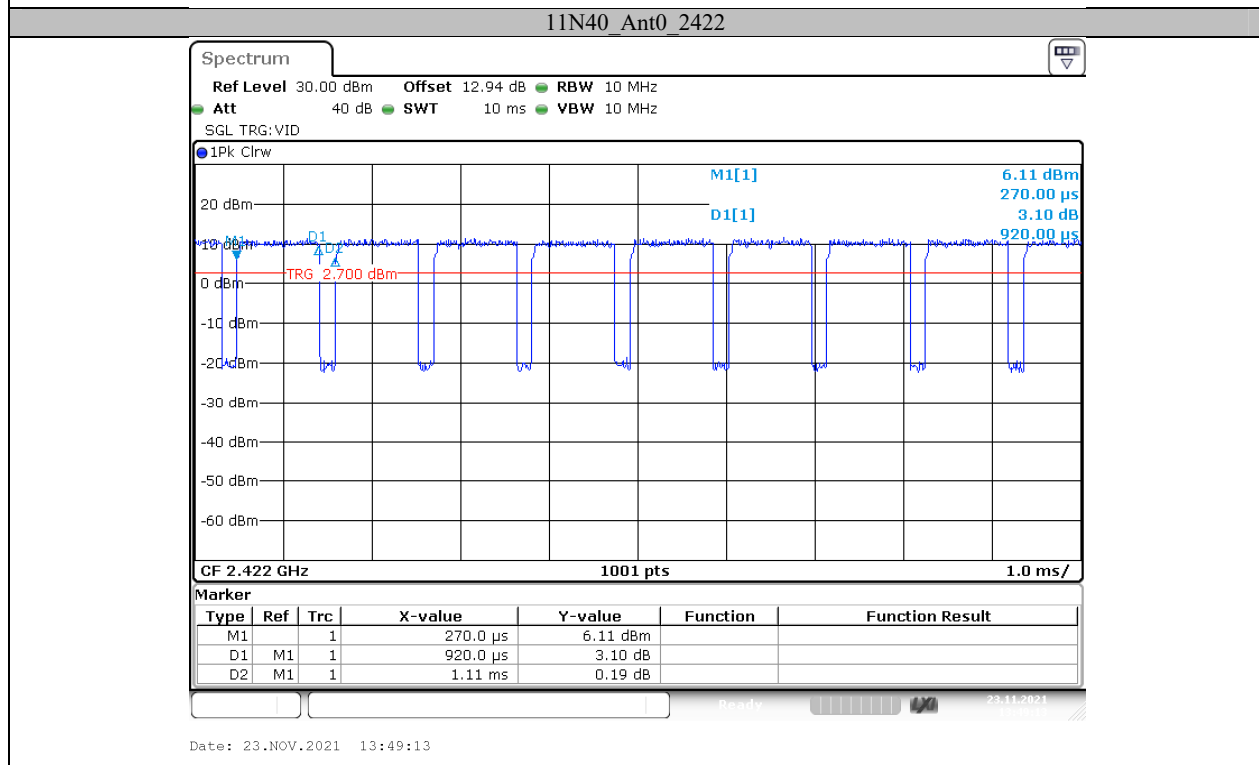
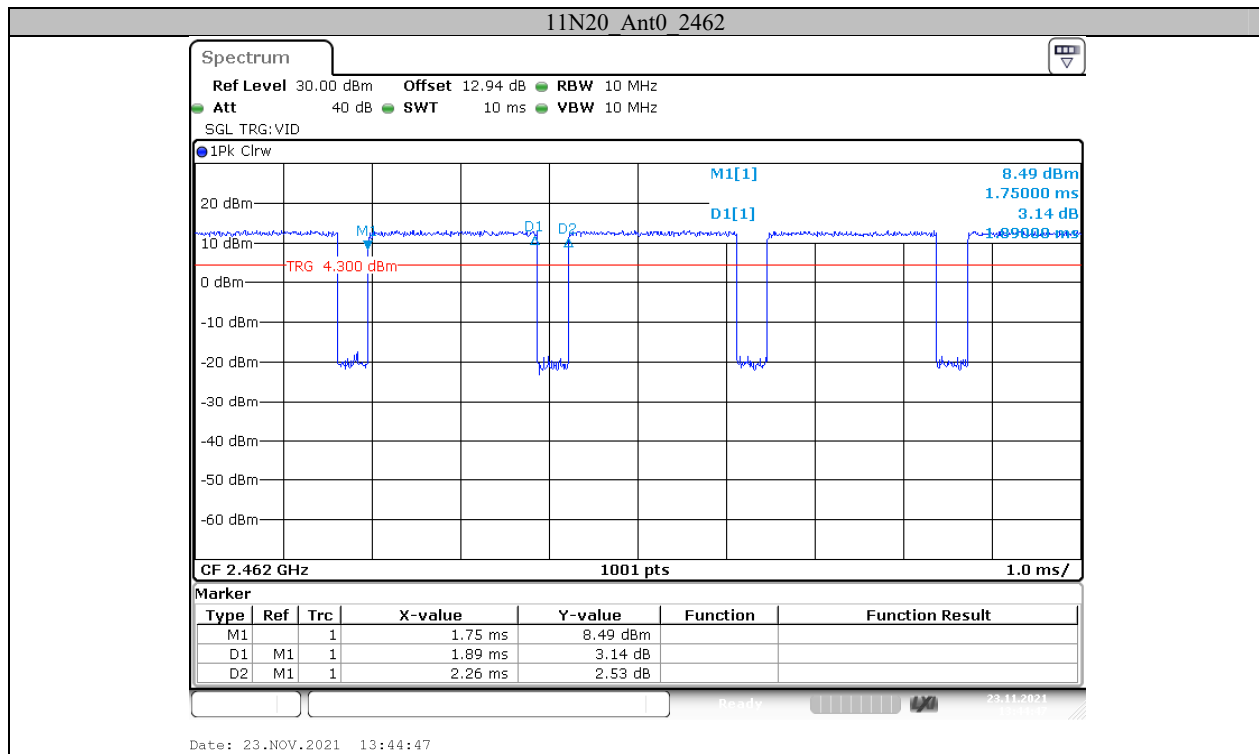

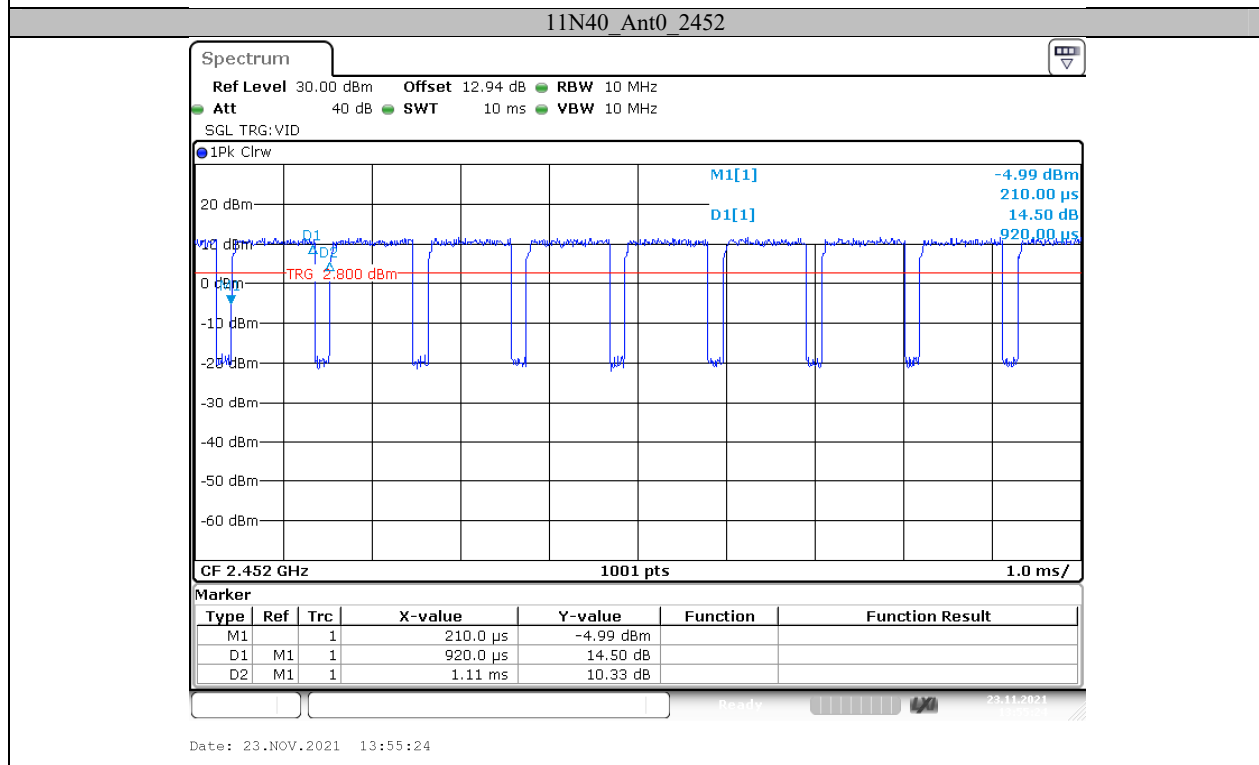
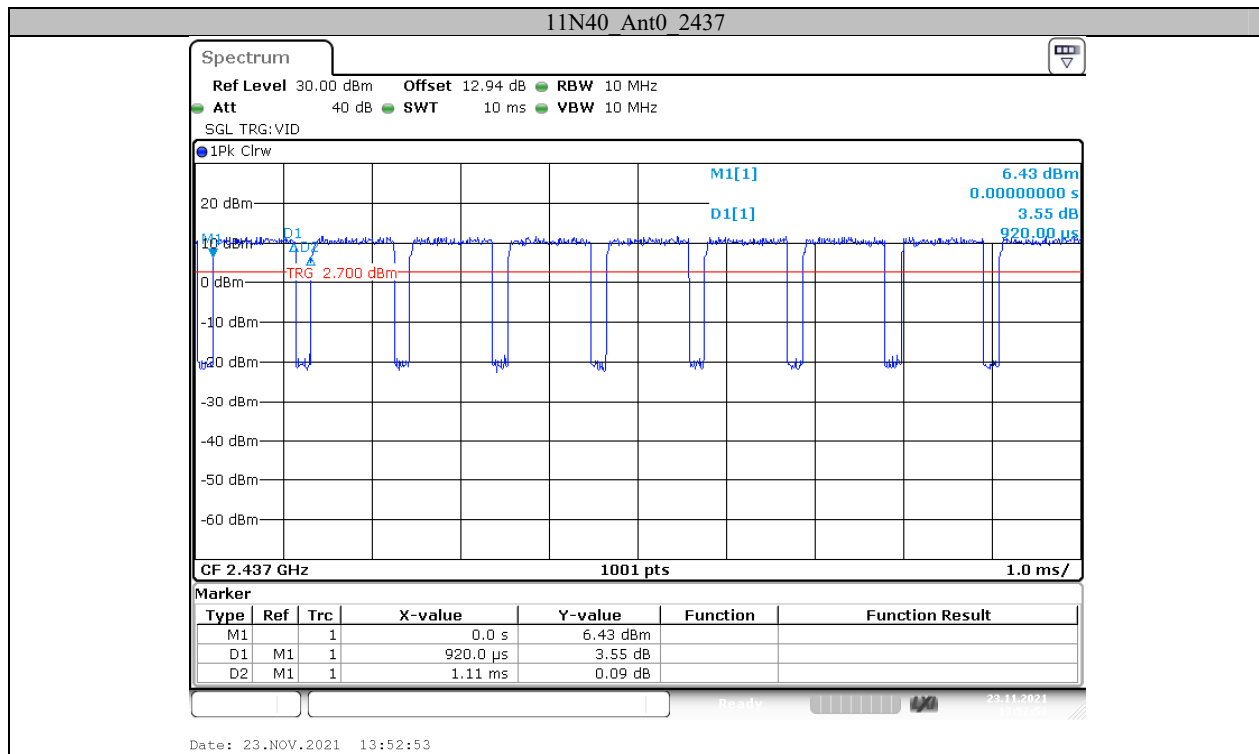

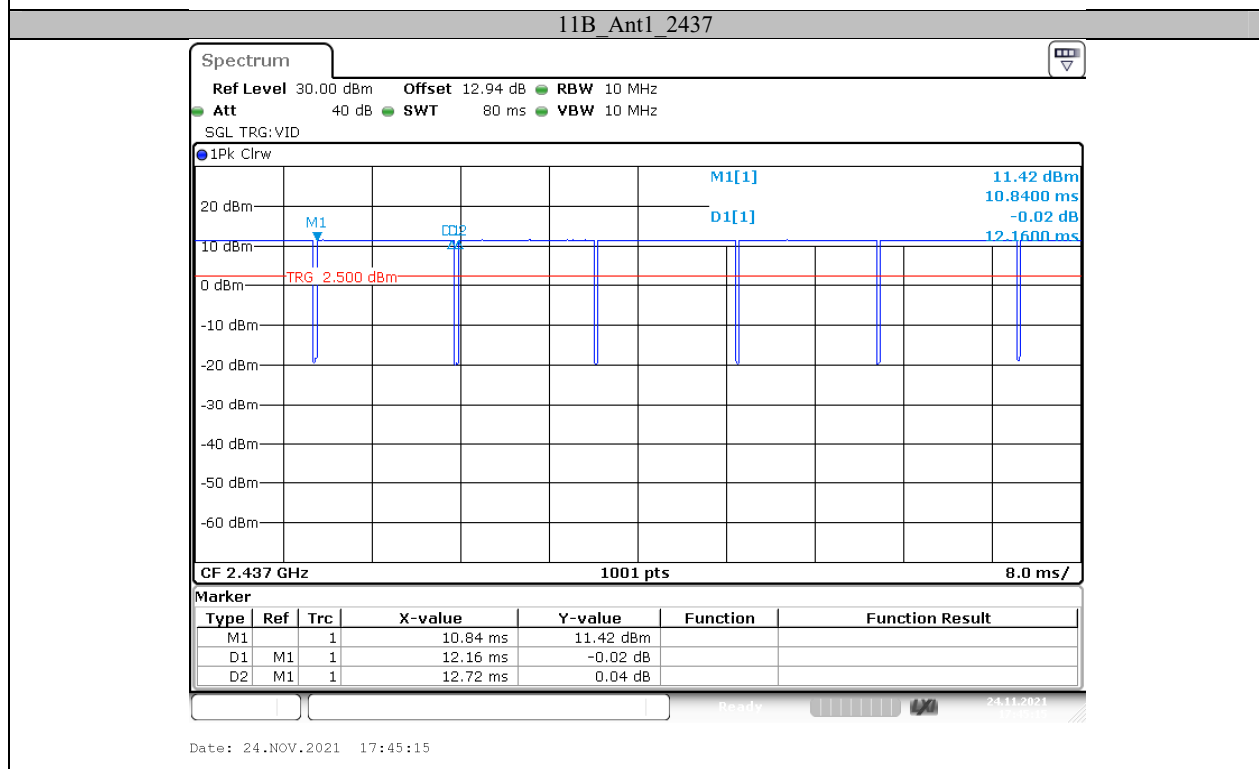
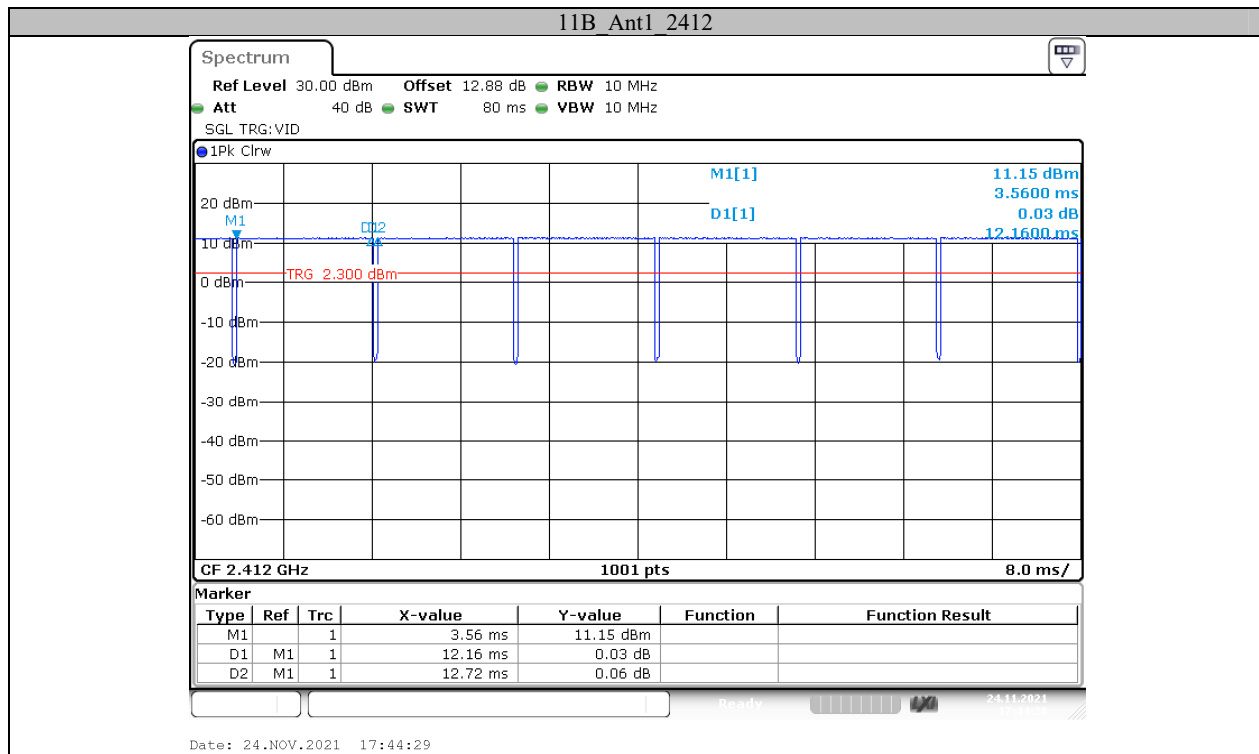

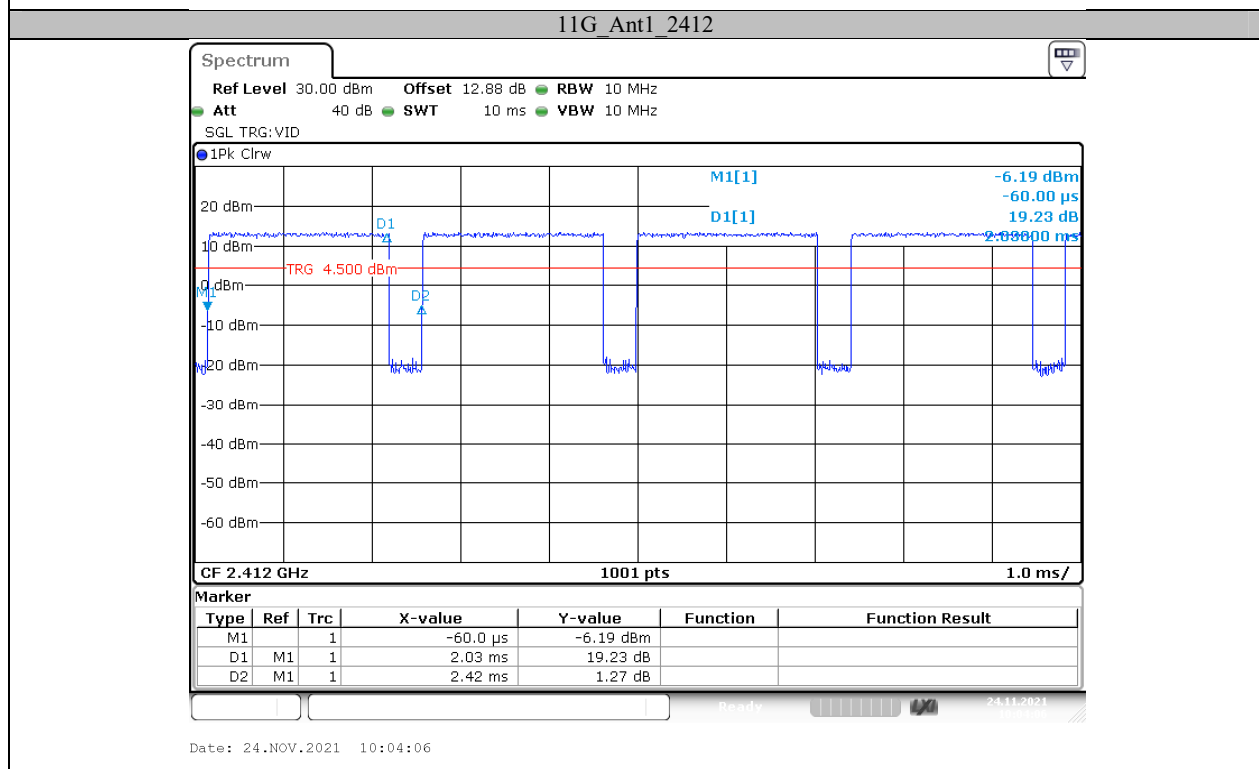
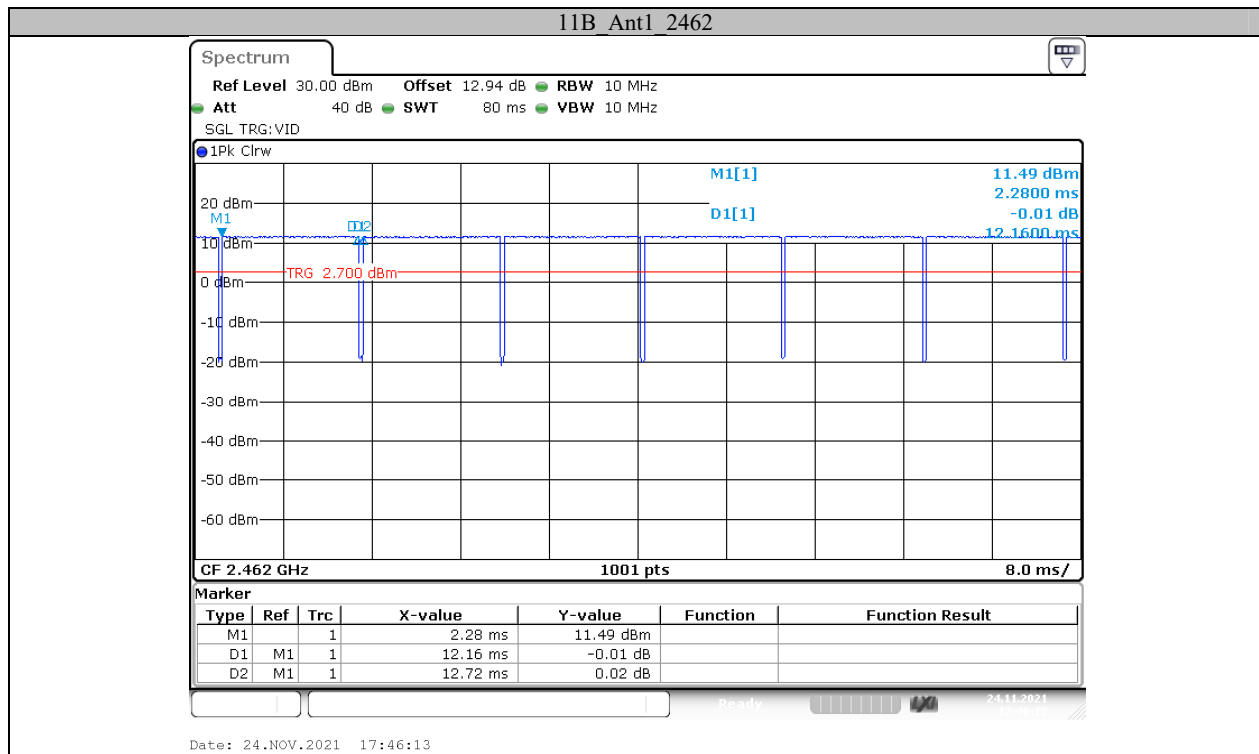

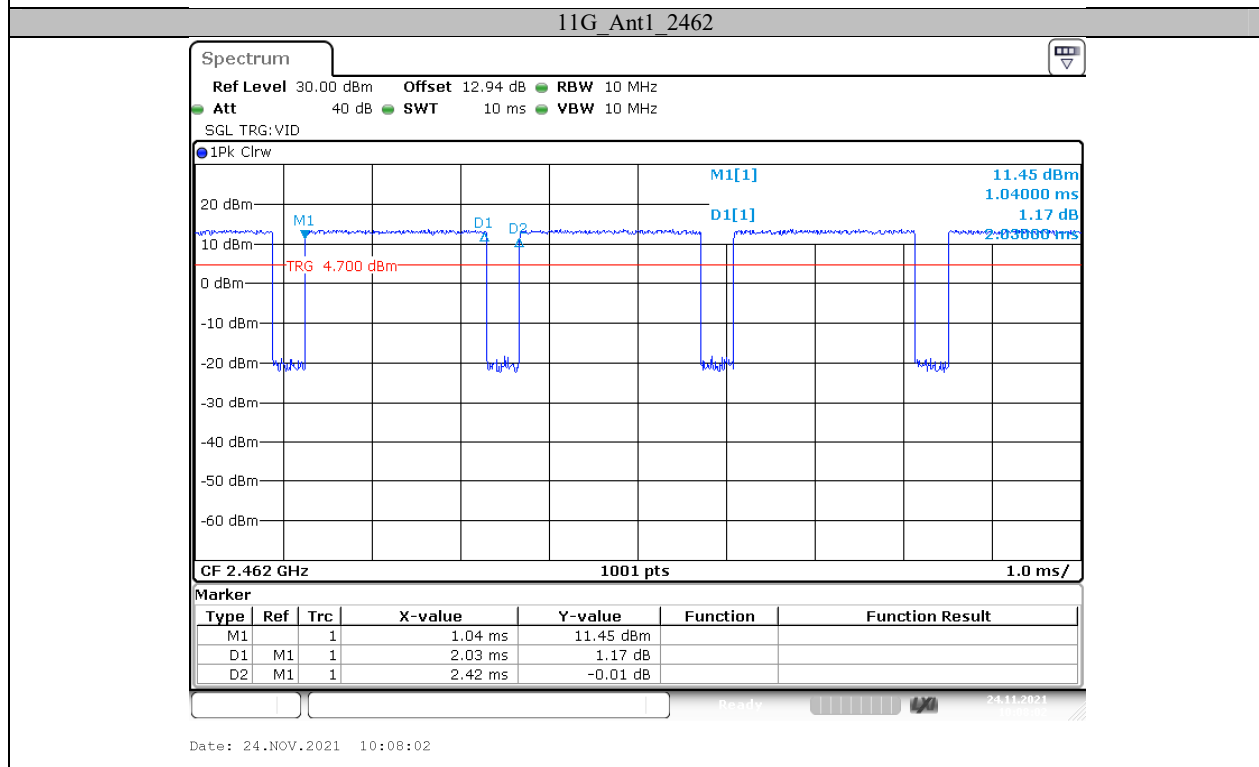
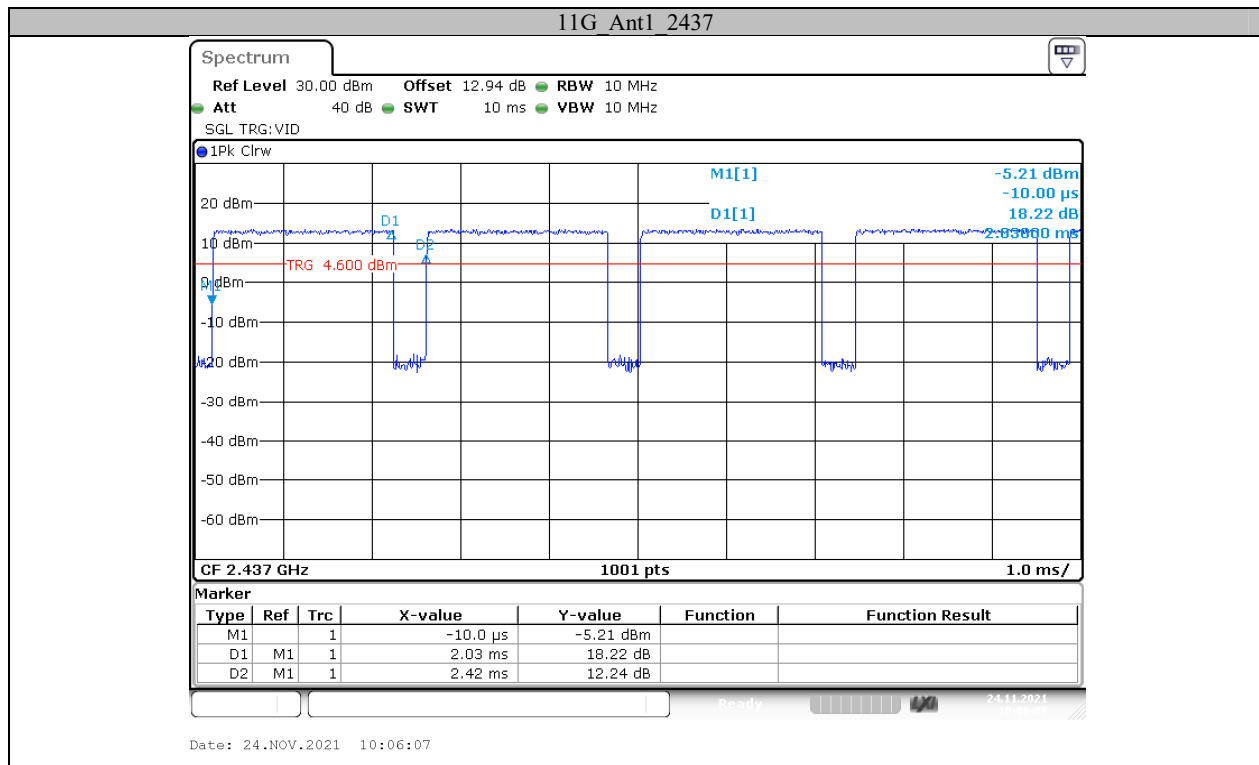

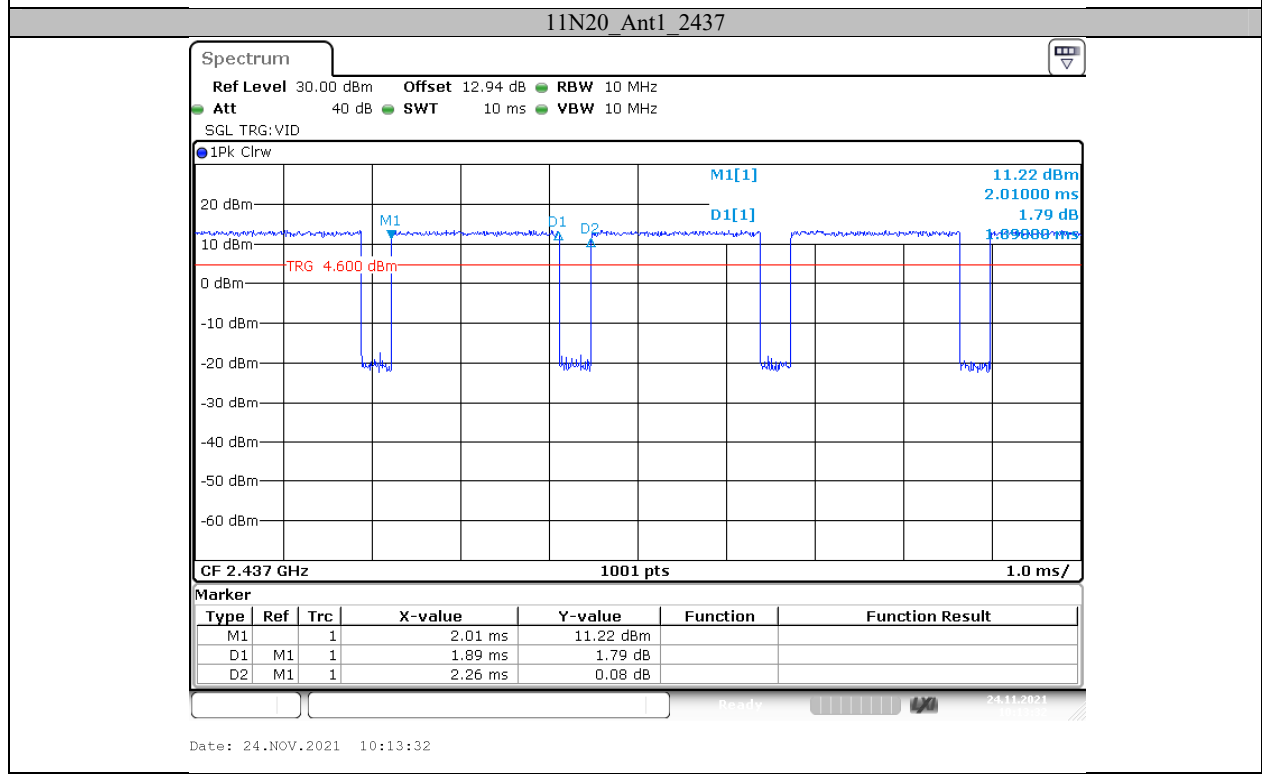
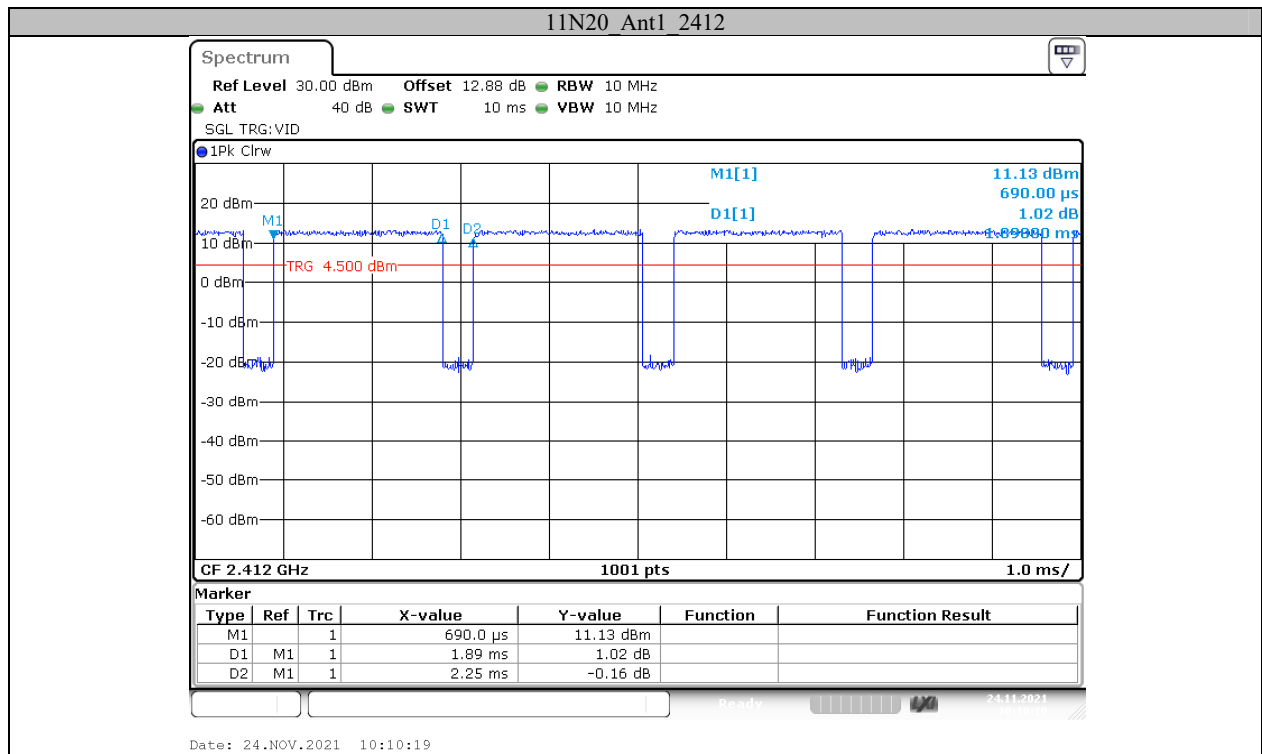

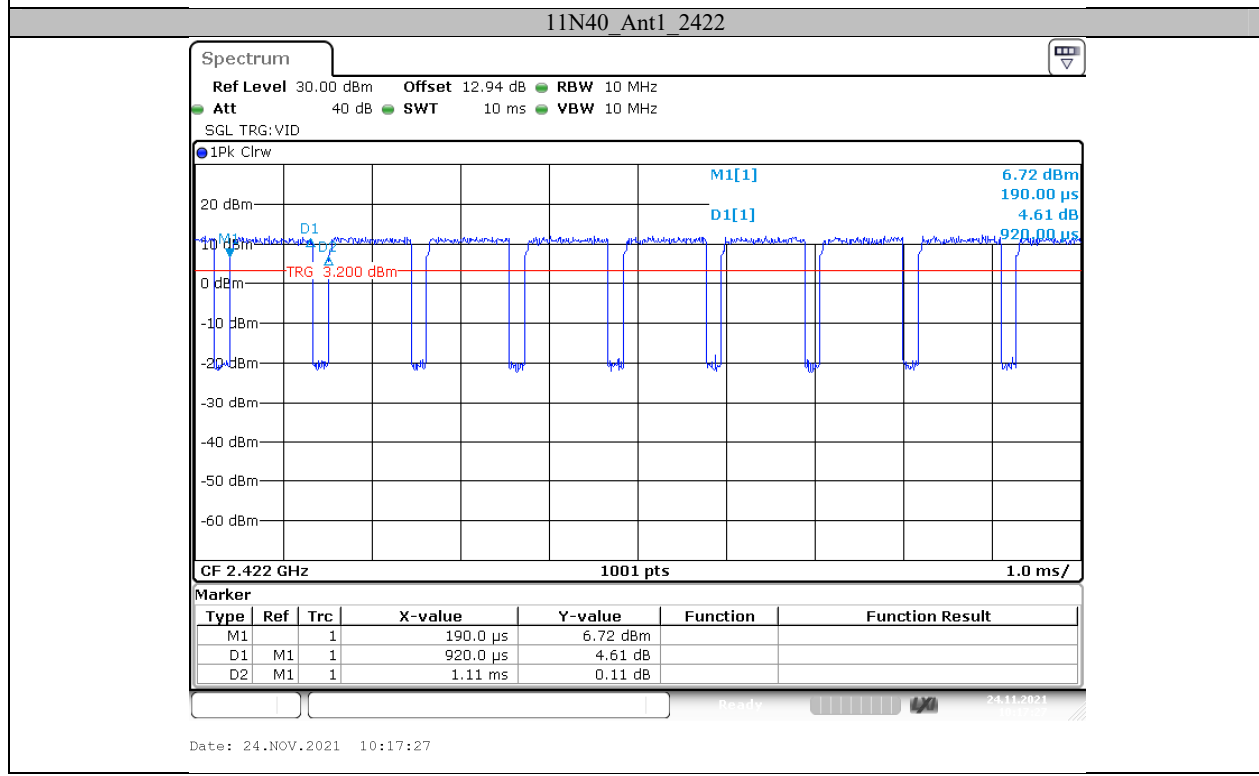
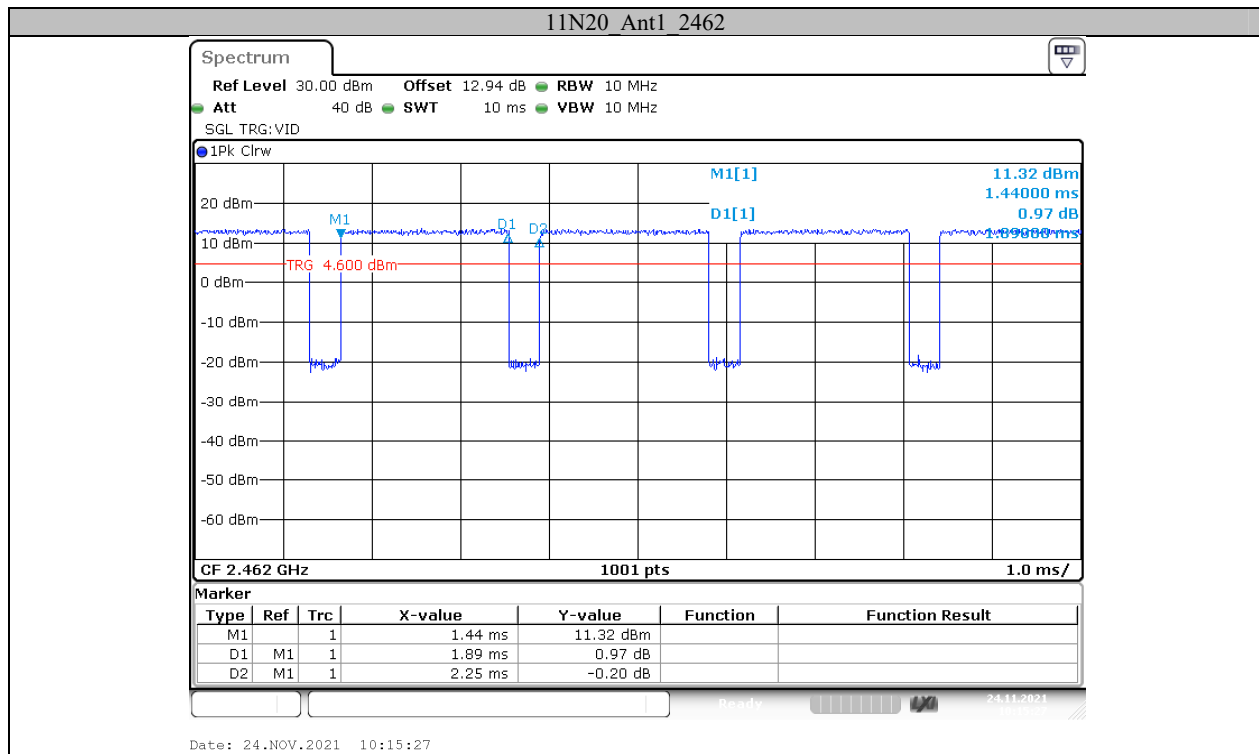

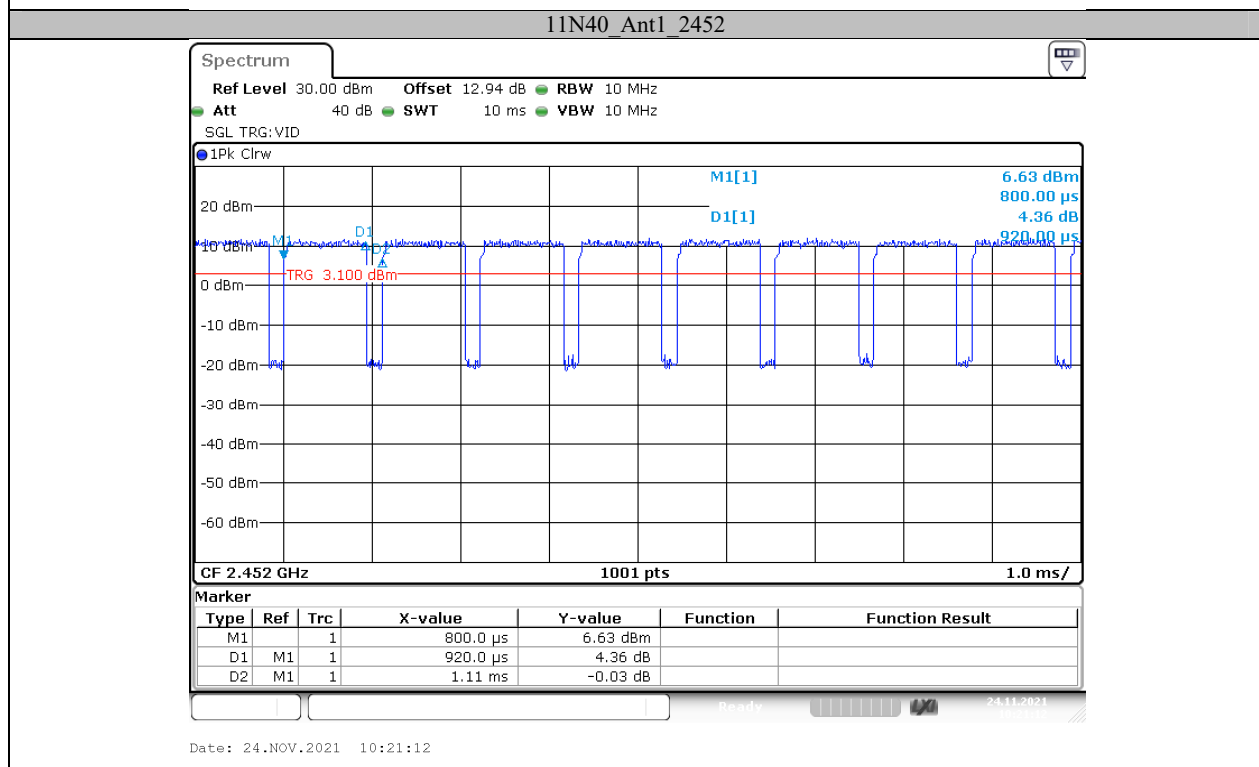
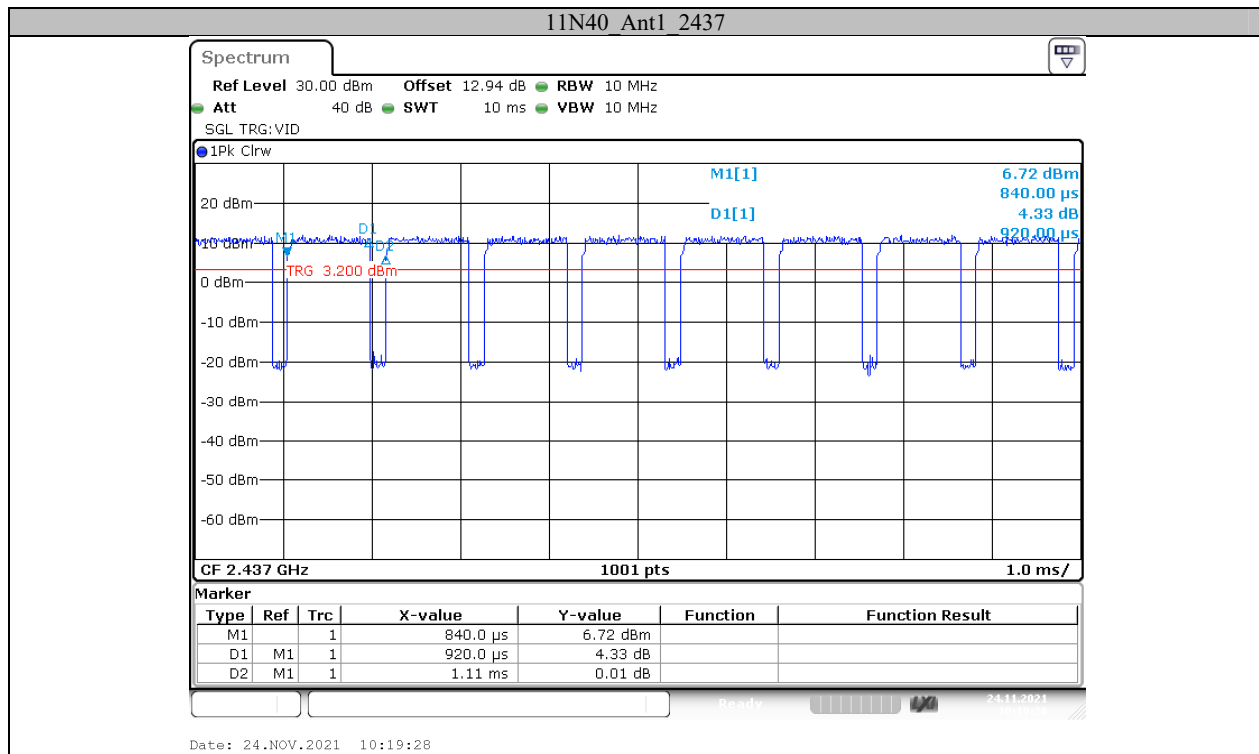

***** END OF REPORT *****