

INFRAY OUTDOOR

RICO MICRO V2 SERIES

Multi-function Thermal Imager



WARNING! ITAR REQUIREMENTS

These products may be subject to export and foreign trade control laws of the United States and may not be exported without prior approval of the U.S. Department of State. Learn more at irayusa.com/ITAR.

FCC ID: 2AY3N-MICRO

This device complies with part 15 of the FCC Rules. Operation is subject to the following two conditions: (1) This device may not cause harmful interference, and (2) this device must accept any interference received, including interference that may cause undesired operation.

CAUTION: Changes or modifications not expressly approved by iRayUSA could void the user's authority to operate the equipment.

NOTE: This equipment has been tested and found to comply with the limits for a Class B digital device, pursuant to part 15 of the FCC Rules. These limits are designed to provide reasonable protection against harmful interference in a residential installation. This equipment generates, uses and can radiate radio frequency energy and, if not installed and used in accordance with the instructions, may cause harmful interference to radio communications. However, there is no guarantee that interference will not occur in a particular installation. If this equipment does cause harmful interference to radio or television reception, which can be determined by turning the equipment off and on, the user is encouraged to try to correct the interference by one or more of the following measures:

- Reorient or relocate the receiving antenna.
- Increase the separation between the equipment and receiver.
- Connect the equipment into an outlet on a circuit different from that to which the receiver is connected.
- Consult the dealer or an experienced radio/TV technician for help.

This device was tested for typical body-supported operations and use. Third-party belt-clips, holsters, and similar accessories used by this device should not contain any metallic components. Body accessories that do not meet these requirements may not comply with RF exposure requirements and should be avoided. Use only the supplied or an approved antenna.

This device complies with RF exposure requirements for general population exposure conditions. SAR test distance is 0cm.

WARNING: CHOKING HAZARD

Children under 3 years old can choke or suffocate on small parts of this product. This product is not a toy; keep out of reach of children.

TABLE OF CONTENTS

| | |
|---|----|
| 1. Overview | 2 |
| 2. Features | 2 |
| 3. Tech Specs | 3 |
| 4. Accessories | 4 |
| 5. Components and Controls | 5 |
| 6. Description of Control Buttons & Shortcuts ... | 6 |
| 7. Quick Start Guide | 8 |
| 8. Charging the Batteries | 9 |
| 9. Inserting a Battery | 10 |
| 10. Removing a Battery | 10 |
| 11. Battery Safety Precautions | 10 |
| 12. Mounting the MICRO V2 | 11 |
| 13. Selecting a Working Mode | 15 |
| 14. Operating Instructions | 16 |
| 15. Zeroing the MICRO V2 | 20 |
| 16. Non-uniformity Correction | 21 |
| 17. Photography and Video Recording | 22 |
| 18. Accessing Internal Memory | 24 |
| 19. Using the InfiRay Outdoor 2.0 App | 25 |
| 20. Digital Zoom | 26 |
| 21. Bluetooth remote control | 26 |
| 22. Adjusting Screen Position | 26 |
| 23. Menu Options & Descriptions | 28 |
| 24. Basic Inspection | 44 |
| 25. Basic Maintenance | 45 |
| 26. Warranty | 45 |
| 27. General Troubleshooting | 46 |
| 28. Notes | 47 |

1. OVERVIEW

Building upon the success of the original RICO MICRO series we have made several improvements and upgrades to give the RH25 and RL25 even more value. These models now feature a faster 60hz refresh rate, $\leq 15\text{mK}$ sensitivity, larger 1440x1080 display, better eye relief, recoil-activated video, and bluetooth remote functionality. Both models can be used as a handheld scanner, a dedicated scope, a clip-on, or mounted to a helmet.

2. FEATURES

- High-performance 12 μm InfiRay Micro II thermal sensor
- High-resolution AMOLED display
- Maximum $\leq 15\text{ mK}$ sensitivity
- 1x to 4x digital zoom magnification
- 1375 yard detection range
- 60Hz image refresh rate
- Recoil activated video
- 64 GB internal storage
- Record up to 1600 images and 40 hours of video
- Built-in Wi-Fi module
- Mobile device App compatible
- Built-in microphone
- Digital compass
- Multiple zero profiles and ranges
- Multiple reticle types and color options
- Defective pixel correction
- Extended eye relief
- Cold and warm image temperature options
- Lightweight and compact design

3. TECH SPECS

| RICO MICRO SERIES | RL25 V2 | RH25 V2 |
|-------------------------------|--|----------------------|
| SENSOR | | |
| Resolution | 384x288 | 640x480 |
| Pixel Size | 12 μm | |
| Frame Rate | 60Hz | |
| Image Processing | MATRIX III | |
| Sensor Sensitivity | $\leq 18\text{ mK}$ | $\leq 15\text{ mK}$ |
| Core | InfiRay Micro II 384 | InfiRay Micro II 640 |
| OPTICS | | |
| Objective Lens | 25 mm f/1.0 | |
| Magnification | 2.28x | 1.36x |
| Digital Zoom | 4x | |
| Field of View | 10.5° x 7.9° | 17.5° x 13.1° |
| Detection Range | 1375 Yards | |
| Display Type | AMOLED | |
| Display Resolution | 1440x1080 | |
| Color Palettes | White Hot, Black Hot, Red Hot, Color | |
| Reticle Types | 7 | |
| Reticle Colors | Black, White, Red, Green | |
| Mounting System | MUM Rail, Picatinny MIL-STD-1913 Rail, PICTAIL (Optional/Not Included) | |
| Working Modes | Standalone, Handheld, Helmet, Clip-on | |
| P.I.P | No | |
| Rangefinder | No | |
| Eye Relief | 45 mm | |
| Diopter Range | -5 to +2 | |
| ELECTRONICS | | |
| Onboard Recording | Video, Recoil-Activated Video, and Image | |
| Onboard Storage | 64 GB | |
| Wireless Connectivity | Video and Image via App. | |
| Data Connector | USB-C | |
| Power Supply | 18650 Batteries x2 (6.5+ Hours Each) | |
| Start Up Time | ≤ 5 Seconds, Instant from Standby | |
| PHYSICAL | | |
| Size | 4.52" x 2.55" x 1.88" | |
| Weight | 11.3 Oz | |
| Housing Color | Black | Cerakote TAN H-235 |
| ENVIRONMENTAL/WARRANTY | | |
| Warranty | 5 Years | |
| Housing Material | Magnesium | |
| Ingress Protection | IP67 | |
| Operation Temperature | -4°F~122°F | |
| Max. Recoil | 1000 g/s ² (300 Win./7mm Mag) | |

4. ACCESSORIES

The RICO MICRO V2 Series ships with everything you need to get out and hunt. The included items are as follows:

- 25mm Objective Lens Cap
- Eyeguards ×2
- OEM Rifle Mount (1.93 inch)
- M4×8mm Flat Head Screws (2)
- M4×6mm Socket Head Screws (2)
- 2.5mm and 3mm Hex Keys
- Lens Lever
- Bluetooth Remote
- 18650 Batteries ×2
- 18650 Battery Charger
- Battery Cap for Short 18650 Battery
- USB-C Cable
- USB Power Adapter
- Hard Case
- Lens Cloth
- User Manual



Various replacement accessories are available for purchase. Contact us at 800-769-7125 or irayusa.com/support.

5. COMPONENTS AND CONTROLS

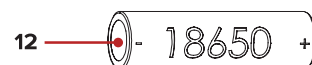
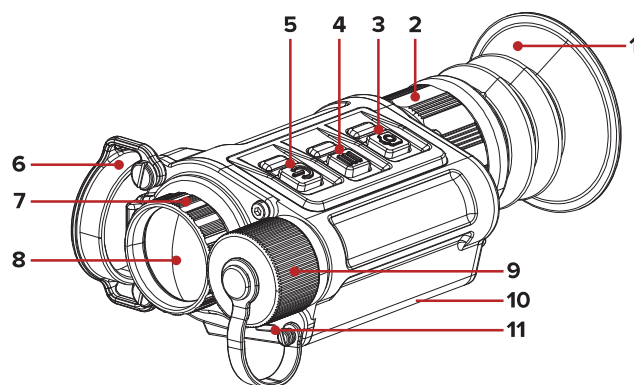



- 1 Eyeguard
- 2 Eyepiece/diopter adjustment ring
- 3 Photo button
- 4 Menu button
- 5 Power button
- 6 Objective lens cap
- 7 Objective lens focus ring
- 8 Objective lens
- 9 Battery cover / compartment
- 10 Mount interface
- 11 USB-C port
- 12 18650 battery



6. DESCRIPTION OF CONTROL BUTTONS AND SHORTCUTS

| Power Button  | | |
|---|---|---|
| Current Screen / Menu or Device Status | Short Press | Long Press |
| Device off | — | Power on the device |
| Home screen (in standalone/handheld mode) | Adjust the digital zoom level | Turn off the device /enter standby mode |
| Home screen (in helmet mode) | Perform a non-uniformity correction (NUC) | Turn off the device /enter standby mode |
| Any menu or full-screen interface | Move through the menu options | — |
| Full-screen interfaces (defective pixel, reticle zeroing, and screen position in helmet and clip-on mode) | Move the cursor 1 pixel in the negative direction | Move the cursor 10 pixels in the negative direction |

| Menu Button  | | |
|---|--------------------|--------------------------------------|
| Current Screen / Menu | Short Press | Long Press |
| Home screen | Enter the menu | Change the working mode |
| Main menu | Select a menu item | Save and return to the previous menu |

| Power + Menu Button  +  | | |
|---|-------------|---------------------------------------|
| Current Screen / Menu | Short Press | Long Press |
| Home screen (in helmet or clip-on mode) | — | Adjust the X/Y position of the screen |

| Photo Button  | | |
|---|---|---|
| Current Screen / Menu | Short Press | Long Press |
| Home screen | Take a photo | Start / stop recording video |
| Any menu or full-screen interface | Move through the menu options | — |
| Full-screen interfaces (defective pixel, reticle zeroing, and screen position in helmet and clip-on mode) | Move the cursor 1 pixel in the positive direction | Move the cursor 10 pixels in the positive direction |

| Photo + Menu Button  +  | | |
|---|---|---|
| Current Screen / Menu | Short Press | Long Press |
| Home screen | Perform a shuttered non-uniformity correction (NUC) | Perform a shutterless non-uniformity correction (NUC) |

7. QUICK START GUIDE

Step 1: Unbox and Setup the RICO MICRO V2

1. Compare the box contents to the accessories list and examine each for any shipping damage. See **Accessories** on page 4.
2. Check the lens to ensure there are no smudges or dirt present. Clean with the included lens cloth, as needed.
3. Charge the batteries before using the MICRO V2 for the first time. See **Charging the Batteries** on page 9.
4. Open the battery cover (9) and install a battery (12). See **Inserting a Battery** on page 10.
5. Install the desired eyeguard (1). The longer eyeguard is recommended for clip-on and standalone use and the shorter is recommended for helmet and handheld use.
6. Mount the MICRO V2 to the weapon or helmet. See **Mounting the MICRO V2** on page 11.

Step 2: Turn On the MICRO V2 & Adjust the Focus

1. Open the lens cap (6).
2. Long press the **Power** (4) **Button** for 3 seconds to power on the MICRO V2. The Infray Outdoor logo will appear.
3. Rotate the diopter adjustment ring (2) of the eyepiece until the interface icons are clear.

WARNING: Do not point the objective lens toward intense energy sources, such as the sun. This may render the electronic components inoperative. The warranty does not cover damage caused by improper operation.

Step 4: Adjust the Device Settings

1. From the home screen, short press the **Power** (4) **Button** to adjust the digital zoom level to 1x, 2x, or 4x. Digital zoom is disabled in helmet and clip-on modes. See **Digital Zoom** on page 26.
2. Long press the **Menu** (3) **Button** to enter the main menu (see **Main Menu Options and Descriptions** on page 28 for detailed instructions) to adjust the following settings:
 - a. Set the working mode to standalone/handheld, helmet, or clip-on.
 - b. Set the color palette to white hot, black hot, red hot, or color.
 - c. Select an image brightness level, from 1–10.
 - d. Select an image contrast level, from 1–10.
 - e. Select a screen brightness level, from 1–10.

- f. Set the non-uniformity correction (NUC) mode to automatic or manual.
- g. Set the units of measure to meters or yards.
- h. Calibrate the digital compass.
- i. Set the date and time.

Step 5: Set Up and Zero the Reticle (Optional)

NOTE: The reticle is only enabled in standalone/handheld working mode. To adjust the following settings, ensure standalone/handheld mode is selected.

1. Long press the **Menu** (3) **Button** to enter the main menu (see **Main Menu Options and Descriptions** on page 28 for detailed instructions) to adjust the reticle settings.
 - a. Select the zeroing profile.
 - b. Set the reticle style, from 0–7.
 - c. Set the reticle brightness, from 0–6.
 - d. Set the reticle color to white, black, red, and green.
 - e. Select the zero distance.
2. Zero the reticle. See **Zeroing the MICRO V2** on page 20.

8. CHARGING THE BATTERIES

The RICO MICRO V2 Series comes with two rechargeable 18650 li-ion batteries, a battery charger, and a USB charging adapter. Ensure the battery is fully charged before using the MICRO V2 for the first time.

To charge the battery:

1. Insert the battery (12) into the battery charger according to the polarity markings on the inside of the charger.
2. While charging:
 - a. The three LEDs on the charger will flash, indicating the current charge level.
 - b. All three LEDs will remain lit when the battery is fully charged.
3. When fully charged, remove the battery from the charger. Do not overcharge.

NOTES:

- It takes about 2 hours to fully charge the battery. Each battery supports a run-time of approximately 6.5 hours. See **Battery Status** on page 19 for additional battery information.

- Charge the battery before it reaches <5% (the battery icon in the status bar will flash red) to avoid over-discharge and potential damage to the battery.

9. INSERTING A BATTERY

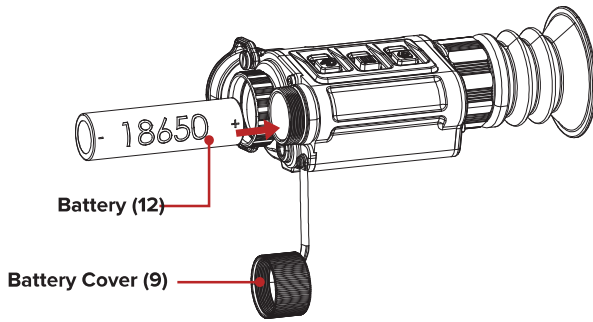

1. Remove the battery cover (9) by turning it counterclockwise.
2. Insert a 18650 battery (12) into the battery compartment per the polarity markings inside the compartment. The positive [+] battery terminal faces in and the negative [-] terminal faces out.
3. Replace the battery cover.

NOTE: To accommodate variations in 18650 battery length, two battery covers are included. If using a shorter 18650 battery than provided, please use the shorter cover to ensure reliable operation.

10. REMOVING A BATTERY

1. Ensure the MICRO V2 is powered off before removing the battery.
2. Remove the battery cover (9) by turning it counterclockwise. Then remove the battery.

11. BATTERY SAFETY PRECAUTIONS

WARNING: Only use the included battery charger to charge the batteries. Only use the battery charger with a standard USB adapter (5V–2A), as included in the package. Using any other type of adapter may lead to irreversible damage to the battery, adapter, or the MICRO V2. This damage will not be covered under warranty.

WARNINGS:

- Only use 18650 batteries to power the MICRO V2.
- Do not use a battery charger, power adapter, or USB cable that has been modified or damaged.
- Do not expose batteries to high temperatures or flames, and do not immerse in water.

- Do not leave batteries unattended while charging.
- Do not leave batteries in the charger for long periods after full charge is reached. Charging time should not exceed 24 hours.
- Keep batteries out of the reach of children and pets.
- The batteries are equipped with short-circuit protection; however, any situation that may cause short-circuiting should be avoided.
- Do not disassemble, modify, hit, or drop the batteries.
- Do not connect the batteries to any external device with an electrical current that exceeds permitted levels.
- Do not connect an external device with a current supply that exceeds a 3.0 USB port.
- Remove the battery and store it in the soft-sided case to protect it during transport.
- If a battery has been used, stored, or charged for a long time it can begin to deteriorate. Stop using and remove the battery immediately with any battery discoloration or deformation, overheating, strange odors, or other unusual states.

To maintain optimal battery capacity and service life:

- Avoid storing a fully charged or discharged battery for long periods. Partial charging of the battery is necessary if the battery will be stored for an extended period.
- If storing for a long time, remove the battery from the MICRO V2 and store both in a cool, dry location.
- Do not charge an extremely cold battery without bringing it into a warm environment. Let the battery warm up for 45 minutes before charging.
- Charge the battery at a temperature range from 30°F to 100°F; otherwise, the service life of the battery may be reduced.
- The recommended operating temperature range is -4°F to 122°F. Avoid using the battery above the maximum or below the minimum recommended temperature range as this may decrease the battery capacity or service life.

12. MOUNTING THE MICRO V2

Mounting on a Helmet

The RICO MICRO V2 Series can be mounted with MUM-14 style interface hardware (not included), or with the optional PICTAIL system.

NOTE: Torque all hardware to a maximum of 15 inch-pounds (in/lbs) unless noted otherwise. **Please note, torque is inch-pounds, NOT foot-pounds.** If you do not have a torque wrench, apply until snug. Do not overtighten. No threadlocker is required for proper use; but if you do decide to use a threadlocker, use only a small amount of low-strength LOCTITE 222.

MOUNTING WITH THE OPTIONAL PICTAIL SHOE

1. Install the optional PICTAIL shoe (IRAY-AC52) onto the mount interface (10) with the narrow end of the dovetail facing toward the eyepiece as shown below.

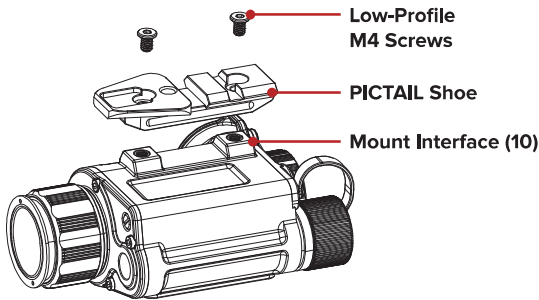

2. Screw in the low-profile M4 screws included with the PICTAIL shoe to 15 in/lbs.
3. Finish mounting to your helmet with compatible dovetail-style helmet interface hardware.

Mounting on a Weapon

The MICRO V2 may be used with (clip-on mode) or without (standalone/handheld mode) a rifle scope.

CAUTION: Before attempting to install your RICO MICRO V2 on a weapon, please guarantee that your firearm is unloaded, and the muzzle is pointed in a safe direction.

NOTE: Torque all hardware to a maximum of 15 inch-pounds (in/lbs) unless noted otherwise. **Please note, torque is inch-pounds, NOT foot-pounds.** If you do not have a torque wrench, apply until snug. Do not overtighten. No threadlocker is required for proper use; but if you do decide to use a threadlocker, use a small amount of low-strength LOCTITE 222.

MOUNTING WITH THE OEM RIFLE MOUNT

1. Install the OEM Rifle Mount onto the MICRO V2 mount interface (10) as shown below using the included two M4×8mm flat head screws.

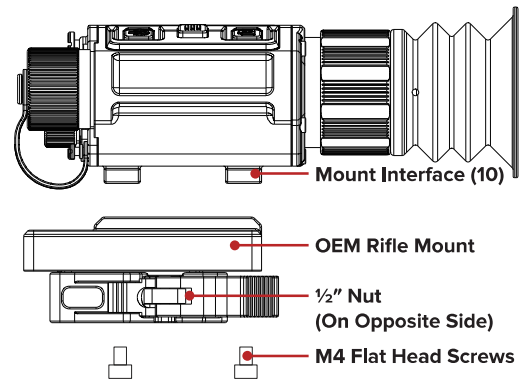

2. Torque the M4×8mm flat head screws until snug with the included hex key or to 15 in/lbs with a torque wrench.
3. Place the MICRO V2 on your weapon and adjust the tension of the 1/2-inch nut on the left side of the mount to 20 in/lbs.

NOTE: The OEM Rifle Mount is spring-loaded and features a built-in shock-reduction system. Front-to-back movement is a normal part of its design and will not impact accuracy.

Adjusting the Throw Lever Tension

If you cannot slide the mount onto the Picatinny rail because the throw lever is in the open position but the locking plate is not, or if the mount is not tight to the rail after the throw lever is closed, you may loosen or tighten the tension of the throw lever by adjusting the 1/2" nut.

1. Open the throw lever. This will cause the adjustment nut to protrude on the opposite side of the mount.
2. Use the prong-side of the included spanner tool to turn the adjustment nut clockwise to tighten, or counterclockwise to loosen, to achieve the correct amount of tension. You should not feel any tension on the locking lever when closing until it reaches a 45-degree angle. Do not overtighten.

MOUNTING WITH THE OPTIONAL PICTAIL SHOE AND MQD RIFLE MOUNT

The PICTAIL and MQD mount work in tandem to achieve an adjustable footprint on any standard Picatinny rail. In standalone mode, they produce over 4.5 inches of rear offset for proper eye relief. When reversed for use in clip-on mode, the MQD and PICTAIL shrink the rear offset to just 1.5 inches. In clip-on mode, the required forward rail space is just 4 rail slots in front of a day optic making the PICTAIL and MQD the perfect combination for shorter platforms like SBRs and pistols.

1. Install the PICTAIL shoe to the MICRO V2. See **Mounting with the Optional PICTAIL Shoe** on page 12.
2. Unlock the MQD mount by depressing the lock button on the tension lever and swinging 180° to the open position.
3. Install the MQD onto the rail of your weapon and move the lever to the locked position.
4. Finally, check the tension required to lock the tension lever. To adjust the tension:
 - a. Move the lever to the open position and push the lever toward the base. This will make the adjustment nut protrude on the opposite side of the base.
 - b. With the nut protruding, it may be turned to the right or the left to make the necessary adjustment. You will need NO tools for this step.

NOTE: The amount of tension you set will depend on your personal preference. You should not have to fight to open or close the tension lever; you should be able to move it easily with one hand.

NOTE: If tension adjustments are needed between the PICTAIL Shoe and the MQD, please follow the tension adjustment instructions on the previous page.

5. Mount the MICRO V2 to the MQD:
 - a. For standalone weapon optic use, mount the MICRO V2 to the MQD, oriented so that the MQD extends past the front of the objective lens as shown below.

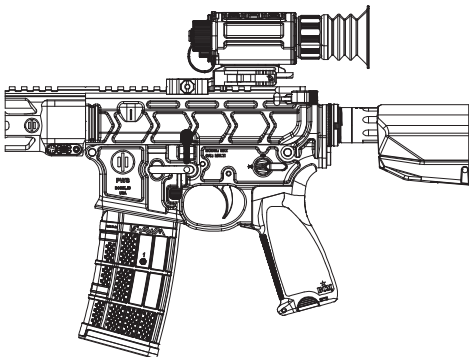

- b. For clip-on use, mount the MICRO V2 to the MQD, oriented so that the MQD does NOT extend past the front of the objective lens as shown below.

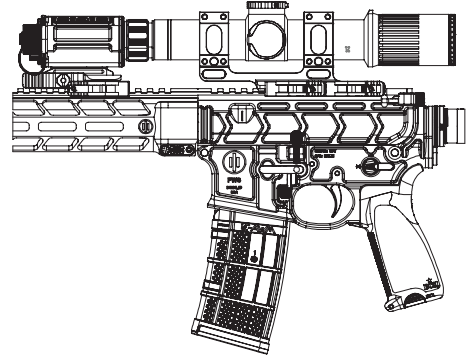

NOTE: We recommend going no higher than 6× on any rifle scope used in clip-on mode as image performance will become unsatisfactory.

13. SELECTING A WORKING MODE

The RICO MICRO V2 Series features three working modes: standalone/handheld, helmet, and clip-on. The MICRO V2 is in handheld mode when powered on for the first time. After the first use, the last-used working mode is the default.

To select standalone/handheld, helmet, or clip-on mode:

1. From the home screen, long press the **Menu**  **Button** to toggle through the working mode options OR select the desired mode in the menu. The icon for the selected mode appears on the left side of the status bar. See **Main Menu > Scene Mode** on page 29.

Standalone/Handheld Mode

- In standalone/handheld mode, the MICRO V2 can be used as a standalone weapon sight or it can be used as a handheld imager.
- Standalone/handheld mode is displayed at 1.36× and the reticle is displayed at all times.
- To use as a handheld imager, set the reticle type to 0 to turn off the reticle. See **Reticle Menu > Reticle Type** on page 31.

Helmet Mode

- Helmet mode allows the MICRO V2 display to be optimized for use on a helmet.
- The screen size is reduced to 80% to be in unity (1.1×). The X/Y position of the screen may be adjusted so that the center of the screen matches up with the rifle scope reticle. See **Adjusting Screen Position** on page 26.

- Helmet mode has its own abbreviated menu. See **Clip-on Mode Menu** on page 28.

NOTE: Only RH25 V2 has a 1.1x screen size helmet mode.

Clip-on Mode

- In clip-on mode, the MICRO V2 can be mounted in front of a rifle scope.
- The screen size is reduced to 70% to be in unity (1x). The X/Y position of the screen may be adjusted so that the center of the screen matches up with the rifle scope reticle. See **Adjusting Screen Position** on page 26.
- We recommend going no higher than 6x on any rifle scope used in clip-on mode as image performance will become unsatisfactory.
- Clip-on mode has its own abbreviated menu. See **Clip-on Mode Menu** on page 28.

14. OPERATING INSTRUCTIONS



WARNING!

Don't point the objective lens towards any intense energy sources, such as laser radiation or the sun. This may render the electronic components inoperative. The warranty does not cover damage caused by improper operation.

Shortcut Button Combinations



The MICRO V2 is operated by three control buttons. The control buttons can be used to perform shortcut operations from the home screen, as well as in the menu and full-screen interfaces. See **Description of Control Buttons and Shortcuts** on page 6 for shortcut button details.

Powering On

1. Open the lens cap (6).
2. Long press the **Power**  **Button** for 3 seconds to power on the MICRO V2. The Infrared Outdoor logo will appear.
3. To determine the current battery charge, check the battery status  icon and battery charge percentage in the status bar.

Powering Off and Entering Standby

To manually shut down the MICRO V2:

1. Long press the **Power**  **Button** from the home screen.
2. The shutdown screen will open showing a 3-second countdown.
3. Continue holding the **Power**  **Button** until the 3-second countdown completes.

4. "Data saving..." will appear on the screen and the MICRO V2 will shut down automatically.



NOTES:

- Releasing the Power button before the countdown completes will cancel the shutdown process and the imager will enter standby mode. Short press the Power button to exit standby mode.
- The device will shut down automatically after 3 hours of inactivity.
- After turning the device off, wait at least 20 seconds before powering it back on again.

WARNING: If using an external power supply, do not remove the power supply when saving data, as the data may not be saved.

STANDBY MODE

Standby mode may be activated to conserve battery life.

1. Long press the **Power**  **Button** from the home screen. The shutdown screen will open showing a 3-second countdown.
2. Release the **Power**  **Button** before the 3-second countdown completes to enter standby mode.
3. Short press the **Power**  **Button** to exit standby mode.

Adjusting the Focus

ADJUSTING THE DIOPTR/ EYEPIECE

1. Rotate the eyepiece diopter adjustment ring (2) at the rear of the rifle scope right or left until the user interface is clear.
2. Look closely to ensure all icons, the status bar, and the reticle appear sharp and in focus. No additional diopter adjustments are required unless the user wishes to make changes.

NOTES:

- After the initial adjustment, there is no need to rotate the eyepiece adjustment ring (2) for long distances or other conditions.
- If necessary during standard use, the objective lens focus ring (7) may be rotated to adjust fine focus on the target object being observed. See **Focusing the Objective Lens** below.

FOCUSING THE OBJECTIVE LENS

To adjust the focus on the target object:









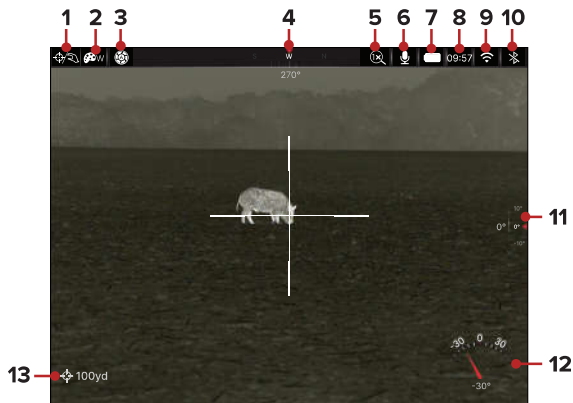



1. Rotate the objective lens focus ring (7) left or right to adjust fine focus.

NOTE: Re-adjusting the focus will be necessary if the distance to the target changes.

Status Bar Overview







The status bars at the top and sides of the screen show information on the operating status of the RICO MICRO V2.



- 1 **Working Mode:** Shows the selected mode, standalone/handheld, helmet, or clip-on.
- 2 **Color Palette:** Shows the current color palette, white hot , black hot , red hot , or color .
- 3 **Non-Uniformity Correction (NUC) Mode:** Shows the icon for the selected non-uniformity correction (NUC) mode, automatic  or manual . When automatic mode is selected, a countdown timer will appear when 5 seconds remain until a NUC.
- 4 **Digital Compass:** Displays when the compass is turned on.
- 5 **Digital Zoom:** Shows the selected digital zoom level, 1x, 2x, or 4x.
- 6 **Microphone:** Shows the microphone status, on  or off .
- 7 **Battery:** Five bars show the current charge level.
- 8 **Clock:** Shows the current time in 24-hour format.
- 9 **Wi-Fi:** Shows the Wi-Fi status, on  or off .
- 10 **Bluetooth:** Shows the Bluetooth status, on  or off .
- 11 **Pitch Angle:** Displays when the compass is turned on.
- 12 **Tilt Angle:** Displays when the compass is turned on.
- 13 **Zero Distance:** Shows the selected zero distance.





BATTERY STATUS

Five bars in the battery icon indicate the current battery status.

| ICON | BARS / STATUS | BATTERY LEVEL |
|---|----------------------|-------------------------|
|  | 5 White Bars | 80–100% |
|  | 4 White Bars | 60–79% |
|  | 3 White Bars | 40–59% |
|  | 2 White Bars | 20–39% |
|  | 1 White Bar | <20% |
|  | Flashing Red Battery | <5%, charge immediately |

Navigating the Menu











- From the home screen, short press the **Menu**  Button to enter the main menu.
- Short press the **Photo**  Button to move right and the **Power**  Button to move left through the menu options.
- A blue icon indicates the cursor position in the menu.
- Short press the **Menu**  Button to select.
- Long press the **Menu**  Button to save any changes and return to the previous menu or screen.
- After 15 seconds of inactivity, the menu will automatically close and the interface returns to the home screen.
- When exiting the menu, the cursor location is stored for a single working session (i.e. until the MICRO V2 is turned off). After restarting the MICRO V2, the cursor will return to the first menu item.

15. ZEROING THE MICRO V2

The RICO MICRO V2 Series must be in standalone/handheld mode (reticle enabled) to begin zeroing. See **Selecting a Working Mode** on page 15.

To zero the MICRO V2:

1. Set a suitable target at the desired zero distance.
2. Confirm that the rifle is empty, safe, and pointed in a safe direction, with no ammunition near the weapon.
3. Adjust the image and device settings following the steps in the **Quick Start Guide** on page 8.
4. Select the zeroing profile, A, B, or C.
5. Based on the distance to the target you wish to zero, select OR customize one of the default zero distances to match. The MICRO V2 supports custom zeroing distances of 1 to 999 meters or 1 to 999 yards.
6. Ensure a stable platform and natural shooting position is achieved behind the rifle.
7. Load ammunition, aim, and take one good shot at the target.
8. Make your rifle safe and observe the location of impact on the target.
9. If the point of impact does not match the point of aim (the center of the reticle), adjust the X/Y position of the reticle.
10. In the submenu for the selected zero distance, center the reticle on the aiming point, and long press the **Photo**  and **Menu**  **Buttons** to freeze the image. The freeze  icon will appear below the X/Y coordinates.
11. Select the axis (X or Y) along which to move the reticle:
 - a. Short press the **Photo**  or **Power**  **Button** to move between X and Y.
 - b. Short press the **Menu**  **Button** to select or select the axis.
12. Adjust the X/Y position of the reticle until the reticle matches the point of impact.
 - a. Use the **Photo**  **Button** to move in the positive direction: X= Right and Y= Up.
 - b. Use the **Power**  **Button** to move in the negative direction: X= Left and Y= Down.
13. Long press the **Menu**  **Button** to save the reticle position for both axes and return to the home screen.
14. Take a confirmation shot—the point of impact should now match the point of aim. If not, adjust the X/Y position of the reticle again.

For detailed Zeroing instructions, please see **Reticle Menu > Reticle Zeroing** on page 33.

16. NON-UNIFORMITY CORRECTION

A non-uniformity correction (NUC) allows a thermal imager's sensors to correct its pixels and eliminate any image defects caused by pixel drift. A NUC will be performed automatically each time the RICO MICRO V2 is powered on.

The RICO MICRO V2 Series has two NUC modes, automatic (**A**) and manual (**M**). See **Advanced Menu > Calibration** on page 38. In either mode, the user may choose to manually perform a NUC (shuttered or shutterless) at any time.

Automatic Mode



In automatic mode (**A**), the MICRO V2 will perform a NUC automatically according to the internal software algorithm. A countdown timer will appear when 5 seconds remain until a NUC. There is no need to close the objective lens cap (**6**) as the MICRO V2's internal shutter covers the sensor.

Manual Mode

In manual mode, the user independently determines the need to perform a shuttered or shutterless NUC based on the quality of the observed image.



Performing a Shuttered NUC

A shuttered NUC may be performed at any time while in manual or automatic mode. It is not necessary to close the objective lens cap (**6**) during a shuttered NUC, as the internal shutter covers the sensor.

1. From the home screen, short press the **Photo**  and **Menu**  **Buttons** at the same time.
2. The internal shutter will cover the sensor and a shuttered non-uniformity correction (NUC) will be performed instantly.

Performing a Shutterless NUC

A shutterless NUC may be performed at any time while in manual or automatic mode. A shutterless NUC uses less power than a shuttered NUC because it does not use the imager shutter to cover the sensor; instead, the user must close the lens cap (**6**).

1. Close the objective lens cap.
2. From the home screen, long press the **Photo**  and **Menu**  **Buttons** at the same time.
3. A prompt to close the lens cap appears onscreen. The shutterless NUC starts after about 2 seconds.

NOTE: If the lens is not properly covered, a temporary “image burn” will remain in the image until the next non-uniformity correction. This “image burn” is temporary and is not a defect or sign of permanent damage.



17. PHOTOGRAPHY AND VIDEO RECORDING

The MICRO V2 is equipped with video recording and image capture. All images and videos are automatically saved on the MICRO V2's internal 64 GB memory storage.

NOTE: Photo and video files are named with the time and date; therefore it is recommended to set the date and time before using the photo and video functions. See **Advanced Menu > Date and Time** on page 42. Alternatively, the date and time may be synchronized in the InfiRay Outdoor 2.0 App.

Photography





To take a photo:

1. From the home screen, short press the **Photo ** Button.
2. The camera icon  appears briefly on the left side of the screen to indicate a photo was taken.



Video Recording

To record video:

1. Turn on the microphone in the menu. See **Advanced Menu > Microphone** on page 36.
2. From the home screen, long press the **Photo ** Button to begin a video recording.
3. When the video starts, the video icon  and recording timer, in HH:MM:SS (hour: minute: second) format, will appear on the left side of the screen.
4. When recording, short press the **Photo ** to take a photo.
5. Long press the **Photo ** Button to stop and save the video recording.



Recoil Activated Video Recording

When recoil activated video is turned on in the menu, a video is automatically recorded when a shot is taken. The RICO MICRO V2 will record 20 seconds before the shot and 20 seconds after the shot.

The recoil activated video  icon and 20-second timer will appear on the left side of the screen. See **Advanced Menu > Recoil Activated Video** on page 37 for instructions.

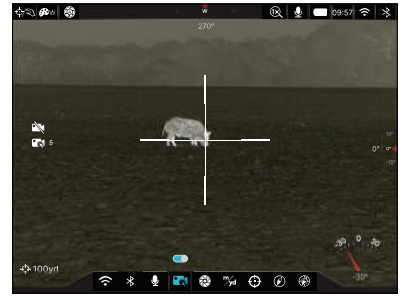

NOTES:

- When multiple shots are taken within the same 30-second period, only one video will be recorded.
- When recoil activated video recording is turned on, standard video recording is unavailable.

Video and Photography Notes

- You may enter and use the menu as normal during video recording. The user interface (the status bar, icons, and menu) is not captured in the recorded video and photo files.
- Recorded photos and videos are saved to the memory card:
 - Photos are saved as IMG_YYYYMMDDHHMMSS.jpg.
 - Videos are saved as VID_YYYYMMDDHHMMSS.mp4.
 - RAV videos are saved as RAV_YYYYMMDDHHMMSS.mp4.
 - YYYYMMDDHHMMSS is year, month, day, hour, minute, and second.
- The maximum duration of a recorded video file is 5 minutes. After this time, video recording will begin a new file automatically.
- The number of recorded files is limited only by the capacity of the internal memory.
- Regularly check the available memory storage space and move video footage and images to other storage media to free up space on the memory card.

18. ACCESSING INTERNAL MEMORY

When the RICO MICRO V2 Series is turned on and connected to a computer via the included data cable, it is recognized by the computer as a flash memory (USB) drive. This allows the user to access the saved multimedia files and copy or delete any desired files.

To access the internal memory:

1. Turn on the MICRO V2.
2. Plug the USB-C end of the data cable into the USB-C port on the imager.
3. Plug the USB end of the cable into a computer or laptop.
4. The MICRO V2 will connect automatically to the computer.

NOTE: Photography and video recording are disabled when the MICRO V2 is connected to a computer.

To Access Files On Windows

1. Double-click the **This PC icon** on your computer's desktop.
2. Double-click the unnamed USB drive in the Devices and Drives list to open it. The USB drive contains folders named by date "YYYYMMDD". The photos and videos are stored in the folder corresponding to the date.
Photos are named starting with **IMG**.
Videos are named starting with **VID**.
Recoil activated videos are named starting with **RAV**.
3. Select the desired files or folders to copy or delete.
4. When done, disconnect the data cable.

NOTE: Please make sure to copy the photos and videos to your computer before opening them. Otherwise reconnect the MICRO V2 to the computer and copy the files or folder to your computer.

To Access Files On Mac

1. Double-click the untitled USB drive on your computer's desktop. The USB drive contains folders named by date "YYYYMMDD".
2. Select the desired files or folders to copy or delete.
3. When done, right-click the drive on your desktop and eject it.
4. Then, disconnect the data cable.

19. USING THE INFIRAY OUTDOOR 2.0 APP

The RICO MICRO V2 Series can be operated using the InfiRay Outdoor 2.0 App when the thermal imager is connected to a smartphone or tablet via Wi-Fi.



1. Download the App for free and install it on your smartphone or tablet:
 - a. Scan one of the QR codes above to download the InfiRay Outdoor 2.0 App from the App Store or Google Play.
 - b. Download the App from any app store.
2. Connect the MICRO V2 to Wi-Fi:
 - a. In the main menu, turn on Wi-Fi. See **Advanced Menu > Wi-Fi** on page 36 for detailed instructions.
 - b. Open the App and press the **ViewFinder**  icon on the home screen.
 - c. Click the **Connect the Device** button.
 - d. On the mobile device, go to **Settings > Wi-Fi**.
 - e. Select the MICRO V2 from the list of Wi-Fi networks. It will appear in the list as "MICRO_XXXXV2_YYYY", where XXXX is the model and YYYY is four alphanumeric characters (letters and numbers).
 - f. Enter the Wi-Fi password and tap the **Join** button. The default password is 12345678.
3. Operate the MICRO V2 via the App:
 - a. Take real-time photos and videos, with or without audio. Photos and videos taken via the app are saved to the mobile device.
 - b. View, share, download, and delete photos and videos taken via the App, which are saved to the mobile device.
 - c. Change the Wi-Fi name and password.
 - d. Synchronize the time from the mobile device.
 - e. Perform a non-uniformity correction (NUC).
 - f. Update the firmware.
 - g. Personalize user preferences.

NOTE: When a factory reset is performed, the Wi-Fi SSID and password are reset to the defaults, MICRO_XXXXV2_YYYY and 12345678. See **Advanced Menu > Factory Reset** on page 42.