



# DUAL

DAYTIME FUSION LRF MONOCULAR

---

OPERATING MANUAL



# Important safety information

## Environmental influences

WARNING! Never point the lens of the device directly at intense heat sources such as the sun or laser equipment. The objective lens and eyepiece can function as a burning glass and damage the interior components. The warranty does not cover damage caused by improper operation.

## Risk of swallowing

**Caution:** Do not place this device in the hands of small children. Incorrect handling can cause small parts to come loose which may be swallowed.

## Safety instructions for use

- Handle the device and Battery Pack with care: rough handling may damage the Battery Pack.
  - Do not expose the device to fire or high temperatures.
  - Only use the battery charger included in the delivery package.
  - The battery capacity decreases when operated in a cold ambient temperature. This is not a fault and occurs for technical reasons.
  - Always store the device in its carrying bag in a dry, well-ventilated space. For prolonged storage, remove the batteries.
  - Do not expose your device to extreme temperatures lower than  $-40^{\circ}\text{C}$  and higher than  $+50^{\circ}\text{C}$ .
  - The product shall only be connected to a USB Type C interface.
- If the device has been damaged, send the device to our after-sales service for repair.
-

## Safety instructions for the power supply unit

- Check the power supply unit, cable and adapter for visible damage before use.
- Do not use any defective parts. Defective components must be replaced.
- Do not use the power supply unit in wet or humid environments.
- Only use the original cable provided with the battery charger.
- Do not make any technical modifications.

For further information and safety instructions, please refer to the Operation Instructions provided. This is also available on our website in the download center: [www.infirayoutdoor.com](http://www.infirayoutdoor.com).

## Disposal of batteries

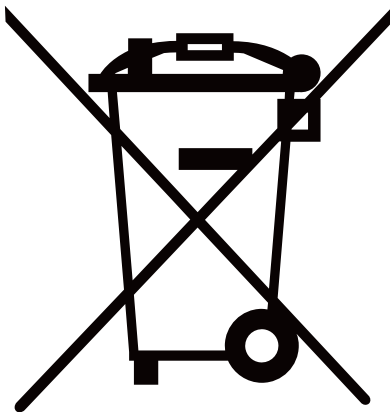

In the European Union, this symbol indicates that the battery used in this product may not be disposed of in domestic waste and must be collected for disposal separately. When returning used batteries, please use a collection system that may exist in your country. The materials and substances in the batteries may have a detrimental impact on health and the environment.

By depositing empty batteries at a recycling facility, you are contributing to the protection, maintenance and improvement of the quality of our environment.

Please only return discharged batteries.

The battery used does not contain mercury, cadmium or lead in quantities exceeding the limits defined in Directive 2006/66/EC.

---

## User information on the disposal of electrical and electronic devices (private households)

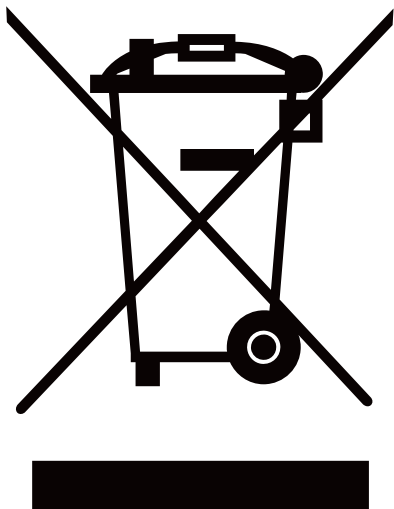

The WEEE symbol on products and/or accompanying documents indicate that used electrical and electronic products must not be mixed with ordinary household waste. For proper treatment, recovery and recycling, take these products to the appropriate collection points where they will be accepted without charge. In some countries, it may also be possible to return these products

to your local retailer when you purchase a corresponding new product. The proper disposal of this product serves to protect the environment and prevents possible harmful effects on human beings and their surroundings, which may arise as a result of incorrect handling of waste.

For further information and safety instructions, please refer to the Operation Instructions provided. This is also available on our website in the download center: [www.infirayoutdoor.com](http://www.infirayoutdoor.com).

More detailed information on your nearest collection point is available from your local authority. In accordance with state legislation, penalties may be imposed for the improper disposal of this type of waste.

### For business customers within the European Union

Please contact your dealer or supplier regarding the disposal of electrical and electronic devices. He will provide you with further information.

### Information on disposal in other countries outside of the European Union

This symbol is only applicable in the European Union. Please contact your local authority or dealer if you wish to dispose of this product and ask for a disposal option.

---

## Intended use

You purchase a corresponding new product. The proper disposal of this product serves to protect the environment and prevents possible harmful effects on human beings and their surroundings, which may arise as a result of incorrect handling of waste.

The device is intended for displaying heat signatures during nature observation, remote hunting observations and for civil use. This device is not a toy for children.

Use the device only as described in this instruction manual. The manufacturer and the dealer accept no liability for damages which arise due to non-intended or incorrect use.

## Function test

- Before use, please ensure that your device has no visible damage.
- Test to see if the device displays a clear, undisturbed image.
- Check that the settings for the device are correct.

## Installing/removing the battery

The Daytime fusion LRF monocular supports USB C power supply.



IRay Technology Co., Ltd. thus declares that the Daytime fusion LRF monocular device complies with the directives 2014/53/EU and 2011/65/EU. The full text of the EU declaration of conformity as well as additional information are available at: [www.infrayoutdoor.com](http://www.infrayoutdoor.com). This device may be operated in all member states of the EU.

Operation Frequency Range:  
2412MHz to 2472MHz  
RF Output Power < 20dBm

## Labeling requirements

This device complies with part 15 of the FCC Rules. Operation is subject to the following two conditions: (1) This device may not cause harmful interference, and (2) this device must accept any interference received, including interference that may cause undesired operation.

## Information to the user

Any Changes or modifications not expressly approved by the party responsible for compliance could void the user's authority to operate the equipment.

**Note:** The manufacturer is not responsible for any radio or TV interference caused by unauthorized modifications to this equipment. Such modifications could void the user's authority to operate the equipment.

For a Class A digital device or peripheral, the instructions furnished the user shall include the following or similar statement, placed in a prominent location in the text of the manual:

**Note:**

This equipment has been tested and found to comply with the limits for a Class A digital device, pursuant to part 15 of the FCC Rules. These limits are designed to provide reasonable protection against harmful interference when the equipment is operated in a commercial environment. This equipment generates, uses, and can radiate radio frequency energy and, if not installed and used in accordance with the instruction manual, may cause harmful interference to radio communications. Operation of this equipment in a residential area is likely to cause harmful interference in which case the user will be required to correct the interference at his own expense.

This equipment complies with FCC RF radiation exposure limits set forth for an uncontrolled environment.

---

## Body-worn Operation

This device was tested for typical body-support operations. To comply with RF exposure requirements, a minimum separation distance of 0mm must be maintained between the user's body and the handset, including the antenna. Third-party belt-clips, holsters, and similar accessories used by this device should not contain any metallic components. Body accessories that do not meet these requirements may not comply with RF exposure requirements and should be avoided. Use only the supplied or an approved antenna.

---



# Specifications

	Model	DP19/6×24WRG
Detector Specifications	Type	Vox
	Resolution, pixels	256×192
	Pixel size, μm	12
	NETD, mK	≤ 40
	Frame rate, Hz	50
Optical Specifications (IR Channel)	Objective Lens, mm	19
	Field of View (H×V)	≥9°×6.7°
	Linear Field of View (H×V) , mat 100m	15×12
	Magnification, ×	2~8
	Detection Range, m (Target size: 1.7m×0.5m, P(n)=99%)	980
Optical Specifications (Day Channel)	Magnification, ×	6
	Objective Lens Diameter, mm	24
	Field of View, °	7
	Eye Relief, mm	25
	Exit pupil Diameter, mm	4
	Diopter,D	-4 ~ +4
Display Specifications	Type	AMOLED
	Resolution, pixels	1920×1080
	Color	Green
Battery Power Supply	Battery	3600mAh
	Max. operating Time(22°C)*, h	8
	External Power Supply	5V (USB C)
Physical Specifications	Wi-Fi/APP	Support (InfiRay Outdoor)
	Photo/Video Recorder	Support
	Memory Capacity, GB	16
	IP rating	IP67
	Operating Tempeture, °C	-20 ~ +50
	Weight, g	460
	Dimension, mm	135×46×93
	Body Material	Magnesium Alloy

Functions	Laser rangefinder	Yes
	Measuring Range, m	1500
	Measuring Angle, °	±60
	Measurement Accuracy	±1m, ±1°
	Wavelength, nm	905

※ The actual service time depends on the use frequency of functions like Wi-Fi, video recording, etc.

Improvements may be made to the design and software of this product to enhance its features without prior notice;

You can download this User Manual at our official website: [www.infirayoutdoor.com](http://www.infirayoutdoor.com).

# I. Package Contents

- Daytime fusion LRF monocular
- Power adapter
- USB C charging data cable
- Dual device portable strap
- Dual device bag
- Lens cleaning cloth
- Quick start guide
- Quality card
- Thermal+ stickers

## II. Description

Daytime fusion LRF monocular (hereinafter referred to as "Dual") is a multi-spectral and multi-function monocular integrating thermal monocular, daytime monocular laser rangefinder, electronic compass, and other functions. The product mainly features that the direct-view day channel combines with thermal channel for target enhancement. By expanding thermal imaging applications based on traditional daylight monocular, this product is advantageous in both the degraded use and the enhanced search capability in the daytime, as well as the ability to find targets quickly at night. Hence, it is a distinctive monocular in the market.

## III. Product Features

- Functions of daytime monocular, laser rangefinder, and thermal monocular are integrated.
  - It supports laser ranging, with a maximum measuring distance of 820m for deer, and the function is available both day and night.
  - It adopts excellent 6× magnification and 7° FOV.
  - Ergonomic design, comfortable to hold and easy to operate.
  - Support Wi-Fi, photographing/recording, etc.
  - The product supports ranging mode, thermal mode, and target highlighting mode.
  - The multi-spectral and common-optical-path optical fusion technology is adopted to realize the fusion of daylight, laser, and infrared.
-





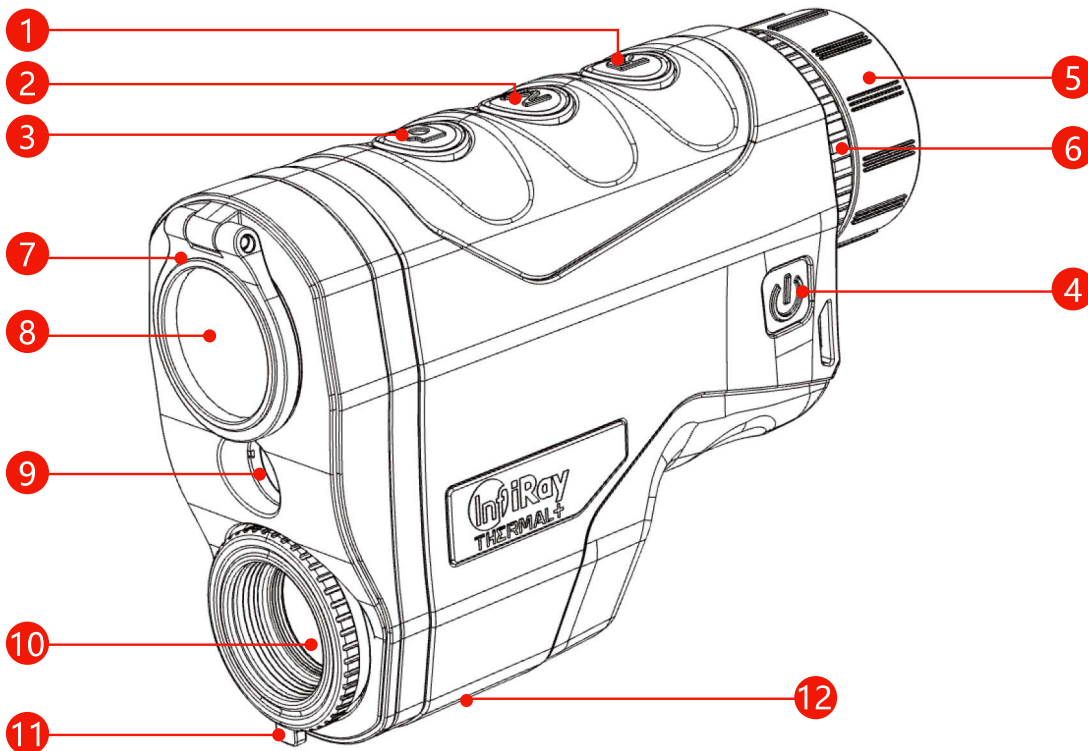

- Magnesium alloy shell, metallic texture, solid and durable.
- Up to 9 laser reticle styles and 2 laser reticle colors.
- 3600mAh rechargeable battery, 8h ultra-long battery life.

## IV. Device Composition

- 1 Rangefinding button
- 2 Menu button
- 3 Capture button
- 4 Power button
- 5 Eyepiece
- 6 Eyepiece adjusting ring
- 7 Direct-view day channel lens cap
- 8 Direct-view day channel
- 9 Laser port
- 10 Thermal channel
- 11 Thermal channel adjustment ring
- 12 USB C interface



# V. Button Operation



Button	Current Mode	Press	Press and Hold
	Powered off	--	Power on the device
	Powered on	Enable sleep mode	Shutdown
	Menu	Return to the upper menu without saving changes	--
Capture button 	Infrared observation interface	Photo	Record
	Recording	Photo	End the recording and save the video
	Menu	Move up/right	Quickly move the cursor
	Parameter interface	Move up/right	Quickly adjust parameters
Menu button 	Home screen	Switch between observation modes	Enter the menu
	Main menu interface	Open the menu option	--
	Submenu	Open the menu option	--
	Menu option	Confirm the parameter	Return to the home screen/submenu
Laser Ranging button 	Any observation interface	Single ranging	Scanning
	Menu	Move down/left	Quickly move the cursor
	Parameter interface	Move down/left	Quickly adjust parameters
	Infrared observation interface	Switch between electronic zoom settings	--
	Infrared observation interface	Shutter calibration	Background calibration

- Press and hold the **Menu + Power** buttons for 10s to open the interface for adjusting the laser reticle position.
- Press and hold the **Menu + Capture + Laser Ranging** buttons for 10s to open the interface for adjusting the image moving position.

## VI. Battery Charging

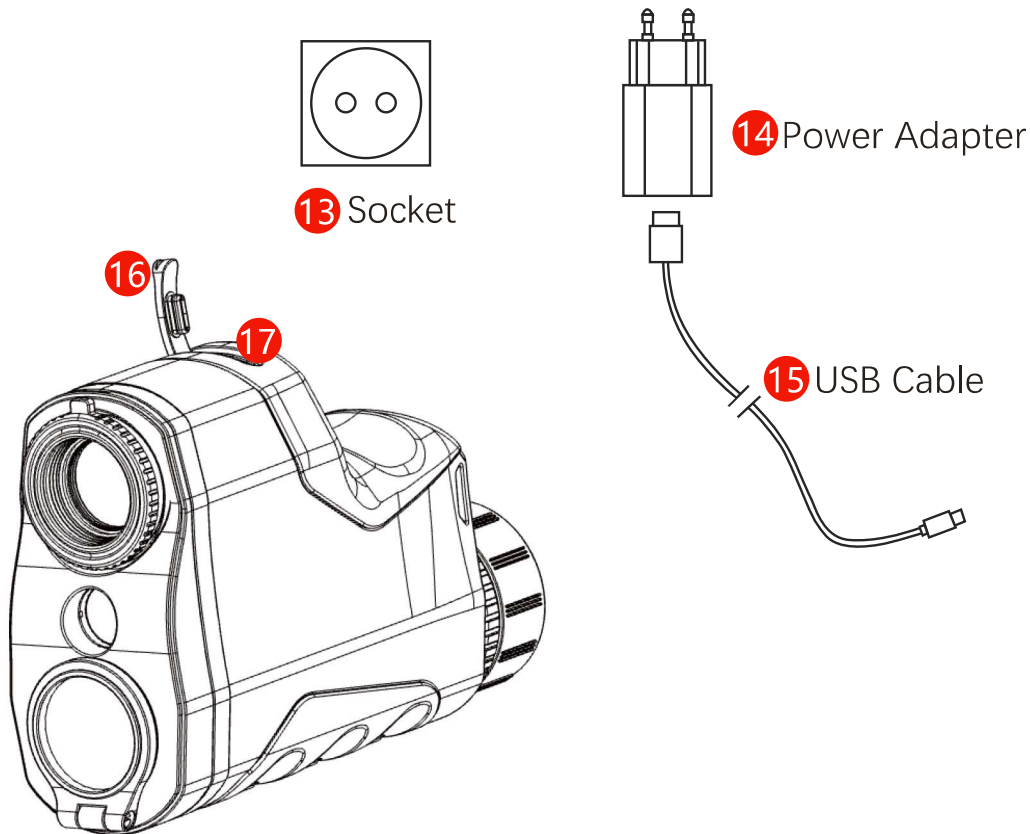
Dual is powered by a battery with a built-in cell, a rechargeable lithium-ion battery pack that provides battery power for up to 8 hours of normal operation. The battery should be fully charged before the first use.



- Open the USB C waterproof cover (16);
  - Insert the USB C end of the data cable (15) into the USB C socket (17) on Dual;
  - Connect the other end of the data cable to the power adapter (14), and insert the adapter into a 100–240V power socket (13) for charging;
  - When charging, a lightning charging icon  appears on the battery icon, flashing alternately with the current battery level, and the LED indicator on the device is in red. When the LED indicator turns green, it indicates that the charging is completed.
  - During use, when displaying  inside the icon, it indicates that the power is higher than 20%, with sufficient power. If the battery icon turns empty and flashes, it indicates a low battery level. Please charge the battery in time to avoid the reduced service life of the device due to battery over-discharging.
-

## Safety Precautions

- When charging, please use the 5V2A power adapter compatible with the device. Using any other type of power adapter may cause irreversible damage to the battery or the adapter itself;
- If the device is not in use for a long time, the battery should be partially charged, not fully charged or discharged.
- Do not charge the device immediately after it is moved to a warm environment from a cold environment. Wait for 30 to 40 minutes for preheating.
- Do not use the charger if it is modified or damaged;
- The device should be charged at a temperature of 0°C to +40°C. Otherwise, the battery life will be significantly reduced.
- When charging, please do not leave the battery unattended;
- Do not connect the battery to the power supply for more than 24 hours after it is already fully charged;
- It is better not to connect the device to third-party devices that consume more energy than the allowed value.
- The device is equipped with a short circuit protection system, but conditions that may lead to a short circuit should be avoided.
- The recommended operating temperature for the device is from -20°C to +50°C. Do not use the device beyond this temperature range, or else, it may shorten the battery endurance.
- When the device is used under sub-zero temperature, the battery capacity drops. This is normal and does not indicate a defect.

## VII. External Power Supply

Dual supports external power supplies, such as the portable power source for a mobile phone (5V).

- Connect an external power supply to the USB C port (12) of Dual;
  - Then, the device automatically switches to the external power supply and charges the internal battery pack at the same time;
  - When the external power is turned off, the device will switch to the battery pack for the power supply.
-

# VIII. Usage

## Notes for Use

**WARNING:** The lens of the thermal imaging scope must not be pointed at any sources of intense radiation energy, such as laser-emitting devices or the sun. This may damage the electronic components in the device. Damage caused by failure to comply with the operating manual is not covered under warranty.

## Power-on and Settings

- Open the lens cap; if the outdoor sunlight is strong, make sure the lens does not face the sunlight to avoid burns;
  - Press and hold the Power button for 3s to power on the device;
  - Rotate the eyepiece diopter ring until the icon on the screen is clear;
  - Rotate the focus ring of the infrared objective lens to adjust the focal length until the infrared image is clear
  - Set the image palette: On the infrared mode, press and hold the **M** button and press **Camera** and **Rangefinding** buttons to set the image palette, of which the options include black hot – green hot in sequence, and the icon on the top status bar is updated in real-time;
  - Set the screen brightness: On the menu, select the "Screen Luminance" option, and screen brightness can switch between 6 levels from 0 to 5;
  - Set image parameters: After operating according to the rules, enter the main menu to set image parameters (image brightness, image contrast, and image sharpness);
  - Press the **Power** button and the device will enter standby mode. Press the **Power** button again to wake it up.
  - After use, press and hold the **Power** button for 3s, and an interface of a shutdown confirmation is displayed. After confirming by pressing the button, the display turns black and the device is powered off when the data is saved. **When the device is powering off and saving data, do not disconnect it from the power source. Otherwise, data cannot be saved.**
-





## IX. Digital Zoom



Dual can perform 1×, 2×, and 4× digital zoom on images.

- On the home screen, press both **M** and **Capture** buttons to zoom in/out on the image;
- The magnification is displayed at the status bar of the display area in real time.

## X. Wake

In the power-on status, press the **Power** button and the device enters sleep mode, with the screen going black; in the sleep status, press any button to light up and awaken the screen. If the screen in sleep mode is not lit up for more than 1h, the product will power off automatically.

## XI. Observation Mode

On the home screen, press the Menu button to switch the observation mode quickly and circularly. There are 3 observation modes available for users to choose from, including thermal , fusion highlighting , and direct-view . The default mode after startup is the thermal mode.



## XII. Image Calibration

There are 2 calibration methods for infrared images: shutter calibration and background calibration.

Manual shutter calibration: Press both **Menu + Rangefinding** buttons to complete image calibration;

Background calibration: Close the infrared lens cap, and press and hold **both Menu + Rangefinding** buttons to complete the background calibration. Before calibration, there will be a text prompt

**Cover lens when calibration.** for closing the lens cap, and background calibration will be carried out after 2s. After calibration, remove the lens cap.

## XIII. Photo Taking/Video

Dual is equipped with a built-in 16GB memory space, which allows photo taking and video recording of an observed target. The image and video files will be named after time, so it is recommended to set the system date and time settings in the advanced menu before using the photographing and video recording functions (refer to "**Main Menu-Settings-Date/Time Setting**").

### Photo

- On the home screen, press the Capture button to take a photo, and a photo icon appears on the right side of the status bar  ;
- The images taken are saved in the internal memory space.

### Record

- On the home screen, press and hold the Capture button to start the video recording;
  - A recording icon and a prompt box showing the recording time will appear in the upper right corner of the display  , with the time format as 00:00 (minute: second);
  - During recording, you can also take a photo by pressing the Capture button;
  - Press and hold the **Capture** button **again** to stop the recording and save the video;
  - The videos and images captured are saved in the internal memory space.
-

## Note:

- You can open and operate the menu during video recording;
- All images taken and videos recorded will be saved in the built-in memory card in the formats of IMG\_YYYYMMDDhhmmss\_XX.jpg (photos) and VID\_YYYYMMDDhhmmss\_XX.mp4 (videos), of which YYYYMMDDhhmm refers to year/month/day/hour/minute/second, and XX the serial number of the two-bit multimedia file;
- The serial number of the multimedia file can not be reset;

## Notes:

- The maximum duration of a video recording file is 5 minutes. When the duration is more than 5 minutes, the video will be automatically recorded onto a new file;
- The number of files is fixed and limited by the memory space of the device. Each device can store 1,650 photos and 850 videos. If it is beyond this amount, the oldest photos or videos will be automatically replaced. Please regularly transfer the material and photos to other media to free up the space on the memory card.
- The interface icon information is not displayed on the captured video or image.

## Memory Access

When the device is powered on and connected to a computer, it will be recognized by the computer as a flash memory card. Then, you can access the memory of the device and copy images and videos.

- Connect the device to a computer through the USB cable;
  - Power on the device;
  - Double-click "My Computer" on the desktop of the computer, find the device named "U disk" and double-click to open folders named "VIDEO-CIF" and "PHOTO-CIF" to access photos and videos;
  - Open the memory file, and there are different folders named after time in the format of xx (day)xx (month) xxxx (year) in it;
  - Select required files or folders to copy or delete.
-

## Note:

- After the device is connected to the computer, it prompts that only part of the memory is available. This is because the storage algorithm mechanism adopted by the device is different from that of the computer and does not represent the actual memory occupation. Please check the actual memory in Dual's device file management.
- After connecting the computer, do not use the computer's formatting tool to format the device, because this operation will clear the program inside the device!

## XIV. Laser Rangefinding

In the observation mode, there are two modes of laser rangefinding: single ranging and continuous ranging. The target distance is displayed as 0000 m by default.

Single ranging mode: Align the center of the laser rangefinding reticle with the target, press the **Rangefinding** button on the laser rangefinding module, and the target range information is displayed on the screen;

Continuous ranging mode: Align the center of the laser rangefinding reticle with the target, press and hold (3s) the **Laser Rangefinding** button to enable the continuous ranging mode, and the target distance information is displayed on the screen and updated continuously, with a 1-second update time. Press the **Rangefinding** button to exit the continuous ranging mode.



## XV. Status Bar

The status bar is located at the top, right, and bottom of the image interface and displays information related to the current operating status of the device. From the top down and left to right, there are:

**Top:** Image mode, polarity, Wi-Fi status, analog video status, azimuth angle, video recording, photo taking, digital zoom, battery level, and current time.

**Right:** Angles of pitch and inclination.

**Bottom:** The value of the target distance and angle measurement after laser rangefinding is enabled.



## XVI. Main Menu

The shortcut menu enables quick adjustments to the basic settings of some common functions, including screen brightness, Wi-Fi settings, polarity switching, image brightness, image contrast, image sharpness, reticle type, reticle color, and analog video. Press the **M** button to confirm saving, or press the **Power** button to exit and return to the previous level without saving.

- On the home screen, press and hold the **M** button to enter the main menu;
- Switch the following function options by pressing the **Capture** button and **Rangefinding** button, and the selected item will be highlighted:



- **Screen Luminance:** After selecting this option, press the M button to adjust the brightness from 0 to 5;
  - **Wi-Fi:** After selecting this option, press the M button to turn on/off Wi-Fi;
  - **Polarity:** After selecting this option, press the M button to switch between green hot and black hot;
  - **Reticle:** After selecting this option, press the M button to set the reticle type and color;
  - **Image Settings:** After selecting this option, press the M button to set image brightness, image contrast, and image sharpness;
  - **Video Output:** After selecting this option, press the M button to turn on/off the video output;
  - **File Management:** After selecting this option, press the M button to manage photos and video files;
  - **Advanced Menu:** After selecting this option, press the M button to perform advanced settings.
- Press the Power button to return to the home screen.

## 1. Screen Luminance

Select the "Screen Luminance" option in the main menu, press the **Menu** button to enter the "☀️" adjustment interface, and press the left and right buttons to adjust the screen brightness. There are 6 adjustable levels of screen brightness from 0 to 5 from dark to bright. Press the **Menu** button to confirm and return to the previous level. The default level is 3. The screen brightness for the next startup is the value set last time.

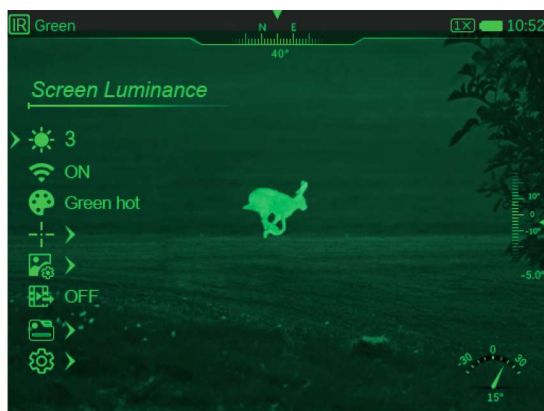

## 2. Wi-Fi Settings

On the main menu, select the "Wi-Fi" option, press the **Menu** button to display the "ON" and "OFF" buttons, and press the left and right buttons to select. When the Wi-Fi is on, the status bar displays the "  " icon. When the Wi-Fi is off, the status bar does not display the Wi-Fi icon. By default, the Wi-Fi is off. After each startup, the status of the Wi-Fi is the one set before the last device shutdown.



## 3. Polarity

Select the "Polarity" option in the main menu, press the **Menu** button to enter the "  " adjustment interface, and press the left and right buttons to adjust the polarity. There are 3 adjustable polarities: green hot, black hot. Press the **Menu** button to confirm. The default setting is white hot.



## 4. Reticle Settings

### a) Reticle Style

Select the "Reticle Style" option in the main menu, and press the **Menu** button to enter the "  " selection screen. Press the left and right buttons to adjust the reticle style. There are 9 reticle styles from 1 to 9 available, and the default style is 1.

By default, the reticle style is 1. Next startup, the reticle style is the one set in the last use.

---

## b) Reticle Color

Select "Reticle Color" in the main menu, and press the **Menu** button to enter the interface for selecting the reticle color. Press the left and right buttons to select the reticle color, with 2 black and green colors available. Press the **Menu** button to confirm selection and return to the upper menu, press the **Power** button to return to the shortcut menu, and press and hold the **Menu** button to return to the home screen. The default reticle color is green. Next startup, the reticle color is the one set in the last use.



## 5. Image Settings

### a) Brightness

Select the "Brightness" option in the main menu, press the **Menu** button to enter the "☀️" adjustment interface, and press the left and right buttons to adjust the image brightness. There are 6 adjustable levels of brightness from 0 to 5 from dark to bright. Press the **Menu** button to confirm. The default level is 3. The brightness for the next startup is the value set last time.







## b) Contrast

Select the "Contrast" option in the main menu, and press the **Menu** button to enter the "  " adjustment interface, as shown in the figure. Press the left and right buttons to adjust the image contrast. There are 6 adjustable levels of image contrast from 0 to 5 from dark to bright. The default level is 3. The contrast of the next startup is the value set for the last use.

## c) Image Enhancement

Select the "Image Enhancement" option in the main menu, and press the **Menu** button to enter the "  " adjustment interface, as shown in the figure. Press the left and right buttons to adjust the enhancement intensity. There are 6 adjustable levels of image enhancement from 0 to 5 from weak to strong. The default level is 0 (the level without enhancement). The image enhancement value for the next startup is the value set for the last use.

## 6. Video Output

On the main menu, select the "  " option, and press the **Menu** button to display the "ON/OFF" button. Press the left and right buttons to select "ON/OFF" circularly. Press the **Menu** button to confirm the selection and return to the previous level, press the **Power** button to return to the previous level, and press and hold the **Menu** button to return to the home screen.

When the video output is on, the "  " icon appears in the status bar, and when off, the icon disappears. By default, it is off.



## 7. Document Management

In the main menu, select the "  " option, and press the **Menu** button to enter the file management interface, which consists of 4 parts, namely, file list, file information, thumbnail, and storage information. The file list includes lists of photos and videos. The photo file list is displayed by default. Press the up or down buttons to switch between the photo list and the video list. Press the **Power** button to return to the previous level, and press and hold the **Menu** button to return to the home screen.



Files are arranged in descending order according to the number, that is, the latest shot is in the first place on the list, and the list displays up to 12 files on each page.

### a) Play and delete

On the file management screen, press the Menu button to enter the "Play/Delete" option. Press the up or down button to select the play or delete options. Press the Menu button again to select "Play" or "Delete". Press the Power button to return to the file list. Press and hold the Menu button to return to the home screen.

### b) Page up/down

In the photo and video lists, press the up or down buttons to turn pages.

### c) Back

In the photo and video lists, press the Power button to return to the previous level, and press and hold the Menu button to return to the home screen.

### d) Photo playback

On the photo playback screen, press the up and down buttons to switch the current photo file. After reaching the first picture, the backward icon disappears, and it cannot continue. Similarly, after reaching the last picture, the forward icon disappears, and it cannot continue. On the

photo playback screen, the file name will automatically disappear after a display of over 5s and become a full-screen display. On the current screen for playing photo files, press the Power button to return to the photo file list, and press and hold the Menu button to return to the home screen.

#### e) Video playback

On the video playback screen, press the up or down buttons to switch the current video file. After reaching the first video, the backward icon disappears, and it cannot continue. Similarly, after reaching the last video, the forward icon disappears, and it cannot continue. The current video playback screen displays the total and the elapsed play time. Press the Menu button to pause, press the left and right buttons to fast forward or fast backward, press the Power button to return to the video file list, and press and hold the Menu button to return to the home screen.

## XVII. Advanced Menu

- On the home screen, press and hold the **M** button to enter the main menu;
  - Switch between the **Capture** and **Rangefinding** buttons to select the advanced menu options, including "Date/Unit/Compass Calibration/Compass Information Display/Status Auto Hiding/Blind Pixel Defect Correction/Language Settings/Format/Update/Factory Reset/Info"
  - Press the **M** button to modify the parameters of the current option or go to the next level of the menu;
  - Under all menu interfaces, press and hold the **M** button to save changes and return to the home screen, and press the **M** button to save changes and stay on the menu;
  - On any menu, the device will automatically return to the home screen without saving the changes when there is no operation within 30s.
-

## Advanced Menu Operations

### Date and Time Settings



- On the submenu, select the "Date" option, and press the **Menu** button to open the time setting page;
- The 24-hour system is adopted, in a format of "20XX-XX-XX, XX:XX";
- The default setting is 2022-01-01, 00:00;



### Units of Measure



- On the submenu, select the "Unit" option, and press the **Menu** button to display the 2 options of "meter/yard";
- Press the up or down buttons to select "meter/yard", and press the **Menu** button to confirm the selection and return to the previous level;
- The default unit is meter;



## Compass Calibration



- On the main menu, select the "Compass Calibration" option, and press the **Menu** button to display the calibration prompt interface;
- Rotate the device along the three axes indicated by the icon, with each axis rotating at least 360°;
- The calibration ends by default after 15s, and it automatically saves changes and returns to the main menu;



## Compass



- On the submenu, select the "Compass Display" option;
- Press the **Menu** button and 2 options of "ON/OFF" appear;
- Press the left and right buttons to select "ON/OFF";
- By default, the Status Auto Hiding function is off.

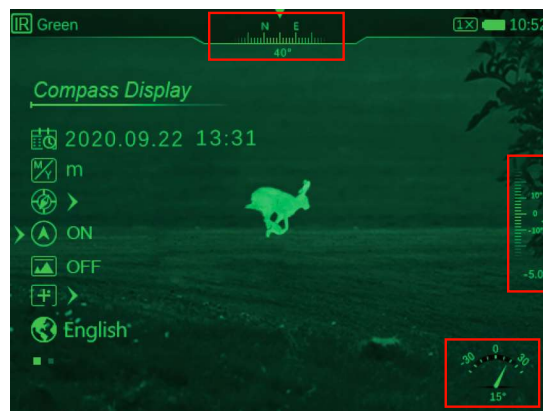

## Status Auto Hiding



- On the submenu, select the "Status Auto Hiding" option;
- Press the Menu button and 2 options of "ON/OFF" appear. Press the left and right buttons to select "ON/OFF";
- The status bar will automatically hide after 10s of no operation on the observation page
- By default, the Status Auto Hiding function is off

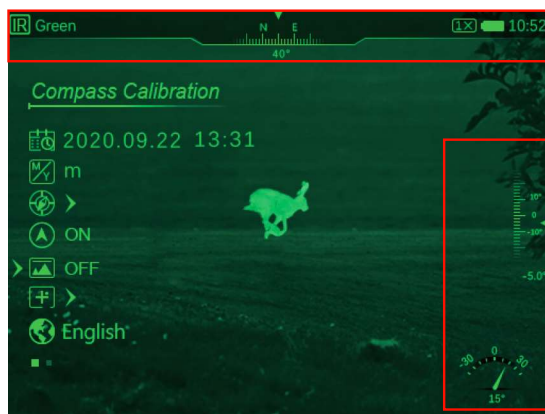

**Note:** Where the main menu is opened when the Status Auto Hiding is on, if there is no operation within 30s, the device will return to the home screen. On the observation page, the status bar will automatically hide after 10s of no operation.

## Pixel Defect Correction



- On the submenu, select the "Pixel Defect Correction" option, and press the **Menu** button to enter the pixel defect correction interface;
- The number of selected defective pixels is displayed in the lower left corner of the interface;
- On the pixel defect correction, the pixel defect correction cursor appears, and there are four position options of "X, Y,  $\sqrt$ , and  $\times$ ". Press the **Menu** button to enter the corresponding position, and press the **Power** button to return to the upper menu;
- For selecting X, press the **Menu** button to enter the X direction adjustment, press the left or right buttons to move the cursor by 1 pixel each time, and press and hold the left or right buttons to move by 10 pixels each time.

- For selecting Y, press the **Menu** button to enter the Y direction adjustment, press the up or down buttons to move the cursor by 1 pixel each time, and press and hold the up or down buttons to move by 10 pixels each time
- Select "√" for pixel defect correction, and automatically return to the main menu after correction. Select "×" to exit pixel defect correction and return to the main menu

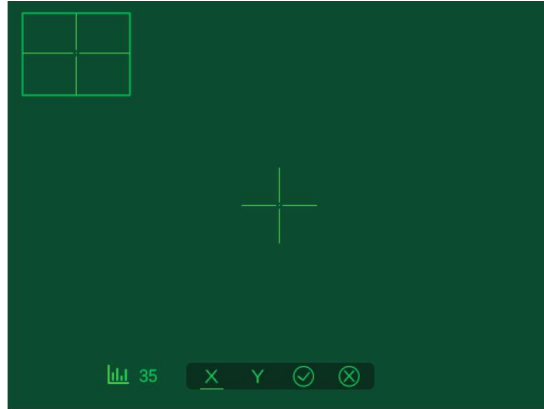

## Language Settings



- On the submenu, select the "Language Settings" option;
- Press the **Menu** button, and it displays 4 options: "English/ Chinese/Russian/German/French";
- Press the up or down buttons for selection, press the **Menu** button to confirm the selection and return to the upper menu, press the **Power** button to return to the upper menu, and press and hold the **Menu** button to return to the home screen;
- The default language is English;



## Formatting of storage



- On the secondary menu, select the "Format" option, and press the **Menu** button to enter the format tab;
- A pop-up prompts "Yes/No" to format the memory card. Press the left and right buttons to select "Yes/No", and the default is "No";
- Press the **Menu** button to confirm the selection and return to the upper menu, and press the **Power** button to return to the main menu;



## Update



- On the submenu, select the "Update" option, and press the **Menu** button to enter the setting option for the software update;
- The pop-up prompts "Yes/No" for detection and update, and the power cannot be cut off;
- For a "No" selection, press the **Menu** button to confirm the selection and return to the upper menu, and for "Yes", the device will automatically detect the updateable software and automatically upgrade it;





## Factory Reset



- Select the "Factory Reset" option, and press the **Menu** button to open it;
- For a "No" selection, press the **Menu** button to confirm the selection and return to the upper menu, and for "Yes", the device will restart automatically;
- The following function parameters will be restored to their default settings after finishing the reset;



## Information



- Select the "Info" option and press the **Menu** button to query relevant device information;



## XVIII. Wi-Fi

Dual has a built-in Wi-Fi module. The device can connect wirelessly to a mobile apparatus (laptop or mobile phone) via Wi-Fi.

- In the advanced menu, enable Wi-Fi. For detailed operations, refer to "**Advanced Menu-Wi-Fi**".
- After the Wi-Fi of the scope is enabled, search for the Wi-Fi signal with the name "Dual\_DP19 \_XXXX" on the mobile device, of which, XXXX is a 4-bit serial number composed of digits and letters.
- Select the Wi-Fi, enter the password, and connect. The initial password is 123456789;
- After Wi-Fi connection is established, you can control the device via the app on the mobile device.

### Setting Wi-Fi Name and Password

Dual allows you to change the name and password of the device Wi-Fi in the app.

- After the scope is connected to the mobile device, locate the **Settings** icon"  "on the **InfiRay Outdoor** image screen and tap it to open the **Settings** interface;

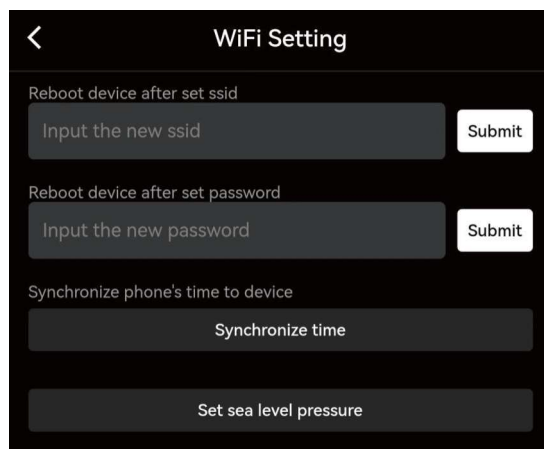

- In the text box, enter and submit the new Wi-Fi name (ssid) and password;
- After submitting the changes, reset the device to activate them.

**Note:** If the device is reset, the name and password of the Wi-Fi will also be restored to the default settings.

## XIX. Product Update and Description of App

You can download the user manual of InfiRay Outdoor at our official website ([www.infirayoutdoor.com](http://www.infirayoutdoor.com)). You can also test and update the software of the product via the InfiRay Outdoor app or download it on our official website.

### About InfiRay Outdoor

- You can download and install the InfiRay Outdoor app on the official website ([www.infirayoutdoor.com](http://www.infirayoutdoor.com)) or the app store. Alternatively, you can scan the QR code below to download it for free.



- Open the InfiRay Outdoor app after installation;
  - If your device has been connected to a mobile device, please switch on the mobile data of the mobile device. After the device accesses the Internet, an update prompt appears automatically on the app. Tap Now to download the latest version immediately or Later to update later;
  - InfiRay Outdoor automatically registers the last connected device. Therefore, once you have connected with InfiRay Outdoor before, it will automatically detect the update even when the scope is not connected to a phone or laptop. If an update is available and the mobile device accesses the Internet, you can download the update first. After the download is completed, connect the scope to the mobile device and the update process automatically starts;
  - After the update is installed, the device will restart automatically.
-

## XX. Technical Inspection

Perform a technical inspection to check the following items each time before you use the device.

- Exterior of the device (no crack on the enclosure).
- Lens and eyepiece (no crack, oil, stain, or other sediments)
- Status of the rechargeable battery (fully charged in advance) and electrical contact (no salinization or oxidation).

## XXI. Maintenance

The maintenance should be carried out at least twice a year and includes the following steps:

- Wipe the surface of metal and plastic parts to clear off dust and dirt by using a cotton cloth. Silicone grease may be used for the cleaning process.
- Clean the electric contact and battery slots on the device using a non-greasy organic solvent.
- Check the glass surface of the eyepiece and lens. If necessary, clear off the dust and sand on the lens (it is perfect to use a non-contact method). Use a specialized wiping tool and solvent to clean the optical surfaces.

## XXII. Troubleshooting

The following table lists all problems that are likely to occur during device operation. Check and address problems by referring to this table. If faults not included in this table occur or you cannot fix the fault, return the device to its vendor or supplier for troubleshooting.

---

<b>Fault</b>	<b>Possible Causes</b>	<b>Solution</b>
The scope cannot be started.	The battery is out of charge.	Charge
The device cannot be powered by using an external power supply.	The USB cable is damaged.	Replace the USB cable.
	The external power supply is insufficient.	If necessary, check the external power supply.
Images are unclear, vertical lines are present, or the background is not even.	Calibration is required.	Calibrate the images as instructed in Chapter IX of the User Manual.
The image is too dark.	The screen is not bright enough.	Adjust the display brightness
The icons are clear but the image is blurry.	The lens is not focused, or the inner or outer optical surface of the lens is dusted or iced.	Rotate the lens focus ring to adjust the focus. Wipe the outer optical surface by using a soft cotton cloth or leave the scope to dry in a warm and dry environment for more than 4 hours.
The position of the reticle moves after shooting.	The scope or the clamp is not mounted firmly.	Check whether the scope is mounted firmly. Ensure that the bullet type and caliber you use are consistent with that used for zeroing. If you perform zeroing in summer but use the scope in winter (or vice versa), the zeroing point may move slightly.
The scope cannot focus.	Configuration error.	Set the scope according to the contents specified in Power-on and Settings. Check the outer surface of the objective lens and eyepiece, and if necessary, wipe off any dust and frost on it. In cold weather, a special antifogging coating can be applied (such as those used on eyeglasses or car rearview mirrors).
The device cannot connect to a mobile phone or computer.	The Wi-Fi password is incorrect.	Enter the correct password.
	There are too many Wi-Fi networks in the range of the device, which may cause interference.	To enable stable network access, you are advised to move the device to an area with a limited number of Wi-Fi networks, or an area without Wi-Fi coverage.
Wi-Fi signals are lost or interrupted.	The device is beyond Wi-Fi coverage. There is blocking (such as concrete walls) between the device and the receiver.	Move the device to a place where you can receive Wi-Fi signals.
The observed target disappears.	You are observing the target through the glass.	Observe the target directly without the presence of glass.
The image quality is poor or the detection range shortens.	These problems are likely to occur when you use the device in harsh weather (such as snow, rain, and fog).	

## XXIII. Legal and Regulatory Information

Wireless transmitter module frequency range:

**WLAN: 2.412-2.472GHz (for EU)**

Wireless transmitter module power < 20dBm (only for EU)

IRay Technology Co., Ltd. thus declares that the Dual series thermal imaging monocular complies with the directives 2014/53/EU and 2011/65/EU. The full text of the EU declaration of conformity as well as additional information are available at: [www.infirayoutdoor.com](http://www.infirayoutdoor.com). This device may be operated in all member states of the EU.

### **FCC Statement**

FCC ID:2AY3N-DUAL19

- After the device is turned on, press and hold the **Menu** button to enter the function menu.
  - By pressing **Capture** button or **Laser Rangefinding** button, move the cursor up and down until the "Device Information" option in "Advanced Settings" is selected.
  - Press the **Menu** button to enter the "Device Information" for viewing.
-





**IRay Technology Co., Ltd.**

---

Add.: 11th Guiyang Street, YEDA, Yantai 264006, P.R. China

Tel:0086-400-998-3088

Email: [infirayoutdoor@infiray.com](mailto:infirayoutdoor@infiray.com)

Web: [www.infirayoutdoor.com](http://www.infirayoutdoor.com)