

Instruction Manual

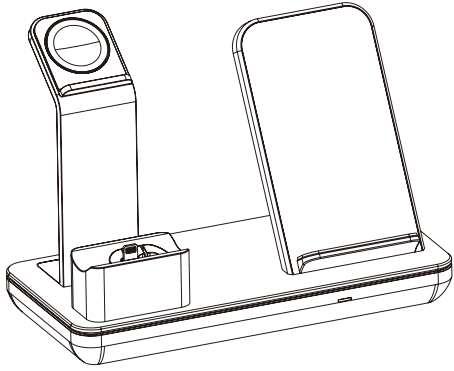

Please read the instructions carefully first, in order to install the product correctly for quick use.

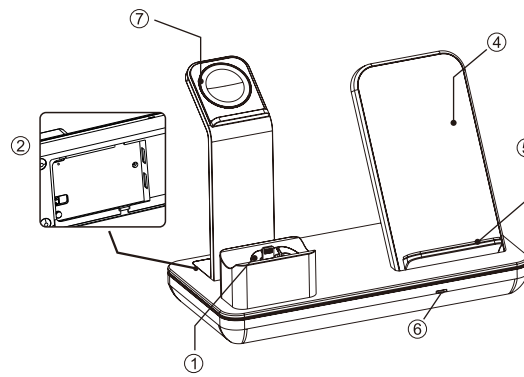

Product Introduction

- ① : Cable fixing silica gel
- ② : cable management
- ③ : type-c interface
- ④ : Mobile Phone Wireless Charging Pad
- ⑤ : Anti-slip Mat
- ⑥ : indicator light
- ⑦ : iWatch charger fixed silica gel

Specifications

Product Name: 3 in 1 wireless charging stand

Product Material: Aluminum alloy, Plastic, PCB, PE, Rubber

Input: 5V=3A / 9V=2A

Frequency: 115-205kHz

Conversion Efficiency: >79% (max)

Charging distance: ≤6mm

Power Interface: Type-C

Product Dimension: 180*88*133mm

FCC ID: 2AY3K-YFWW004

Applicable Mobile Phone Mode: Mobile phone with wireless charging function or external wireless charging receiver

NOTE:

Do not use Apple's 5v/1A stock charger or a computer's usb port to power your wireless charger.

Cases made of metal, attachments such as magnets, cards, grips will interfere with charging

Quick charge 3.0 wall adapter required for fast charge mode

Power indicator status

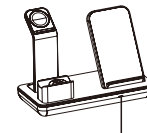

1. Turn on the power and the blue light will be on for 1 s
2. The blue light is always on when the mobile phone is charging normally
3. The red light is flashing, and there are metal foreign matters on the charging board

This device complies with part 15 of the FCC Rules. Operation is subject to the following two conditions: (1) this device may not cause harmful interference, and (2) this device must accept any interference received, including interference that may cause undesired operation.

Any changes or modifications not expressly approved by the party responsible for compliance

could void the user's authority to operate the equipment.

NOTE: This equipment has been tested and found to comply with the limits for a Class B digital device, pursuant to Part 15 of the FCC Rules. These limits are designed to provide reasonable protection against harmful interference in a residential installation. This equipment generates, uses and can radiate radio frequency energy and, if not installed and used in accordance with the instructions, may cause harmful interference to radio communications. However, there is no guarantee that interference will not occur in a particular installation.

If this equipment does cause harmful interference to radio or television reception,

which can be determined by turning the equipment off and on, the user is encouraged to try to correct the interference by one or more of the following measures:

- Reorient or relocate the receiving antenna.
- Increase the separation between the equipment and receiver.
- Connect the equipment into an outlet on a circuit different from that to which the receiver is connected.
- Consult the dealer or an experienced radio/TV technician for help

This device complies with part 15 of the FCC Rules. Operation is subject to the following two conditions: (1) This device may not cause harmful interference, and (2) this device must accept any interference received, including interference that may cause undesired operation.

FCC RF exposure statement:

The equipment complies with FCC radiation exposure limits set forth for an uncontrolled environment. During the operation of device a distance of 15 cm surrounding the device and 20 cm above the top surface of the device must be respected.

正面



Apple Watch

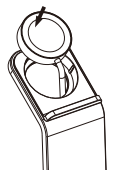

Press the round head of the iWatch charging cable into the round groove

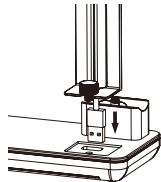

Get the USB head of the iWatch charging cable through the hole under the iWatch charging base

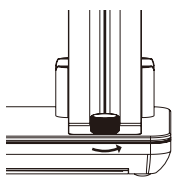

Fix and tighten the watch bracket

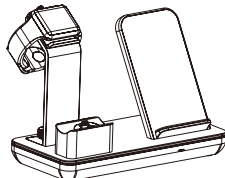

Well Done!



Airpods

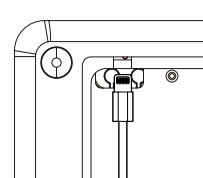

Push out the silica gel with your fingers from the bottom of the bottom shell, and put the lightning through the hole shown in the figure

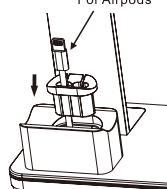

The AirPods cable is placed in a smaller silica gel hole and the lightning is inserted into the bracket

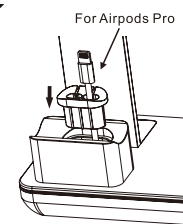

The AirPods Pro cable is placed in a larger silica gel hole and the lightning is inserted into the bracket

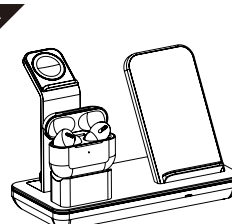

Well Done!



Bottom

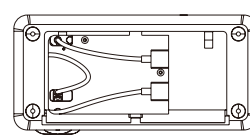

Install the USB line according to the diagram built-in cord organizing space can help you manage your long cable

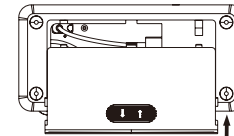

Slide forward the bottom cover and fix it

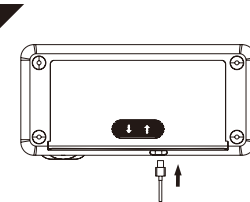

Get a type-c line access interface

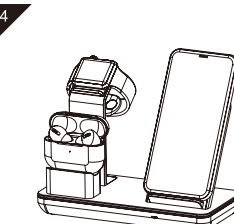

Good Job, Finish!

反面