

Dear Customer,

Thank you for choosing an Elipson audio product.

Please read carefully the following information before using your new loudspeakers.

It contains tips to get the most of it and instructions for safety use.

We strongly recommend that you keep the packaging and this user manual for further use.

FCC STATEMENT

1. This device complies with Part 15 of the FCC Rules. Operation is subject to the following two

conditions:

- (1) This device may not cause harmful interference, and
 - (2) This device must accept any interference received, including interference that may cause undesired operation.
2. any Changes or modifications not expressly approved by the party responsible for compliance could void the user's authority to operate the equipment.

NOTE: This equipment has been tested and found to comply with the limits for a Class B digital device, pursuant to Part 15 of the FCC Rules. These limits are designed to provide reasonable protection against harmful interference in a residential installation.

This equipment generates uses and can radiate radio frequency energy and, if not installed and used in accordance with the instructions, may cause harmful interference to radio communications. However, there is no guarantee that interference will not occur in a particular installation. If this equipment does cause harmful interference to radio or television reception, which can be determined by turning the equipment off and on, the user is encouraged to try to correct the interference by one or more of the following measures:

Reorient or relocate the receiving antenna.

Increase the separation between the equipment and receiver.

Connect the equipment into an outlet on a circuit different from that to which the receiver is connected.

Consult the dealer or an experienced radio/TV technician for help.

FCC Radiation Exposure Statement

This equipment complies with FCC radiation exposure limits set forth for an uncontrolled environment. This equipment should be installed and operated with minimum distance 20cm between the radiator & your body

IC warning

This device contains licence-exempt transmitter(s)/receiver(s) that comply with Innovation, Science and Economic Development Canada's licence-exempt RSS(s). Operation is subject to the following two conditions:

- (1) This device may not cause interference; and
- (2) This device must accept any interference, including interference that may cause undesired operation of the device.

FCC/ IC Radiation Exposure Statement

This equipment complies with FCC and IC radiation exposure limits set forth for an uncontrolled environment. This equipment should be installed and operated with minimum distance 20cm between the radiator & your body

I. CONTENT

Prestige Facet 6B BT

- 1 active speaker
- 1 passive speaker
- 2 removable magnetic grids
- 8 rubber pads
- 1 user manual
- 1 remote control
- 1 speaker cable
- 1 power cable

Prestige Facet 14F BT

- 1 active speaker
- 1 passive speaker
- 2 removable bases
- 2 removable magnetic grids
- 8 screws
- 8 decoupling spikes
- 1 user manual
- 1 remote control
- 1 speaker cable
- 1 power cable

II. SETUP

SETUP PRESTIGE FACET 6B BT

Sticking the rubber pads

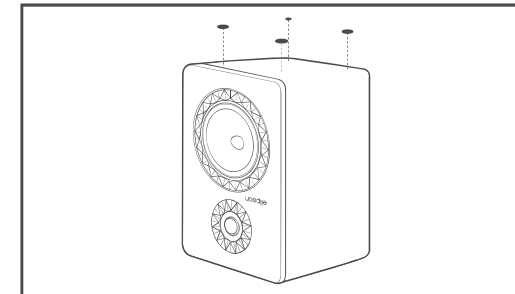

We recommend that you stick the rubber pads under the loudspeakers to protect itself.

SETUP PRESTIGE FACET 14F BT

1. Mounting the removable base on the cabinet

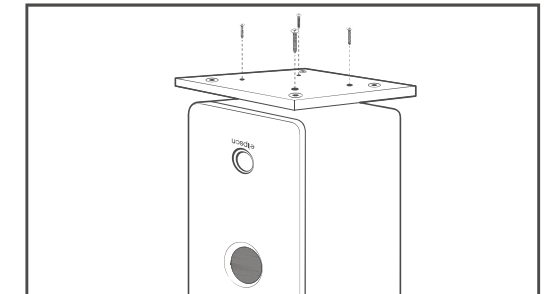

Carefully turn the cabinet over and place it on the packaging foams, or on a carpet, to avoid any damage of the top part. Take care not to damage the woodworking, the lacquered front or the drivers during this operation. Adjust the base on the cabinet and screw it using the four provided screws.

2. Putting spikes

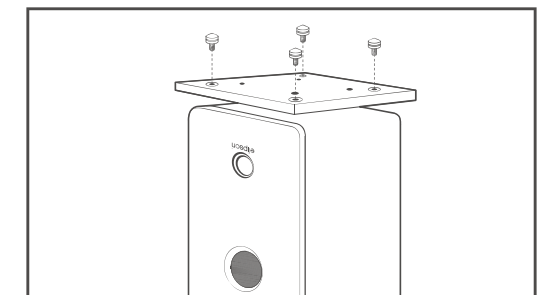

After mounting the base of the speaker, screw the spikes on it (no required tools).

Note : The presence of pads or decoupling spikes prevents vibrations to be transmitted to the floor.

III. FRONT AND REAR PANEL

PRESTIGE FACET 6B BT FRONT - ACTIVE

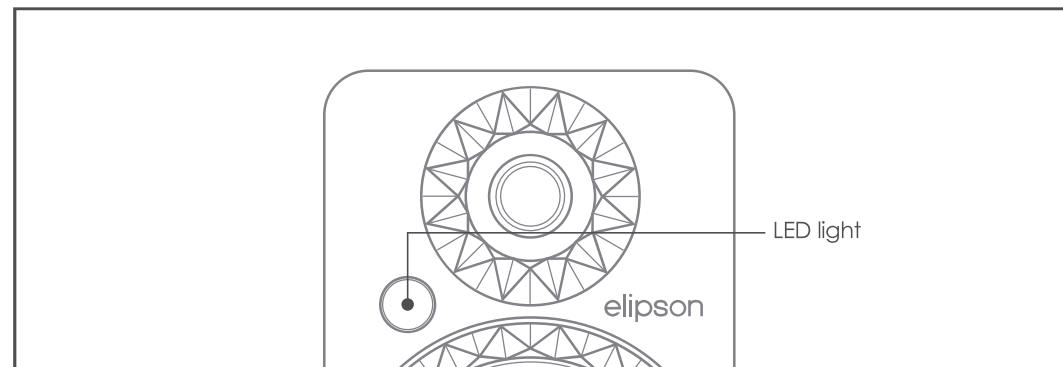

PRESTIGE FACET 14F BT FRONT - ACTIVE

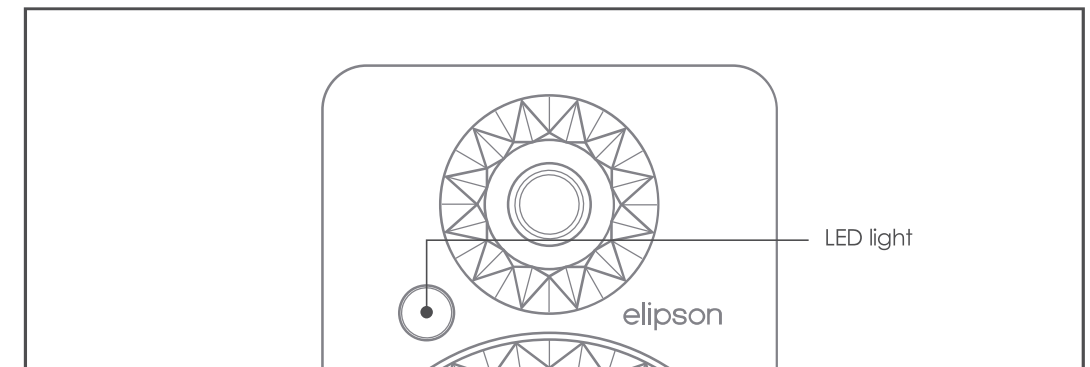

PRESTIGE FACET 6B BT REAR - ACTIVE

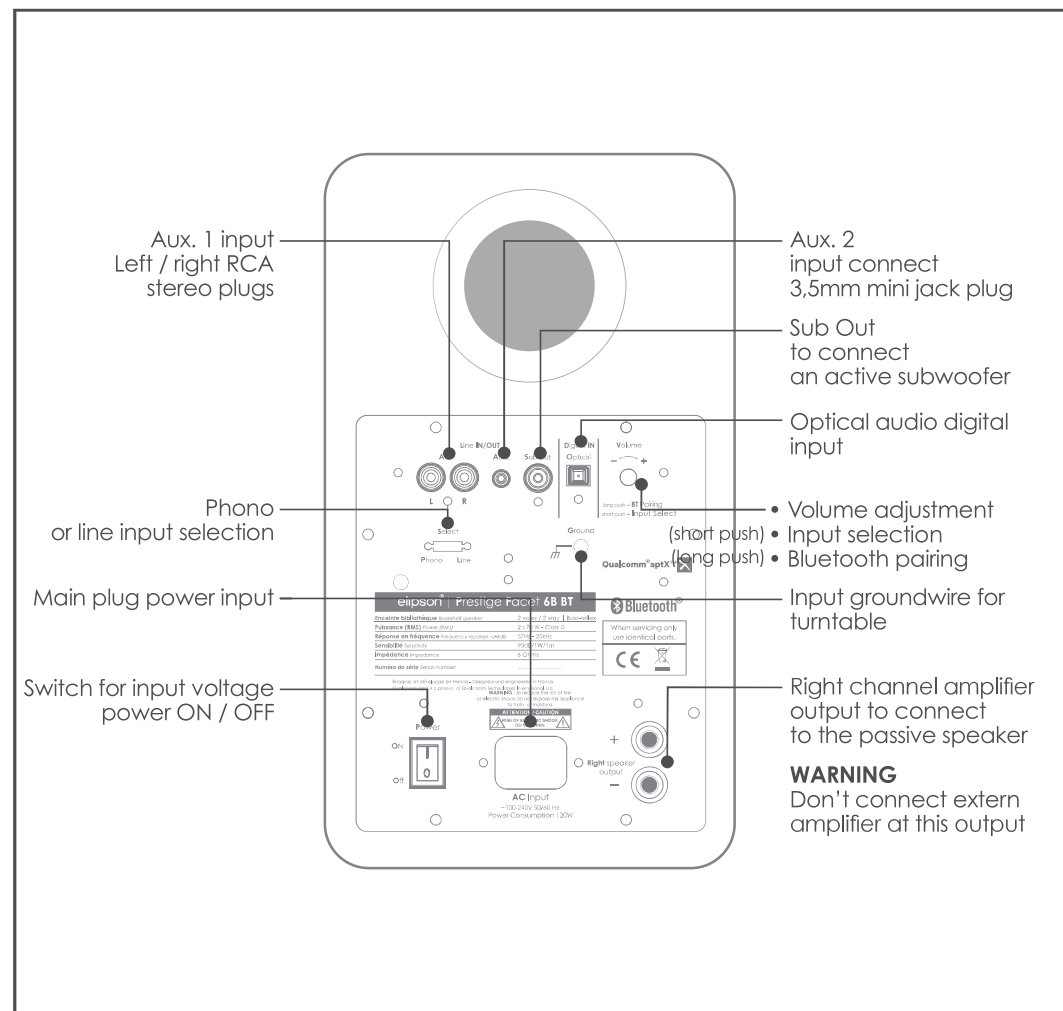

PRESTIGE FACET 14F BT REAR - ACTIVE

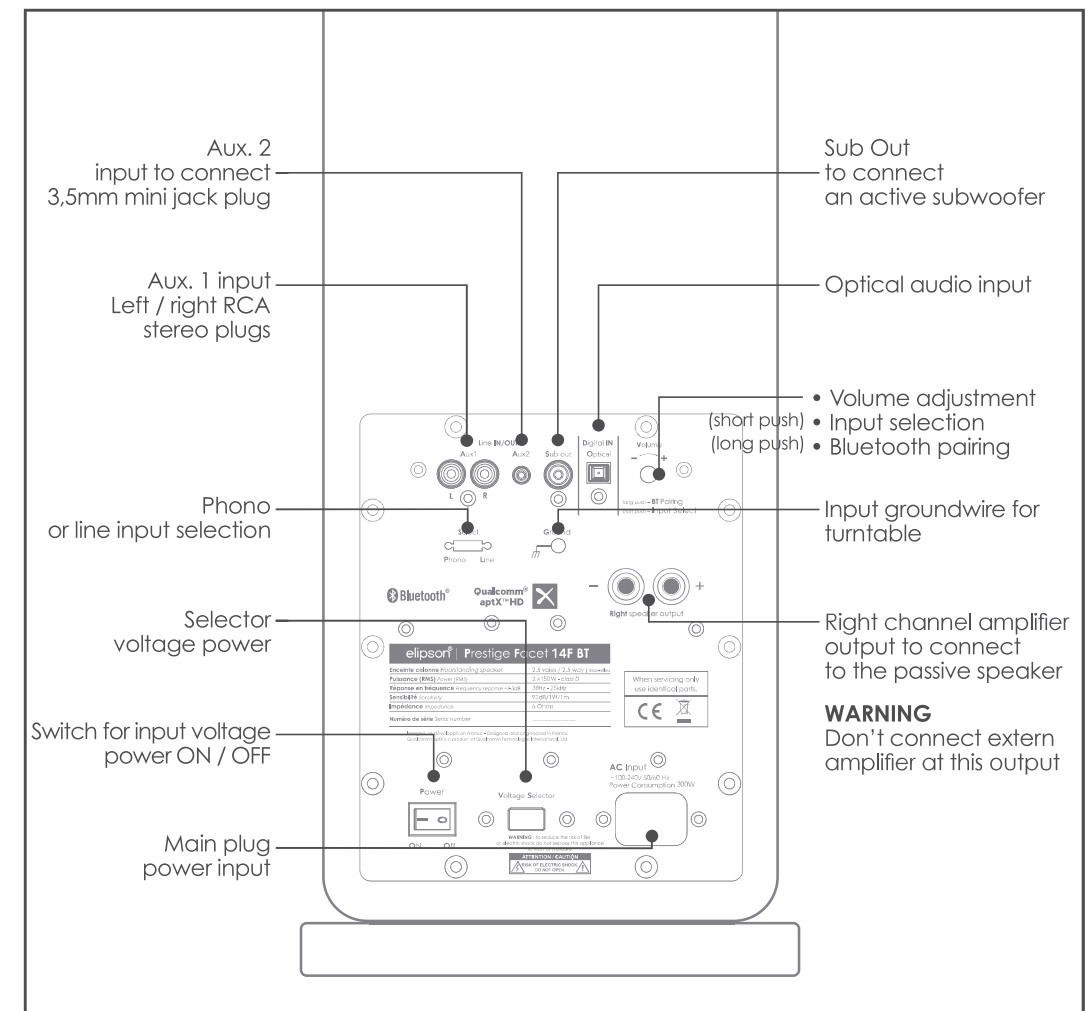

IV. STEREO SETUP

POSITION OF THE SPEAKERS

The Prestige Facet loudspeakers have been designed to reproduce all types of music as accurately as possible, provided that a few rules should be followed to optimise performance and achieve a realistic sound image.

Ideally, the speakers should be placed symmetrically in front of the listening position to form an equilateral triangle. The cabinets should be placed at the same height and the same distance from the rear wall and the adjacent side surfaces.

In order to optimise the setup of the speakers in your listening room, we recommend the following tests :

- Above all, you should avoid positioning the loudspeakers in the corners of your room. The result will be an artificial increase in the level of bass, masking the speed and details of this range.
- First, adjust the spacing of the two speakers in order to find the realistic balance between a wide sound image (wide apart speakers) and a sound image respecting the punctuality of the voices (close speakers).
- Secondly, move the speakers away from the rear wall by steps of 10 cm to find the balance between the depth of the sound image (far from the back wall) and the level of the extreme low frequencies (close to the back wall).
- Finally, adjust the loudspeakers orientation by turning them gradually toward the center of the listening area. If you leave the speakers parallel, you may want to bring them closer together, if you orient them more than 30°, you may increase their spacing.

Note : Floorstanding speakers (PF 14F BT) are naturally positioned at listening height, by their dimensions. It is recommended to place the PF 6B BT speakers on legs in order to satisfy the listening position.

Prestige Facet 6B BT setup

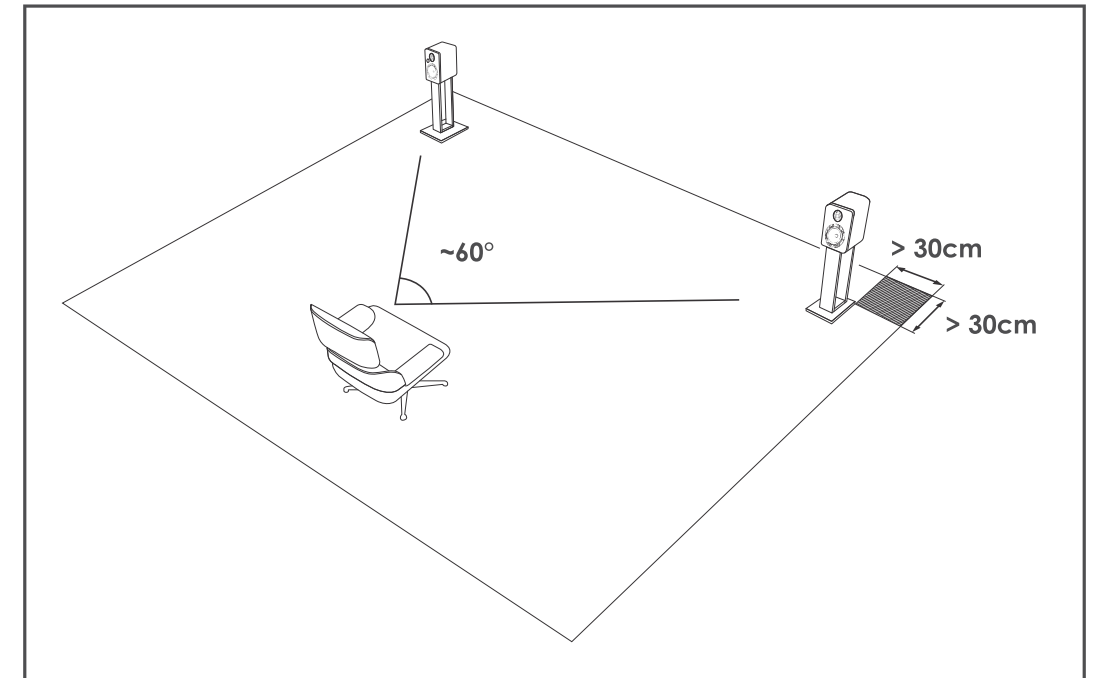

Prestige Facet 14F BT setup

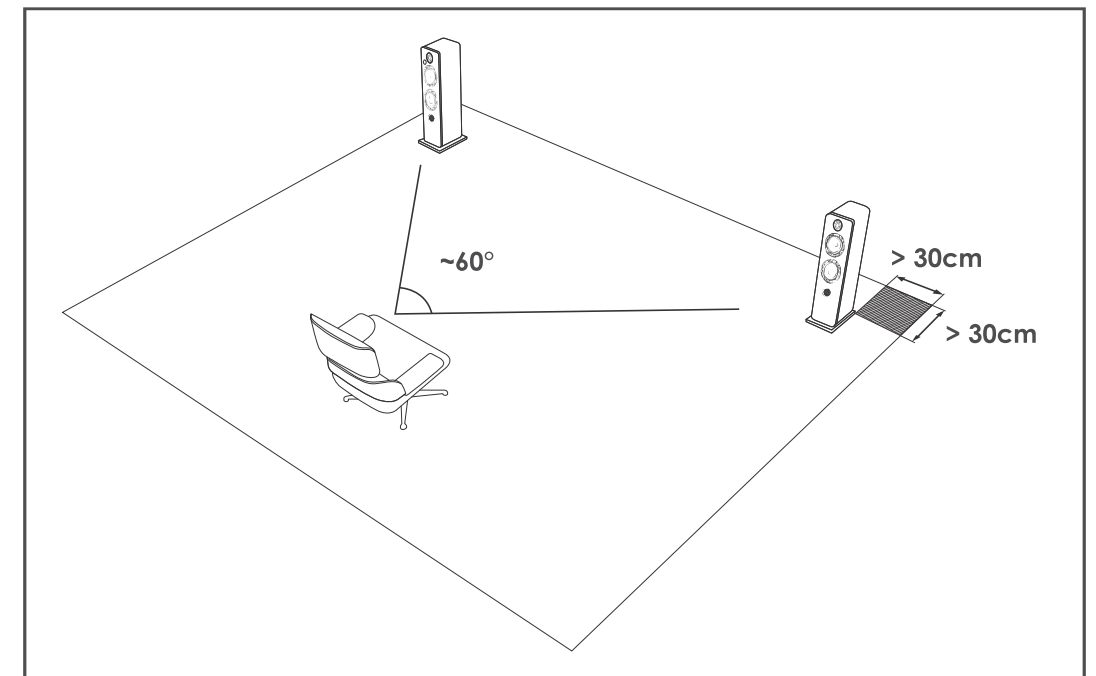

V. SPEAKER WIRING DIAGRAM

Connect the RED[+] and BLACK [-] terminals from the active speaker to the corresponding terminals on the passive speaker using the included speaker cable. The active speaker has to be placed on the left of your setup, the passive speaker on the right, to insure a good stereophonics quality. Sheath on cable must be stripped on all ends.

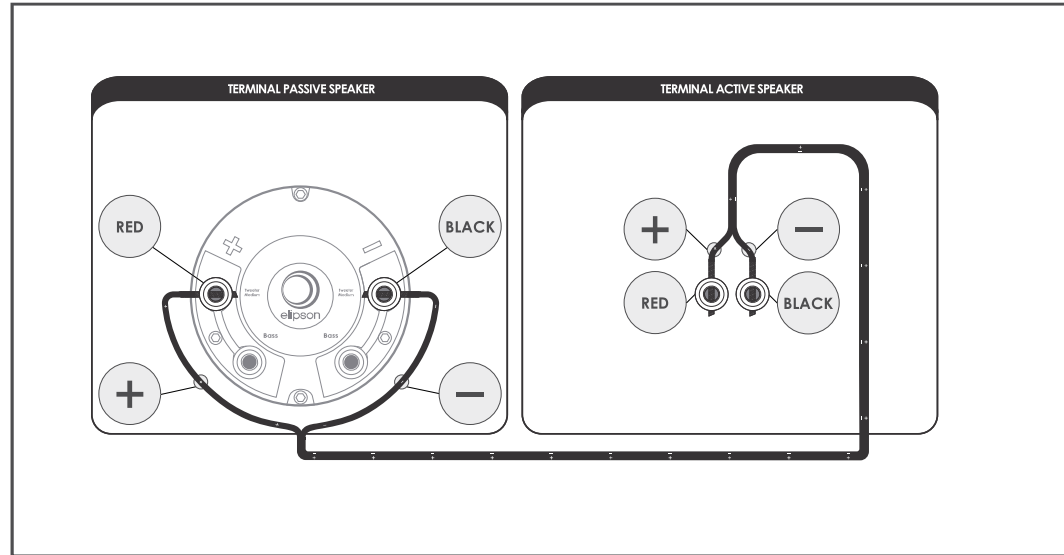

Note : Please do not connect two active speakers in stereo.

Connect the power supply cable.

⚠ WARNING : Do not connect extern amplifier to output active speaker

Prestige Facet 6B BT setup

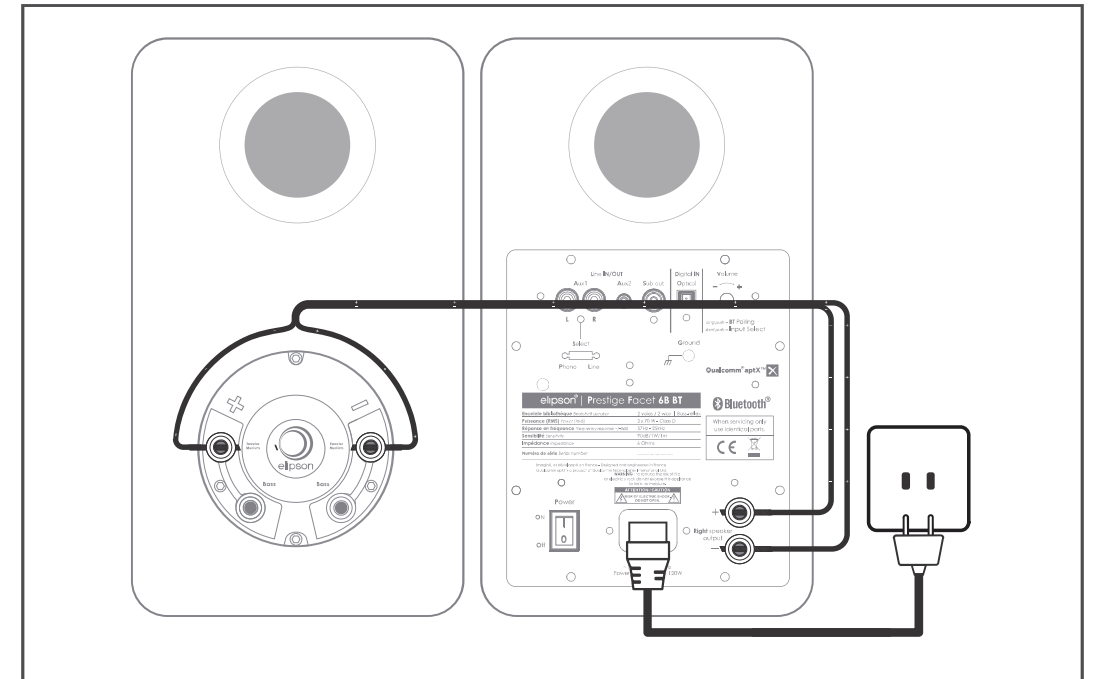

Prestige Facet 14F BT setup

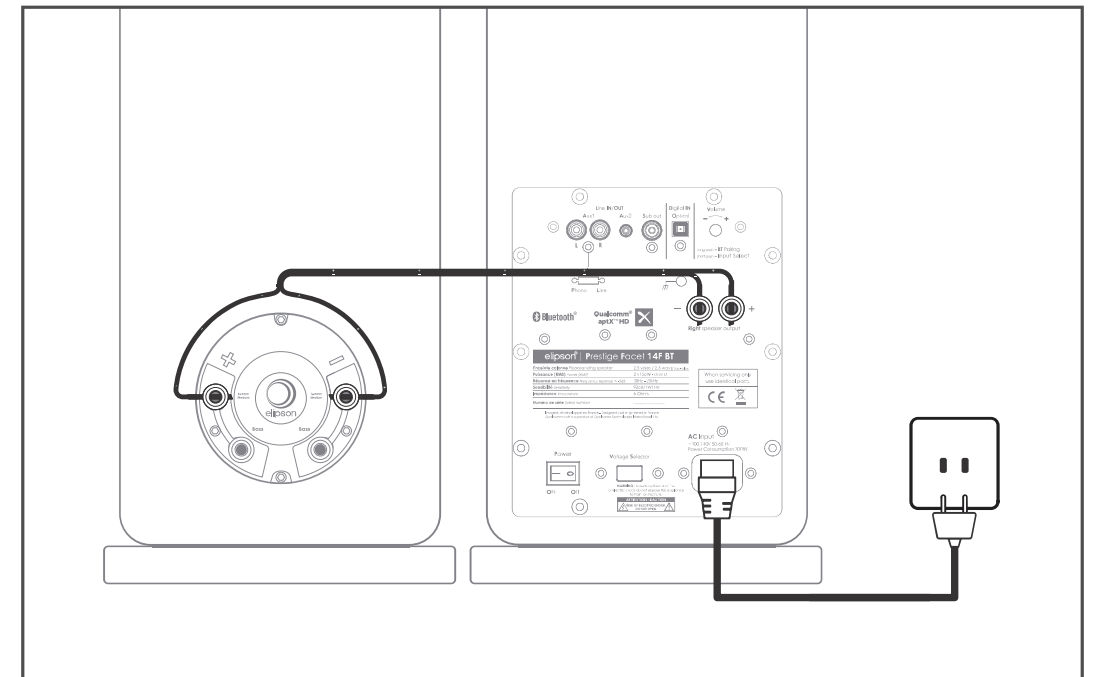

VI. REMOTE CONTROL

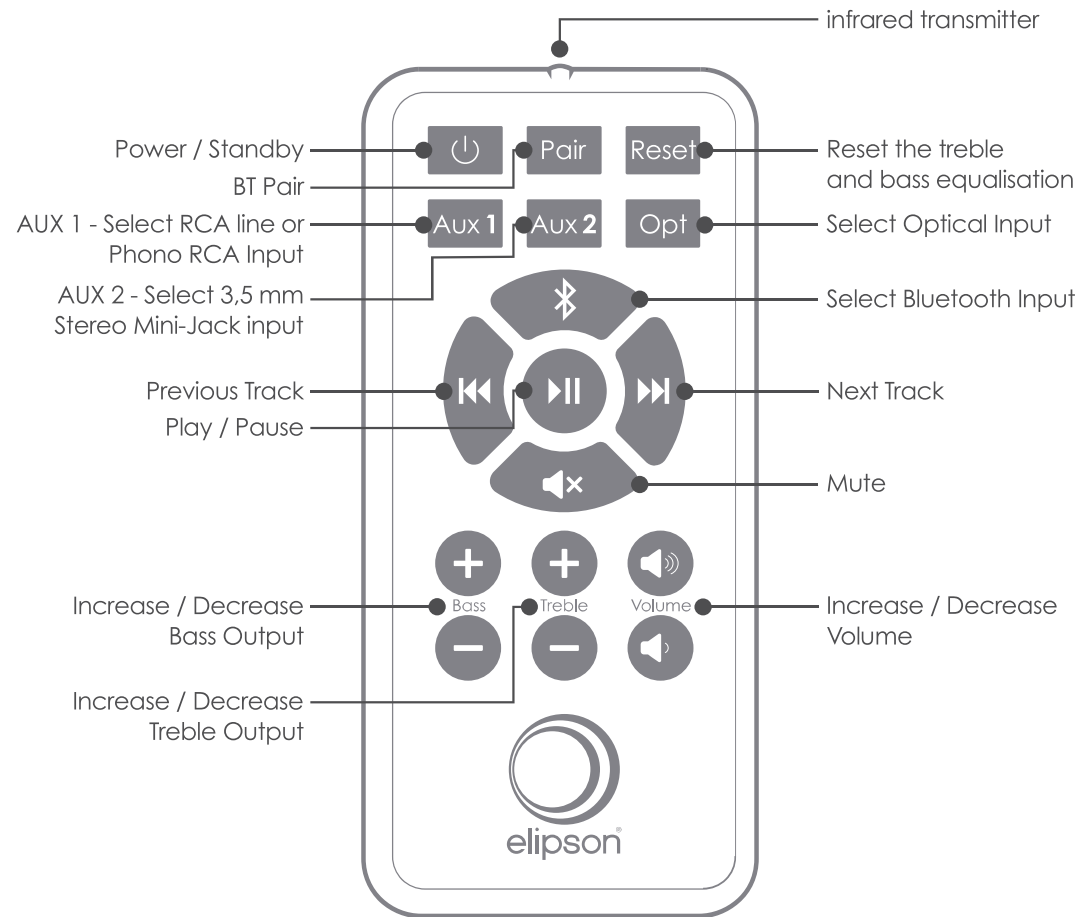

VII. PAIRING SPEAKER TO A BLUETOOTH SOURCE

PAIRING WITH REMOTE CONTROL

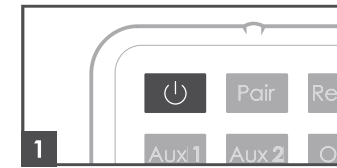

1 Turn on your Prestige Facet.

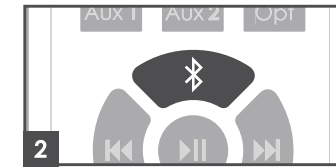

2 On the remote, press Bluetooth key.

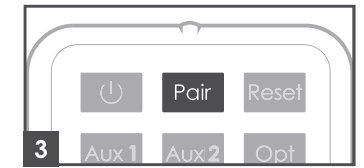

3 On the remote, select Pair key. This will put your Prestige Facet into detectable mode. The LED light will flash quickly.

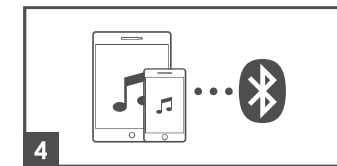

4 Please make sure that the Bluetooth function is enabled on your Bluetooth Audio Device.

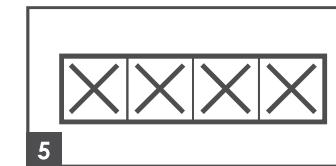

5 On your Bluetooth Audio Device, please select PF6BBT or PF14FBT.

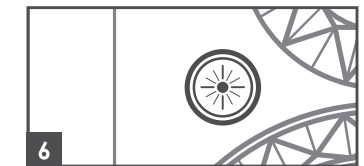

6 If pairing is successful, the LED light will stay solid.

PAIRING DIRECTLY ON THE ACTIVE SPEAKER

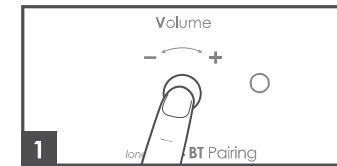

1 Turn on your Prestige Facet 6B BT or your Prestige Facet 14F BT with a short press on the volume control.

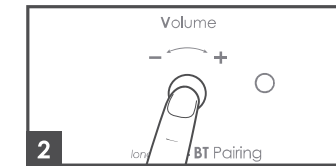

2 Press briefly several times the volume control until Bluetooth input is selected (LED light blinks slowly).

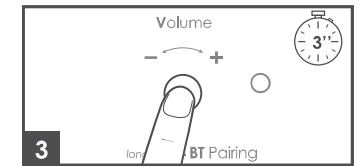

3 Press and hold the volume control. This will allow your Prestige Facet to be detected. The LED light will blink rapidly.

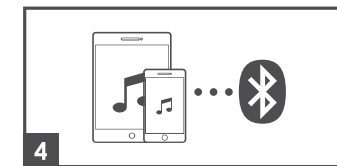

4 Make sure the Bluetooth function is enabled on your Bluetooth audio device.

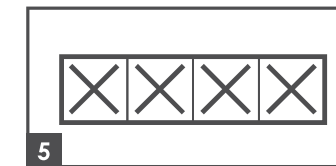

5 On your Bluetooth Audio Device, please select PF6BBT or PF14FBT.

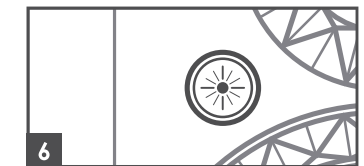

6 If pairing is successful, the LED light will stay solid.

VII. CONNECTING TO ANOTHER SOURCE

CHANGING THE INPUT

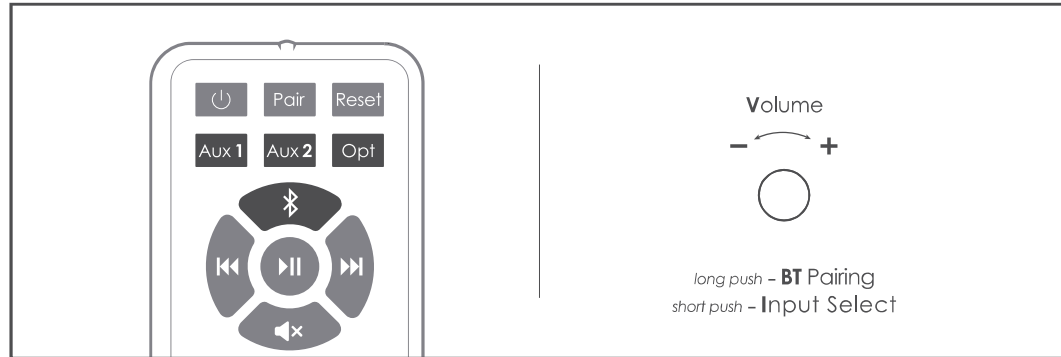

Inputs can be selected with the supplied remote control or with the «Volume Adjustment» on the back of the speaker.

AUX2 INPUT : JACK 3.5 MM

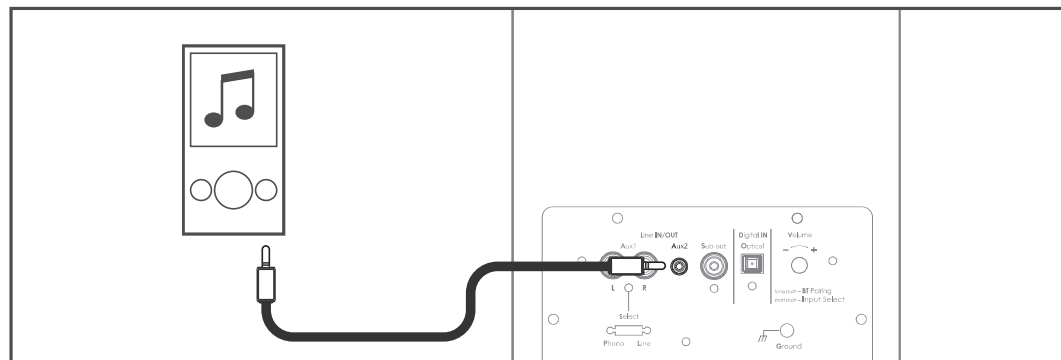

Plug our domestic devices (MP3, smartphones, laptop, ...) with help of 3.5mm jack to the AUX2 input
WARNING : When connecting audio cable, make sure that your speakers are turned off.

DIGITAL OPTICAL INPUT

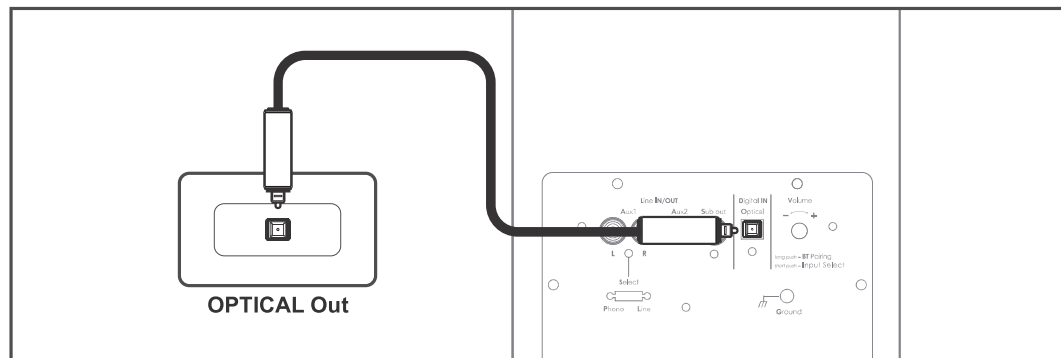

To use the «optical» input to connect our digital devices with help to optical cable. You can get a better audio quality with this input.

SUBWOOFER OUTPUT

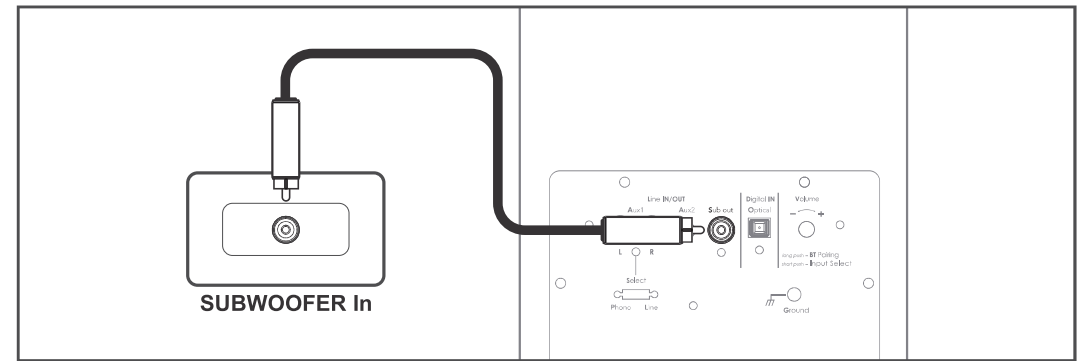

If you need more bass, you can connect a powered Subwoofer to your Prestige Facet by using an analog RCA cable.

AUX1 INPUT (LINE)

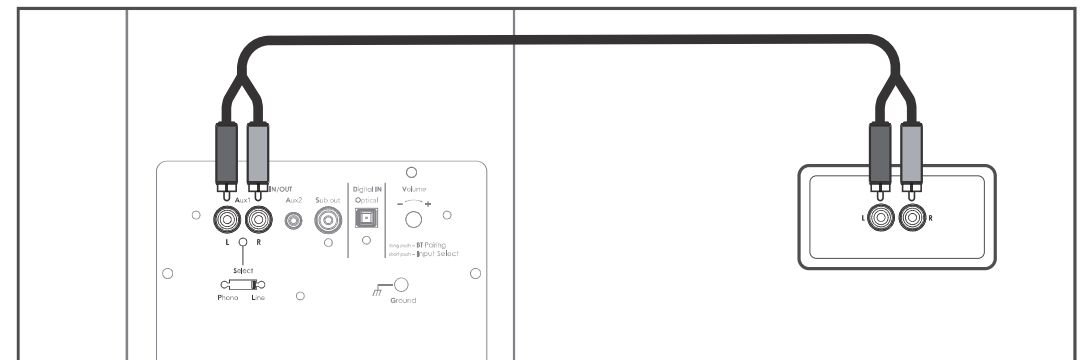

Connect any audio analog stereo source with RCA cable.
WARNING : When connecting audio cable, make sure that your speakers are turned off.

AUX1 INPUT (PHONO)

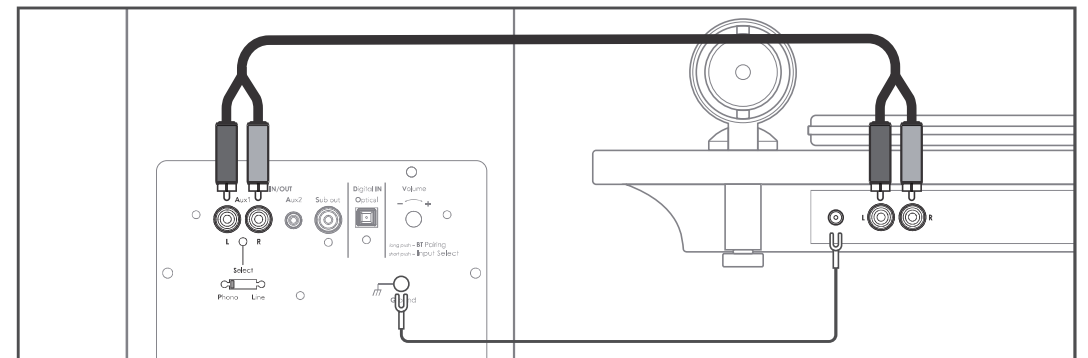

Connect your turntable to the RCA - AUX.1 input. Make sure that the phono or line input selector is in «PHONO» position.
WARNING : Connect the ground wire of your turntable to the ground phono input of the speaker

IX. USE

1. Burn-in period

When you take them out of the packaging, the Prestige Facet speakers are not yet able to reproduce with the same efficiency all the sound frequencies they are supposed to play. The Prestige Facet range loudspeakers are complex mechanical assemblies which need a period of adaptation ("burn-in") to operate at their best and become acclimatised to the temperature and humidity conditions of your environment. This burn-in period may last for some weeks, but you can quicken it by operating the speakers between 20 and 50 hours consecutively, on a moderate volume and broadcasting a radio station.

2. Cleaning instructions

To improve the lifetime of your speakers, we recommend regular cleaning. A soft cloth will be enough for dusting. If the speaker is stained, we recommend simply using a damp cloth with some mild soap if necessary. The lacquered front panel can be cleaned with a soft cloth and standard glass cleaning product.

Never use solvents, detergents, alcohol-based or corrosive products, scrapers or scourers to avoid any damage on the speaker surface.

Keep the loudspeakers away from sources of heat.

X. SPECIFICATIONS

	Prestige Facet 6B BT	Prestige Facet 14F BT
Type	Bookshelf 2 way - bass-reflex	Floorstanding 2½ way - bass-reflex
Power	2 x 70 W RMS - Class D	2 x 150 W RMS - Class D
Unit drivers	Tweeter 25 mm	Tweeter 25 mm
	Medium-Woofer 140 mm	Medium 170 mm
Frequency Response	57Hz - 25kHz	Woofers 170 mm
Sensitivity	90dB/1W/1m	38Hz - 25kHz
Inputs	RCA Line - RCA Phono 3,5mm jack - Optical S/PDIF	RCA Line - RCA Phono 3,5mm jack - Optical S/PDIF
Output	Subwoofer 20-220 Hz (+/-3dB)	Subwoofer 20-220 Hz (+/-3dB)
Dimensions	W176 x H298 x D223mm	W238 x H1026 X D325mm
Weight	Active : 7kg / Passive : 5,6kg	Active : 22kg / Passive : 20,5kg

WARNING

Packaging

The packaging (box and packing) was designed for effective protection of your Elipson loudspeakers and electronics during transportation and shipping. Please save them for later use. Protect the environment : if you wish to dispose of the packaging, please do so in the most environmentally responsible manner possible according to available measures (for example, sorted recycling). At the end of its life, this device should not be disposed of the same way as household refuse. It should be returned to a center for the recycling of electronic equipment.

This symbol on the product indicates that it has been designed so that it can be recycled according to specific procedures. You will therefore be making a significant contribution to the protection of the environment. This device respects the RoHS European directive. This means that it does not emit polluting substances when it is recycled (such as lead, mercury, cadmium, hexavalent chromium, polybromobiphenyles, polybromodiphenylethers).



Precautions for proper use

This product was designed according to rigorous norms and complies with safety standards. It should only be used under normal conditions as described below. Verify the electrical voltage before connecting it to a power source. This electronic device was designed to work in numerous countries. We advise you to hook it up completely before connecting it to the AC power source. Take care when unplugging the power cord. When you unplug the power cord from the power source, do so by pulling on the head of the plug rather than on the cable. If you do not expect to use this device for a prolonged period of time, you are advised to unplug it from the power source. Do not open the case. This device contains no parts that can be exchanged by the



user. Accessing the inside of this device's case can lead to electric shock. Any modification to the product will nullify the guarantee. If a foreign object or liquid falls into the case, contact your retailer to arrange for a technician to remove it from the device safely.

WARRANTY

Elipson speakers has been designed and manufactured to the highest quality standards. If something goes wrong with your product, Elipson or its authorized distributor / dealer will handle the service and repair under these limited warranty terms. This limited warranty is valid for a 2-year period from original purchase date from an authorized Elipson dealer.

Terms of limited warranty

The warranty is limited to equipment repair. Neither transportation, nor any other costs, nor any risk for removal, transportation and installation of products is covered by this warranty. The warranty is only valid for the original purchaser and is not transferable. The warranty will not apply in cases other than defects in materials and / or workmanship at the date of purchase and will not be applicable in the following cases :

- Damages caused by wrong or incorrect installation or connection.
- Damages caused by incorrect use, other use than the one described in the owner's manual, negligence, unauthorized modification or use of parts or of accessories that are not authorized by Elipson.
- Damages caused by unauthorized, unsuitable or faulty ancillary equipment.
- Damages caused by accidents, lightning, water, fire, heat or any other disturbance that would not be under Elipson control or responsibility.
- For products, which serial number has been altered, deleted, removed or made illegible.
- In case of repair and service executed by an unauthorized service person.



This warranty complements any national/federal/regional law obligations of local distributors/dealers and does not affect your statutory rights as a customer.

To claim repair under warranty

To claim repair or service under warranty you simply have to contact your local Elipson dealer, from whom your equipment has been purchased. To ensure that you will be able to ship your damaged product in correct manner, always retain the original packaging of your Elipson equipment. If you cannot contact your original dealer, or if you are using your Elipson product outside the purchase country, you should contact Elipson national distributor in the residence country, who will advise where the equipment can be serviced.

You can also visit our web site to check our contact information :
www.elipson.com

To validate your warranty, you need to produce, as a proof of purchase, your original purchase invoice specifying the date of purchase and stamped by your dealer.

	<p>The Bluetooth word mark and logos are owned by the Bluetooth SIG, Inc. and any use of such marks by Elipson is under license. Other trademarks and trade names are those of their respective owners.</p>
	<p>Qualcomm is a trademark of Qualcomm Incorporated, registered in the United States and other countries, used with permission. aptX is a trademark of Qualcomm Technologies International, Ltd., registered in the United States and other countries, used with permission.</p>

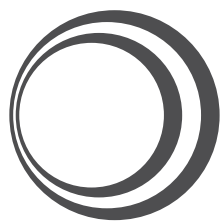

elipson®

www.elipson.com

19/10/2017