



Antenna Part Specification

Customer name:	Yingtong
Project name:	EPA361
Material category:	BT antenna
Version:	V1.0
Date:	2022.08.26



Contents

I: The report of passive data 3
II: 3D Active test report of antenna..... 8
III: Matching circuit 9
IV: Wave filter matching..... 10
V: Structure file..... 11

Change record			
Compile / change date	Reason for change	Changed content	Version
2022.08.26	First edition	First edition	V1.0



I: The report of passive data



Angilent E5071C

VSWR(S11) parameter (Left ear) :

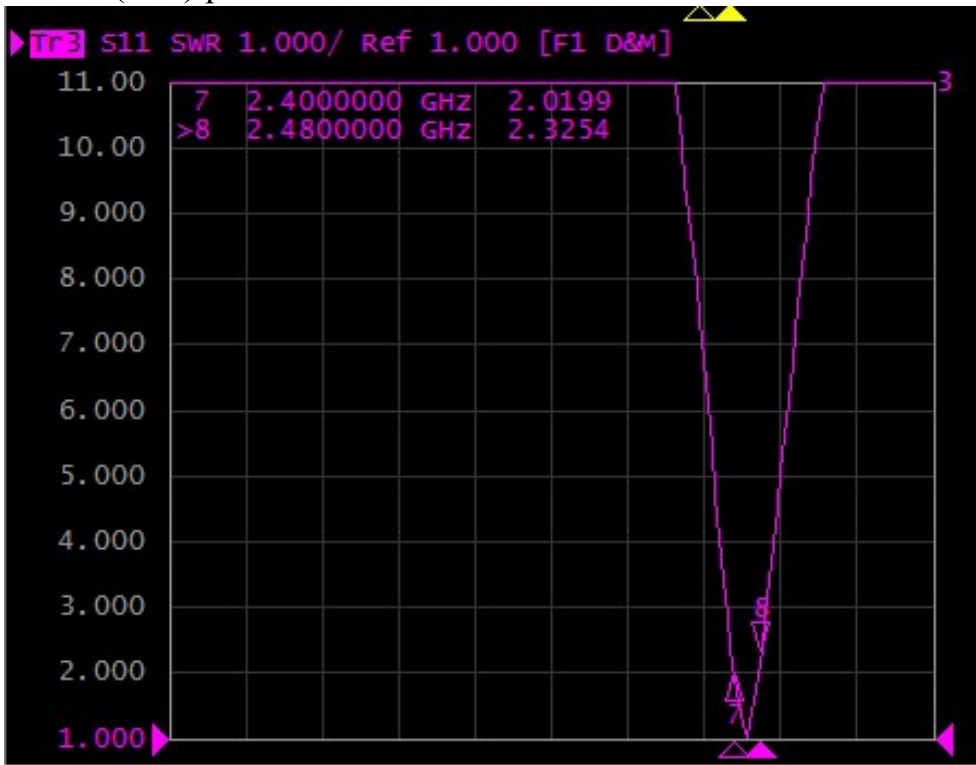

Efficiency:

2400-2480 MHz (Left ear)			
Frequency (MHz)	Gain (dBi)	Efficiency (dB)	Efficiency
2400	-1.1	-5.4	28.7%
2410	-0.8	-5.1	30.9%
2420	-0.8	-4.9	32.4%
2430	-0.9	-5.0	31.9%
2440	-0.9	-5.1	30.6%
2450	-0.9	-5.2	30.2%
2460	-1.3	-5.5	27.9%
2470	-1.3	-5.5	27.9%
2480	-1.6	-5.7	26.9%
Average value	-1.0	-5.3	29.7%



Antenna radiation pattern 2D:
Theta=90.00deg

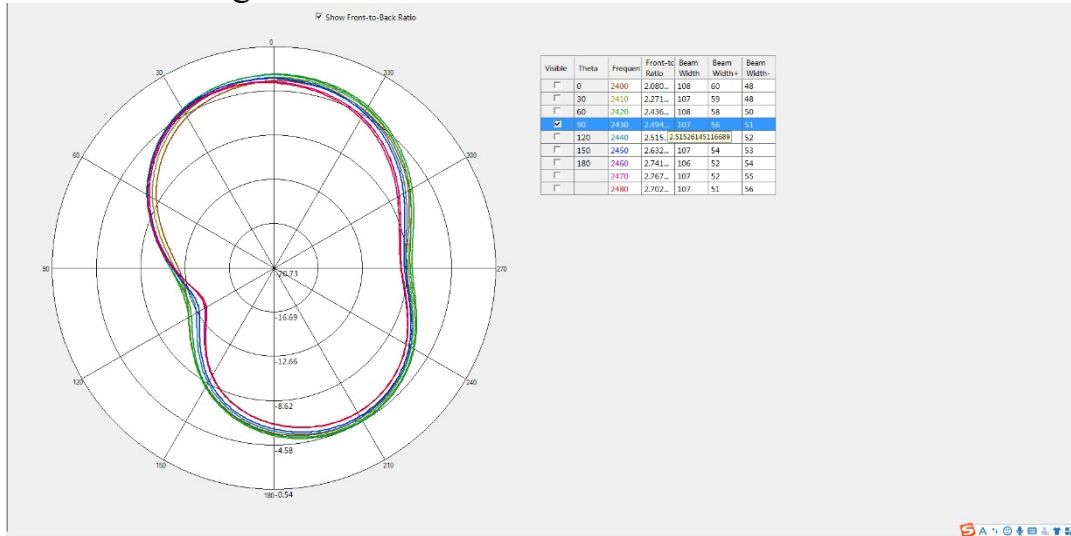

Phi=90.00deg

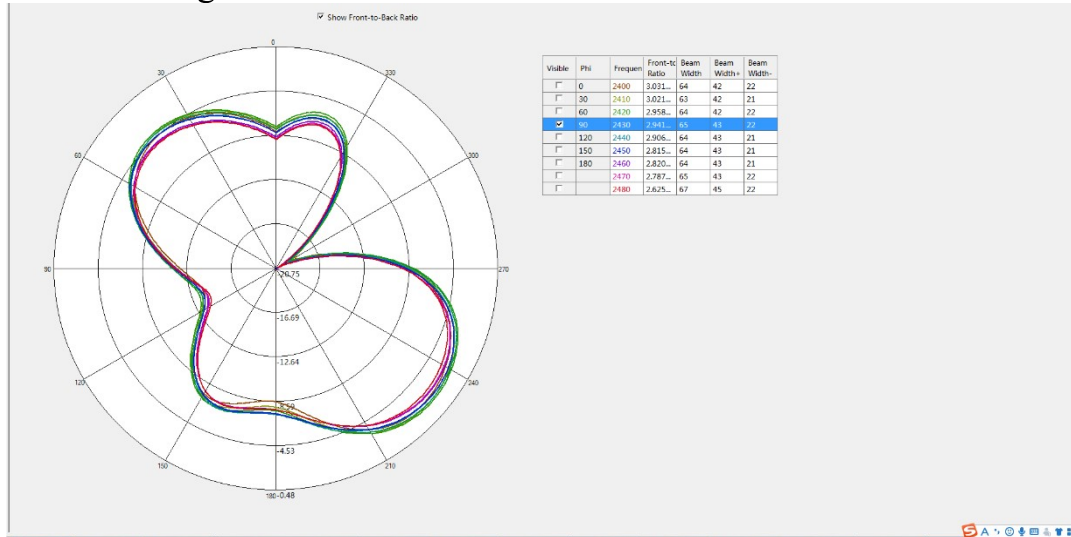

Phi=0.00deg

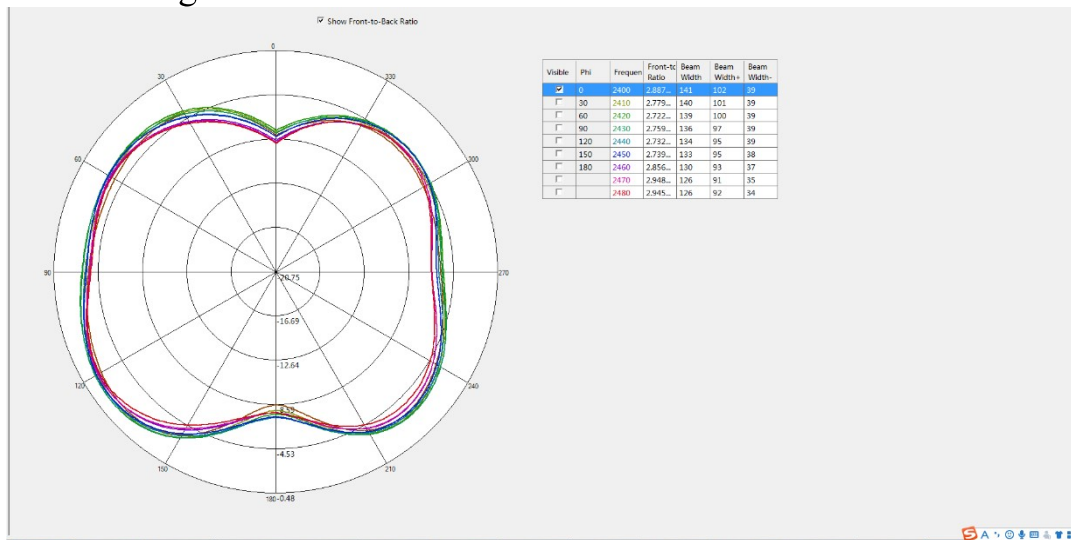



VSWR(S11) parameter (Right ear) :

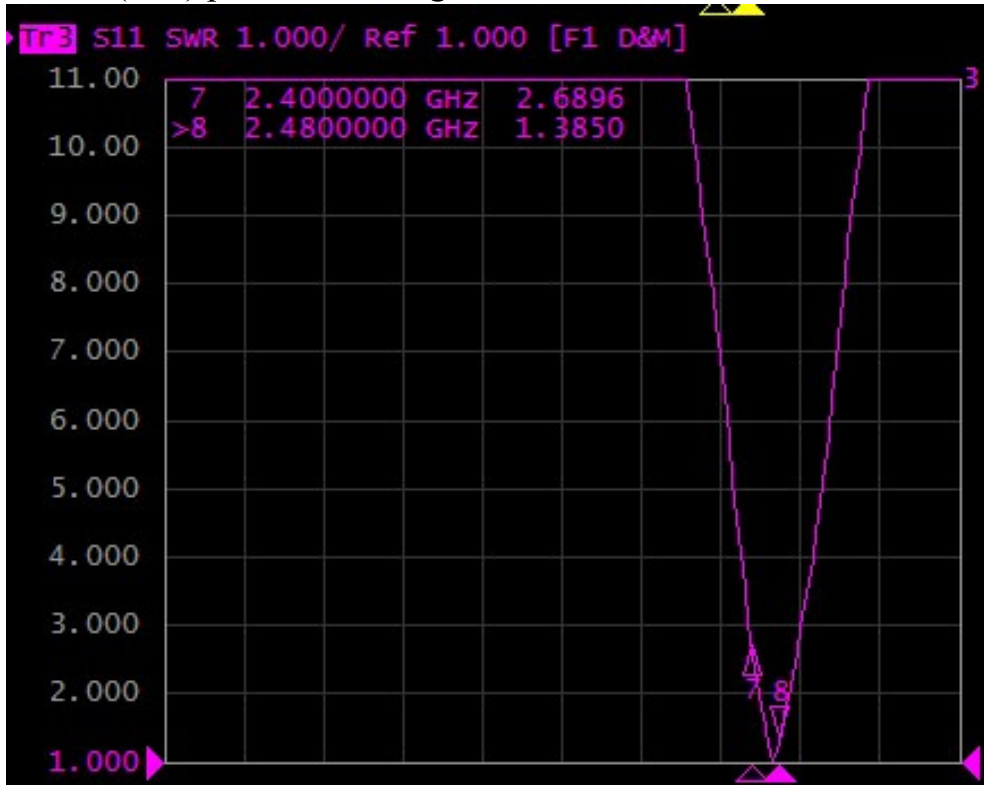

Efficiency:

2400-2480 MHz (Right ear)			
Frequency (MHz)	Gain (dBi)	Efficiency (dB)	Efficiency
2400	-1.3	-5.8	26.3%
2410	-1.0	-5.5	28.5%
2420	-0.8	-5.2	30.3%
2430	-0.8	-5.2	30.5%
2440	-0.9	-5.3	29.8%
2450	-0.9	-5.2	30.0%
2460	-1.2	-5.5	28.4%
2470	-1.0	-5.3	29.3%
2480	-1.1	-5.3	29.2%
Average value	-1.0	-5.4	29.1%



Antenna radiation pattern 2D:
Theta=90.00deg

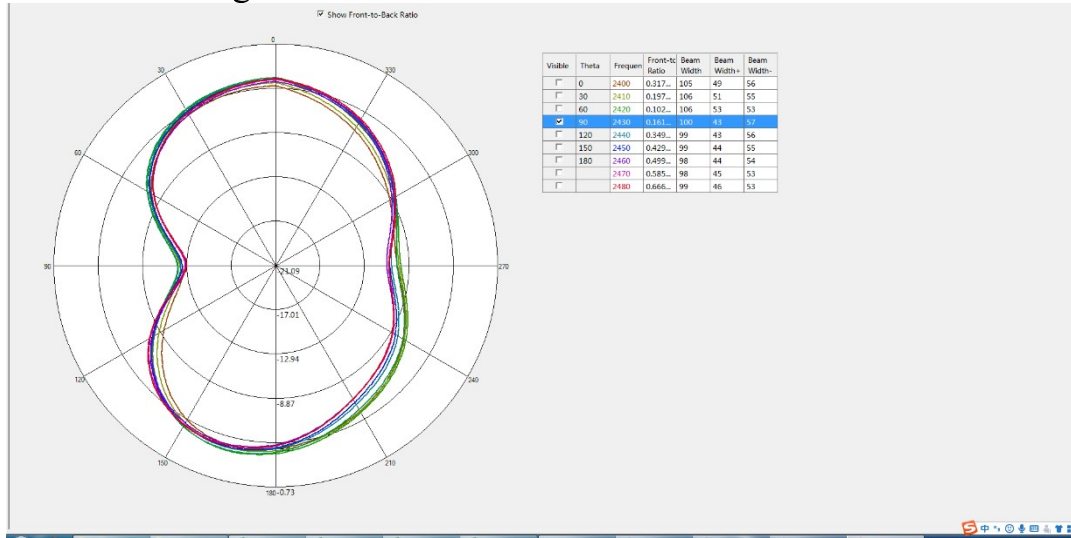

Phi=90.00deg

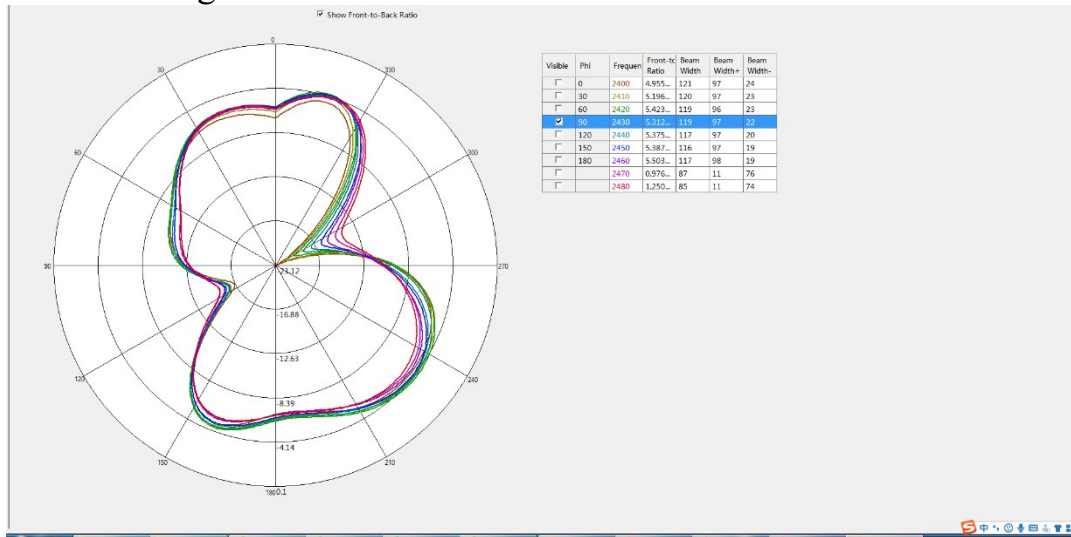

Phi=0.00deg

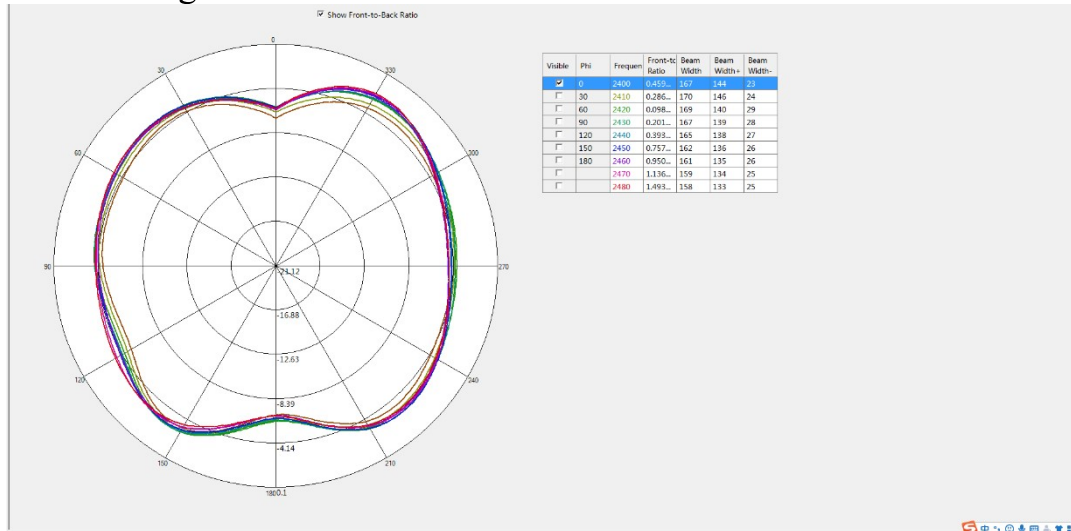



Antenna radiation pattern 3D (L) :

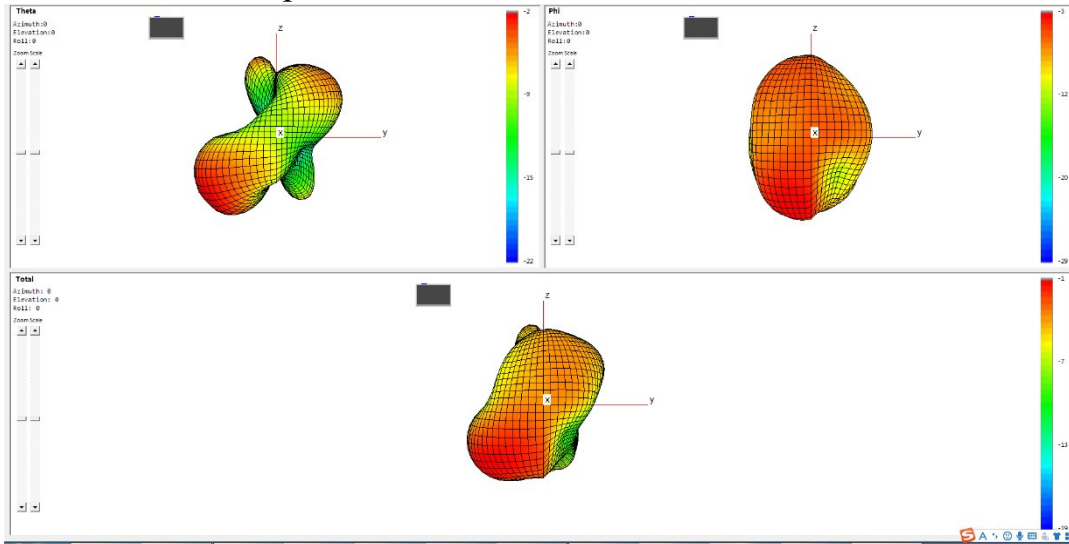

Antenna radiation pattern 3D (R) :

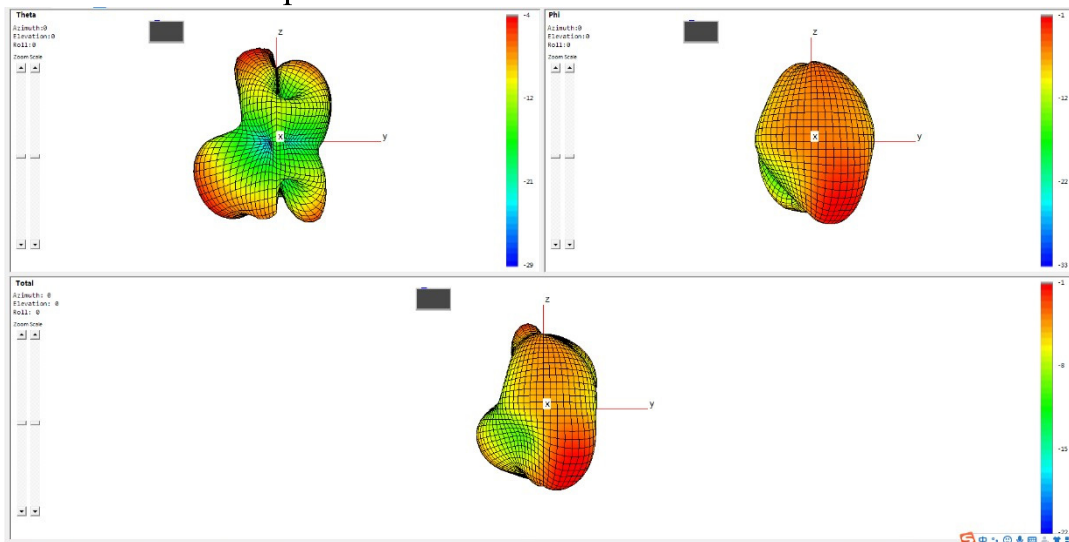



II: 3D Active test report of antenna

	Channel	TRP (dBm)	TIS (dBm)
L	CH 0	7.6	-89.6
	CH 39	8.2	-89.8
	CH 78	8.6	-90.3

	Channel	TRP (dBm)	TIS (dBm)
R	CH 0	6.4	-89.1
	CH 39	8.2	-90.3
	CH 78	8.6	-89.8



OTA Standard Chamber



III: Matching circuit

Left ear:

Element	Value
E1	2.7pF
E2	0Ω
E3	N/A

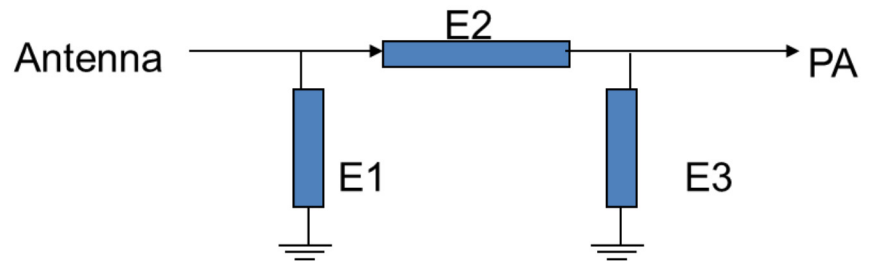

Right ear:

Element	Value
E1	2.7pF
E2	0Ω
E3	N/A

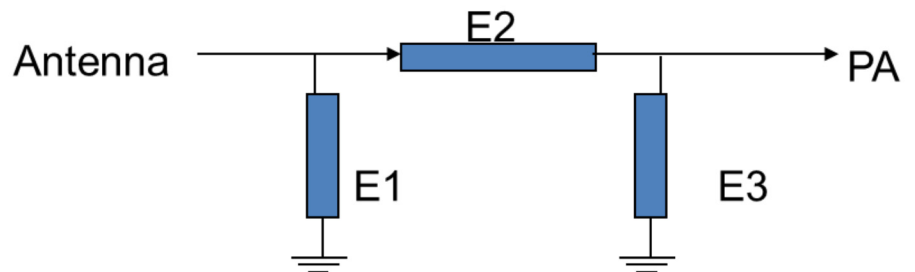



IV: Wave filter matching

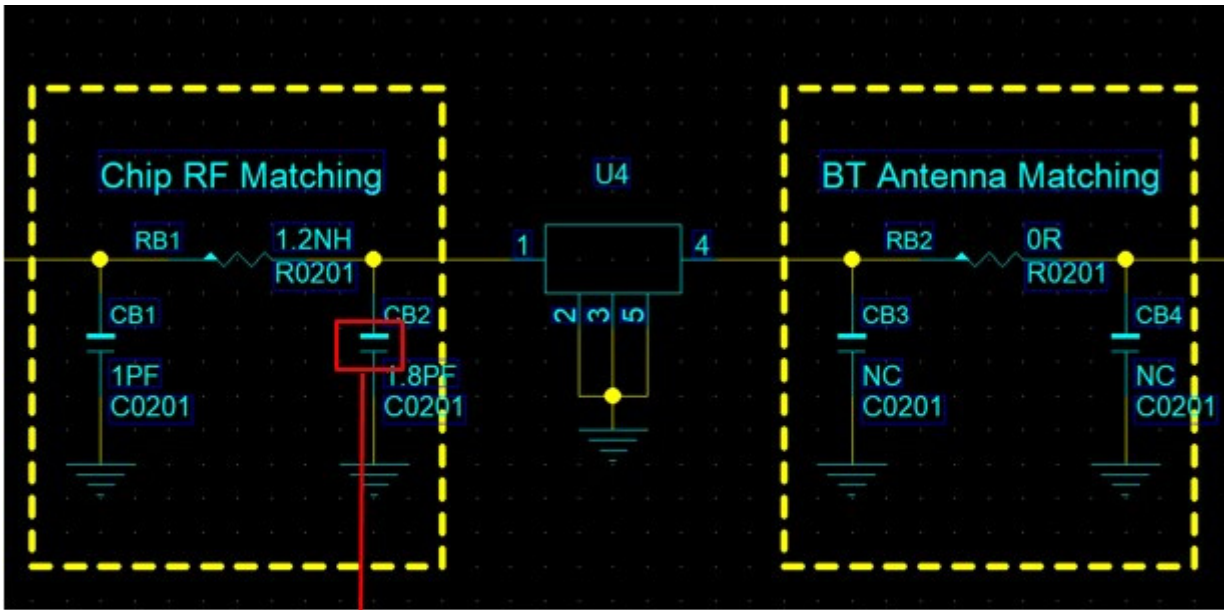

Remove the 1.8pF capacitor connected in parallel here



V : Structure file

