

Description

The HCA3216B2450C12S chip antenna is designed for WiFi/Bluetooth applications. This chip antenna has excellent stability consistently provide high signal reception efficiency.

Features

- Dimensions 3.2 x 1.6 x 0.5 (mm)
- Stable and reliable in performances
- Low temperature coefficient of frequency
- Low profile , compact size
- RoHS compliance
- SMT processes compatible

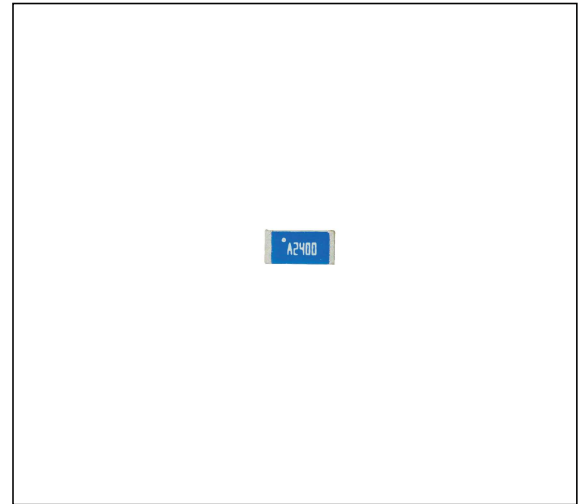

Applications

- Bluetooth earphone systems
- Hand-held devices when WiFi /Bluetooth functions are needed, e.g., Smart phone.
- IEEE802.11 b/g/n
- ZigBee
- Wireless PCMCIA cards or USB dongle

Shape and Dimensions / Recommended Pattern

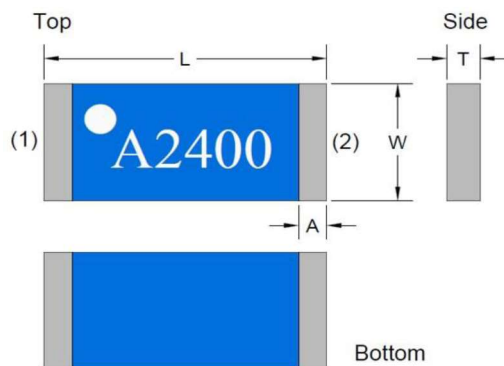

NO.	Terminal Name
[1]	Feeding point
[2]	GND

Dimensions in mm

TYPE	L	W	D	T
HCA3216B2450C12S	3.05±0.1	1.6±0.2	0.4±0.2	0.55±0.2

Electrical Specifications

Working Frequency Range	2400 ~ 2484 MHz
Peak Gain	2.58 dBi
Impedance	50 Ohm
Return loss	10 dB (Min)
Polarization	Linear
Azimuth Beamwidth	Omni-directional
Operation Temperature	-40 ~ 85 °C

Matching Circuit

With the following recommended values of matching and tuning components, the center frequencies will be about 2450 MHz at our standard 40x20 mm² evaluation board . However, these are reference values, may need to be changed when the circuit boards or part vendors are different.

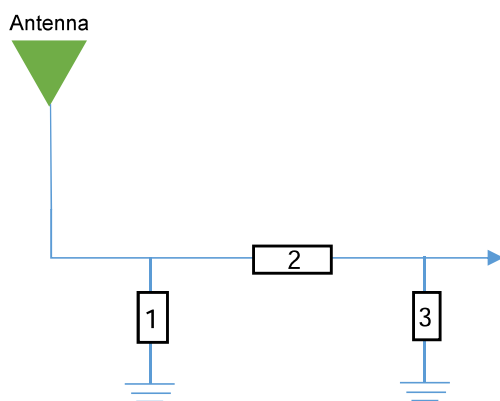

System Matching Circuit Component

Location	Description	Vendor
1	1.6pF, (0402)	MURATA
2	1.0nH, (0402)	
3	1.6pF, (0402)	MURATA

Dimensions and Recommended PC Board pattern

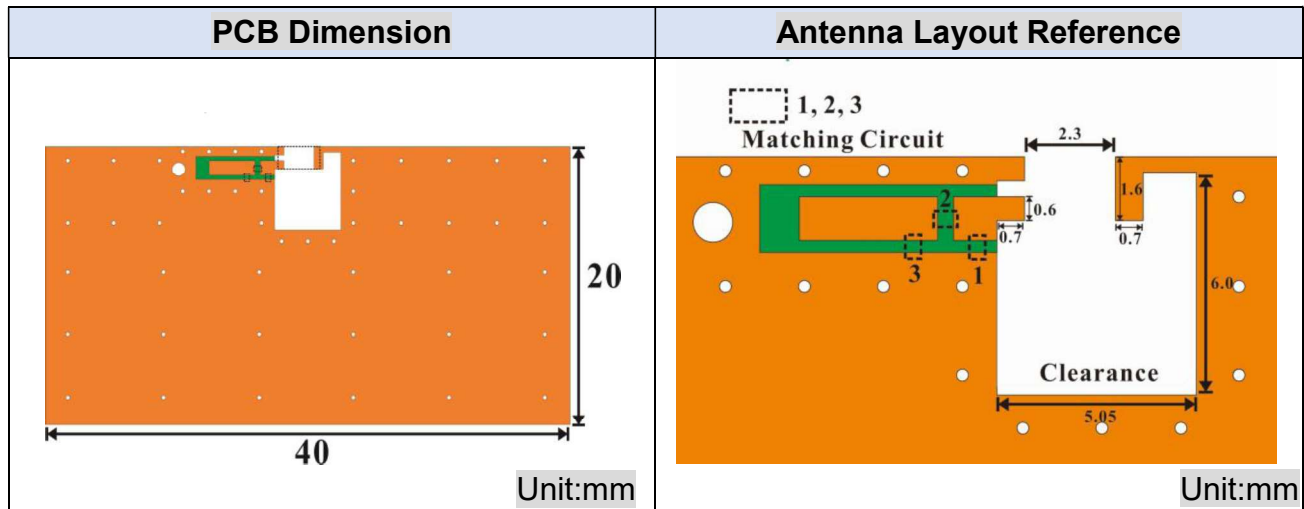

Return Loss & Radiation

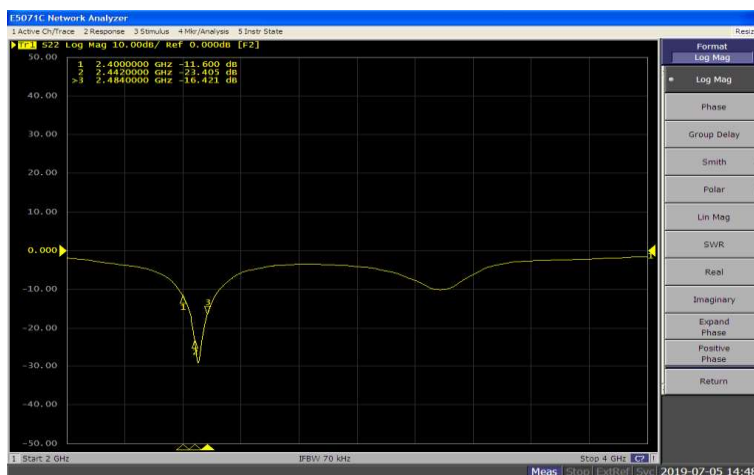

Frequency (MHz)	Return Loss (dB)
2400	11.6
2442	23.4
2484	16.4

3D Radiation

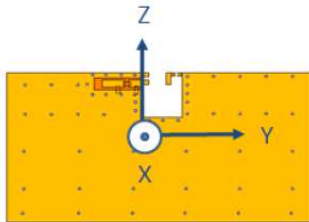
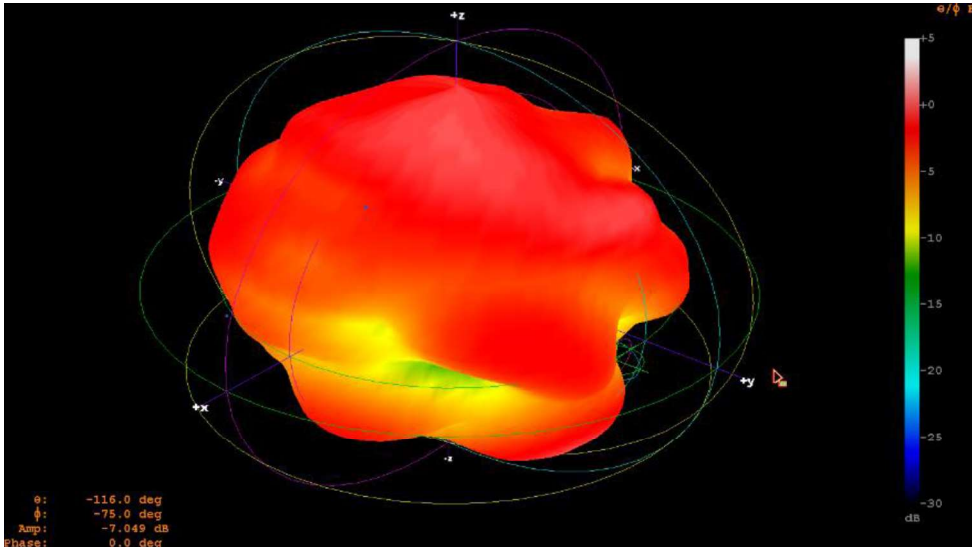

Frequency	2440 MHz
Peak Gain	2.58 dBi
Average Gain	-1.88 dBi
Efficiency	64.94 %

2D Radiation

Frequency : 2440 MHz

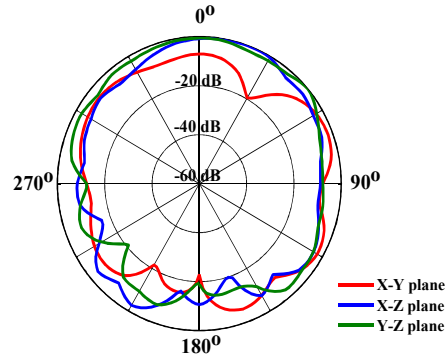

Pattern	Test Plane	Peak Gain (dBi)	Peak Gain Angle
1 Red	X-Y	-2.2	70°
2 Blue	X-Z	-0.247	22°
3 Green	Y-Z	-0.138	50°

Peak Gain & Efficiency

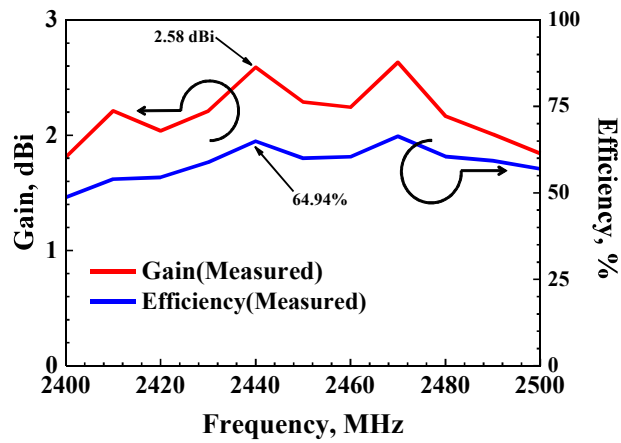

Frequency (MHz)	Gain (dBi)	Efficiency (%)
2400	1.81	48.67
2440	2.58	64.94
2480	2.16	60.46

Reliability Of Ferrite Multilayer Chip Bead

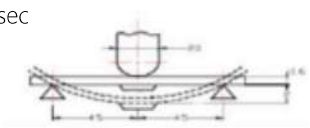
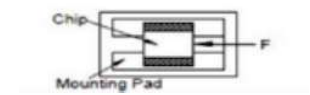
No	Item	Specification	Test Method
1-1-1	Board Flex	The forces applied on the right conditions must not damage the terminal electrode and the ferrite	Test device shall be soldered on the substrate Substrate Dimension: 100x40x1.6mm Deflection: 2.0mm Keeping Time: 60 sec 
1-1-2	Resistance to Soldering Heat	Meet the electrical Specification after test	Refer to MIL- STD-202 Method 210 Pre-heating:150-200°C ,60-100 sec Above 217°C,60-150 secs Peak Temperature: 260±5°C ,20-40 sec Cycles: 2 times
1-1-3	Solder ability	The electrodes shall be at least 95% covered with new solder coating	Refer to J-STD-002 Pre-heating:150 °C , 1min Solder Composition: Sn/Ag3.0/Cu0.5(Pb-Free) Solder Temperature: 245±5°C ,(Pb-Free) Immersion Time: 4 ±1sec
1-1-4	Terminal Strength Test	The chip must not damage the terminal electrode and the ferrite	Test device shall be soldered on the substrate Force 2N for 60± 1 seconds for 0603 series Force 5N for 60± 1 seconds for 1005 series Force 10N for 60± 1 seconds for 1608 series Force 1.8Kg for 60± 1 seconds for other series 
1-1-5	Vibration Test	Meet the electrical Specification after test	Refer to MIL-STD-202 Method 204 Vbration waveform: Sine waveform Vbration frequency: 10Hz~2000Hz Vbration acceleration:5g 10Hz-20Hz and back to 10Hz should be in 20 minutes Duration of test:12cycles each of 3 orientations 20 minutes for each cycle, 12 hr total Vibration axes:X, Y, & Z
1-1-6	Resistance to Solvent	There must be no change in appearance or ablation of marking	Refer to MIL-STD-202 Method 215 Inductors must withstand 6 mimutes of alcohol or water

Reliability Of Ferrite Multilayer Chip Bead

No	Item	Specification	Test Method
1-2-1	Temperature Cycle	Meet the electrical Specification afer test	Refer to JESD Method JA-104 Total cycles: 1000 cycles 30 minutes exposure to -40°C 30 minutes exposure to 125°C 1 min maximum transition between temperatures Measured after exposure in the room condition for 24hrs
1-2-2	Biased Humidity Resistance		Refer to MIL-STD-202 Method 103 Temperature: 85± 2 °C Relative Humidity : 85%/ Time:1000hrs Measured after exposure in the room condition for 24hrs
1-2-3	High Temperature Exposure (Storage)		Refer to MIL-STD-202 Method 108 Temperature: 125± 3°C /Relative Humidity: 0% Time:1000hrs Measured after exposure in the room condition for 24hrs
1-2-4	Low Temperature Exposure (Storage)	Meet the electrical Specification afer test	Refer to MIL-STD-202 Method 108 Temperature: -40± 3°C /Relative Humidity: 0% Applied Current: Rated Current Time:1000hrs Measured after exposure in the room condition for 24hrs

Slodering Conditions

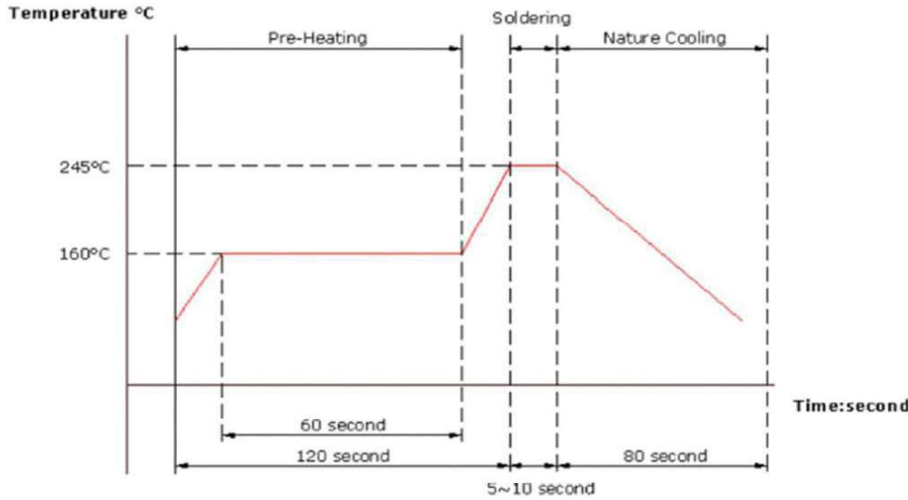

Lead Free Common Mode Fliter IR ReflowTemperature Profile

Packaging Specifications

Tape Dimensions

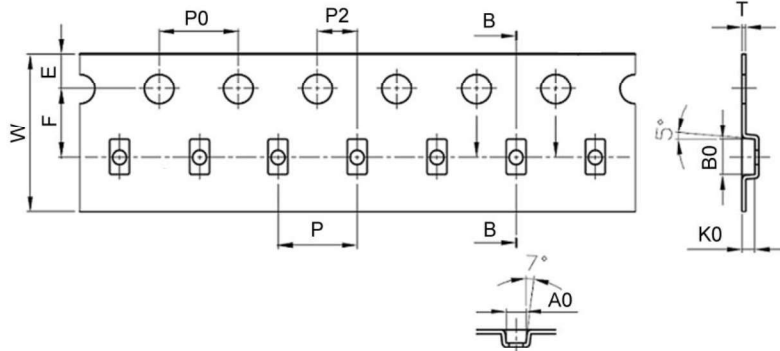

Reel Dimensions

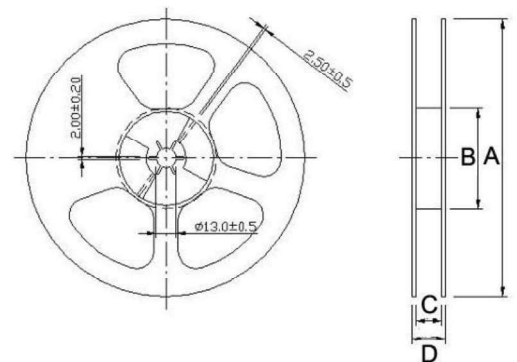

Dimensions in mm

TYPE	Tape Dimensions										Reel Dimensions				Quantity
	A0	B0	T	E	W	P	P0	P2	F	K0	A	B	C	D	PCS / REEL
HCA3216B2450C12S	1.9	3.50	0.75	1.75	8	4	4	2	3.5	0.73	178	60	8.4	11.5	5000