

# FCC Measurement/Technical Report on Hyper-thin Bluetooth IoT edge Wiliot Dual-Band IoT Pixel

Contains FCC ID: 2AXVQ-WILIOT2SB  
Contains IC: 22623-WILIOT2SB

**Report Reference:** MDE\_WILIOT\_2103\_FCC\_02

**Test Laboratory:**

7layers GmbH  
Borsigstrasse 11  
40880 Ratingen  
Germany



Deutsche  
Akkreditierungsstelle  
D-PL-12140-01-01  
D-PL-12140-01-02  
D-PL-12140-01-03

**Note:**

The following test results relate only to the devices specified in this document. This report shall not be reproduced in parts without the written approval of the test laboratory.

**7layers GmbH**

Borsigstraße 11  
40880 Ratingen, Germany  
T +49 (0) 2102 749 0  
F +49 (0) 2102 749 350

**Geschäftsführer/**

**Managing Directors:**

Frank Spiller  
Bernhard Retka  
Alexandre Norré-Oudard

**Registergericht/registered:**

Düsseldorf HRB 75554  
USt-Id.-Nr./VAT-No. DE203159652  
Steuer-Nr./TAX-No. 147/5869/0385

*a Bureau Veritas  
Group Company*

*www.7layers.com*

## TABLE OF CONTENTS

<b>1. Applied Standards and Test Summary</b>	<b>3</b>
1.1. Applied Standards	3
1.2. FCC-IC Correlation table	4
1.3. Measurement Summary /Signatures	5
<b>2. Revision History / Signatures</b>	<b>5</b>
<b>2. Administrative Data</b>	<b>6</b>
2.1. Testing Laboratory	6
2.2. Project Data	6
2.3. Applicant Data	6
2.4. Manufacturer Data	6
<b>3. Test Object Data</b>	<b>7</b>
3.1. General EUT Description	7
3.2. EUT Main components	8
3.3. Auxiliary Equipment	8
3.4. Ancillary Equipment	8
3.5. EUT Setups	9
3.6. Operating Modes / Test Channels	9
3.7. Product labelling	9
<b>4. Test Results</b>	<b>10</b>
4.1. Field strength of Fundamental / Radiated power output	10
4.2. Field Strength of Harmonics / Spurious radiated emissions	12
<b>5. Test Equipment</b>	<b>20</b>
<b>6. Antenna Factors, Cable Loss and Sample Calculations</b>	<b>22</b>
6.1. LISN R&S ESH3-Z5 (150 kHz – 30 MHz)	22
6.2. Antenna R&S HFH2-Z2 (9 kHz – 30 MHz)	23
6.3. Antenna R&S HL562 (30 MHz – 1 GHz)	24
6.4. Antenna R&S HF907 (1 GHz – 18 GHz)	25
6.5. Antenna EMCO 3160-09 (18 GHz – 26.5 GHz)	26
6.6. Antenna EMCO 3160-10 (26.5 GHz – 40 GHz)	27
<b>7. Photo Report</b>	<b>27</b>
<b>8. Measurement Uncertainties</b>	<b>28</b>

## 1. APPLIED STANDARDS AND TEST SUMMARY

### 1.1. APPLIED STANDARDS

#### **Type of Authorization**

Certification for an Intentional Radiator.

#### **Applicable FCC Rules**

Prepared in accordance with the requirements of FCC Rules and Regulations as listed in 47 CFR Ch.1 Parts 2 and 15 (10-1-20 Edition). The following subparts are applicable to the results in this test report.

Part 2, Subpart J - Equipment Authorization Procedures, Certification

Part 15, Subpart C – Intentional Radiators

§ 15.201 Equipment authorization requirement

§ 15.207 Conducted limits

§ 15.209 Radiated emission limits; general requirements

§ 15.249 Operation within the bands 902-928 MHz, 2400-2483.5 MHz, 5725-5875 MHz, and 24.0-24.25 GHz.

Note: ANSI C63.10–2013 is applied.

#### **Summary Test Results:**

**The EUT complied with all performed tests as listed in chapter 1.3 Measurement Summary / Signatures.**

1.2. FCC-IC CORRELATION TABLE

**Correlation of measurement requirements for general radio equipment and operation within the bands 902 – 928 MHz, 2400 – 2483.5 MHz, 5725 – 5825 MHz and 24.0 – 24.25 GHz from FCC and IC**

Measurement	FCC reference	IC reference
Conducted emissions on AC Mains	§ 15.207	RSS-Gen Issue 5: 8.8
Transmitter spurious radiated emissions	§ 15.209	RSS-Gen Issue 5: 6.13/8.9/8.10;
Field strength of Fundamental	§ 15.249	RSS-210 Issue 10: 7.2 RSS-210 Issue 10: Annex B.10
Operation within the bands 902-928 MHz, 2400-2483.5 MHz, 5725-5875 MHz, and 24.0-24.25 GHz.	§15.249	RSS-Gen Issue 5: 6.12, 8.9 RSS-210, Issue 10: Annex B.10

1.3. MEASUREMENT SUMMARY /SIGNATURES

**FCC Part 15, Subpart C § 15.249 (a)**

Field strength of Fundamental / Radiated power output			
The measurement was performed according to ANSI C63.10			
<b>OP-Mode, Frequency</b>	<b>Setup</b>	<b>Port</b>	<b>Final Result</b>
CW, high	S01_AA01	Enclosure	2013 passed

**FCC Part 15, Subpart C § 15.249 (a), § 15.35 (b), § 15.209**

Field Strength of Harmonics / Spurious radiated emissions			
The measurement was performed according to ANSI C63.10			
<b>OP-Mode, Frequency</b>	<b>Setup</b>	<b>Port</b>	<b>Final Result</b>
CW, high	S01_AA01	Enclosure	2013 passed

N/A not applicable (the EUT cannot be connected to the AC mains network)

2. REVISION HISTORY / SIGNATURES

Report version control			
Version	Release date	Change Description	Version validity
initial	2022-02-16	--	valid

COMMENT: -

The purpose of the test report is to verify the impact of a HW change. Thus not all applicable tests were performed.

---

(responsible for accreditation scope)  
Dipl.-Ing. Marco Kullik



---

(responsible for testing and report)  
Dipl.-Ing. Robert Machulec

## 2. ADMINISTRATIVE DATA

### 2.1. TESTING LABORATORY

Company Name: 7layers GmbH  
Address: Borsigstr. 11  
40880 Ratingen  
Germany

The test facility is also accredited by the following accreditation organisation:

Laboratory accreditation no: DAkKS D-PL-12140-01-01 | -02 | -03  
FCC Designation Number: DE0015  
FCC Test Firm Registration: 929146  
ISED CAB Identifier: DE0007; ISED#: 3699A

Responsible for accreditation scope: Dipl.-Ing. Marco Kullik

### 2.2. PROJECT DATA

Responsible for testing and report: Dipl.-Ing. Robert Machulec

Date of Report: 2022-02-16  
Testing Period: 2021-09-28

### 2.3. APPLICANT DATA

Company Name: Wiliot Inc.  
Address: 13500 Evening Creek Dr N, Suite 120  
San Diego  
United States

Contact Person: Mr. Roberto Sandre

### 2.4. MANUFACTURER DATA

Company Name: Please see Applicant Data  
Address:  
Contact Person:

### 3. TEST OBJECT DATA

#### 3.1. GENERAL EUT DESCRIPTION

Kind of Device product description	BTLE Transmitter operating in 2400 – 2483.5 MHz ISM frequency band.
Product name	Hyper-thin Bluetooth IoT edge
Type	Wiliot Dual-Band IoT Pixel
<b>Declared EUT data by the supplier</b>	
Voltage Type	DC
Normal Voltage	5V
Low Voltage	-
High Voltage	-
Normal Temperature	25 °C
Low Temperature	-40 °C
High Temperature	+85 °C
Specific product description for the EUT	The EUT is a tag with a Bluetooth® Low Energy Wireless Micro Controller Unit (MCU) that offers the ability to sense, compute and communicate using Bluetooth wireless communication technology. They do this without the need for a battery, and with a physical design and packaging that allows the integration onto stickers. The EUT is a transmit-only uni-directional device.
The EUT provides the following ports:	none
Special software used for testing	Wiliot Test Mode Host software, provided by the manufacturer
Antenna type / gain	Internal PCB loop antenna / -5.4dBi
Transmitter operating frequencies	2402 MHz / 2426 MHz / 2480 MHz

**The main components of the EUT are listed and described in Chapter 3.2.**

### 3.2. EUT MAIN COMPONENTS

Sample Name	Sample Code	Description
EUT A	DE1405003AA01	radiated sample
Sample Parameter	Value	
Serial No.	93B	
HW Version	Gen2 Tiki Dual band	
SW Version	Wiliot_Fw_P3	
Comment		

### 3.3. AUXILIARY EQUIPMENT

For the purposes of this test report, auxiliary equipment is defined as equipment which is used temporarily to enable operational and control features especially used for the tests of the EUT which is not used during normal operation or equipment that is used during the tests in combination with the EUT but is not subject of this test report. It is necessary to configure the system in a typical fashion, as a customer would normally use it. But nevertheless Auxiliary Equipment can influence the test results.

Device	Details (Manufacturer, Type Model, OUT Code)	Reason for using
Developmant board	Wiliot, PIB 2.0, WLT_015	

### 3.4. ANCILLARY EQUIPMENT

For the purposes of this test report, ancillary equipment is defined as equipment which is used in conjunction with the EUT to provide operational and control features to the EUT. It is necessary to configure the system in a typical fashion, as a customer would normally use it. But nevertheless Ancillary Equipment can influence the test results.

Device	Details (Manufacturer, HW, SW, S/N)	Description
---	---	---



### 3.5. EUT SETUPS

This chapter describes the combination of EUTs and ancillary equipment used for testing.

Setup No.	Combination of EUTs	Description
S01_AA01	EUT A	Used for all tests

### 3.6. OPERATING MODES / TEST CHANNELS

This chapter describes the operating modes of the EUTs used for testing.

Op. Mode	Description of Operating Modes	Remarks
CW	Continuous Wave signal	EUT transmits continuously an unmodulated signal
PM	Pulsed Modulated signal	EUT transmits a modulated signal with maximum possible duty cycle

#### BT LE Test Channels:

Channel:

Frequency [MHz]

low	mid	high
37	38	39
2402	2426	2480

Modulation: GFSK, BT = 0.5, 1 Msym/s

### 3.7. PRODUCT LABELLING

#### 3.7.1. FCC ID LABEL

Please refer to the documentation of the applicant.

#### 3.7.2. IC LABEL

Please refer to the documentation of the applicant.

#### 3.7.3. LOCATION OF THE LABEL ON THE EUT

Please refer to the documentation of the applicant.

#### 4. TEST RESULTS

##### 4.1. FIELD STRENGTH OF FUNDAMENTAL / RADIATED POWER OUTPUT

**Standard** FCC Part 15, Subpart C

**The test was performed according to ANSI C63.10–2013**

##### 4.1.1. TEST DESCRIPTION

Please refer to the description at sub-clause 4.2.1 esp. item no. 3. (Above 1 GHz)

##### 4.1.2. TEST REQUIREMENTS / LIMITS

FCC Part 15, Subpart C, §15.249

(a) Except as provided in paragraph (b) of this section, the field strength of emissions from intentional radiators operated within these frequency bands shall comply with the following:

Fundamental frequency	Field strength of fundamental (millivolts/meter)	Field strength of harmonics (microvolts/meter)
902-928 MHz	50 (94.0 dB $\mu$ V/m)	500 (54.0 dB $\mu$ V/m)
2400-2483.5 MHz	50 (94.0 dB $\mu$ V/m)	500 (54.0 dB $\mu$ V/m)
5725-5875 MHz	50 (94.0 dB $\mu$ V/m)	500 (54.0 dB $\mu$ V/m)
24.0-24.25 GHz	250 (108.0 dB $\mu$ V/m)	2500 (68.0 dB $\mu$ V/m)

Used conversion factor: Limit (dB $\mu$ V/m) = 20 log (Limit ( $\mu$ V/m)/1 $\mu$ V/m)

(c) Field strength limits are specified at 3 meters.

(e) As shown in §15.35(b), for frequencies above 1000 MHz, the field strength limits in paragraphs (a) and (b) of this section are based on average limits. However, the peak field strength of any emission shall not exceed the maximum permitted average limits specified above by more than 20 dB under any condition of modulation.

#### 4.1.3. TEST PROTOCOL

Temperature: 23 °C  
Air Pressure: 1011 hPa  
Humidity: 38 %

Op. Mode	Setup	Port
CW	S01_AA01	Enclosure

Frequency [MHz]	CAverage (dB $\mu$ V/m)	Limit [dB $\mu$ V/m]	Margin to Limit [dB]	Remarks
2480	78.0	94	16.0	No duty cycle correction applied

Notes: -

#### 4.1.4. MEASUREMENT PLOTS

Radio Technology = BTLE, Operating Frequency = High (S01\_AA01)

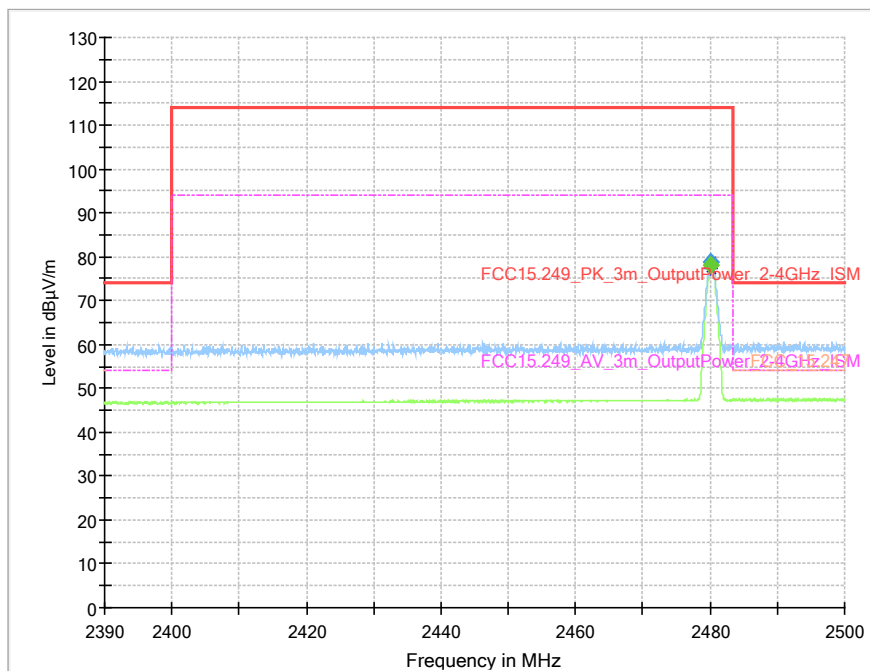

#### Final Result

Frequency (MHz)	MaxPeak (dB $\mu$ V/m)	CAverage (dB $\mu$ V/m)	Limit (dB $\mu$ V/m)	Margin (dB)	Meas. Time (ms)	Bandwidth (kHz)	Height (cm)	Pol	Azimuth (deg)	Elevation (deg)	Corr. (dB/m)
2480.200	---	78.0	93.98	15.94	1000.0	1000.000	150.0	V	-85.0	92.0	35.1

#### 4.1.5. TEST EQUIPMENT USED

- Radiated Emissions

## 4.2. FIELD STRENGTH OF HARMONICS / SPURIOUS RADIATED EMISSIONS

Standard **FCC Part 15 Subpart C**

**The test was performed according to ANSI C63.10–2013**

### 4.2.1. TEST DESCRIPTION

The test set-up was made in accordance to the general provisions of ANSI C63.10 in a typical installation configuration. The measurements were performed according the following sub-chapters of ANSI C63.10:

- < 30 MHz: Chapter 6.4
- 30 MHz – 1 GHz: Chapter 6.5
- > 1 GHz: Chapter 6.6 (procedure according 6.6.5 used)

The measurement procedure is implemented into the EMI test software EMC32 from R&S. Exploratory tests are performed at 3 orthogonal axes to determine the worst-case orientation of a body-worn or handheld EUT. The final test on all kind of EUTs is also performed at 3 axes. A pre-check is performed while the EUT is powered.

#### **Below 1 GHz:**

The Equipment Under Test (EUT) was set up on a non-conductive table in the semi-anechoic chamber. The influence of the EUT support table that is used between 30–1000 MHz was evaluated.

#### **1. Measurement up to 30 MHz**

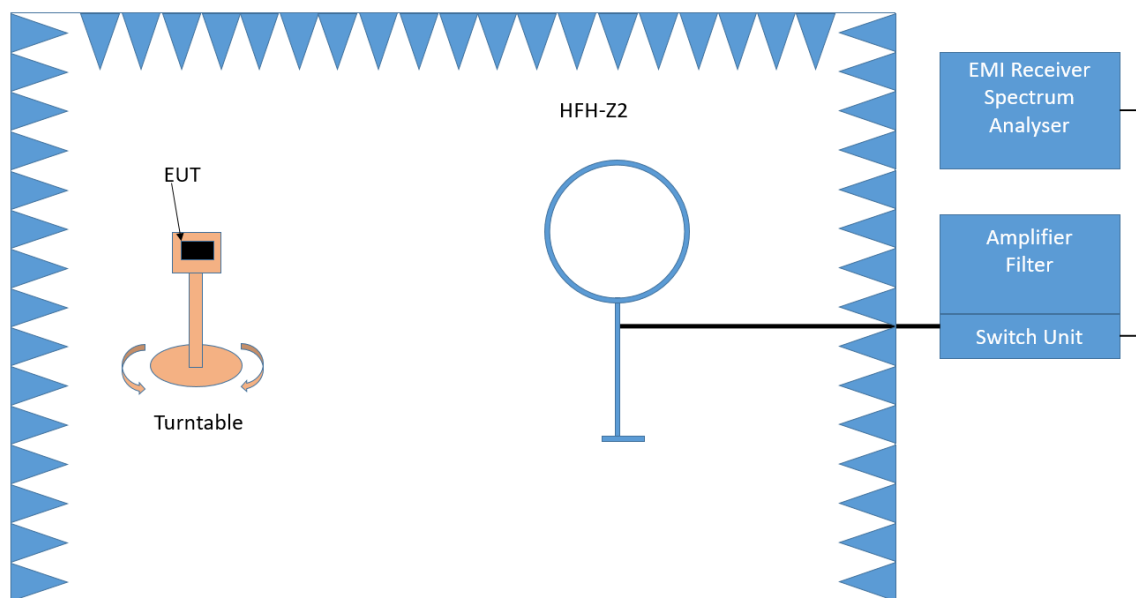

Test Setup; Spurious Emission Radiated (SAC), 9 kHz – 30 MHz

The Loop antenna HFH2-Z2 is used.

**Step 1:** pre measurement

- Anechoic chamber
- Antenna distance: 3 m
- Antenna height: 1 m
- Detector: Peak-Maxhold
- Frequency range: 0.009 - 0.15 MHz and 0.15 – 30 MHz
- Frequency steps: 0.05 kHz and 2.25 kHz
- IF-Bandwidth: 0.2 kHz and 9 kHz
- Measuring time / Frequency step: 100 ms (FFT-based)

Intention of this step is, to determine the radiated EMI-profile of the EUT. Afterwards the relevant emissions for the final measurement are identified.

**Step 2:** final measurement

For the relevant emissions determined in step 1, an additional measurement with the following settings will be performed. Intention of this step is to find the maximum emission level.

- Detector: Quasi-Peak (9 kHz – 150 kHz, Peak / Average 150 kHz- 30 MHz)
- Frequency range: 0.009 – 30 MHz
- Frequency steps: measurement at frequencies detected in step 1
- IF-Bandwidth: 0.2 - 10 kHz
- Measuring time / Frequency step: 1 s

**2. Measurement above 30 MHz and up to 1 GHz**

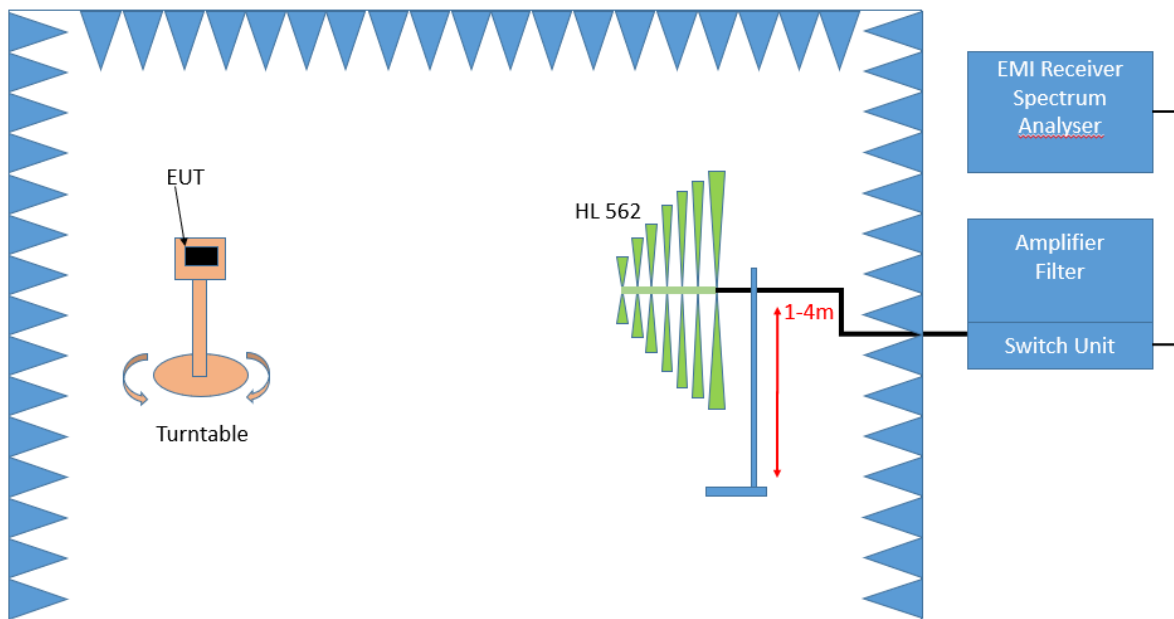

Test Setup; Spurious Emission Radiated (SAC), 30 MHz- 1GHz

### **Step 1:** Preliminary scan

This is a preliminary test to identify the highest amplitudes relative to the limit.

Settings for step 1:

- Antenna distance: 3 m
- Detector: Peak-Maxhold / Quasipeak (FFT-based)
- Frequency range: 30 – 1000 MHz
- Frequency steps: 30 kHz
- IF-Bandwidth: 120 kHz
- Measuring time / Frequency step: 100 ms
- Turntable angle range:  $-180^{\circ}$  to  $90^{\circ}$
- Turntable step size:  $90^{\circ}$
- Height variation range: 1 – 4 m
- Height variation step size: 1.5 m
- Polarisation: Horizontal + Vertical

Intention of this step is, to determine the radiated EMI-profile of the EUT. Afterwards the relevant emissions for the final measurement are identified.

### **Step 2:** Adjustment measurement

In this step the accuracy of the turntable azimuth and antenna height will be improved.

This is necessary to find out the maximum value of every frequency.

For each frequency, which was determined the turntable azimuth and antenna height will be adjusted. The turntable azimuth will slowly vary by  $360^{\circ}$ . During this action, the value of emission is continuously measured. The turntable azimuth at the highest emission will be recorded and adjusted. In this position, the antenna height will also slowly vary between 1 – 4 m. During this action, the value of emission is also continuously measured. The antenna height of the highest emission will also be recorded and adjusted.

- Detector: Peak – Maxhold
- Measured frequencies: in step 1 determined frequencies
- IF – Bandwidth: 120 kHz
- Measuring time: 100 ms
- Turntable angle range:  $360^{\circ}$
- Height variation range: 1 – 4 m
- Antenna Polarisation: max. value determined in step 1

### **Step 3:** Final measurement with QP detector

With the settings determined in step 2, the final measurement will be performed:

EMI receiver settings for step 3:

- Detector: Quasi-Peak (< 1 GHz)
- Measured frequencies: in step 1 determined frequencies
- IF – Bandwidth: 120 kHz
- Measuring time: 1 s

After the measurement a plot will be generated which contains a diagram with the results of the preliminary scan and a chart with the frequencies and values of the results of the final measurement.

### Above 1 GHz:

The Equipment Under Test (EUT) was set up on a non-conductive support (tilt device) at 1.5 m height in the fully-anechoic chamber. All steps were performed with one height (1.5 m) of the receiving antenna only.

### 3. Measurement above 1 GHz

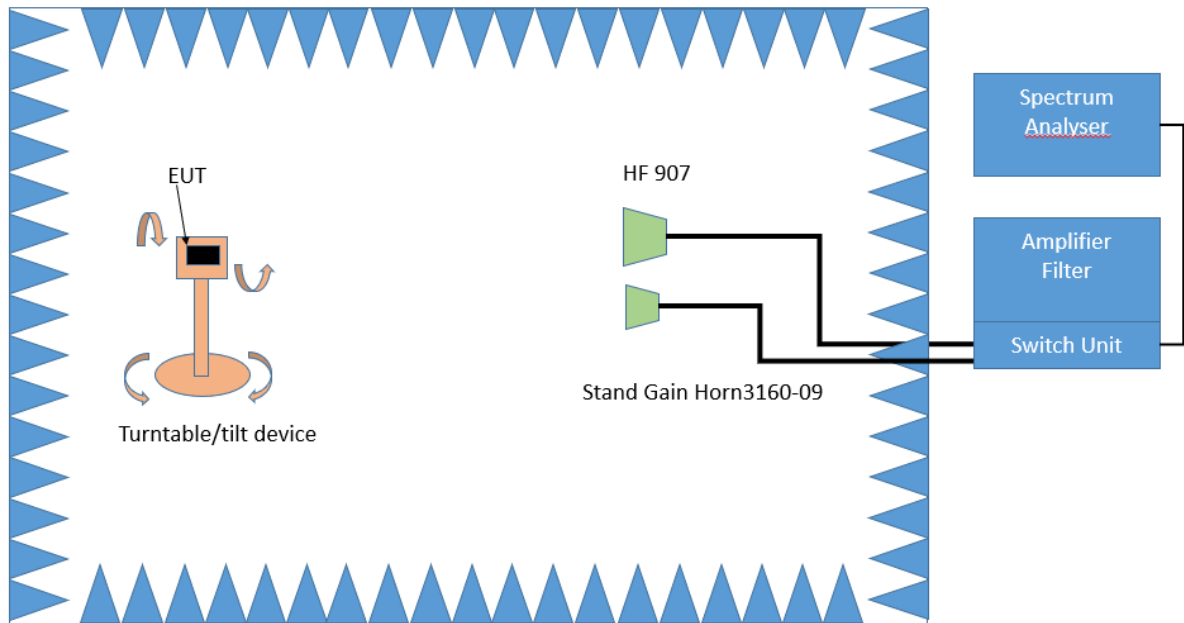

Test Setup; Spurious Emission Radiated (FAC), 1 GHz-26.5 GHz

#### Step 1:

The EUT is turned during the preliminary measurement across the elevation axis, with a step size of 90 °.

The turn table step size (azimuth angle) for the preliminary measurement is 45 °.

Spectrum analyser settings:

- Detector: Peak, Average
- RBW = 1 MHz
- VBW = 3 MHz

#### Step 2:

The turn table azimuth will slowly vary by  $\pm 22.5^\circ$ .

The elevation angle will slowly vary by  $\pm 45^\circ$

Spectrum analyser settings:

- Detector: Peak

#### Step 3:

Spectrum analyser settings for step 3:

- Detector: Peak / CISPR Average
- Measured frequencies: in step 1 determined frequencies
- RBW = 1 MHz
- VBW = 3 MHz
- Measuring time: 1 s

#### 4.2.2. TEST REQUIREMENTS / LIMITS

FCC Part 15, Subpart C, §15.249

(a) Except as provided in paragraph (b) of this section, the field strength of emissions from intentional radiators operated within these frequency bands shall comply with the following:

Fundamental frequency	Field strength of fundamental (millivolts/meter)	Field strength of harmonics (microvolts/meter)
902-928 MHz	50 (94.0 dB $\mu$ V/m)	500 (54.0 dB $\mu$ V/m)
2400-2483.5 MHz	50 (94.0 dB $\mu$ V/m)	500 (54.0 dB $\mu$ V/m)
5725-5875 MHz	50 (94.0 dB $\mu$ V/m)	500 (54.0 dB $\mu$ V/m)
24.0-24.25 GHz	250 (108.0 dB $\mu$ V/m)	2500 (68.0 dB $\mu$ V/m)

Used conversion factor: Limit (dB $\mu$ V/m) = 20 log (Limit ( $\mu$ V/m)/1 $\mu$ V/m)

(c) Field strength limits are specified at a distance of 3 meters.

(d) Emissions radiated outside of the specified frequency bands, except for harmonics, shall be attenuated by at least 50 dB below the level of the fundamental or to the general radiated emission limits in §15.209, whichever is the lesser attenuation.

(e) As shown in §15.35(b), for frequencies above 1000 MHz, the field strength limits in paragraphs (a) and (b) of this section are based on average limits. However, the peak field strength of any emission shall not exceed the maximum permitted average limits specified above by more than 20 dB under any condition of modulation.

FCC Part 15, Subpart C, §15.209, Radiated Emission Limits

Frequency (MHz)	Limit ( $\mu$ V/m)	Measurement distance (m)	Calculate Limit (dB $\mu$ V/m @10m)	Limit (dB $\mu$ V/m) @10m
0.009 – 0.49	2400/F (kHz)	300	(48.5 – 13.8) + 59.1 dB	107.6 – 72.9
0.49 – 1.705	24000/F (kHz)	30	(33.8 – 23.0) + 19.1 dB	52.9 – 42.1
1.705 – 30	30	30	29.5 + 19.1 dB	39.5

Frequency in MHz	Limit ( $\mu$ V/m)	Measurement distance (m)	Limit (dB $\mu$ V/m)
30 – 88	100	3	40.0
88 – 216	150	3	43.5
216 – 960	200	3	46.0
above 960	500	3	54.0

§15.35(b)

..., there is also a limit on the radio frequency emissions, as measured using instrumentation with a peak detector function, corresponding to 20 dB above the maximum permitted average limit....

Used conversion factor: Limit (dB $\mu$ V/m) = 20 log (Limit ( $\mu$ V/m)/1 $\mu$ V/m)

§15.35(b) ..., there is also a limit on the radio frequency emissions, as measured using instrumentation with a peak detector function, corresponding to 20 dB above the maximum permitted average limit ...

Used conversion factor: Limit (dB $\mu$ V/m) = 20 log (Limit ( $\mu$ V/m)/1 $\mu$ V/m)



§15.35(c):

[...] when the radiated emission limits are expressed in terms of the average value of the emission, and pulsed operation is employed, the measurement field strength shall be determined by averaging over one complete pulse train, including blanking intervals, as long as the pulse train does not exceed 0.1 seconds.

As an alternative (provided the transmitter operates for longer than 0.1 seconds) or in cases where the pulse train exceeds 0.1 seconds, the measured field strength shall be determined from the average absolute voltage during a 0.1 second interval during which the field strength is at its maximum value. The exact method of calculating the average field strength shall be submitted [...].

#### 4.2.3. TEST PROTOCOL

##### MEASUREMENT 30 MHz to 1 GHz

Temperature: 23°C  
 Air Pressure: 1011 hPa  
 Humidity: 38 %

Op. Mode	Setup	Port
CW	S01_AA01	Enclosure

High channel:

Frequency (MHz)	QuasiPeak (dBµV/m)	Limit (dBµV/m)	Margin (dB)	Meas. Time (ms)	Bandwidth (kHz)	Height (cm)	Pol	Azimuth (deg)	Corr. (dB/m)
48.000000	22.07	40.00	17.93	1000.0	120.000	133.0	V	-162.0	8.0
72.000000	13.37	40.00	26.63	1000.0	120.000	104.0	V	-34.0	8.7
84.000000	10.03	40.00	29.97	1000.0	120.000	126.0	V	-80.0	10.0
144.000000	17.40	43.50	26.10	1000.0	120.000	128.0	V	-115.0	9.5
156.000000	27.31	43.50	16.19	1000.0	120.000	100.0	V	-116.0	9.3
161.160000	19.28	43.50	24.22	1000.0	120.000	103.0	V	-116.0	9.2
162.870000	17.63	43.50	25.87	1000.0	120.000	122.0	V	-116.0	9.2
168.000000	23.50	43.50	20.00	1000.0	120.000	160.0	H	-102.0	9.3
180.000000	19.57	43.50	23.93	1000.0	120.000	104.0	V	-96.0	10.3
252.000000	21.74	46.00	24.26	1000.0	120.000	119.0	V	-97.0	11.8
264.000000	19.16	46.00	26.84	1000.0	120.000	108.0	H	-176.0	12.2

MEASUREMENT 1 GHz – 26.5 GHz

Temperature: 23°C  
 Air Pressure: 1011 hPa  
 Humidity: 38 %

Op. Mode	Setup	Port
CW	S01_AA01	Enclosure

High channel:

Frequency (MHz)	MaxPeak (dBµV/m)	CAverage (dBµV/m)	Limit (dBµV/m)	Margin (dB)	Meas. Time (ms)	Bandwidth (kHz)	Height (cm)	Pol	Azimuth (deg)	Elevation (deg)	Corr. (dB/m)
1746.807	46.2	---	73.98	27.79	1000.0	1000.000	150.0	V	-41.0	14.0	1.9
1746.926	---	31.3	53.98	22.71	1000.0	1000.000	150.0	V	-36.0	-22.0	1.9
2483.913	49.8	---	73.98	24.20	1000.0	1000.000	150.0	V	101.0	110.0	5.3
2483.913	---	34.7	53.98	19.24	1000.0	1000.000	150.0	H	-79.0	-22.0	5.3
4960.363	---	46.3	53.98	7.73	1000.0	1000.000	150.0	H	-55.0	-17.0	4.4
4960.363	53.7	---	73.98	20.25	1000.0	1000.000	150.0	H	-52.0	-8.0	4.4
7440.250	---	53.9	53.98	0.05	1000.0	1000.000	150.0	H	-43.0	-8.0	-13.2
7440.250	57.4	---	73.98	16.56	1000.0	1000.000	150.0	H	-42.0	-12.0	-13.2
9920.613	58.6	---	73.98	15.34	1000.0	1000.000	150.0	H	-90.0	-8.0	-11.1
9920.613	---	50.6	53.98	3.35	1000.0	1000.000	150.0	H	-92.0	-8.0	-11.1

4.2.4. MEASUREMENT PLOTS

Radio Technology = BTLE, Operating Frequency = High, Frequency Range 30 MHz – 1 GHz (S01\_AA01)

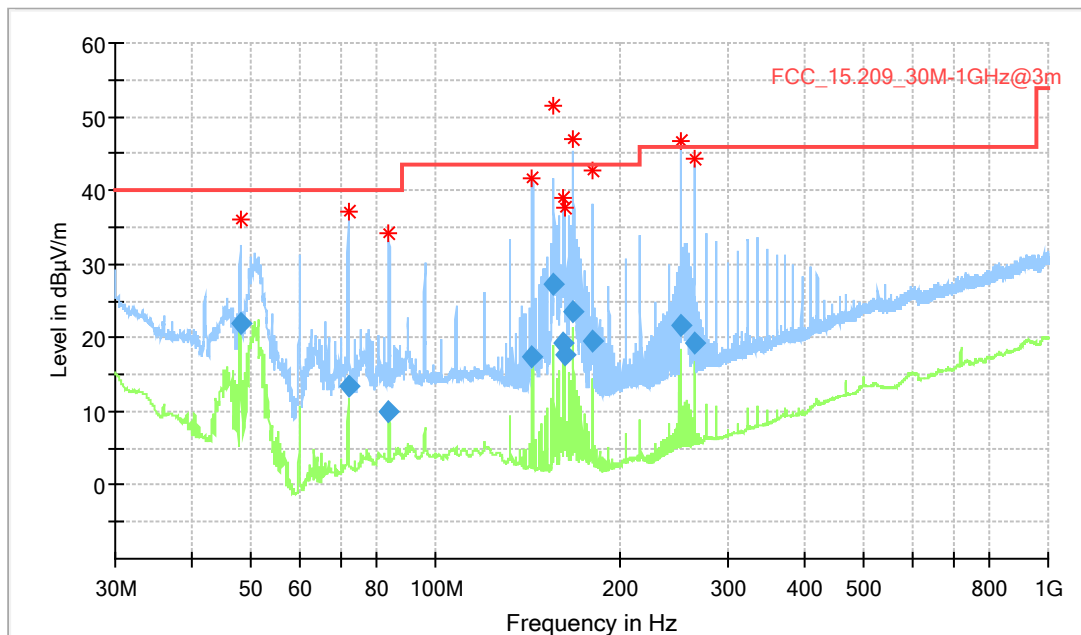

Radio Technology = BTLE, Operating Frequency = High, Frequency Range 1 – 26.0 GHz (S01\_AA01)

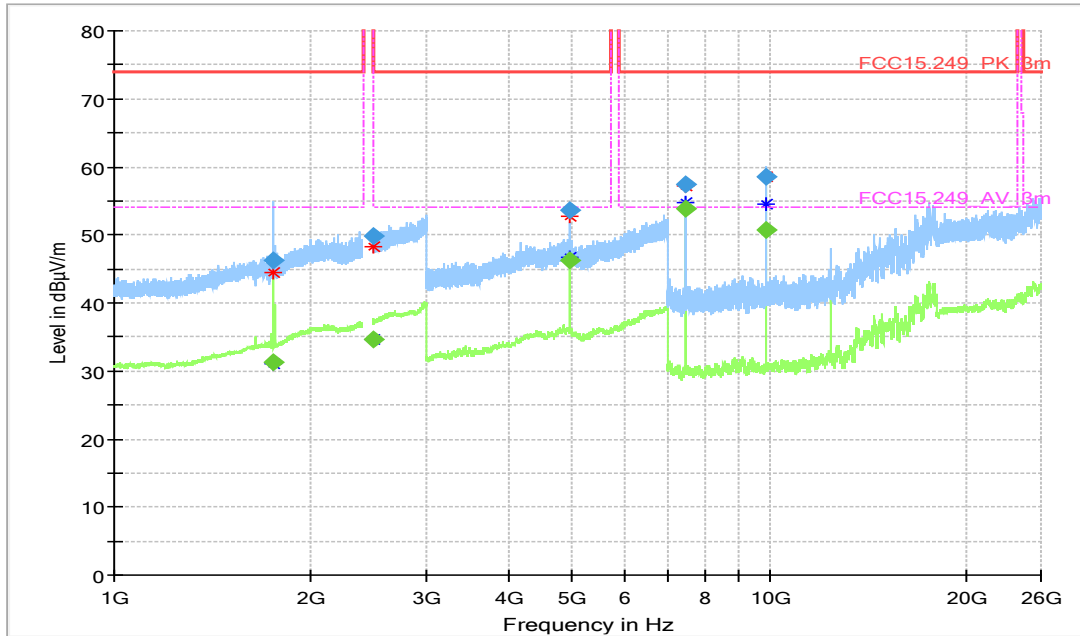

#### 4.2.5. TEST EQUIPMENT USED

- Radiated Emissions

## 5. TEST EQUIPMENT

### 1 Radiated Emissions FAR Radiated Emissions in a fully anechoic room

Ref.No.	Device Name	Description	Manufacturer	Serial Number	Last Calibration	Calibration Due
1.1	Opus10 TPR (8253.00)	T/P Logger 13	Lufft Mess- und Regeltechnik GmbH	13936	2021-10	2023-10
1.2	AMF-7D00101800-30-10P-R	Broadband Amplifier 100 MHz - 18 GHz	Miteq			
1.3	5HC2700/12750-1.5-KK	High Pass Filter	Trilithic	9942012		
1.4	ASP 1.2/1.8-10 kg	Antenna Mast	Maturo GmbH	-		
1.5	Anechoic Chamber 03	FAR, 8.80m x 4.60m x 4.05m (l x w x h)	Albatross Projects	P26971-647-001-PRB	2021-04	2023-04
1.6	Fluke 177	Digital Multimeter 03 (Multimeter)	Fluke Europe B.V.	86670383	2020-04	2022-04
1.7	JS4-18002600-32-5P	Broadband Amplifier 18 GHz - 26 GHz	Miteq	849785		
1.8	FSW 43	Spectrum Analyzer	Rohde & Schwarz	103779	2021-06	2023-06
1.9	3160-09	Standard Gain / Pyramidal Horn Antenna 26.5 GHz	EMCO Elektronik GmbH	00083069		
1.10	WHKX 7.0/18G-8SS	High Pass Filter	Wainwright Instruments GmbH	09		
1.11	4HC1600/12750-1.5-KK	High Pass Filter	Trilithic	9942011		
1.12	TT 1.5 WI	Turn Table	Maturo GmbH	-		
1.13	3160-10	Standard Gain / Pyramidal Horn Antenna 40 GHz	EMCO Elektronik GmbH	00086675		
1.14	5HC3500/18000-1.2-KK	High Pass Filter	Trilithic	200035008		
1.15	TD1.5-10kg	EUT Tilt Device (Rohacell)	Maturo GmbH	TD1.5-10kg/024/3790709		
1.16	PAS 2.5 - 10 kg	Antenna Mast	Maturo GmbH	-		
1.17	AFS42-00101800-25-S-42	Broadband Amplifier 25 MHz - 18 GHz	Miteq	2035324		
1.18	HF 907	Double-ridged horn	Rohde & Schwarz	102444	2021-09	2024-09

2 Radiated Emissions SAC up to 1 GHz  
Radiated emission tests up to 1 GHz in a semi anechoic room

Ref.No.	Device Name	Description	Manufacturer	Serial Number	Last Calibration	Calibration Due
2.1	Opus10 TPR (8253.00)	T/P Logger 13	Lufft Mess- und Regeltechnik GmbH	13936	2021-10	2023-10
2.2	ESW44	EMI Receiver / Spectrum Analyzer	Rohde & Schwarz GmbH & Co. KG	101603	2019-12	2021-12
2.3	Anechoic Chamber 01	SAC/FAR, 10.58 m x 6.38 m x 6.00 m	Frankonia	none		
2.4	HL 562 ULTRALOG	Biconical-log- per antenna (30 MHz - 3 GHz) with HL 562E biconicals	Rohde & Schwarz GmbH & Co. KG	830547/003	2021-09	2024-09
2.5	Opus10 THI (8152.00)	T/H Logger 10	Lufft Mess- und Regeltechnik GmbH	12488	2021-08	2023-08
2.6	DS 420S	Turn Table 2 m diameter	HD GmbH	420/573/99		
2.7	AM 4.0	Antenna Mast 4 m	Maturo GmbH	AM4.0/180/1192 0513		

The calibration interval is the time interval between “Last Calibration” and “Calibration Due”

## 6. ANTENNA FACTORS, CABLE LOSS AND SAMPLE CALCULATIONS

This chapter contains the antenna factors with their corresponding path loss of the used measurement path for all antennas as well as the insertion loss of the LISN.

### 6.1. LISN R&S ESH3-Z5 (150 KHZ – 30 MHZ)

Frequency MHz	Corr. dB	LISN insertion loss ESH3- Z5 dB	cable loss (incl. 10 dB atten- uator) dB
0.15	10.1	0.1	10.0
5	10.3	0.1	10.2
7	10.5	0.2	10.3
10	10.5	0.2	10.3
12	10.7	0.3	10.4
14	10.7	0.3	10.4
16	10.8	0.4	10.4
18	10.9	0.4	10.5
20	10.9	0.4	10.5
22	11.1	0.5	10.6
24	11.1	0.5	10.6
26	11.2	0.5	10.7
28	11.2	0.5	10.7
30	11.3	0.5	10.8

#### Sample calculation

$$U_{LISN} \text{ (dB } \mu\text{V)} = U \text{ (dB } \mu\text{V)} + \text{Corr. (dB)}$$

U = Receiver reading

LISN Insertion loss = Voltage Division Factor of LISN

Corr. = sum of single correction factors of used LISN, cables, switch units (if used)

Linear interpolation will be used for frequencies in between the values in the table.



### 6.3. ANTENNA R&S HL562 (30 MHZ – 1 GHZ)

( $d_{Limit} = 3\text{ m}$ )

Frequency MHz	AF R&S HL562 dB (1/m)	Corr. dB	cable loss 1 (inside chamber) dB	cable loss 2 (outside chamber) dB	cable loss 3 (switch unit) dB	cable loss 4 (to receiver) dB	distance corr. (-20 dB/ decade) dB	$d_{Limit}$ (meas. distance (limit)) m	$d_{used}$ (meas. distance (used)) m
30	18.6	0.6	0.29	0.04	0.23	0.02	0.0	3	3
50	6.0	0.9	0.39	0.09	0.32	0.08	0.0	3	3
100	9.7	1.2	0.56	0.14	0.47	0.08	0.0	3	3
150	7.9	1.6	0.73	0.20	0.59	0.12	0.0	3	3
200	7.6	1.9	0.84	0.21	0.70	0.11	0.0	3	3
250	9.5	2.1	0.98	0.24	0.80	0.13	0.0	3	3
300	11.0	2.3	1.04	0.26	0.89	0.15	0.0	3	3
350	12.4	2.6	1.18	0.31	0.96	0.13	0.0	3	3
400	13.6	2.9	1.28	0.35	1.03	0.19	0.0	3	3
450	14.7	3.1	1.39	0.38	1.11	0.22	0.0	3	3
500	15.6	3.2	1.44	0.39	1.20	0.19	0.0	3	3
550	16.3	3.5	1.55	0.46	1.24	0.23	0.0	3	3
600	17.2	3.5	1.59	0.43	1.29	0.23	0.0	3	3
650	18.1	3.6	1.67	0.34	1.35	0.22	0.0	3	3
700	18.5	3.6	1.67	0.42	1.41	0.15	0.0	3	3
750	19.1	4.1	1.87	0.54	1.46	0.25	0.0	3	3
800	19.6	4.1	1.90	0.46	1.51	0.25	0.0	3	3
850	20.1	4.4	1.99	0.60	1.56	0.27	0.0	3	3
900	20.8	4.7	2.14	0.60	1.63	0.29	0.0	3	3
950	21.1	4.8	2.22	0.60	1.66	0.33	0.0	3	3
1000	21.6	4.9	2.23	0.61	1.71	0.30	0.0	3	3

( $d_{Limit} = 10\text{ m}$ )

30	18.6	-9.9	0.29	0.04	0.23	0.02	-10.5	10	3
50	6.0	-9.6	0.39	0.09	0.32	0.08	-10.5	10	3
100	9.7	-9.2	0.56	0.14	0.47	0.08	-10.5	10	3
150	7.9	-8.8	0.73	0.20	0.59	0.12	-10.5	10	3
200	7.6	-8.6	0.84	0.21	0.70	0.11	-10.5	10	3
250	9.5	-8.3	0.98	0.24	0.80	0.13	-10.5	10	3
300	11.0	-8.1	1.04	0.26	0.89	0.15	-10.5	10	3
350	12.4	-7.9	1.18	0.31	0.96	0.13	-10.5	10	3
400	13.6	-7.6	1.28	0.35	1.03	0.19	-10.5	10	3
450	14.7	-7.4	1.39	0.38	1.11	0.22	-10.5	10	3
500	15.6	-7.2	1.44	0.39	1.20	0.19	-10.5	10	3
550	16.3	-7.0	1.55	0.46	1.24	0.23	-10.5	10	3
600	17.2	-6.9	1.59	0.43	1.29	0.23	-10.5	10	3
650	18.1	-6.9	1.67	0.34	1.35	0.22	-10.5	10	3
700	18.5	-6.8	1.67	0.42	1.41	0.15	-10.5	10	3
750	19.1	-6.3	1.87	0.54	1.46	0.25	-10.5	10	3
800	19.6	-6.3	1.90	0.46	1.51	0.25	-10.5	10	3
850	20.1	-6.0	1.99	0.60	1.56	0.27	-10.5	10	3
900	20.8	-5.8	2.14	0.60	1.63	0.29	-10.5	10	3
950	21.1	-5.6	2.22	0.60	1.66	0.33	-10.5	10	3
1000	21.6	-5.6	2.23	0.61	1.71	0.30	-10.5	10	3

#### Sample calculation

$$E \text{ (dB } \mu\text{V/m)} = U \text{ (dB } \mu\text{V)} + \text{AF (dB 1/m)} + \text{Corr. (dB)}$$

U = Receiver reading

AF = Antenna factor

Corr. = sum of single correction factors of used cables, switch unit, distance correction, amplifier (if applicable)

distance correction =  $-20 * \text{LOG} (d_{Limit} / d_{used})$

Linear interpolation will be used for frequencies in between the values in the table.

Tables show an extract of values.



#### 6.4. ANTENNA R&S HF907 (1 GHZ – 18 GHZ)

Frequency	AF R&S HF907	Corr.
MHz	dB (1/m)	dB
1000	24.4	-19.4
2000	28.5	-17.4
3000	31.0	-16.1
4000	33.1	-14.7
5000	34.4	-13.7
6000	34.7	-12.7
7000	35.6	-11.0

cable loss 1 (relay + cable inside chamber)	cable loss 2 (outside chamber)	cable loss 3 (switch unit, attenuator & pre-amp)	cable loss 4 (to receiver)		
dB	dB	dB	dB		
0.99	0.31	-21.51	0.79		
1.44	0.44	-20.63	1.38		
1.87	0.53	-19.85	1.33		
2.41	0.67	-19.13	1.31		
2.78	0.86	-18.71	1.40		
2.74	0.90	-17.83	1.47		
2.82	0.86	-16.19	1.46		

Frequency	AF R&S HF907	Corr.
MHz	dB (1/m)	dB
3000	31.0	-23.4
4000	33.1	-23.3
5000	34.4	-21.7
6000	34.7	-21.2
7000	35.6	-19.8

cable loss 1 (relay inside chamber)	cable loss 2 (inside chamber)	cable loss 3 (outside chamber)	cable loss 4 (switch unit, attenuator & pre-amp)	cable loss 5 (to receiver)	used for FCC 15.247
dB	dB	dB	dB	dB	
0.47	1.87	0.53	-27.58	1.33	
0.56	2.41	0.67	-28.23	1.31	
0.61	2.78	0.86	-27.35	1.40	
0.58	2.74	0.90	-26.89	1.47	
0.66	2.82	0.86	-25.58	1.46	

Frequency	AF R&S HF907	Corr.
MHz	dB (1/m)	dB
7000	35.6	-57.3
8000	36.3	-56.3
9000	37.1	-55.3
10000	37.5	-56.2
11000	37.5	-55.3
12000	37.6	-53.7
13000	38.2	-53.5
14000	39.9	-56.3
15000	40.9	-54.1
16000	41.3	-54.1
17000	42.8	-54.4
18000	44.2	-54.7

cable loss 1 (relay inside chamber)	cable loss 2 (High Pass)	cable loss 3 (pre-amp)	cable loss 4 (inside chamber)	cable loss 5 (outside chamber)	cable loss 6 (to receiver)
dB	dB	dB	dB	dB	dB
0.56	1.28	-62.72	2.66	0.94	1.46
0.69	0.71	-61.49	2.84	1.00	1.53
0.68	0.65	-60.80	3.06	1.09	1.60
0.70	0.54	-61.91	3.28	1.20	1.67
0.80	0.61	-61.40	3.43	1.27	1.70
0.84	0.42	-59.70	3.53	1.26	1.73
0.83	0.44	-59.81	3.75	1.32	1.83
0.91	0.53	-63.03	3.91	1.40	1.77
0.98	0.54	-61.05	4.02	1.44	1.83
1.23	0.49	-61.51	4.17	1.51	1.85
1.36	0.76	-62.36	4.34	1.53	2.00
1.70	0.53	-62.88	4.41	1.55	1.91

#### Sample calculation

$$E \text{ (dB } \mu\text{V/m)} = U \text{ (dB } \mu\text{V)} + \text{AF (dB 1/m)} + \text{Corr. (dB)}$$

U = Receiver reading

AF = Antenna factor

Corr. = sum of single correction factors of used cables, switch unit, distance correction, amplifier (if applicable)

Linear interpolation will be used for frequencies in between the values in the table.

Tables show an extract of values.

6.5. ANTENNA EMCO 3160-09 (18 GHZ – 26.5 GHZ)

Frequency MHz	AF EMCO 3160-09 dB (1/m)	Corr. dB	cable loss 1 (inside chamber) dB	cable loss 2 (pre- amp) dB	cable loss 3 (inside chamber) dB	cable loss 4 (switch unit) dB	cable loss 5 (to receiver) dB
18000	40.2	-23.5	0.72	-35.85	6.20	2.81	2.65
18500	40.2	-23.2	0.69	-35.71	6.46	2.76	2.59
19000	40.2	-22.0	0.76	-35.44	6.69	3.15	2.79
19500	40.3	-21.3	0.74	-35.07	7.04	3.11	2.91
20000	40.3	-20.3	0.72	-34.49	7.30	3.07	3.05
20500	40.3	-19.9	0.78	-34.46	7.48	3.12	3.15
21000	40.3	-19.1	0.87	-34.07	7.61	3.20	3.33
21500	40.3	-19.1	0.90	-33.96	7.47	3.28	3.19
22000	40.3	-18.7	0.89	-33.57	7.34	3.35	3.28
22500	40.4	-19.0	0.87	-33.66	7.06	3.75	2.94
23000	40.4	-19.5	0.88	-33.75	6.92	3.77	2.70
23500	40.4	-19.3	0.90	-33.35	6.99	3.52	2.66
24000	40.4	-19.8	0.88	-33.99	6.88	3.88	2.58
24500	40.4	-19.5	0.91	-33.89	7.01	3.93	2.51
25000	40.4	-19.3	0.88	-33.00	6.72	3.96	2.14
25500	40.5	-20.4	0.89	-34.07	6.90	3.66	2.22
26000	40.5	-21.3	0.86	-35.11	7.02	3.69	2.28
26500	40.5	-21.1	0.90	-35.20	7.15	3.91	2.36

**Sample calculation**

$E \text{ (dB } \mu\text{V/m)} = U \text{ (dB } \mu\text{V)} + AF \text{ (dB 1/m)} + Corr. \text{ (dB)}$   
 U = Receiver reading  
 AF = Antenna factor  
 Corr. = sum of single correction factors of used cables, switch unit, distance correction, amplifier (if applicable)  
 Linear interpolation will be used for frequencies in between the values in the table.  
 Table shows an extract of values.

6.6. ANTENNA EMCO 3160-10 (26.5 GHZ – 40 GHZ)

Frequency GHz	AF EMCO 3160-10 dB (1/m)	Corr. dB	cable loss 1 (inside chamber) dB	cable loss 2 (outside chamber) dB	cable loss 3 (switch unit) dB	cable loss 4 (to receiver) dB	distance corr. (-20 dB/ decade) dB	d <sub>Limit</sub> (meas. distance (limit) m	d <sub>used</sub> (meas. distance (used) m
26.5	43.4	-11.2	4.4				-9.5	3	1.0
27.0	43.4	-11.2	4.4				-9.5	3	1.0
28.0	43.4	-11.1	4.5				-9.5	3	1.0
29.0	43.5	-11.0	4.6				-9.5	3	1.0
30.0	43.5	-10.9	4.7				-9.5	3	1.0
31.0	43.5	-10.8	4.7				-9.5	3	1.0
32.0	43.5	-10.7	4.8				-9.5	3	1.0
33.0	43.6	-10.7	4.9				-9.5	3	1.0
34.0	43.6	-10.6	5.0				-9.5	3	1.0
35.0	43.6	-10.5	5.1				-9.5	3	1.0
36.0	43.6	-10.4	5.1				-9.5	3	1.0
37.0	43.7	-10.3	5.2				-9.5	3	1.0
38.0	43.7	-10.2	5.3				-9.5	3	1.0
39.0	43.7	-10.2	5.4				-9.5	3	1.0
40.0	43.8	-10.1	5.5				-9.5	3	1.0

Sample calculation

$E \text{ (dB } \mu\text{V/m)} = U \text{ (dB } \mu\text{V)} + AF \text{ (dB 1/m)} + Corr. \text{ (dB)}$   
 U = Receiver reading  
 AF = Antenna factor  
 Corr. = sum of single correction factors of used cables, switch unit, distance correction, amplifier (if applicable)  
 Linear interpolation will be used for frequencies in between the values in the table.  
 distance correction =  $-20 * \text{LOG} (d_{\text{Limit}} / d_{\text{used}})$   
 Linear interpolation will be used for frequencies in between the values in the table.  
 Table shows an extract of values.

7. PHOTO REPORT

Please see separate photo report.

## 8. MEASUREMENT UNCERTAINTIES

### Measurement Uncertainties

Parameter	Uncertainty
Antenna Power, Antenna Power Tolerance	$\pm 1.2$ dB
Frequency Tolerance	$\pm 5.0$ Hz
Transmitter Spurious Emissions, Limit on secondary radiated emissions	$\pm 2.5$ dB
Occupied bandwidth, Spread Bandwidth	$\pm 825$ kHz
Dwell time	$\pm 30.0$ $\mu$ s
Temperature	$\pm 0.3$ $^{\circ}$ C
Humidity	$\pm 3\%$
DC and low frequency voltages	$\pm 1.5\%$ + 2 digits
Time	$\pm 5\%$
Antenna Gain and Pattern	$\pm 1.8$ dB

The measurement uncertainties for all parameters are calculated with an expansion factor (coverage factor)  $k = 1.96$ . This means, that the true value is in the corresponding interval with a probability of 95 %.

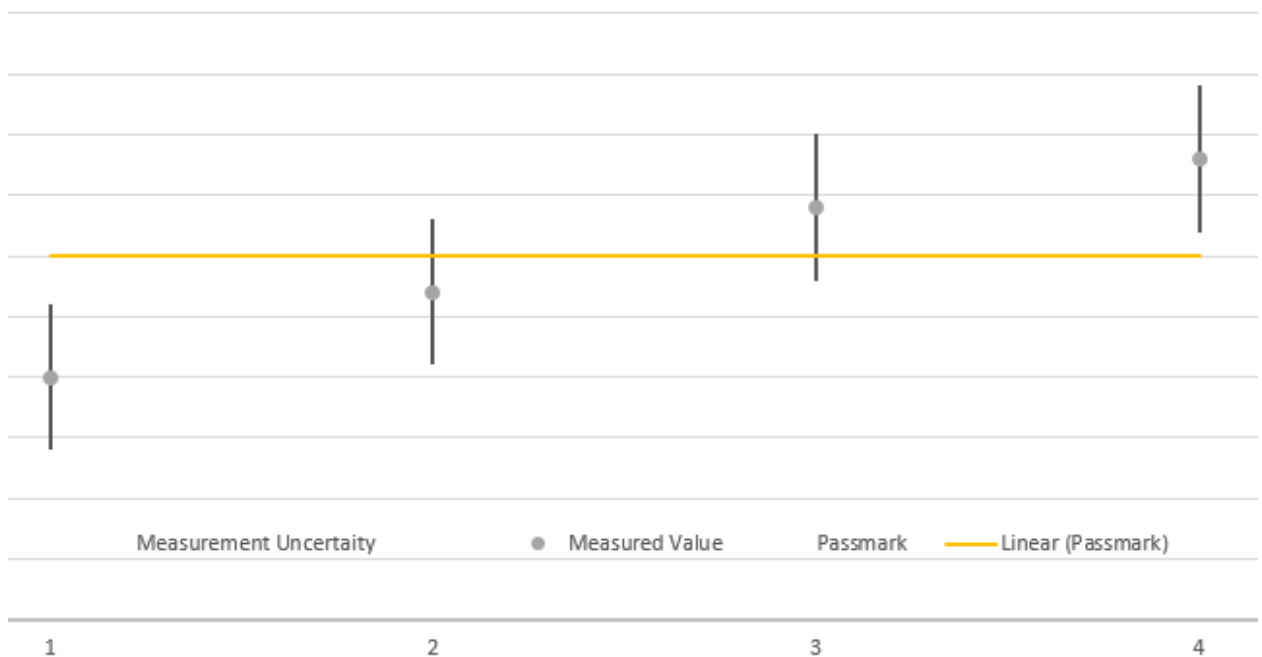

The verdicts in this test report are given according the above diagram:

Case	Measured Value	Uncertainty Range	Verdict
1	below pass mark	below pass mark	Passed
2	below pass mark	within pass mark	Passed
3	above pass mark	within pass mark	Failed
4	above pass mark	above pass mark	Failed

That means, the laboratory applies, as decision rule (see ISO/IEC 17025:2017), the so called shared risk principle.