

RADIO TEST REPORT – 463765-1TRFWL

Type of assessment:

Final product testing

Applicant:

Electronics4All Inc.

Product:

4-20mA Current Loop Sensor

Model (HVIN):

CLS-4-420-TH

FCC ID:

2AXVKCLS01

ISED Certification number:

IC: 26661-CLS01

Specifications:

- ◆ FCC 47 CFR Part 15 Subpart C, §15.247
- ◆ RSS-247, Issue 2, Feb 2017, Section 5

Date of issue: **July 28, 2022**

Avul Nzenza, EMC/RF Specialist

Tested by



Signature

Predrag Golic, Senior EMC/RF Specialist

Tested by



Signature

David Duchesne, EMC/RF Lab Manager

Reviewed by



Signature

Nemko Canada Inc., a testing laboratory, is accredited by the Standards Council of Canada.
The tests included in this report are within the scope of this accreditation.
The SCC Accreditation Symbol is an official symbol of the Standards Council of Canada, used under licence.

SCC File Number: 15064 (Ottawa/Almonte); 151100 (Montreal); 151097 (Cambridge)





Lab locations

Company name	Nemko Canada Inc.			
Facilities	<i>Ottawa site:</i> 303 River Road Ottawa, Ontario Canada K1V 1H2 Tel: +1 613 737 9680 Fax: +1 613 737 9691	<i>Montréal site:</i> 292 Labrosse Avenue Pointe-Claire, Québec Canada H9R 5L8 Tel: +1 514 694 2684 Fax: +1 514 694 3528	<i>Cambridge site:</i> 1-130 Saltsman Drive Cambridge, Ontario Canada N3E 0B2 Tel: +1 519 650 4811	<i>Almonte site:</i> 1500 Peter Robinson Road West Carleton, Ontario Canada K0A 1L0 Tel: +1 613 256-9117
	Test site registration	Organization FCC/ISED	Recognition numbers and location FCC: CA2040; IC: 2040A-4 (Ottawa/Almonte); FCC: CA2041; IC: 2040G-5 (Montreal); CA0101 (Cambridge)	
Website	www.nemko.com			

Limits of responsibility

Note that the results contained in this report relate only to the items tested and were obtained in the period between the date of initial receipt of samples and the date of issue of the report.

This test report has been completed in accordance with the requirements of ISO/IEC 17025. All results contained in this report are within Nemko Canada's ISO/IEC 17025 accreditation.

Copyright notification

Nemko Canada Inc. authorizes the applicant to reproduce this report provided it is reproduced in its entirety and for use by the company's employees only. Any use which a third party makes of this report, or any reliance on or decisions to be made based on it, are the responsibility of such third parties.

Nemko Canada Inc. accepts no responsibility for damages, if any, suffered by any third party as a result of decisions made or actions based on this report.

© Nemko Canada Inc.



Table of Contents

Table of Contents	3
Section 1 Report summary	4
1.1 Test specifications	4
1.2 Test methods	4
1.3 Exclusions	4
1.4 Statement of compliance	4
1.5 Test report revision history	4
Section 2 Engineering considerations	5
2.1 Modifications incorporated in the EUT for compliance	5
2.2 Technical judgment	5
2.3 Deviations from laboratory tests procedures	5
Section 3 Test conditions	6
3.1 Atmospheric conditions	6
3.2 Power supply range	6
Section 4 Measurement uncertainty	7
4.1 Uncertainty of measurement	7
Section 5 Information provided by the applicant	8
5.1 Disclaimer	8
5.2 Applicant/Manufacture	8
5.3 EUT information	8
5.4 Radio technical information	8
5.5 EUT setup details	9
Section 6 Summary of test results	10
6.1 Testing location	10
6.2 Testing period	10
6.3 Sample information	10
6.4 FCC Part 15 Subpart A and C, general requirements test results	10
6.5 FCC Part §15.247 test results for digital transmission systems (DTS)	10
6.6 ISED RSS-Gen, Issue 5, test results	11
6.7 ISED RSS-247, Issue 2, test results for digital transmission systems (DTS)	11
Section 7 Test equipment	12
7.1 Test equipment list	12
Section 8 Testing data	13
8.1 Variation of power source	13
8.2 Number of frequencies	14
8.3 Antenna requirement	16
8.4 AC power line conducted emissions limits	17
8.5 Minimum 6 dB bandwidth for DTS systems	20
8.6 Transmitter output power and e.i.r.p. requirements for DTS in 2.4 GHz	23
8.7 Spurious (out-of-band) unwanted emissions	26
8.8 Power spectral density for digitally modulated devices	37
Section 9 EUT photos	39
9.1 External photos	39

Section 1 Report summary

1.1 Test specifications

FCC 47 CFR Part 15, Subpart C, Clause 15.247	Operation in the 902–928 MHz, 2400–2483.5 MHz, and 5725–585 MHz
RSS-247, Issue 2, Feb 2017, Section 5	Digital Transmission Systems (DTSs), Frequency Hopping Systems (FHSs) and Licence-Exempt Local Area Network (LE-LAN) Devices

1.2 Test methods

558074 D01 15.247 Meas Guidance v05r02 (April 2, 2019)	Guidance for compliance measurements on digital transmission system, frequency hopping spread spectrum system, and hybrid system devices operating under section 15.247 of the FCC rules.
ANSI C63.10 v2013	American National Standard of Procedures for Compliance Testing of Unlicensed Wireless Devices
RSS-102, Issue 5, March 19, 2015	Radio Frequency (RF) Exposure Compliance of Radiocommunication Apparatus (All Frequency Bands)

1.3 Exclusions

None

1.4 Statement of compliance

In the configuration tested, the EUT was found compliant.

Testing was performed against all relevant requirements of the test standard except as noted in section 1.3 above. Results obtained indicate that the product under test complies in full with the requirements tested. The test results relate only to the items tested.

See “Summary of test results” for full details.

1.5 Test report revision history

Table 1.5-1: Test report revision history

Revision #	Date of issue	Details of changes made to test report
TRF	July 28, 2022	Original report issued

Section 2 Engineering considerations

2.1 Modifications incorporated in the EUT for compliance

There were no modifications performed to the EUT during this assessment.

2.2 Technical judgment

Antenna port conducted measurements utilized from FCC ID: 2AXVKBMS01, IC: 26661-BMS01. The RF portion was not changed.

2.3 Deviations from laboratory tests procedures

No deviations were made from laboratory procedures.

Section 3 Test conditions

3.1 Atmospheric conditions

Temperature	15 °C – 35 °C
Relative humidity	20 % – 75 %
Air pressure	86 kPa (860 mbar) – 106 kPa (1060 mbar)

When it is impracticable to carry out tests under these conditions, a note to this effect stating the ambient temperature and relative humidity during the tests shall be recorded and stated.

3.2 Power supply range

The normal test voltage for equipment to be connected to the mains shall be the nominal mains voltage. For the purpose of the present document, the nominal voltage shall be the declared voltage, or any of the declared voltages $\pm 5\%$, for which the equipment was designed.

Section 4 Measurement uncertainty

4.1 Uncertainty of measurement

UKAS Lab 34 and TIA-603-B have been used as guidance for measurement uncertainty reasonable estimations with regards to previous experience and validation of data. Nemko Canada, Inc. follows these test methods in order to satisfy ISO/IEC 17025 requirements for estimation of uncertainty of measurement for wireless products.

Measurement uncertainty budgets for the tests are detailed below. Measurement uncertainty calculations assume a coverage factor of $K = 2$ with 95% certainty.

Table 4.1-1: Measurement uncertainty calculations

Test name	Measurement uncertainty, \pm dB
All antenna port measurements	0.55
Occupied bandwidth	4.45
Conducted spurious emissions	1.13
Radiated spurious emissions	3.78
AC power line conducted emissions	3.55

Section 5 Information provided by the applicant

5.1 Disclaimer

This section contains information provided by the applicant and has been utilized to support the test plan. Inaccurate information provided by the applicant can affect the validity of the results contained within this test report. Nemko accepts no responsibility for the information contained within this section and the impact it may have on the test plan and resulting measurements.

5.2 Applicant/Manufacture

Applicant name	Electronics4All Inc.
Applicant address	110 Didsbury Road Unit 50, Kanata, ON Canada, K2T 0C2
Manufacturer name	Same as applicant
Manufacturer address	Same as applicant

5.3 EUT information

Product	4-20mA Current Loop Sensor
Model	CLS-4-420-TH
Serial number	F88A5E53 [original]; CLS-001-000001 [additional testing]
Power supply requirements	Operational mode: Battery: 3 – 4.2 V _{DC} Charging mode: 12 V _{DC} (via external 100–240 V _{AC} , 50/60 Hz power adapter)
Product description and theory of operation	Measures current and wirelessly sends data to Gateway

5.4 Radio technical information

Category of Wideband Data Transmission equipment	Other types of Wideband Data Transmission equipment (e.g. DSSS, OFDM, etc.).
Frequency band	2400–2483.5 MHz
Frequency Min (MHz)	2402
Frequency Max (MHz)	2480
Channel numbers	40
RF power Max (W), Conducted	0.00291 (4.64 dBm)
Field strength, dB μ V/m @ 3 m	N/A
Measured BW (kHz), 99% OBW	1089
Type of modulation	BLE (GFSK)
Emission classification	1M09F1D
Transmitter spurious, dB μ V/m @ 3 m	37.06 (Average) at 2483.5 MHz
Antenna information	PulseLarsen Antennas W1010, +2 dBi Gain

5.5 EUT setup details

5.5.1 EUT Setup details

EUT setup to continues transmit state with 100% duty cycle

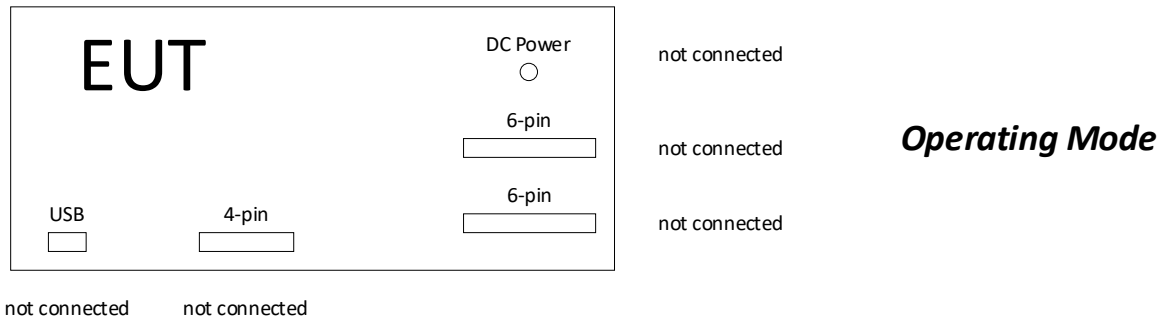
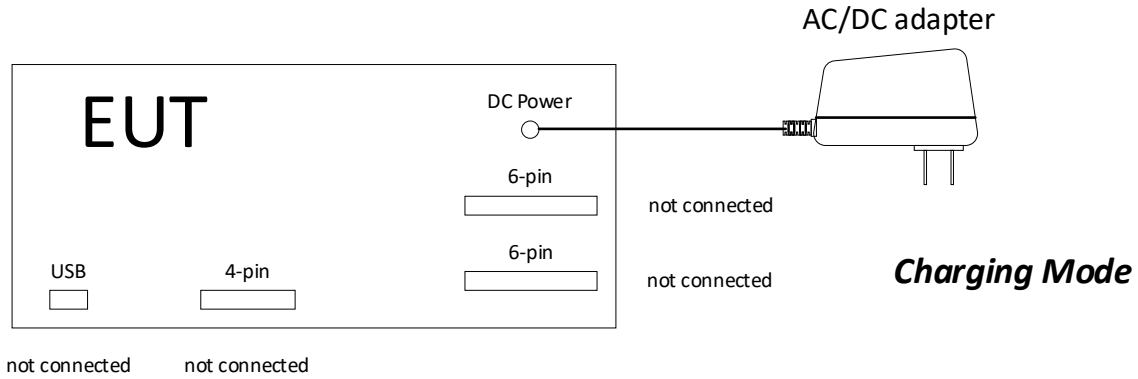

Figure 5.5-1: Test setup block diagram

Section 6 Summary of test results

6.1 Testing location

Test location (s)	Ottawa
-------------------	--------

6.2 Testing period

Initial testing

Test start date	October 7, 2020	Test end date	October 12, 2020
-----------------	-----------------	---------------	------------------

Additional testing

Test start date	April 6, 2022	Test end date	April 8, 2022
-----------------	---------------	---------------	---------------

6.3 Sample information

Initial testing

Receipt date	October 7, 2020	Nemko sample ID number(s)	1 & 2
--------------	-----------------	---------------------------	-------

Additional testing

Receipt date	April 5, 2022	Nemko sample ID number	46376500001
--------------	---------------	------------------------	-------------

6.4 FCC Part 15 Subpart A and C, general requirements test results

Table 6.4-1: FCC general requirements results

Part	Test description	Verdict
§15.207(a)	Conducted limits	Pass
§15.31l	Variation of power source	Pass
§15.31(m)	Number of tested frequencies	Pass
§15.203	Antenna requirement	Pass

Notes: EUT is an AC powered device.

6.5 FCC Part §15.247 test results for digital transmission systems (DTS)

Table 6.5-1: FCC DTS requirements results

Part	Test description	Verdict
§15.247(a)(2)	Minimum 6 dB bandwidth	Pass
§15.247(b)(3)	Maximum peak output power in the 902–928 MHz, 2400–2483.5 MHz, and 5725–5850 MHz bands	Pass
§15.247(1)	Fixed point-to-point operation with directional antenna gains greater than 6 dBi	Not applicable
§15.247(2)	Transmitters operating in the 2400–2483.5 MHz band that emit multiple directional beams	Not applicable
§15.247(d)	Spurious emissions	Pass
§15.247l	Power spectral density	Pass
§15.247(f)	Time of occupancy for hybrid systems	Not applicable

6.6 ISED RSS-Gen, Issue 5, test results

Table 6.6-1: RSS-Gen requirements results

Part	Test description	Verdict
7.3	Receiver radiated emission limits	Not applicable
7.4	Receiver conducted emission limits	Not applicable
6.9	Operating bands and selection of test frequencies	Pass
8.8	AC power-line conducted emissions limits	Pass

Notes: ¹According to sections 5.2 and 5.3 of RSS-Gen, Issue 5 the EUT does not have a stand-alone receiver neither scanner receiver, therefore exempt from receiver requirements.
EUT is an AC powered device.

6.7 ISED RSS-247, Issue 2, test results for digital transmission systems (DTS)

Table 6.7-1: ISED DTS requirements results

Part	Test description	Verdict
5.2 (a)	Minimum 6 dB bandwidth	Pass
5.2 (b)	Maximum power spectral density	Pass
5.3	Hybrid Systems	
5.3 (a)	Digital modulation turned off	Not applicable
5.3 (b)	Frequency hopping turned off	Not applicable
5.4	Transmitter output power and e.i.r.p. requirements	
5.4 (d)	Systems employing digital modulation techniques	Pass
5.4 (e)	Point-to-point systems in 2400–2483.5 MHz and 5725–5850 MHz band	Not applicable
5.4 (f)	Transmitters which operate in the 2400–2483.5 MHz band with multiple directional beams	Not applicable
5.5	Unwanted emissions	Pass

Section 7 Test equipment

7.1 Test equipment list

Table 7.1-1: Equipment list_Initial testing

Equipment	Manufacturer	Model no.	Asset no.	Cal cycle	Next cal.
3 m EMI test chamber	TDK	SAC-3	FA002047	1 year	January 24, 2021
Flush mount turntable	Sunol	FM2022	FA002082	—	NCR
Controller	Sunol	SC104V	FA002060	—	NCR
Antenna mast	Sunol	TLT2	FA002061	—	NCR
61505 AC source	Chroma	61509	FA003036	—	VOU
Receiver/spectrum analyzer	Rohde & Schwarz	ESU 26	FA002043	1 year	November 8, 2020
Spectrum analyzer	Rohde & Schwarz	FSU	FA001877	1 year	October 31, 2020
Horn (1–18 GHz)	ETS Lindgren	3117	FA002840	1 year	January 25, 2021
Horn antenna (1–18 GHz)	EMCO	3115	FA000825	1 year	October 31, 2020
Preamp (1–18 GHz)	ETS Lindgren	124334	FA002873	1 year	November 4, 2020
Preamp (1–18 GHz)	ETS Lindgren	124334	FA002877	1 year	November 4, 2020
Bilog antenna (20–3000 MHz)	Sunol	JB3	FA002108	1 year	January 14, 2021
LISN	Rohde & Schwarz	ENV216	FA002023	1 year	September 21, 2021
LISN	Rohde & Schwarz	ENV216	FA002515	1 year	January 18, 2021
Horn antenna (18–40 GHz)	EMCO	3116	FA001847	1 year	November 7, 2020
Pre-amplifier (18–26 GHz)	Narda	BBS-1826N612	FA001550	—	VOU
Notch Filter (2.4-2483.5 MHz)	Microwave Circuits	N0124413	FA002367	1 year	February 3, 2021

Note: NCR - no calibration required, VOU - verify on use

Table 7.1-2: Equipment list_Aditional testing

Equipment	Manufacturer	Model no.	Asset no.	Cal cycle	Next cal.
3 m EMI test chamber	TDK	SAC-3	FA002047	1 year	January 20, 2023
Flush mount turntable	Sunol	FM2022	FA002082	—	NCR
Controller	Sunol	SC104V	FA002060	—	NCR
Antenna mast	Sunol	TLT2	FA002061	—	NCR
Receiver/spectrum analyzer	Rohde & Schwarz	ESU 26	FA002043	1 year	November 25, 2022
Bilog antenna (20–3000 MHz)	Sunol	JB3	FA002108	1 year	February 14, 2023
50 Ω coax cable	C.C.A.	None	FA002556	1 year	April 24, 2022
50 Ω coax cable	Huber + Suhner	None	FA002830	1 year	April 24, 2022
LISN	Rohde & Schwarz	ENV216	FA002515	1 year	February 4, 2023
Horn (1–18 GHz)	ETS Lindgren	3117	FA002840	1 year	February 10, 2023
Preamp (1–18 GHz)	ETS Lindgren	124334	FA002873	1 year	September 22, 2022
Horn antenna (18–26.5 GHz)	Electro-metrics	SH-50/60-1	FA000479	—	VOU
Pre-amplifier (18–26 GHz)	Narda	BBS-1826N612	FA001550	—	VOU
Notch Filter (2.4-2483.5 MHz)	Microwave Circuits	N0124413	FA002367	1 year	VOU

Note: NCR - no calibration required, VOU - verify on use

Section 8 Testing data

8.1 Variation of power source

8.1.1 References, definitions and limits

FCC §15.31 (e):

For intentional radiators, measurements of the variation of the input power or the radiated signal level of the fundamental frequency component of the emission, as appropriate, shall be performed with the supply voltage varied between 85% and 115% of the nominal rated supply voltage. For battery operated equipment, the equipment tests shall be performed using a new battery.

8.1.2 Test summary

Verdict	Pass		
Tested by	Avul Nzenza	Test date	October 6, 2020

8.1.3 Observations, settings and special notes

The testing was performed as per ANSI C63.10 Section 5.13.

- Where the device is intended to be powered from an external power adapter, the voltage variations shall be applied to the input of the adapter provided with the device at the time of sale. If the device is not marketed or sold with a specific adapter, then a typical power adapter shall be used.
- For devices, where operating at a supply voltage deviating $\pm 15\%$ from the nominal rated value may cause damages or loss of intended function, test to minimum and maximum allowable voltage per manufacturer's specification and document in the report.
- For devices with wide range of rated supply voltage, test at 15% below the lowest and 15% above the highest declared nominal rated supply voltage.
- For devices obtaining power from an input/output (I/O) port (USB, firewire, etc.), a test jig is necessary to apply voltage variation to the device from a support power supply, while maintaining the functionalities of the device.

For battery-operated equipment, the equipment tests shall be performed using a variable power supply.

8.1.4 Test data

EUT Power requirements:

	<input checked="" type="checkbox"/> AC	<input type="checkbox"/> DC	<input type="checkbox"/> Battery
If EUT is an AC or a DC powered, was the noticeable output power variation observed?	<input type="checkbox"/> YES	<input checked="" type="checkbox"/> NO	<input type="checkbox"/> N/A
If EUT is battery operated, was the testing performed using fresh batteries?	<input type="checkbox"/> YES	<input type="checkbox"/> NO	<input checked="" type="checkbox"/> N/A
If EUT is rechargeable battery operated, was the testing performed using fully charged batteries?	<input type="checkbox"/> YES	<input type="checkbox"/> NO	<input checked="" type="checkbox"/> N/A

8.2 Number of frequencies

8.2.1 References, definitions and limits

FCC §15.31:

(m) Measurements on intentional radiators or receivers shall be performed and, if required, reported for each band in which the device can be operated with the device operating at the number of frequencies in each band specified in the following table.

RSS-Gen, Clause 6.9:

Except where otherwise specified, measurements shall be performed for each frequency band of operation for which the radio apparatus is to be certified, with the device operating at the frequencies in each band of operation shown in table below. The frequencies selected for measurements shall be reported in the test report.

Table 8.2-1: Frequency Range of Operation

Frequency range over which the device operates (in each band)	Number of test frequencies required	Location of measurement frequency inside the operating frequency range
1 MHz or less	1	Center (middle of the band)
1–10 MHz	2	1 near high end, 1 near low end
Greater than 10 MHz	3	1 near high end, 1 near center and 1 near low end

Notes: “near” means as close as possible to or at the centre / low end / high end of the frequency range over which the device operates.

8.2.2 Test summary

Verdict	Pass		
Tested by	Avul Nzenza	Test date	October 7, 2020

8.2.3 Observations, settings and special notes

ANSI C63.10, Clause 5.6.2.1:

The number of channels tested can be reduced by measuring the center channel bandwidth first and then applying the following relaxations as appropriate:

- For each operating mode, if the measured channel bandwidth on the middle channel is at least 150% of the minimum permitted bandwidth, then it is not necessary to measure the bandwidth on the high and low channels.
- For multiple-input multiple-output (MIMO) systems, if the measured channel bandwidth on testing the middle channel exceeds the minimum permitted bandwidth by more than 50% on one transmit chain, then it is not necessary to repeat testing on the other chains.
- If the measured channel bandwidth on the middle channel is less than 50% of the maximum permitted bandwidth, then it is not necessary to measure the bandwidth on the high and low channels.

ANSI C63.10, Clause 5.6.2.2:

For devices with multiple operating modes, measurements on the middle channel can be used to determine the worst-case mode(s). The worst-case modes are as follows:

- Band edge requirements—Measurements on the mode with the widest bandwidth can be used to cover the same channel (center frequency) on modes with narrower bandwidth that have the same or lower output power for each modulation family (e.g., OFDM and direct sequence spread spectrum).
- Spurious emissions—Measure the mode with the highest output power and the mode with the highest output power spectral density for each modulation family (e.g., OFDM and direct sequence spread spectrum).
- In-band PSD—Measurements on the mode with the narrowest bandwidth can be used to cover all modes within the same modulation family of an equal or lower output power provided the result is less than 50% of the limit.



8.2.4 Test data

Table 8.2-2: *Test channels selection*

Start of Frequency range, MHz	End of Frequency range, MHz	Frequency range bandwidth, MHz	Low channel, MHz	Mid channel, MHz	High channel, MHz
2400	2483.5	83.5	2402	2440	2480



8.3 Antenna requirement

8.3.1 References, definitions and limits

FCC §15.203:

An intentional radiator shall be designed to ensure that no antenna other than that furnished by the responsible party shall be used with the device. The use of a permanently attached antenna or of an antenna that uses a unique coupling to the intentional radiator shall be considered sufficient to comply with the provisions of this section. The manufacturer may design the unit so that a broken antenna can be replaced by the user, but the use of a standard antenna jack or electrical connector is prohibited. This requirement does not apply to intentional radiators that must be professionally installed, such as perimeter protection systems and some field disturbance sensors, or to other intentional radiators which, in accordance with §15.31(d), must be measured at the installation site. However, the installer shall be responsible for ensuring that the proper antenna is employed so that the limits in this part are not exceeded.

FCC §15.247:

- (b) The maximum peak conducted output power of the intentional radiator shall not exceed the following:
- (4) The conducted output power limit specified in paragraph (b) of this section is based on the use of antennas with directional gains that do not exceed 6 dBi. Except as shown in paragraph (c) of this section, if transmitting antennas of directional gain greater than 6 dBi are used, the conducted output power from the intentional radiator shall be reduced below the stated values in paragraphs (b)(1), (b)(2), and (b)(3) of this section, as appropriate, by the amount in dB that the directional gain of the antenna exceeds 6 dBi.

RSS-Gen, Clause 6.8:

The applicant for equipment certification shall provide a list of all antenna types that may be used with the transmitter, where applicable (i.e. for transmitters with detachable antenna), indicating the maximum permissible antenna gain (in dBi) and the required impedance for each antenna. The test report shall demonstrate the compliance of the transmitter with the limit for maximum equivalent isotropically radiated power (e.i.r.p.) specified in the applicable RSS, when the transmitter is equipped with any antenna type, selected from this list. For expediting the testing, measurements may be performed using only the antenna with highest gain of each combination of transmitter and antenna type, with the transmitter output power set at the maximum level. However, the transmitter shall comply with the applicable requirements under all operational conditions and when in combination with any type of antenna from the list provided in the test report.

8.3.2 Test summary

Verdict	Pass		
Tested by	Avul Nzenza	Test date	October 7, 2020

8.3.3 Observations, settings and special notes

None

8.3.4 Test data

- Must the EUT be professionally installed? YES NO
Does the EUT have detachable antenna(s)? YES NO
 If detachable, is the antenna connector(s) non-standard? YES NO N/A

Table 8.3-1: Antenna information

Antenna type	Manufacturer	Model number	Maximum gain	Connector type
Whip Tilt	PulseLarsen Antennas	W1010	2 dBi	SMA Male

8.4 AC power line conducted emissions limits

8.4.1 References, definitions and limits

FCC §15.207:

- (a) Except as shown in paragraphs (b) and (c) of this section, for an intentional radiator that is designed to be connected to the public utility (AC) power line, the radio frequency voltage that is conducted back onto the AC power line on any frequency or frequencies, within the band 150 kHz to 30 MHz, shall not exceed the limits in the following table, as measured using a 50 μ H/50 Ω line impedance stabilization network (LISN). Compliance with the provisions of this paragraph shall be based on the measurement of the radio frequency voltage between each power line and ground at the power terminal. The lower limit applies at the boundary between the frequency ranges.

ANSI C63.10, Clause 6.2:

If the EUT normally receives power from another device that in turn connects to the public utility ac power lines, measurements shall be made on that device with the EUT in operation to demonstrate that the device continues to comply with the appropriate limits while providing the EUT with power. If the EUT is operated only from internal or dedicated batteries, with no provisions for connection to the public utility ac power lines (600 VAC or less) to operate the EUT (such as an adapter), then ac power-line conducted measurements are not required.

For direct current (dc) powered devices where the ac power adapter is not supplied with the device, an “off-the-shelf” unmodified ac power adapter shall be used. If the device is supposed to be installed in a host (e.g., the device is a module or PC card), then it is tested in a typical compliant host.

RSS-Gen, Clause 8.8:

A radio apparatus that is designed to be connected to the public utility (AC) power line shall ensure that the radio frequency voltage, which is conducted back onto the AC power line on any frequency or frequencies within the band 150 kHz to 30 MHz, shall not exceed the limits in table below.

Unless the requirements applicable to a given device state otherwise, for any radio apparatus equipped to operate from the public utility AC power supply either directly or indirectly (such as with a battery charger), the radio frequency voltage of emissions conducted back onto the AC power lines in the frequency range of 0.15 MHz to 30 MHz shall not exceed the limits shown in table below. The more stringent limit applies at the frequency range boundaries.

Table 8.4-1: Conducted emissions limit

Frequency of emission, MHz	Conducted emissions limit, dB μ V	
	Quasi-peak	Average**
0.15–0.5	66 to 56*	56 to 46*
0.5–5	56	46
5–30	60	50

Notes: * - The level decreases linearly with the logarithm of the frequency.
 ** - A linear average detector is required.

8.4.2 Test summary

Verdict	Pass		
Tested by	Predrag Golic	Test date	April 6, 2022

8.4.3 Observations, settings and special notes

Port under test – Coupling device	AC input – Artificial Mains Network (AMN)
EUT power input during test	120 V _{AC} , 60 Hz
EUT setup configuration	Table top
Measurement details	A preview measurement was generated with the receiver in continuous scan mode. Emissions detected within 10 dB or above the limit were re-measured with the appropriate detector against the correlating limit and recorded as the final measurement.
Additional notes:	<ul style="list-style-type: none"> – The EUT was set up as tabletop configuration per ANSI C63.10-2013 measurement procedure. – The spectral scan has been corrected with transducer factors (i.e. cable loss, LISN factors, and attenuators) for determination of compliance. Correction factor (dB) = LISN factor IL (dB) + cable loss (dB) + attenuator (dB) – Emissions that were continuously present for a minimum of 1 second and occurred more than once for every 15 seconds observation period were considered valid emissions. The maximum value of valid emissions has been recorded.

Receiver settings:

Resolution bandwidth	9 kHz
Video bandwidth	30 kHz
Detector mode	Peak and Average (Preview), Quasi-peak and CAverage (Final)
Trace mode	Max Hold
Measurement time	100 ms (Preview), 160 ms (Final)

8.4.4 Test data

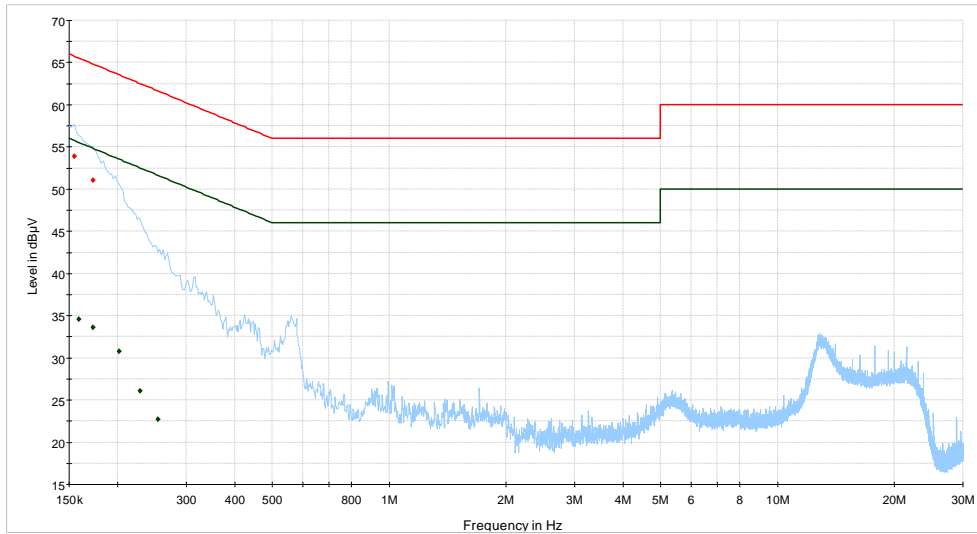

CE 120 VAC 60 Hz Line [Charging Mode]
 — Preview Result 1-PK+
 — CISPR 32 Limit - Class B, Mains (QP)
 — CISPR 32 Limit - Class B, Mains (Avg)
 ♦ Final_Result QPK
 ♦ Final_Result CAV

Plot 8.4-1: *Conducted emissions on phase line*

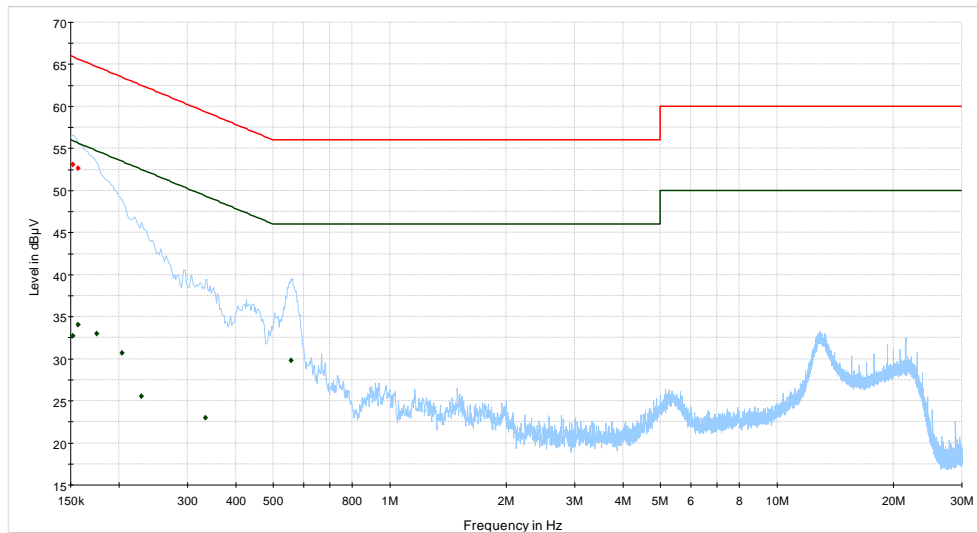

CE 120 VAC 60 Hz Neutral [Charging Mode]
 — Preview Result 1-PK+
 — CISPR 32 Limit - Class B, Mains (QP)
 — CISPR 32 Limit - Class B, Mains (Avg)
 ♦ Final_Result QPK
 ♦ Final_Result CAV

Plot 8.4-2: *Conducted emissions on neutral line*

8.5 Minimum 6 dB bandwidth for DTS systems

8.5.1 References, definitions and limits

FCC §15.247:

- (a) Operation under the provisions of this Section is limited to frequency hopping and digitally modulated intentional radiators that comply with the following provisions:
- (2) Systems using digital modulation techniques may operate in the 902–928 MHz, 2400–2483.5 MHz, and 5725–5850 MHz bands. The minimum 6 dB bandwidth shall be at least 500 kHz.

RSS-247, Clause 5.2:

DTSs include systems that employ digital modulation techniques resulting in spectral characteristics similar to direct sequence systems. The following applies to the bands 902-928 MHz and 2400-2483.5 MHz:

- a. The minimum 6 dB bandwidth shall be 500 kHz.

RSS-Gen, Clause 6.7:

6 dB bandwidth is defined as the frequency range between two points, one at the lowest frequency below and one at the highest frequency above the carrier frequency, at which the maximum power level of the transmitted emission is attenuated 6 dB below the maximum in-band power level of the modulated signal, where the two points are on the outskirts of the in-band emission.

For the 99% emission bandwidth, the trace data points are recovered and directly summed in linear power level terms. The recovered amplitude data points, beginning at the lowest frequency, are placed in a running sum until 0.5% of the total is reached, and that frequency recorded. The process is repeated for the highest frequency data points (starting at the highest frequency, at the right side of the span, and going down in frequency). This frequency is then recorded. The difference between the two recorded frequencies is the occupied bandwidth (or the 99% emission bandwidth).

8.5.2 Test summary

Verdict	Pass		
Tested by	Avul Nzenza	Test date	October 6, 2020

8.5.3 Observations, settings and special notes

The test was performed as per KDB 558074, section 8.2 with reference to ANSI C63.10 subclause 11.8.
 Spectrum analyser settings:

Resolution bandwidth	100 kHz
Video bandwidth	$\geq 3 \times \text{RBW}$
Frequency span	2 MHz
Detector mode	Peak
Trace mode	Max Hold



8.5.4 Test data

Table 8.5-1: 99% occupied bandwidth results

Frequency, MHz	99% occupied bandwidth, kHz
2402	1089
2440	1064
2480	1080

Notes: There is no 99% occupied bandwidth limit in the standard's requirements, the measurement results provided for information purposes only.

Table 8.5-2: 6 dB bandwidth results

Frequency, MHz	6 dB bandwidth, kHz	Minimum limit, kHz	Margin, kHz
2402	705.1	500.0	205.1
2440	692.3	500.0	192.3
2480	698.7	500.0	198.7

Test data, continued

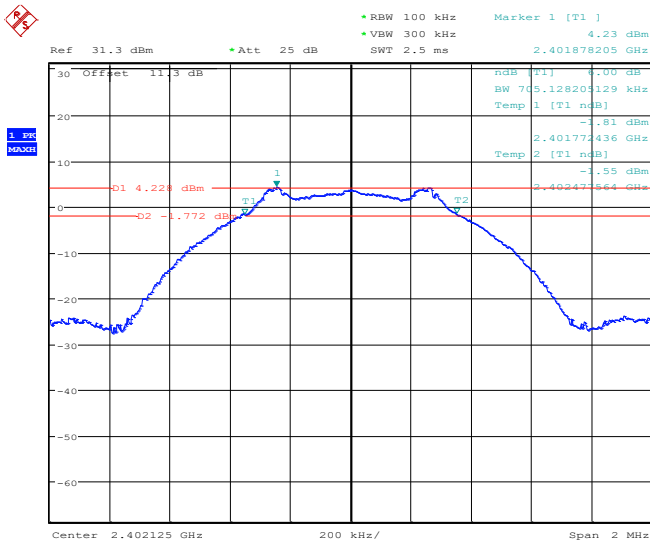

Figure 8.5-1: 6 dB bandwidth on low channel

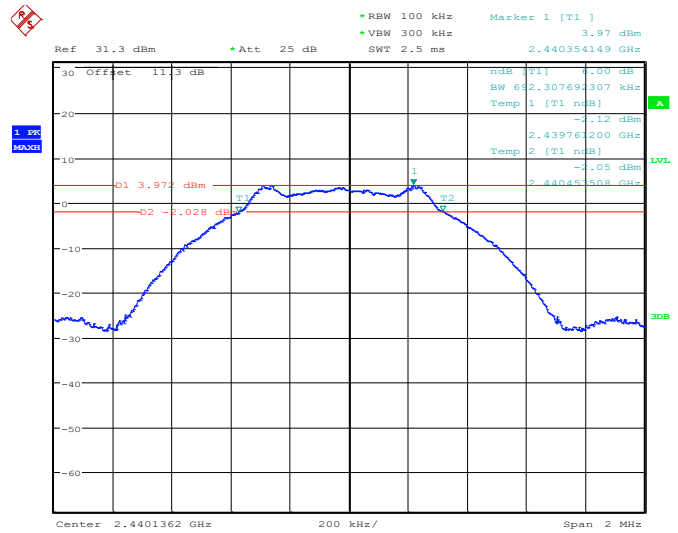

Figure 8.5-2: 6 dB bandwidth on mid channel

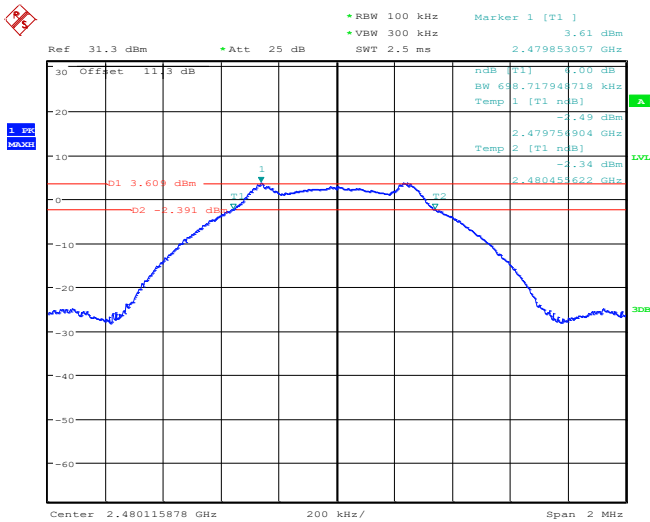

Figure 8.5-3: 6 dB bandwidth on high channel

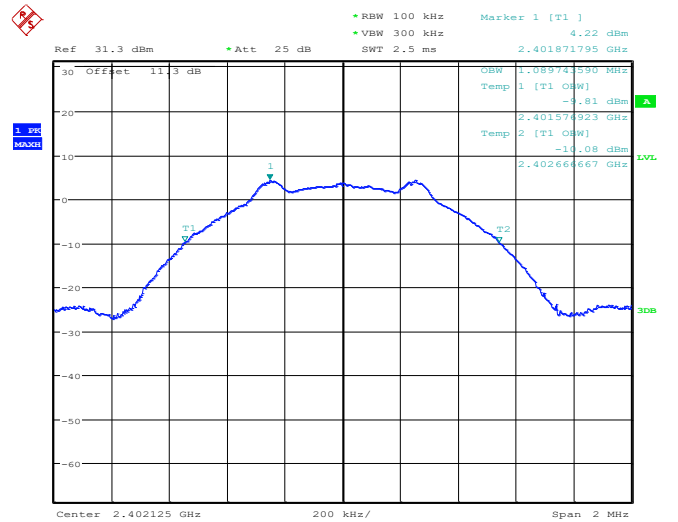

Figure 8.5-4: 99% occupied bandwidth - sample plot

8.6 Transmitter output power and e.i.r.p. requirements for DTS in 2.4 GHz

8.6.1 References, definitions and limits

FCC §15.247:

- (b) The maximum peak conducted output power of the intentional radiator shall not exceed the following:
- (3) For systems using digital modulation in the 2400–2483.5 MHz band: 1 W (30 dBm). As an alternative to a peak power measurement, compliance with the one Watt limit can be based on a measurement of the maximum conducted output power. Maximum Conducted Output Power is defined as the total transmit power delivered to all antennas and antenna elements averaged across all symbols in the signaling alphabet when the transmitter is operating at its maximum power control level. Power must be summed across all antennas and antenna elements. The average must not include any time intervals during which the transmitter is off or is transmitting at a reduced power level. If multiple modes of operation are possible (e.g., alternative modulation methods), the maximum conducted output power is the highest total transmit power occurring in any mode.
- (4) The conducted output power limit specified in paragraph (b) of this section is based on the use of antennas with directional gains that do not exceed 6 dBi. Except as shown in paragraph (c) of this section, if transmitting antennas of directional gain greater than 6 dBi are used, the conducted output power from the intentional radiator shall be reduced below the stated values in paragraphs (b)(1), (b)(2), and (b)(3) of this section, as appropriate, by the amount in dB that the directional gain of the antenna exceeds 6 dBi.
- (c) Operation with directional antenna gains greater than 6 dBi.
 - (1) Fixed point-to-point operation:
 - (i) Systems operating in the 2400–2483.5 MHz band that are used exclusively for fixed, point-to-point operations may employ transmitting antennas with directional gain greater than 6 dBi provided the maximum conducted output power of the intentional radiator is reduced by 1 dB for every 3 dB that the directional gain of the antenna exceeds 6 dBi.
 - (iii) Fixed, point-to-point operation, as used in paragraphs (c)(1)(i) and (c)(1)(ii) of this section, excludes the use of point-to-multipoint systems, omnidirectional applications, and multiple co-located intentional radiators transmitting the same information. The operator of the spread spectrum or digitally modulated intentional radiator or, if the equipment is professionally installed, the installer is responsible for ensuring that the system is used exclusively for fixed, point-to-point operations. The instruction manual furnished with the intentional radiator shall contain language in the installation instructions informing the operator and the installer of this responsibility.
 - (2) In addition to the provisions in paragraphs (b)(1), (b)(3), (b)(4) and (c)(1)(i) of this section, transmitters operating in the 2400–2483.5 MHz band that emit multiple directional beams, simultaneously or sequentially, for the purpose of directing signals to individual receivers or to groups of receivers provided the emissions comply with the following:
 - (i) Different information must be transmitted to each receiver.
 - (ii) If the transmitter employs an antenna system that emits multiple directional beams but does not do emit multiple directional beams simultaneously, the total output power conducted to the array or arrays that comprise the device, i.e., the sum of the power supplied to all antennas, antenna elements, staves, etc. and summed across all carriers or frequency channels, shall not exceed the limit specified in paragraph (b)(1) or (b)(3) of this section, as applicable. However, the total conducted output power shall be reduced by 1 dB below the specified limits for each 3 dB that the directional gain of the antenna/antenna array exceeds 6 dBi. The directional antenna gain shall be computed as follows:
 - (A) The directional gain shall be calculated as the sum of 10 log (number of array elements or staves) plus the directional gain of the element or stave having the highest gain.
 - (B) A lower value for the directional gain than that calculated in paragraph (c)(2)(ii)(A) of this section will be accepted if sufficient evidence is presented, e.g., due to shading of the array or coherence loss in the beamforming.
 - (iii) If a transmitter employs an antenna that operates simultaneously on multiple directional beams using the same or different frequency channels, the power supplied to each emission beam is subject to the power limit specified in paragraph (c)(2)(ii) of this section. If transmitted beams overlap, the power shall be reduced to ensure that their aggregate power does not exceed the limit specified in paragraph (c)(2)(ii) of this section. In addition, the aggregate power transmitted simultaneously on all beams shall not exceed the limit specified in paragraph (c)(2)(ii) of this section by more than 8 dB.
 - (iv) Transmitters that emit a single directional beam shall operate under the provisions of paragraph (c)(1) of this section.

References, definitions and limits, continued

RSS-247, Clause 5.4:

Devices shall comply with the following requirements, where applicable:

- d. For DTSs employing digital modulation techniques operating in the 2400–2483.5 MHz band,, the maximum peak conducted output power shall not exceed 1 W. The e.i.r.p. shall not exceed 4 W, except as provided in section 5.4(e).

As an alternative to a peak power measurement, compliance can be based on a measurement of the maximum conducted output power. The maximum conducted output power is the total transmit power delivered to all antennas and antenna elements, averaged across all symbols in the signalling alphabet when the transmitter is operating at its maximum power control level. Power must be summed across all antennas and antenna elements. The average must not include any time intervals during which the transmitter is off or transmitting at a reduced power level. If multiple modes of operation are implemented, the maximum conducted output power is the highest total transmit power occurring in any mode.

- e. Fixed point-to-point systems in the 2400–2483.5 MHz band are permitted to have an e.i.r.p. higher than 4 W provided that the higher e.i.r.p. is achieved by employing higher gain directional antennas and not higher transmitter output powers. Point-to-multipoint systems, omnidirectional applications and multiple co-located transmitters transmitting the same information are prohibited from exceeding an e.i.r.p. of 4 W.
- f. Transmitters operating in the band 2400–2483.5 MHz, may employ antenna systems that emit multiple directional beams simultaneously or sequentially, for the purpose of directing signals to individual receivers or to groups of receivers, provided that the emissions comply with the following:
 - i. Different information must be transmitted to each receiver.
 - ii. If the transmitter employs an antenna system that emits multiple directional beams, but does not emit multiple directional beams simultaneously, the total output power conducted to the array or arrays that comprise the device (i.e. the sum of the power supplied to all antennas, antenna elements, staves, etc., and summed across all carriers or frequency channels) shall not exceed the applicable output power limit specified in sections 5.4(b) and 5.4(d). However, the total conducted output power shall be reduced by 1 dB below the specified limits for each 3 dB that the directional gain of the antenna/antenna array exceeds 6 dBi. The directional antenna gain shall be computed as the sum of 10 log (number of array elements or staves) plus the directional gain of the element or staff having the highest gain.
 - iii. If a transmitter employs an antenna that operates simultaneously on multiple directional beams using the same or different frequency channels, the power supplied to each emission beam is subject to the applicable power limit specified in sections 5.4(b) and 5.4(d). If transmitted beams overlap, the power shall be reduced to ensure that their aggregate power does not exceed the applicable limit specified in sections 5.4(b) and 5.4(d). In addition, the aggregate power transmitted simultaneously on all beams shall not exceed the applicable limit specified in sections 5.4(b) and 5.4(d) by more than 8 dB.
 - iv. Transmitters that transmit a single directional beam shall operate under the provisions of sections 5.4(b), 5.4(d) and 5.4(e).

8.6.2 Test summary

Verdict	Pass		
Tested by	Avul Nzenza	Test date	October 6, 2020

8.6.3 Observations, settings and special notes

The test was performed as per KDB 558074, section 8.3 with reference to ANSI C63.10 subclause 11.9.1 (peak power) using method RBW≥DTS bandwidth (Maximum peak conducted output power)

Spectrum analyser settings:

Resolution bandwidth	1 MHz
Video bandwidth	≥3 × RBW
Frequency span	5 MHz
Detector mode	Peak
Trace mode	Max Hold

8.6.4 Test data

Table 8.6-1: Output power and EIRP results (antenna port measurement)

Frequency, MHz	Conducted output power, dBm	Output power limit, dBm	Output power margin, dB	Antenna gain, dBi	EIRP, dBm	EIRP limit, dBm	EIRP margin, dB
2402	4.64	30.00	25.36	2.00	6.64	36.00	29.36
2440	4.35	30.00	25.65	2.00	6.35	36.00	29.65
2480	4.03	30.00	25.97	2.00	6.03	36.00	29.97

Note: EIRP [dBm] = Conducted output power [dBm] + Antenna gain [dBi]

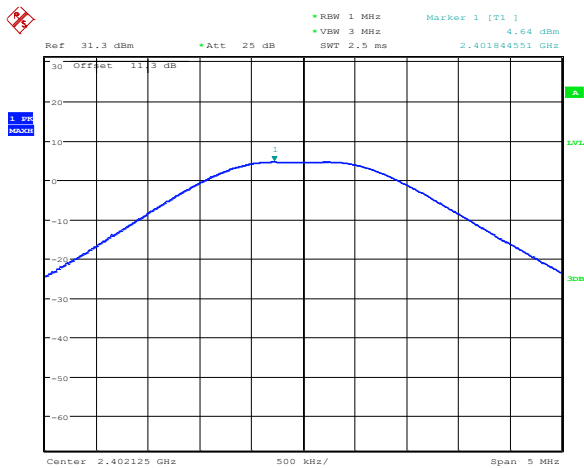

Figure 8.6-1: Output power on low channel

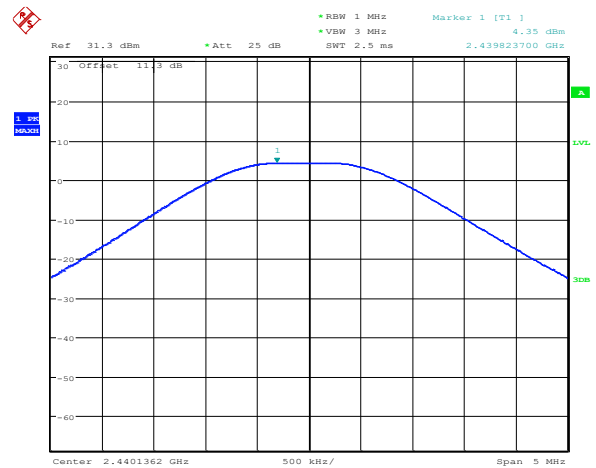

Figure 8.6-2: Output power on mid channel

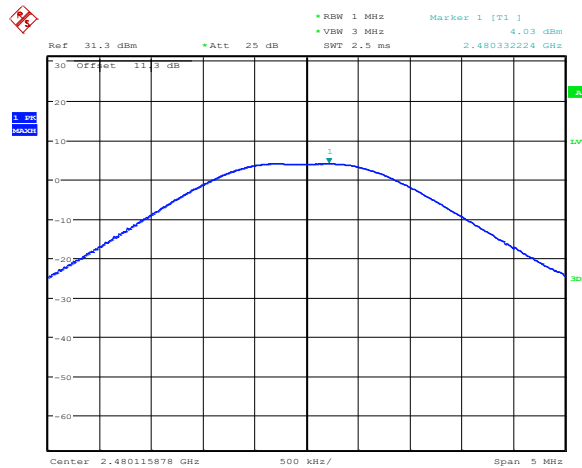

Figure 8.6-3: Output power on high channel

8.7 Spurious (out-of-band) unwanted emissions

8.7.1 References, definitions and limits

FCC §15.247:

- (d) In any 100 kHz bandwidth outside the frequency band in which the spread spectrum or digitally modulated intentional radiator is operating, the radio frequency power that is produced by the intentional radiator shall be at least 20 dB below that in the 100 kHz bandwidth within the band that contains the highest level of the desired power, based on either an RF conducted or a radiated measurement, provided the transmitter demonstrates compliance with the peak conducted power limits. If the transmitter complies with the conducted power limits based on the use of RMS averaging over a time interval, as permitted under paragraph (b)(3) of this section, the attenuation required under this paragraph shall be 30 dB instead of 20 dB. Attenuation below the general limits specified in §15.209(a) is not required. In addition, radiated emissions which fall in the restricted bands, as defined in §15.205(a), must also comply with the radiated emission limits specified in §15.209(a) (see §15.205(c)).

RSS-247, Clause 5.5:

In any 100 kHz bandwidth outside the frequency band in which the spread spectrum or digitally modulated device is operating, the RF power that is produced shall be at least 20 dB below that in the 100 kHz bandwidth within the band that contains the highest level of the desired power, based on either an RF conducted or a radiated measurement, provided that the transmitter demonstrates compliance with the peak conducted power limits. If the transmitter complies with the conducted power limits based on the use of root-mean-square averaging over a time interval, as permitted under section 5.4(d), the attenuation required shall be 30 dB instead of 20 dB. Attenuation below the general field strength limits specified in RSS-Gen is not required.

Table 8.7-1: FCC §15.209 and RSS-Gen – Radiated emission limits

Frequency, MHz	Field strength of emissions		Measurement distance, m
	μV/m	dBμV/m	
0.009–0.490	2400/F	$67.6 - 20 \times \log_{10}(F)$	300
0.490–1.705	24000/F	$87.6 - 20 \times \log_{10}(F)$	30
1.705–30.0	30	29.5	30
30–88	100	40.0	3
88–216	150	43.5	3
216–960	200	46.0	3
960–1800	500	54.0	3
1800–2500	500	63.5	1

Notes: In the emission table above, the tighter limit applies at the band edges.
 For frequencies above 1 GHz the limit on peak RF emissions is 20 dB above the maximum permitted average emission limit applicable to the equipment under test.

References, definitions and limits, continued

Table 8.7-2: ISED restricted frequency bands

MHz	MHz	MHz	GHz
0.090–0.110	12.57675–12.57725	399.9–410	7.25–7.75
0.495–0.505	13.36–13.41	608–614	8.025–8.5
2.1735–2.1905	16.42–16.423	960–1427	9.0–9.2
3.020–3.026	16.69475–16.69525	1435–1626.5	9.3–9.5
4.125–4.128	16.80425–16.80475	1645.5–1646.5	10.6–12.7
4.17725–4.17775	25.5–25.67	1660–1710	13.25–13.4
4.20725–4.20775	37.5–38.25	1718.8–1722.2	14.47–14.5
5.677–5.683	73–74.6	2200–2300	15.35–16.2
6.215–6.218	74.8–75.2	2310–2390	17.7–21.4
6.26775–6.26825	108–138	2483.5–2500	22.01–23.12
6.31175–6.31225	149.9–150.05	2655–2900	23.6–24.0
8.291–8.294	156.52475–156.52525	3260–3267	31.2–31.8
8.362–8.366	156.7–156.9	3332–3339	36.43–36.5
8.37625–8.38675	162.0125–167.17	3345.8–3358	
8.41425–8.41475	167.72–173.2	3500–4400	Above 38.6
12.29–12.293	240–285	4500–5150	
12.51975–12.52025	322–335.4	5350–5460	

Note: Certain frequency bands listed in Table 8.7-2 and above 38.6 GHz are designated for licence-exempt applications. These frequency bands and the requirements that apply to related devices are set out in the 200 and 300 series of RSSs.

Table 8.7-3: FCC restricted frequency bands

MHz	MHz	MHz	GHz
0.090–0.110	16.42–16.423	399.9–410	4.5–5.15
0.495–0.505	16.69475–16.69525	608–614	5.35–5.46
2.1735–2.1905	16.80425–16.80475	960–1240	7.25–7.75
4.125–4.128	25.5–25.67	1300–1427	8.025–8.5
4.17725–4.17775	37.5–38.25	1435–1626.5	9.0–9.2
4.20725–4.20775	73–74.6	1645.5–1646.5	9.3–9.5
6.215–6.218	74.8–75.2	1660–1710	10.6–12.7
6.26775–6.26825	108–121.94	1718.8–1722.2	13.25–13.4
6.31175–6.31225	123–138	2200–2300	14.47–14.5
8.291–8.294	149.9–150.05	2310–2390	15.35–16.2
8.362–8.366	156.52475–156.52525	2483.5–2500	17.7–21.4
8.37625–8.38675	156.7–156.9	2690–2900	22.01–23.12
8.41425–8.41475	162.0125–167.17	3260–3267	23.6–24.0
12.29–12.293	167.72–173.2	3332–3339	31.2–31.8
12.51975–12.52025	240–285	3345.8–3358	36.43–36.5
12.57675–12.57725	322–335.4	3600–4400	Above 38.6
13.36–13.41			

8.7.2 Test summary

Verdict	Pass		
Tested by	Predrag Golic	Test date	April 7 & 8, 2022

8.7.3 Observations, settings and special notes

- As part of the current assessment, the test range of 9 kHz to 10th harmonic has been fully considered and compared to the actual frequencies utilized within the EUT. Since the EUT contains a transmitter in the GHz range, the EUT has been deemed compliant without formal testing in the 9 kHz to 30 MHz test range, therefore formal test results (tabular data and/or plots) are not provided within this test report.
- Radiated measurements were performed at a distance of 3 m.
- DTS emissions in non-restricted frequency bands test was performed as per KDB 558074, section 8.5 with reference to ANSI C63.10 subclause 11.11.
- Since fundamental power was tested using the maximum peak conducted output power procedure to demonstrate compliance, the spurious emissions limit is –20 dBc/100 kHz.
- DTS emissions in restricted frequency bands test was performed as per KDB 558074, section 8.6 with reference to ANSI C63.10 subclause 11.12.
- DTS band-edge emission measurements test was performed as per KDB 558074, section 8.7 with reference to ANSI C63.10 subclause 11.13.
- Average was calculated from peak results using duty cycle correction factor (DCCF).

Spectrum analyser settings for radiated measurements within restricted bands below 1 GHz:

Resolution bandwidth:	100 kHz
Video bandwidth:	300 kHz
Detector mode:	Peak
Trace mode:	Max Hold

Spectrum analyser settings for peak radiated measurements within restricted bands above 1 GHz:

Resolution bandwidth:	1 MHz
Video bandwidth:	3 MHz
Detector mode:	Peak
Trace mode:	Max Hold

Spectrum analyser settings for conducted spurious emissions measurements:

Resolution bandwidth:	100 kHz
Video bandwidth:	300 kHz
Detector mode:	Peak
Trace mode:	Max Hold

8.7.4 Test data

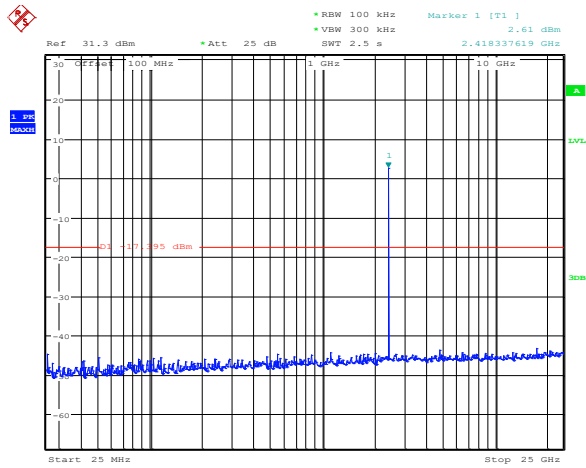

Figure 8.7-1: Conducted spurious (out-of-band) emissions, low channel

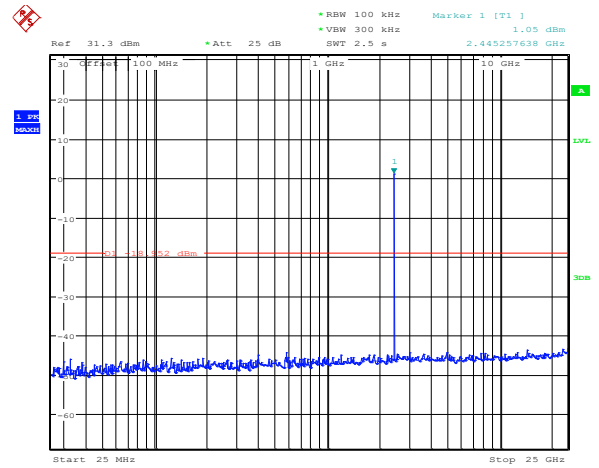

Figure 8.7-2: Conducted spurious (out-of-band) emissions, mid channel

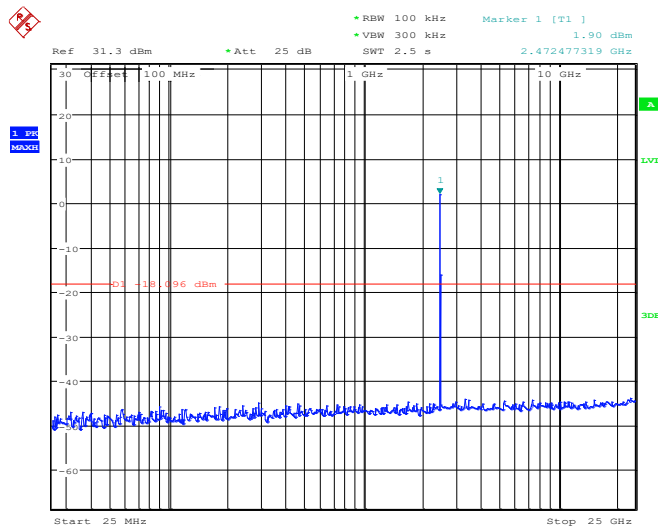

Figure 8.7-3: Conducted spurious (out-of-band) emissions, high channel

Test data, continued

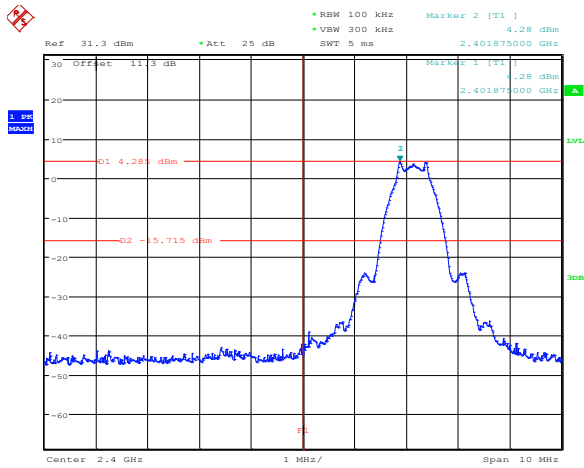

Figure 8.7-4: Conducted spurious (out-of-band) emissions Lower band, low channel)

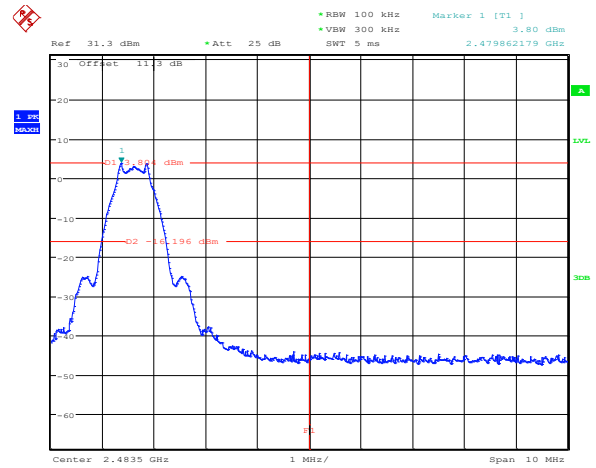
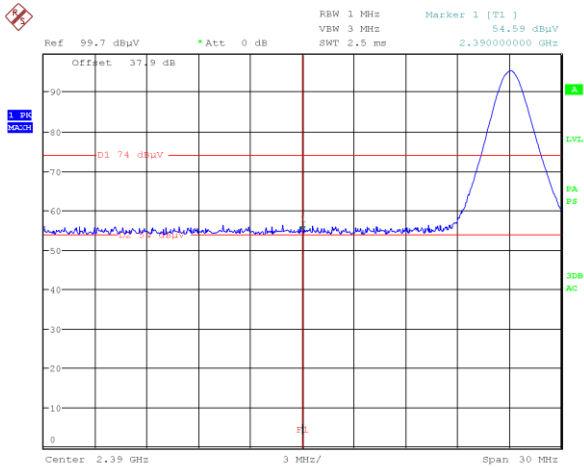
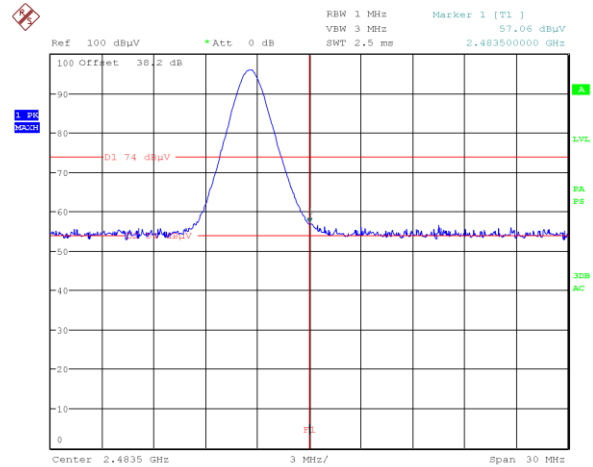

Figure 8.7-5: Conducted spurious (out-of-band) emissions upper band, high channel



Date: 7.APR.2022 19:38:20

Figure 8.7-6: Radiated spurious (out-of-band) emissions Lower band, low channel)



Date: 7.APR.2022 19:22:24

Figure 8.7-7: Radiated spurious (out-of-band) emissions upper band, high channel)

Test data, continued

Duty cycle correction

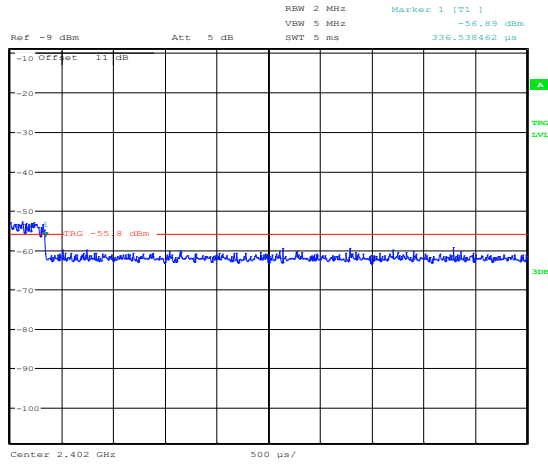

Figure 8.7-8: Pulse width

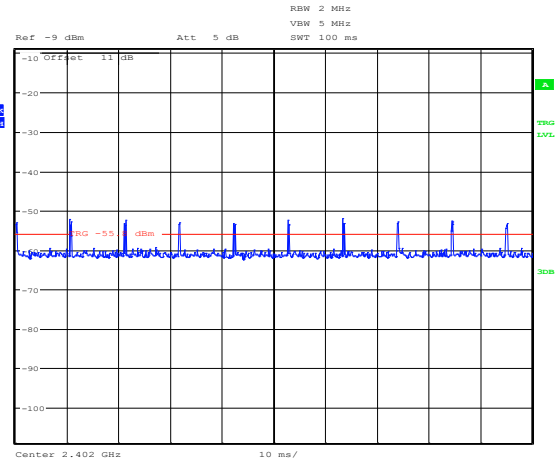

Figure 8.7-9: Pulses per 100 ms

Pulse width = 0.336 ms; 10 Pulses per 100 ms
DCCF = MAX(-20 dB or $20 \times \text{Log}_{10}(3.36 / 100)$) = -29.5 dB)

Table 8.7-4: Radiated field strength measurement results

Channel	Frequency, MHz	Peak Field strength, dBμV/m		Margin, dB	Average Field strength, dBμV/m		Margin, dB
		Measured	Limit		Calculated	Limit	
Low	2390.0	54.59	74.00	19.41	34.59	54.00	19.41
High	2483.5	57.06	74.00	16.94	37.06	54.00	16.94

Notes: Field strength includes correction factor of antenna, cable loss, amplifier, and attenuators where applicable.
Average field strength was calculated: Peak field strength + DCCF (-20 dB)

Test data, continued

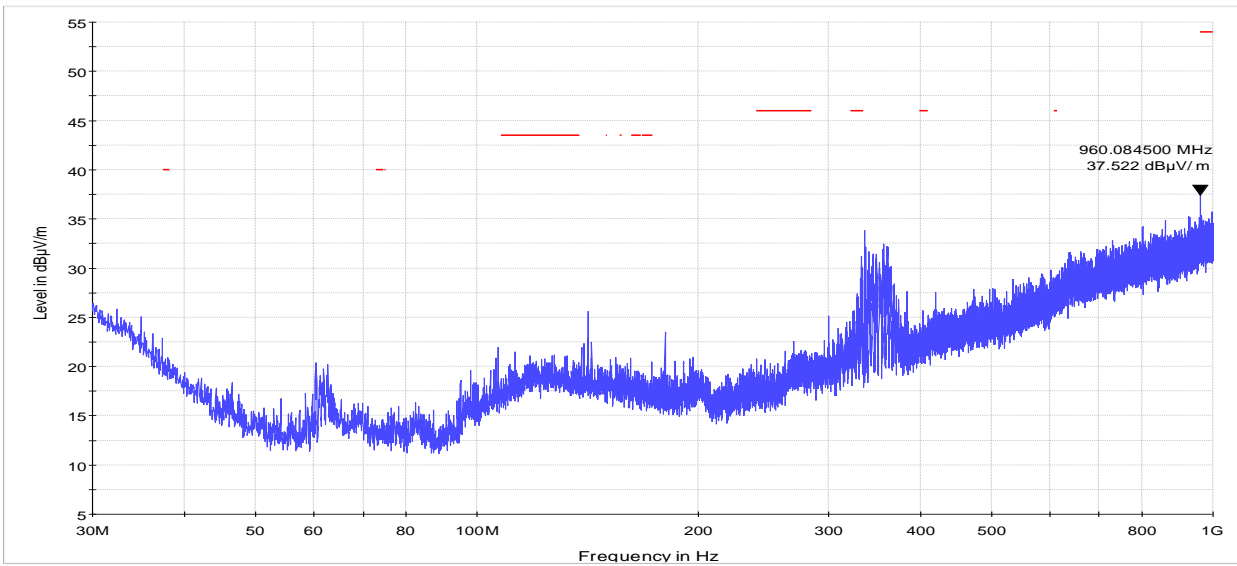

PK+_MAXH
 FCC 15.209 and RSS-Gen Restricted bands QP limit

Figure 8.7-10: Radiated spurious (out-of-band) emissions, below 1 GHz, Low channel

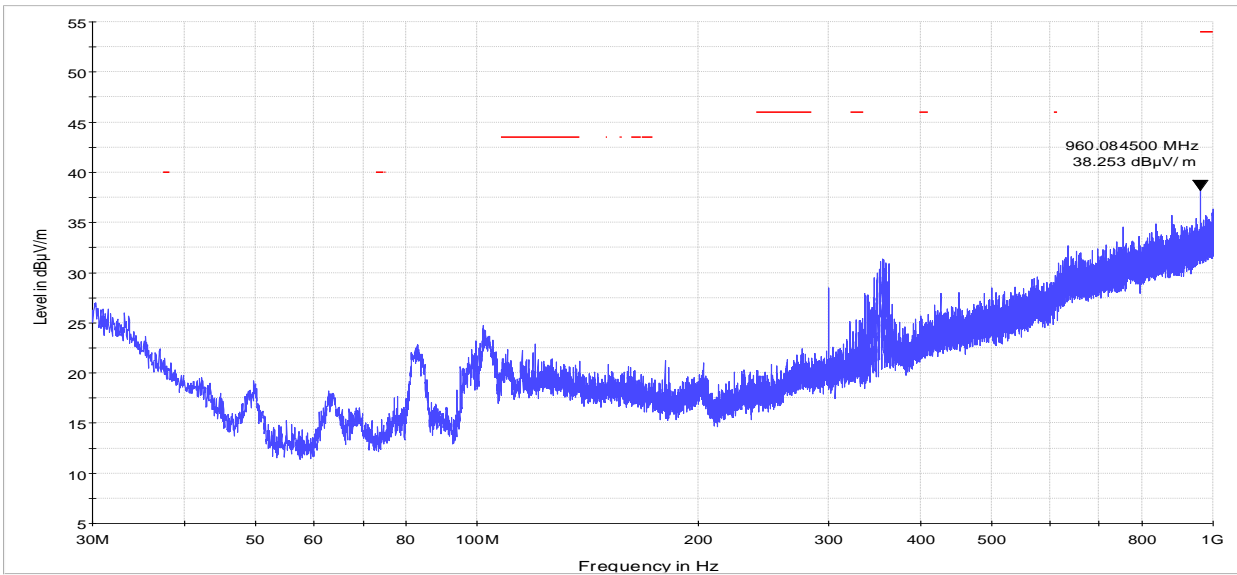

PK+_MAXH
 FCC 15.209 and RSS-Gen Restricted bands QP limit

Figure 8.7-11: Radiated spurious (out-of-band) emissions, below 1 GHz, Mid channel

Test data, continued

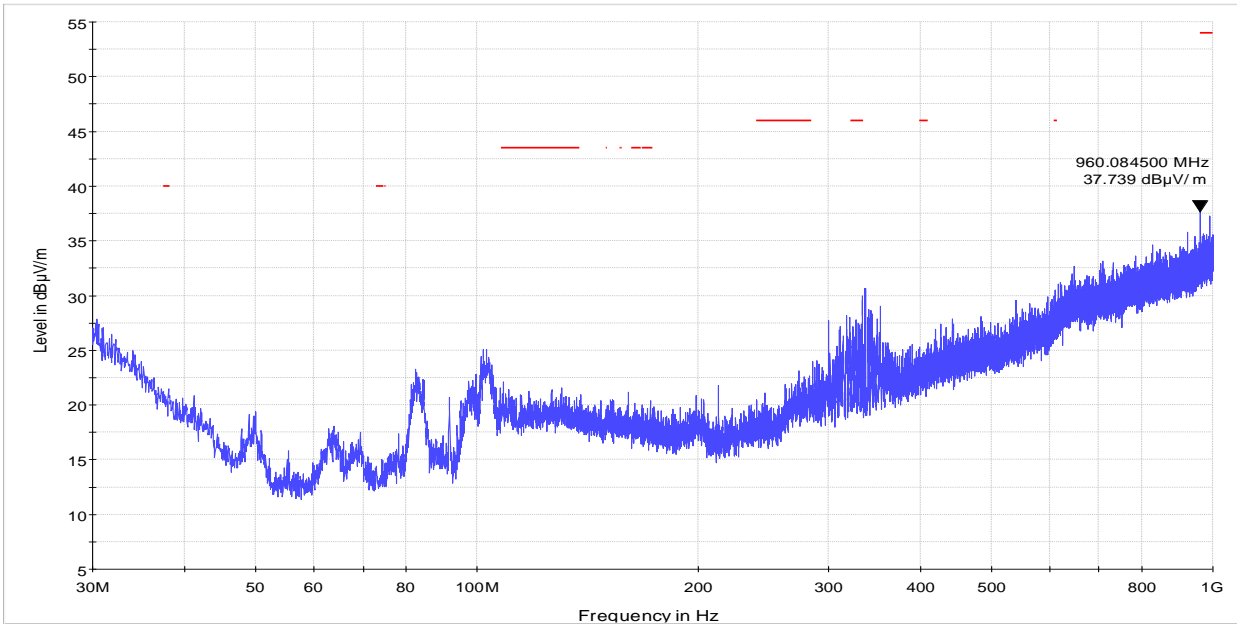

— PK+_MAXH
 - - - - - FCC 15.209 and RSS-Gen Restricted bands QP limit

Figure 8.7-12: Radiated spurious (out-of-band) emissions, below 1 GHz, high channel

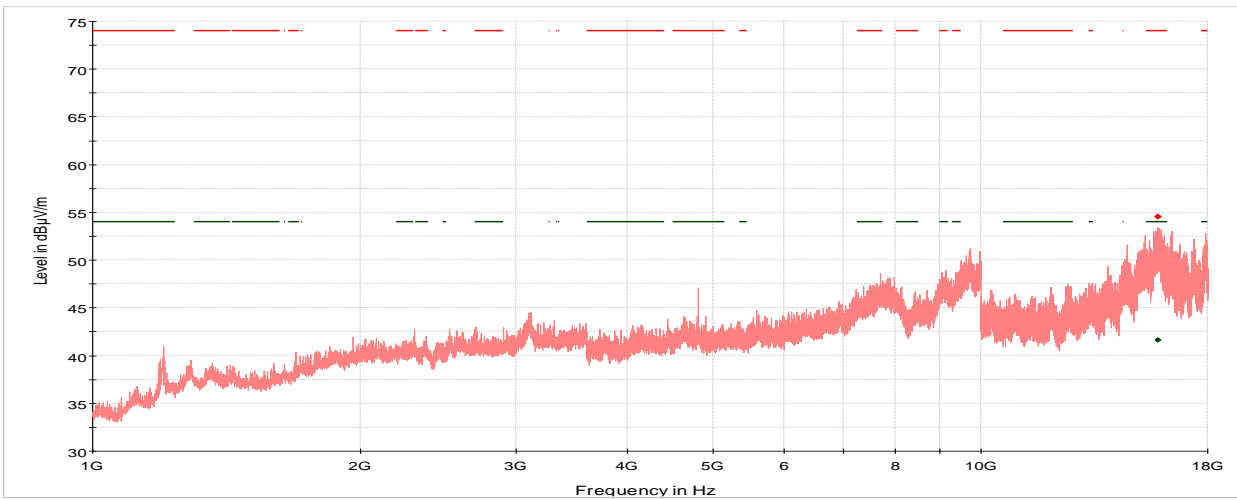

• MaxPeak-PK+ (Single)
 — PK+_MAXH
 - - - - - FCC 15.209 and RSS-Gen Restricted bands average limits
 - - - - - FCC 15.209 and RSS-Gen Restricted bands peak limits
 • CAverage-CAV (Single)

Figure 8.7-13: Radiated spurious (out-of-band) emissions, 1 GHz to 18 GHz, Low channel

Test data, continued

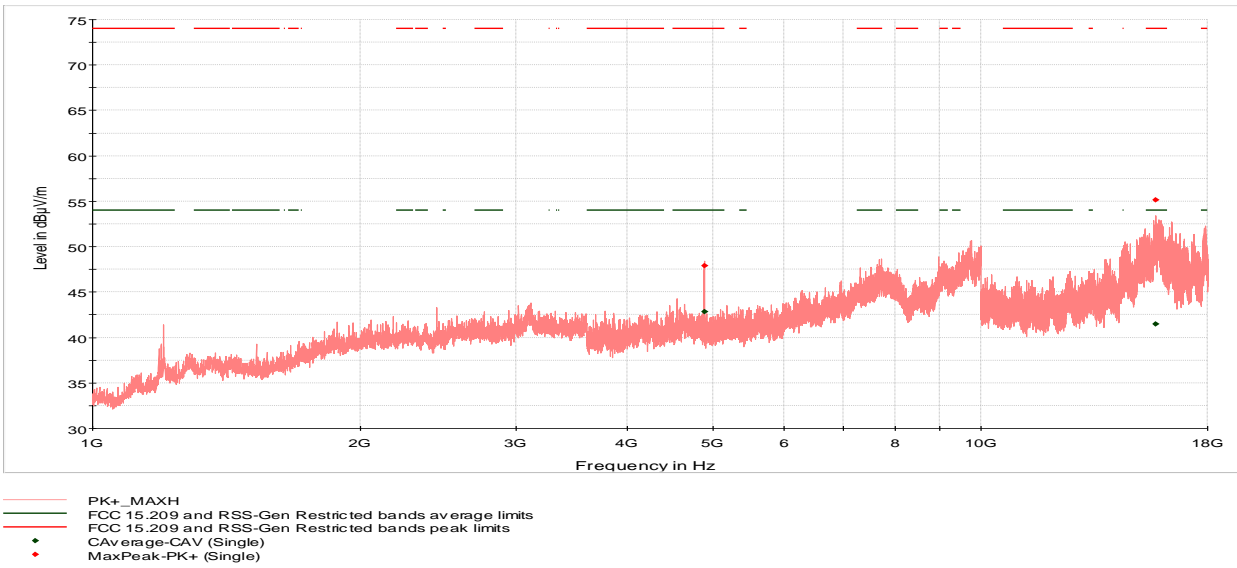

Figure 8.7-14: Radiated spurious (out-of-band) emissions, 1 GHz to 18 GHz, Mid channel

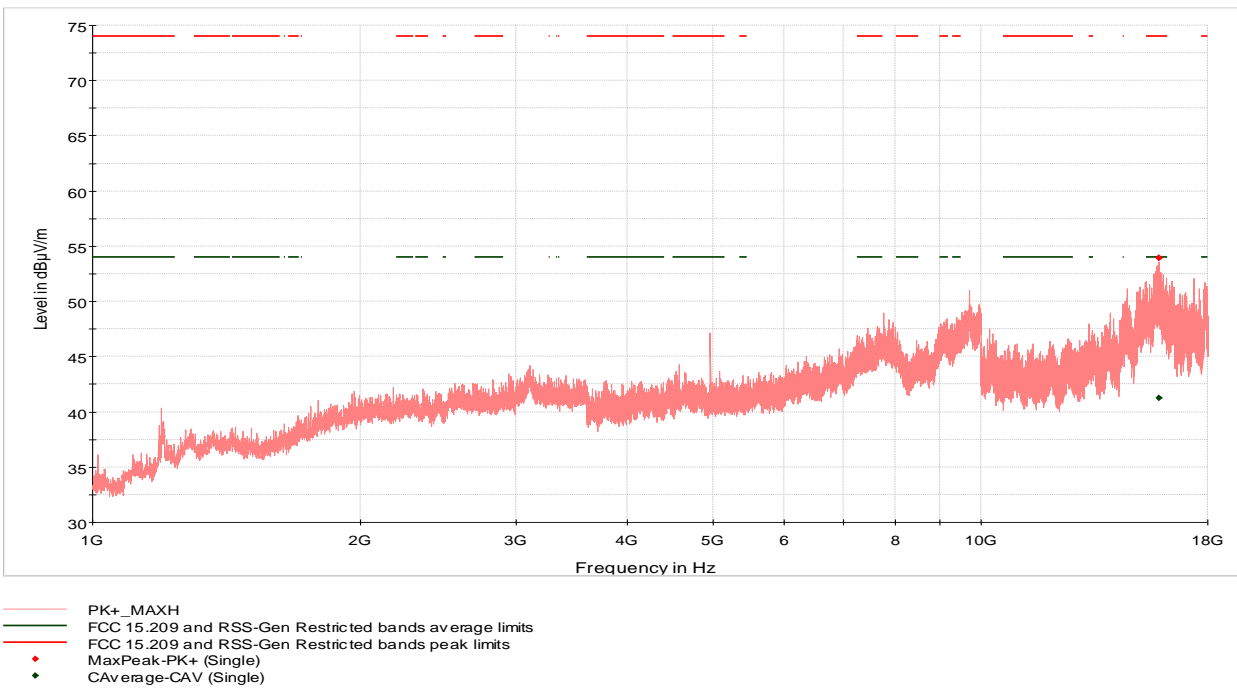
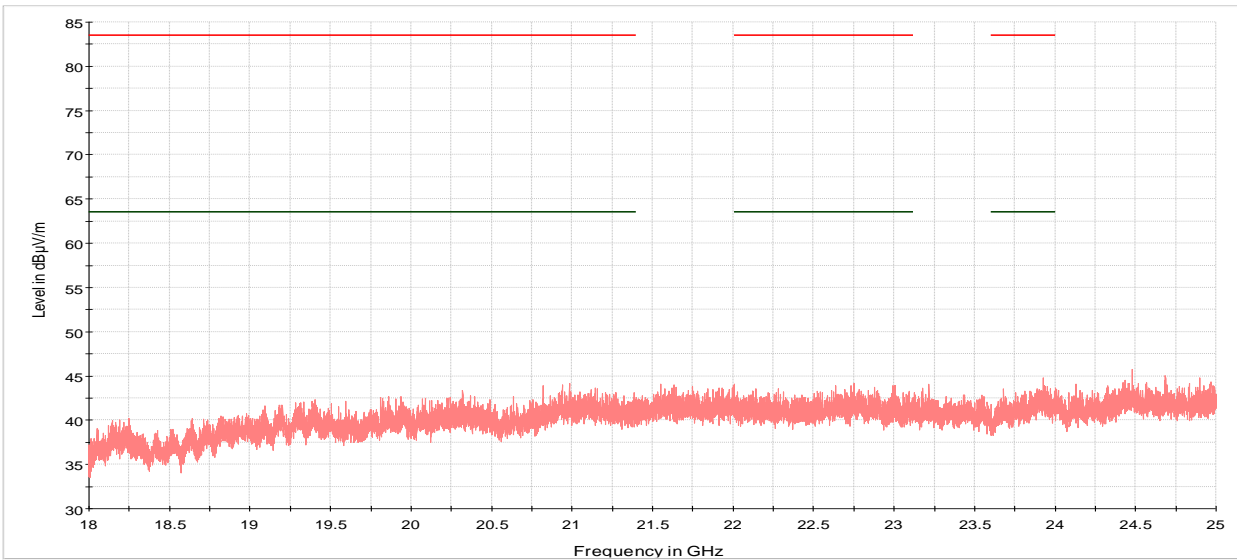

Figure 8.7-15: Radiated spurious (out-of-band) emissions, 1 GHz to 18 GHz, high channel

Test data, continued



- PK+ _MAXH
- FCC 15.209 and RSS-Gen Restricted bands peak limits_9dB5
- FCC 15.209 and RSS-Gen Restricted bands average limits_9dB5

Figure 8.7-16: Radiated spurious (out-of-band) emissions, 18 GHz to 25 GHz, Low channel

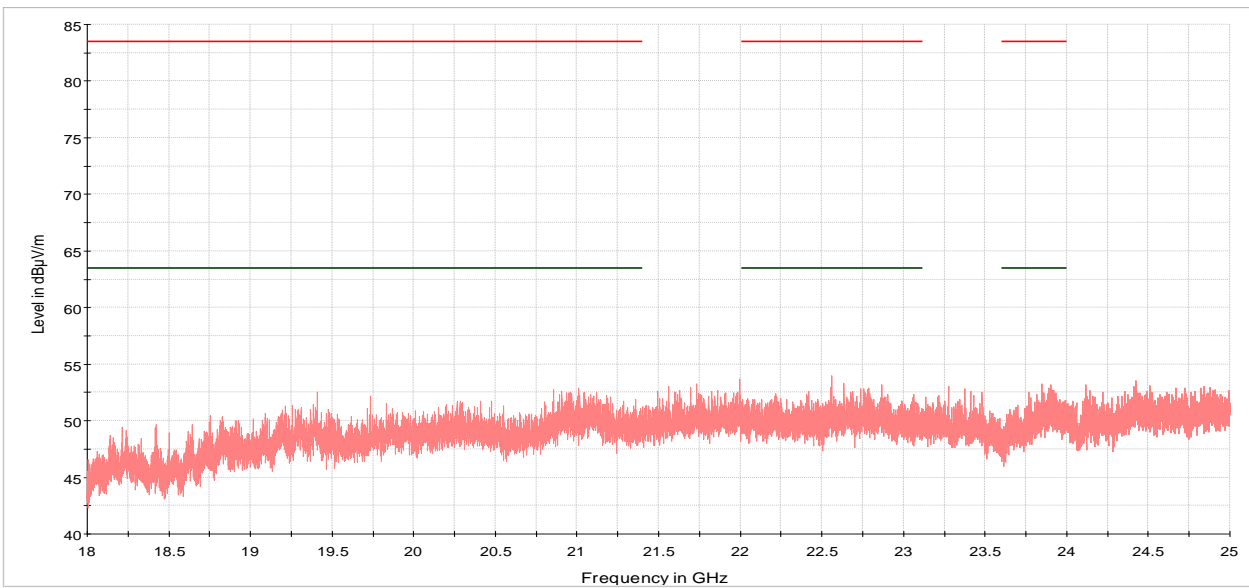

- PK+ _MAXH
- FCC 15.209 and RSS-Gen Restricted bands peak limits_9dB5
- FCC 15.209 and RSS-Gen Restricted bands average limits_9dB5

Figure 8.7-17: Radiated spurious (out-of-band) emissions, 18 GHz to 25 GHz, Mid channel

Test data, continued

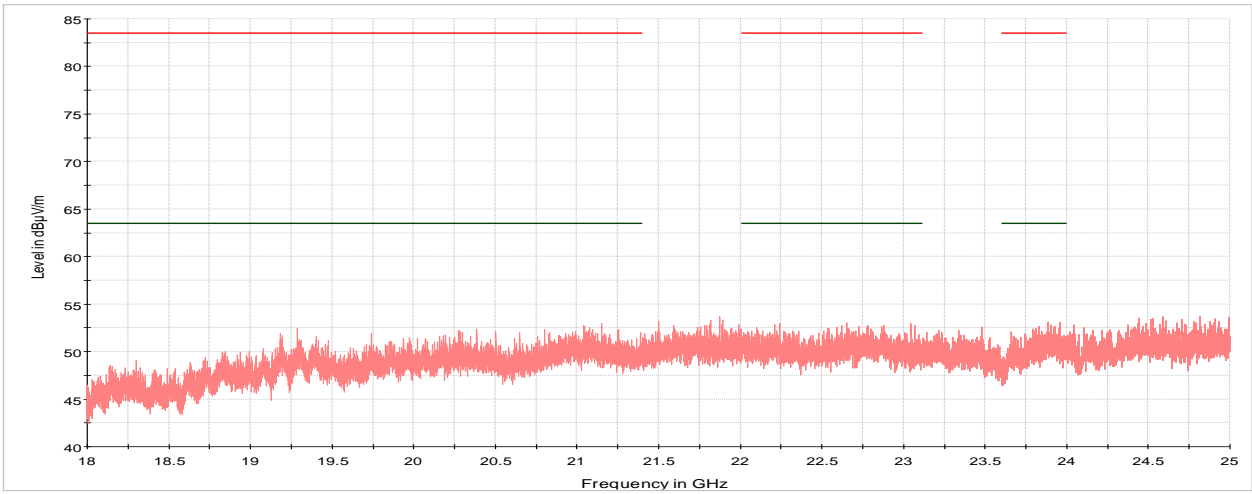

PK+_MAXH
FCC 15.209 and RSS-Gen Restricted bands peak limits_9dB5
FCC 15.209 and RSS-Gen Restricted bands average limits_9dB5

Figure 8.7-18: Radiated spurious (out-of-band) emissions, 18 GHz to 25 GHz, high channel

8.8 Power spectral density for digitally modulated devices

8.8.1 References, definitions and limits

FCC §15.247:

- (e) For digitally modulated systems, the power spectral density conducted from the intentional radiator to the antenna shall not be greater than 8 dBm in any 3 kHz band during any time interval of continuous transmission. This power spectral density shall be determined in accordance with the provisions of paragraph (b) of this section. The same method of determining the conducted output power shall be used to determine the power spectral density.
- (f) For the purposes of this section, hybrid systems are those that employ a combination of both frequency hopping and digital modulation techniques. The frequency hopping operation of the hybrid system, with the direct sequence or digital modulation operation turned-off, shall have an average time of occupancy on any frequency not to exceed 0.4 seconds within a time period in seconds equal to the number of hopping frequencies employed multiplied by 0.4. The power spectral density conducted from the intentional radiator to the antenna due to the digital modulation operation of the hybrid system, with the frequency hopping operation turned off, shall not be greater than 8 dBm in any 3 kHz band during any time interval of continuous transmission.

RSS-247, Clause 5.2:

DTSs include systems that employ digital modulation techniques resulting in spectral characteristics similar to direct sequence systems. The following applies to the bands 902-928 MHz and 2400-2483.5 MHz:

- b. The transmitter power spectral density conducted from the transmitter to the antenna shall not be greater than 8 dBm in any 3 kHz band during any time interval of continuous transmission. This power spectral density shall be determined in accordance with the provisions of section 5.4(d), (i.e. the power spectral density shall be determined using the same method as is used to determine the conducted output power).

RSS-247, Clause 5.3:

Hybrid systems employ a combination of both frequency hopping and digital transmission techniques and shall comply with the following:

- b. With the frequency hopping turned off, the digital transmission operation shall comply with the power spectral density requirements for digital modulation systems set out in of section 5.2(b) or section 6.2.4 for hybrid devices operating in the band 5725–5850 MHz.

8.8.2 Test summary

Verdict	Pass		
Tested by	Avul Nzenza	Test date	October 8, 2020

8.8.3 Observations, settings and special notes

Power spectral density test was performed as per KDB 558074, section 8.4 with reference to ANSI C63.10 subclause 11.10. The test was performed using method PKPSD (peak PSD).
 Spectrum analyser settings:

Spectrum analyser settings:

Resolution bandwidth:	3 kHz ≤ RBW ≤ 100 kHz
Video bandwidth:	≥ 3 × RBW
Frequency span:	1.5 times the DTS BW (Peak)
Detector mode:	Peak
Trace mode:	Max Hold

8.8.4 Test data

Table 8.8-1: PSD results (antenna port measurement)

Frequency, MHz	PSD, dBm/3 kHz	PSD limit, dBm/3 kHz	Margin, dB
2402	-5.19	8.0	13.19
2440	-5.80	8.0	13.80
2480	-6.16	8.0	14.16

Note: $EIRPSD [dBm/3 \text{ kHz}] = \text{Field Strength} [dB\mu V/m/3 \text{ kHz}] - 95.23 [dB]$; $PSD [dBm/3 \text{ kHz}] = EIRP [dBm/3 \text{ kHz}] - \text{Antenna gain} [dBi]$

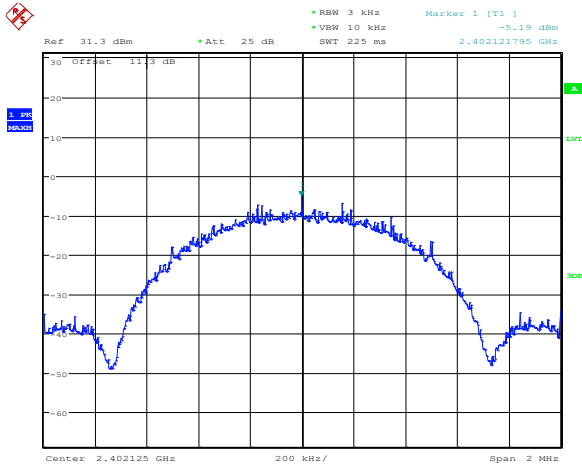

Date: 9.OCT.2020 13:58:47

Figure 8.8-1: PSD on low channel

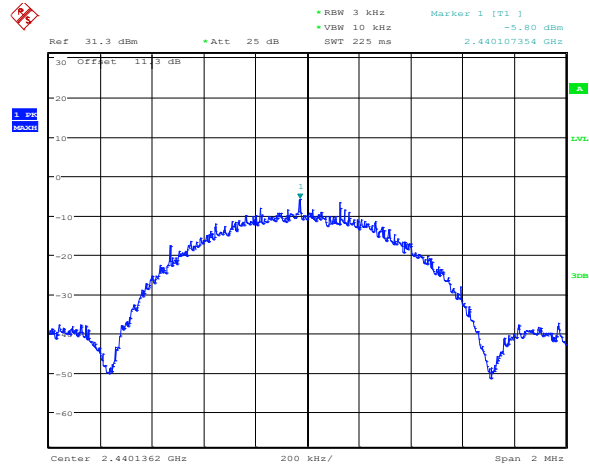

Date: 9.OCT.2020 07:13:28

Figure 8.8-2: PSD on mid channel

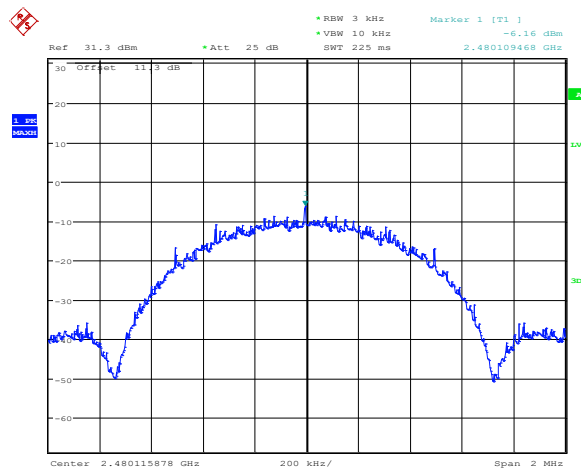

Date: 9.OCT.2020 07:24:26

Figure 8.8-3: PSD on high channel

Section 9 EUT photos

9.1 External photos



Figure 9.1-1: EUT photos

External photos, continued



Figure 9.1-2: EUT photos

End of the test report