

Guardian UHF™ 5W (3996152) Class B Public Safety BDA For First Responders



Long Island City, NY, 11101
<https://toweriq.nyc>
© 2021 TowerIQ, Inc

Document 1.19.0000055 Rev A
01/23/24

FCC NOTICE

The TowerIQ Guardian UHF 5W (3996152) signal booster is Class B booster. Under Section 90.219(d)(5) of the Commission's rules, all Part 90 Class B signal booster installations must be registered with the FCC.

NOTE: This equipment has been tested and found to comply with the limits for a Class B digital device, pursuant to part 15 of the FCC Rules. These limits are designed to provide reasonable protection against harmful interference in a commercial environment. This equipment generates, uses and can radiate radio frequency energy and, if not installed and used in accordance with the instructions, may cause harmful interference to radio communications. Operation of this equipment in a residential area is likely to cause harmful interference in which the user will be required to correct the interference at his own expense.

Filing Registrations. To register a Part 90 Class B signal booster, go to the Part 90 Signal Booster Registration and Discovery page at www.fcc.gov/signal-boosters/registration. Enter an FCC Registration Number (FRN) and Password in the upper-right corner of the screen. Then click on "LOGIN."

On the Signal Booster Information page, enter either (1) latitude and longitude (in decimal degrees) of the booster location and click on the "Get Address Info" button; or (2) the booster, city, and state, and click on the "Get Lat/Long button. The registration tool will provide a map of the booster location to verify the location is correct. Next, check the box(es) for the frequencies within the operating range of the signal booster and enter at least one call sign associated with the booster. Then enter the filer's Company Information (Company Name, Company Attention, Address, Email registration, enter Signature Information (Title, Name), and click "Submit." The system will generate a confirmation, including a booster ID number, which you may print for your records. Each booster must be submitted separately. Using the links in the upper-right corner of the Signal Booster Confirmation page, you can "Add a Booster," "View Your Boosters" or "Log out."

Accessing Registrations. Each registration will be available to the public on the same day it is filed with the Commission. Registrations may be accessed at: www.fcc.gov/signal-boosters/registration. Click on "View All Boosters" from the Part 90 Signal Booster Registration and Discovery page. The registrations can be searched and sorted by booster ID number, name of the filer, city, county, state, zip code, latitude/longitude, or call sign.

For further information please contact the FCC Licensing Support Hotline at (877) 480-3201 or submit an online help request at <https://esupport.fcc.gov/onlinerequest.htm>. Support hours are Monday thru Friday, 8:00–6:00 p.m. Eastern Time, except for Federal holidays.

Applicant's name: TowerIQ, Inc.
Address: 13723 Riverport Drive
C/O Potter Electric Signal Company
Saint Louis, MO 63043
Contact person: michaelm@pottersignal.com; Call: 314-683-2218

FCC Contact information is <https://signalboosters.fcc.gov/signal-boosters/Federal>
Communications Commission
45 L Street NE
Washington, DC 20554
Phone: 1-888-225-5322
TTY: 1-888-835-5322

TABLE OF CONTENTS

FCC NOTICE	1
TABLE OF CONTENTS	2
CHAPTER 1: INTRODUCTION & OVERVIEW	3
1.1 Product Overview	3
1.2 Package Contents	3
1.3 Additional Items Needed	3
1.4 Key Features & Benefits	3
1.5 Optional Accessories	4
1.6 How it Works	5
1.7 A Word About Safety	5
1.8 Warning Notices:	5
CHAPTER 2: BDA INTERFACE & CONNECTIONS	6
2.1 Guardian UHF 5W BDA Interface Overview	6
2.2 ON/OFF Switch	7
2.3 RF Interfaces (A1, A2, A3 and A4)	7
2.4 Power Wiring for AC and DC Power for 24V Battery Backup Power Supply	8
2.5 GUI interface	8
2.6 Fire Alarm I/O Interface	9
2.7 VSWR Alert Trigger Criteria	10
2.8 Oscillation Detected Alert Trigger Criteria	11
2.9 Component Alert Trigger Criteria	12
2.10 Load Restrictions	12
2.11 Ethernet Interface	12
2.12 USB Interface	13
6.1 Alarm LEDs	14
CHAPTER 3: PLANNING THE INSTALLATION	15
3.1 Installation Overview	15
3.2 Exterior Antenna Overview	15
3.3 Interior Antenna Overview	16
3.4 Antenna Separation	16
3.5 BDA Location	18
3.6 Accessories	18
3.7 Need Help?	18
CHAPTER 4: INSTALLATION	19
4.1 Soft Installation	19
4.2 Exterior Antenna	19
4.3 Interior Antennas	20
4.4 Mounting the BDA	21
CHAPTER 5: CONFIGURATION & TESTING	22
5.1 Powering on the BDA	22
CHAPTER 6: MAINTENANCE AND TROUBLESHOOTING	23
6.1 Frequency Band LED Conditions	23
6.2 LED Conditions	23
6.3 System Maintenance	23
6.4 Testing & Troubleshooting	23
CHAPTER 7: SENTRY CONFIGURATION & MONITORING	23
7.1 Sentry Software Introduction	23
7.2 Software Installation	24
7.3 Hardware Installation	25
7.4 User Registration	26
7.6 Device Registration	27
7.5 Device Configuration	27
7.6 Sentry Operation	29
CHAPTER 8: SPECIFICATIONS	32
CHAPTER 9: SAFETY AND COMPLIANCE	33
CHAPTER 10: WARRANTY	34
10.1 Warranty Periods	34
10.2 Three-Year Product Warranty	34
10.3 Limitations of Warranty, Damages and Liability	34

CHAPTER 1: INTRODUCTION & OVERVIEW

1.1 Product Overview

The Guardian UHF is a Class B, 5-watt, bi-directional amplifier with a maximum gain of 90dB supporting the UHF Public Safety frequency bands.

In the majority of cases, newly constructed buildings with considerable size, or existing buildings that increase capacity by expanding the building footprint are required to have signal strength of -95 dBm or better in designated critical areas in order to receive a certificate of occupancy. Examples of such areas include: Emergency Command Centers, Fire Pump Rooms, electrical and mechanical closets, and stairwells.

Guardian UHF is UL2524 2nd Edition listed and meets the code for NFPA 72/1221 and IFC 510. In addition, the Guardian UHF features a UL50/NEMA Type 4 rated amplifier housing.

The Guardian UHF comes equipped with integrated alarming compatibility, local configuration via USB and Ethernet enabled remote monitoring. TowerIQ also provides an industry-leading 3-year warranty.

1.2 Package Contents

Your BDA box contains the following items:

- Guardian UHF bi-directional amplifier with UL50/NEMA Type 4 rated housing and mounting kit
- Integrated alarm cable (5 ft)

1.3 Additional Items Needed

The Guardian UHF 5W needs the following additional components for a complete install:

- Two External antennas (directional Yagi)
- Multiple Inside antennas (omnidirectional domes and/or directional panels)
- Cable splitter for inside antennas
- Sufficient lengths of ultra-low loss interior/exterior cable, 50-ohm
- Lightning surge arrestor
- Grounded surge suppressor for DC power supply
- Ethernet cable

Note: Some component options are listed in Section 1.5 below. Not all accessories are listed.

1.4 Key Features & Benefits

- Improves coverage for Public Safety Band cellular network frequencies: UL: 450-512MHz | DL: 450-512MHz.
- 90 dB gain, 5-watt, Simplex system
- UL2524 2nd Edition Certified
- Meets the code for NFPA 72/1221 and IFC 510
- UL50/NEMA Type 4 rated amplifier housing.
- Supplementary Ethernet port with built-in TowerIQ Sentry™ remote monitoring software
- Integrated alarming
- Connects to UL2524 Listed UPS for external battery backup power supply
- Automatic gain control (AGC) and Oscillation Detection
- 24VDC power options
- Independently adjustable frequency attenuation for uplink and downlink (Reduce gain in -1 dBm increments)
- Industry leading 3-year warranty

1.5 Optional Accessories

TowerIQ provides many optional features and accessories for the Guardian UHF amplifier. Note, some component options are listed in table below. Not all accessories are listed.

See your TowerIQ salesperson for all compatible part numbers.

Exterior Antenna Options
Directional Wide Band 50Ω Yagi Antenna (450-512 MHz); N-Female connectors; 8dBi gain.
Directional Wide Band 50Ω Yagi Antenna (450-470 MHz, 470-490 MHz and 490-512 MHz); N-Female connectors; 12dBi gain.
Note: The sum of antenna gain (dBi) and cable loss (dB) cannot exceed 9.
Interior Antenna Options
Omni-directional Wide Band 50 Ω Dome Antennas (450 -512MHz); N-Female connectors; 1dBi gain.
Directional Wide Band 50 Ω Panel Antennas (450 -512 MHz); N-Female connectors; 4dBi gain.
Note: The sum of antenna gain (dBi) and cable loss (dB) cannot exceed 0.
Ultra Low-Loss Coaxial Cable
3996129 Trilogy 1/2-inch conductor air dielectric cable
Splitters, Couplers & Accessories
Couplers (450-512 MHz)
Splitters (450-512 MHz)
TQ-LP Lightning Protector
5 dB; 10 dB; 20 dB RF Attenuator
TQ-Mount-Pole: L Bracket mount with U bolt hardware for donor antenna mount to J-bar
TQ-Mount-JBar: Steel 1 inch J-Bar mount for donor antenna. Antenna mount not included

1.6 How it Works

The Guardian UHF is a bi-directional amplifier that amplifies downlink signals that reach a building from the nearest municipal Public Safety radio tower, and uplink signals from handheld radios inside the building going back to the tower. This compensates for weak reception caused by distance, topography, and the building structure itself. The BDA receives the signal from an outside antenna (donor), amplifies that signal, and then rebroadcasts it via antenna(s) inside the building, where it can then be picked up by handheld radios inside. In the reverse direction, interior antennas also pick up signals coming from radios, where they are amplified by the BDA, and then passed to the outdoor (donor) antenna for rebroadcast back to the tower.

1.7 A Word About Safety

Follow all safety precautions in this manual. This information is designed to prevent personal injury, equipment malfunction, and/or radio interference. You are responsible for ensuring a safe installation.

Your installation may require working in high locations such as roofs and/or ladders. Follow applicable safety regulations and best practices to avoid falling. Take care not to drop objects from any high area. Cordon off ground areas directly below the section of roof you are working on, or below your ladder whenever possible.

In addition, as a qualified installer, you are responsible for knowing and following all applicable codes and regulations and for obtaining all required permits and inspections.

Always use appropriate personal protective equipment such as goggles, gloves, hard hat, etc. as needed, and as required. Failure to exercise caution when working in high areas could cause a fall and personal injury.



RF SAFETY WARNING: ANY ANTENNA USED WITH THIS DEVICE MUST BE LOCATED AT LEAST 8 INCHES FROM ALL PERSONS.



CHANGES OR MODIFICATIONS NOT EXPRESSLY APPROVED BY TOWERIQ COULD VOID THE USER'S AUTHORITY TO OPERATE THE EQUIPMENT.

1.8 Warning Notices:

Caution: notices may also be used in this manual to draw attention to matters that do not constitute a risk of causing damage to the equipment but where there is a possibility of seriously impairing its performance, e.g. by mishandling or gross maladjustment. Warnings and Cautions within the main text do not incorporate labels and may be in shortened form.

These draw the attention of personnel to hazards that may cause damage to the equipment. An example of use is the case of static electricity hazard.

Caution: Risk of explosion if battery is replaced by an incorrect type. Dispose used batteries according to the instructions.

Disconnection of the 2 RF connectors may cause damage to the equipment when power is on. The application antenna and RF cable are not provided. The sum of antenna gain (dBi) and cable loss (dB) should not exceed 0dBi for inside antenna and 9dBi for outside antenna, and the installation must ensure that the shortest distance to a human is a minimum of 1.151 meter.

Important: Unauthorized antenna cables and/or coupling devices may not be used. Changes or modifications not expressly approved by the TowerIQ could void the user's authority to operate the equipment.

Use of unauthorized antennas, cables, and/or coupling devices not conforming with ERP/EIRP and/or indoor only restrictions is prohibited. Home/ personal use are prohibited.

Note: If the insertion loss of the outside cable exceeds 3dB, the VSWR alarm will be affected.

CHAPTER 2: BDA INTERFACE & CONNECTIONS

2.1 Guardian UHF 5W BDA Interface Overview

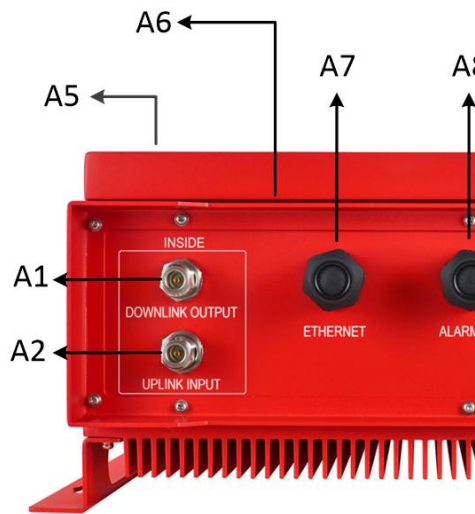

Interface	Type	Description
A1	DOWNLINK OUTPUT	N Female; To serving (Interior) antenna.
A2	UPLINK INPUT	N Female; To serving (Interior) antenna.
A3	DOWNLINK INPUT	N Female; To Donnor (Exterior) antenna pointing to the tower.
A4	UPLINK OUTPUT	N Female; To Donnor (Exterior) antenna pointing to the tower.
A5	ALARM LEDs	Indicate an alarm condition
A6	USB	Used to initialize the network connection devices
A7	ETHERNET	Cat5e Standard Ethernet Cable Device
A8	ALARM I/O	Connect to the building fire alarm control unit (FACP).
A9	DC INPUT	Connect UPS, voltage range is 18.5-29V; DC power is the secondary power supply, and secondary power (DC input) source shall be UL2524 listed.
A10		This hole is reserved.
A11	GROUNDING LUG	Grounding lug

2.2 ON/OFF Switch



An ON/OFF switch is located on the inside panel upper right hand side which is accessed by opening the door to the BDA enclosure. The ON/OFF switch is used to cut off the connection between RF module and both the DC input and the power supply output.

2.3 RF Interfaces (A1, A2, A3 and A4)



A1, A2— N-type Female for OUTSIDE cable and donor antenna



A3, A4 — N-type Female for INSIDE cable and Serving antenna

2.4 Power Wiring for AC and DC Power for 24V Battery Backup Power Supply

The wiring terminal block for AC and 24V Battery Backup is located on the inside panel lower right hand side which is accessed by opening the door to the BDA enclosure.



DC+	Battery positive input (Red)
DC-	Battery negative input (Black)
<i>Wire Gauge: 14 to 22 AWG</i>	

Note: 1/4" spacing is to be maintained between power limited and non-power limited Circuits.

2.5 GUI interface

GUI interfaces are used for firmware updates of the BDA and are not normally utilized.
GUI1 is for the Sentry Board firmware update and GUI2 is for the RF board firmware update.

2.6 Fire Alarm I/O Interface

The I/O interface terminal block is located on the inside panel lower middle which is accessed by opening the door to the BDA enclosure.

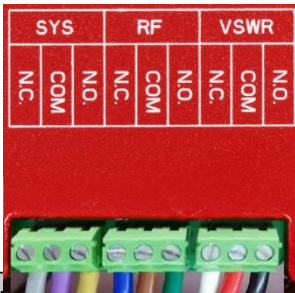
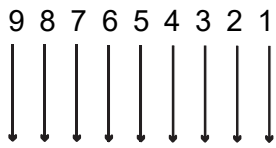

Number	Definition	Wire Color on Cable
1	VSWR Alert (N.O.)	Black
2	VSWR Alert (COM)	Red
3	VSWR Alert (N.C.)	White
4	Oscillation Detected Alert (N.O.)	Green
5	Oscillation Detected Alert (COM)	Brown
6	Oscillation Detected Alert (N.C.)	Blue
7	Component Alert (N.O.)	Yellow
8	Component Alert (COM)	Purple
9	Component Alert (N.C.)	Gray

Note: these connections need to be made to Power Limited sources.

2.7 VSWR Alert Trigger Criteria

The VSWR Alert is triggered under one (or more) of the following conditions:

- VSWR Alarm caused by outdoor (donor) VSWR ratio exceeding threshold value required to prevent damage to BDA.
 - High VSWR can be caused by removing the donor antenna from the outdoor connection to the BDA.
 - High VSWR can be caused by defective connectors or metal touching or near the donor antenna.

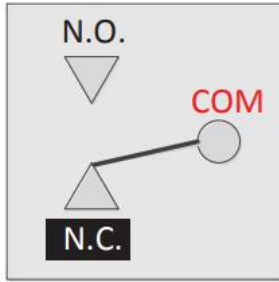

Relay Shown In Non-Alarm Condition for N.C.

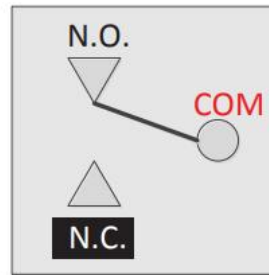

Alarm Condition for N.C.

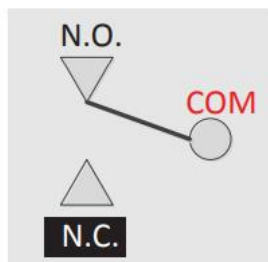

Relay Shown In Non-Alarm Condition for N.O.

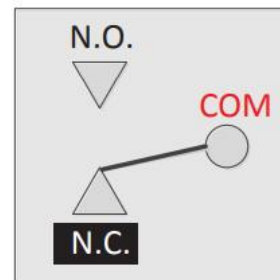

Alarm Condition for N.O.

2.8 Oscillation Detected Alert Trigger Criteria

The Oscillation Detected Alert is triggered under one (or more) of the following conditions:

- The isolation between outside antenna and inside antenna is insufficient. The recommended isolation can be calculated using the formula: $BDA\ Gain + 15dB$. Consult your local AHJ for any recommendations or requirements.

The condition that caused the Oscillation condition must be corrected and the BDA power cycled to restore correct operation.

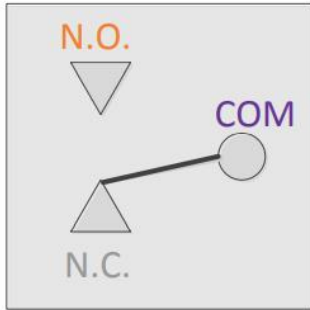

Relay Shown In Non-Alarm Condition for N.C.

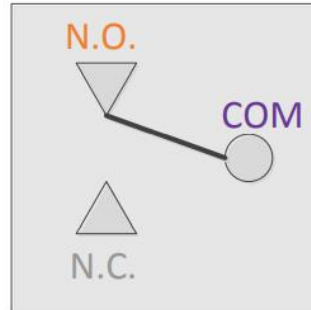

Alarm Condition for N.C.

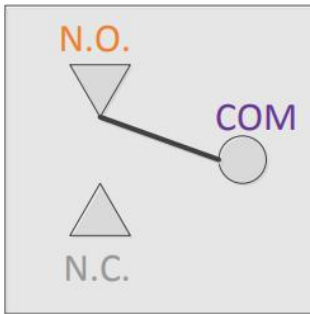

Relay Shown In Non-Alarm Condition for N.O.

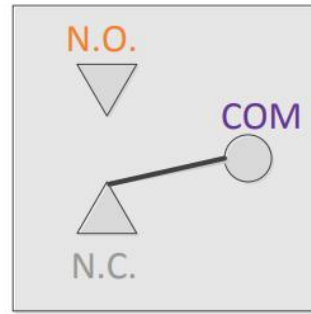

Alarm Condition for N.O.

2.9 Component Alert Trigger Criteria

The Component Alert is triggered under the following:

- RF Power amplifier current is abnormal

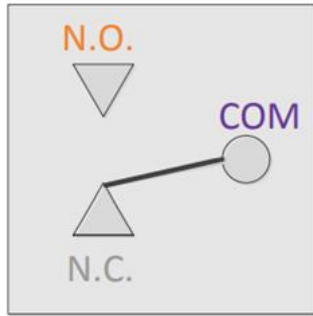

Relay Shown In Non-Alarm Condition for N.C.

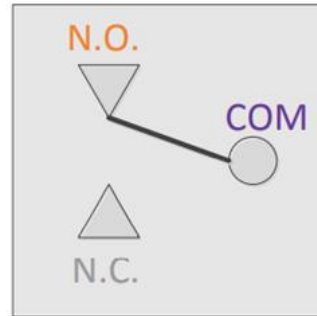

Alarm Condition for N.C.

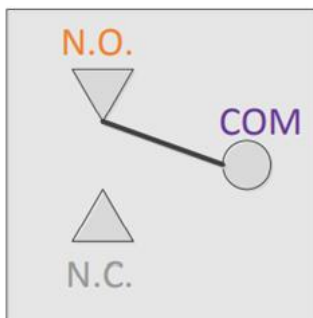

Relay Shown In Non-Alarm Condition for N.O.

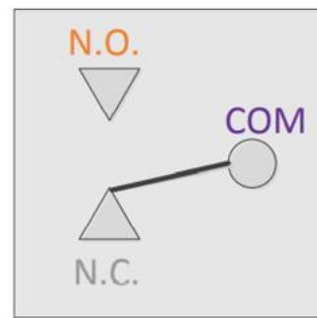

Alarm Condition for N.O.

2.10 Load Restrictions

Alarm Dry Contact Output Restrictions: 1 A at 30 VDC (Resistive)

Note: these connections need to be made to Power Limited sources.

2.11 Ethernet Interface

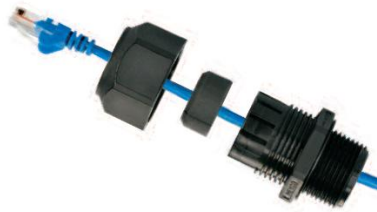

Ethernet Connector

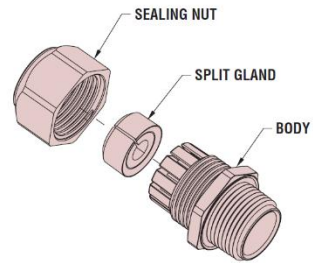

Ethernet Connector Assembly Drawing

2.12 USB Interface

- 1 The USB connector is located inside the Guardian UHF unit enclosure at the lower left side of the interior panel as shown below.
- 2 The UL50/NEMA Type 4 enclosure door must be open to gain access to the USB port. The USB interface is used to configure the Guardian UHF unit for correct operation using the Guardian Sentry Microsoft Windows based configuration application and a computer with Microsoft Windows OS installed (Windows 10 or 11 is recommended). Note that Windows Surface tablets are NOT supported due to device driver incompatibility).
- 3 Be sure to unplug the USB cable and close and lock the enclosure door after the Guardian UHF unit configuration is completed.

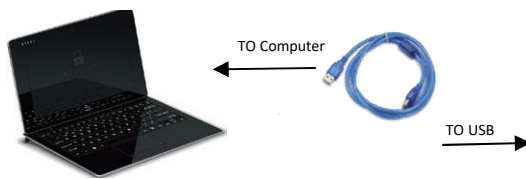

3.1 Alarm LEDs

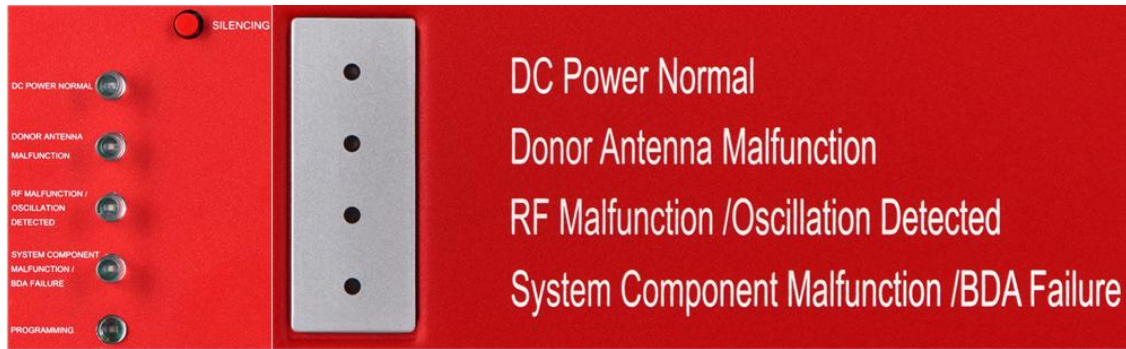

INSIDE BDA ALARM INTERFACE OUTSIDE TYPE 4 ALARM INTERFACE

		Status	Description
1	DC Power Normal	Green ON	DC Power is present and working properly
		OFF	DC Power is not present
2	Donor Antenna Malfunction	Red ON	Connection to the donor antenna has been interrupted or is not present. Possible bad connector or cable termination.
		OFF	No Alarm Present
3	RF Malfunction /Oscillation Detected	Red ON	RF emitting device can't function because oscillation is happening, often caused by indoor and outdoor antennas being too close.
		OFF	No Alarm Present
4	System Component Malfunction /BDA Failure	Red ON	System component failure. Overpower condition has occurred.
		Off	No Alarm Present
		Flashing	The sentry board is being reprogrammed.
5	Programming	Red ON	BDA is being programmed
		OFF	Programming not in progress
6	Silencing (button)	If the trouble is triggered, press this button to silence the audible alarm. It needs to be pressed once every 22 hours when it's in silencing position or the booster will sound.	

Note: Dedicated building annunciation shall provide to indicate DC loss or low DC secondary power source. Secondary power source annunciator needs to be installed adjacent to the BDA system and the BDA shall be located in close proximity to the FACP. Please refer to the wiring instruction provided by the secondary power source.

CHAPTER 3: PLANNING THE INSTALLATION

3.1 Installation Overview

Typically, a BDA installation follows these steps:

1. Choose a mounting location for the exterior antenna. The recommended Yagi directional antenna is installed and pointed directly at the AHJ designated radio tower (line of sight) and away from the interior of the building on which it is mounted. The antenna is typically mounted on the wall or roof of the side of the building with the strongest signal. A grounded lightning protector is required between the exterior antenna and the BDA.
2. Next, choose the mounting location of the interior antenna(s), being sure to take isolation requirements into account. Long, narrow spaces benefit most from directional flat-panel antennas, while more square spaces benefit more from omnidirectional dome antennas.
3. Choose where to mount the BDA. This should be in a secure indoor location near a grounded power source.
4. Map the cabling route between the exterior antenna and the BDA and between the BDA and interior antennas.
5. Proceed with a 'soft installation' connecting components without securing their placement until testing can be completed.
6. Power on the BDA and perform configuration and testing explained in Chapter 5.
7. Complete installation by securing the placement of the BDA, antennas and other components,

Important Installation Safety Precautions:

- The exterior antenna must not be co-located or operating in conjunction with any other antenna.
- Always use a properly installed TowerIQ lightning protector between the exterior antenna and the BDA.
- Always power off the BDA before working on the roof of the building, or anywhere in close proximity to the outdoor antenna.
- Comply with all antenna isolation requirements to prevent signal oscillation.



CAUTION: FAILURE TO PROPERLY INSTALL A LIGHTNING PROTECTOR CAN RESULT IN DAMAGE TO THE BDA, ANTENNAS, AND WIRING.



CAUTION: SIGNAL OSCILLATION CAN CAUSE RADIO INTERFERENCE WITH RADIO TOWERS AND RESULT IN CIVIL AND/OR CRIMINAL PENALTIES.

3.2 Exterior Antenna Overview

The Yagi antenna receives and transmits signals over a focused area. It must be aimed directly (line of sight) toward the radio tower that provides the strongest signal to the building. The exterior antenna and mast (if any) must be mounted in a location that meets all of the following criteria:



- Best signal strength.
- Not co-located with other antennas or used in conjunction with other antennas.
- Away from all power lines.
- At least 6 ft. from lightning rod antennas.

- At least 8 in. from any person.

These distances are general guidelines only. Refer to the applicable building and electrical codes in your area to determine specific local requirements.

3.3 Interior Antenna Overview

You may use any combination of omnidirectional (dome) and/or directional (flat panel) interior antennas to obtain balanced signal strength throughout the structure.

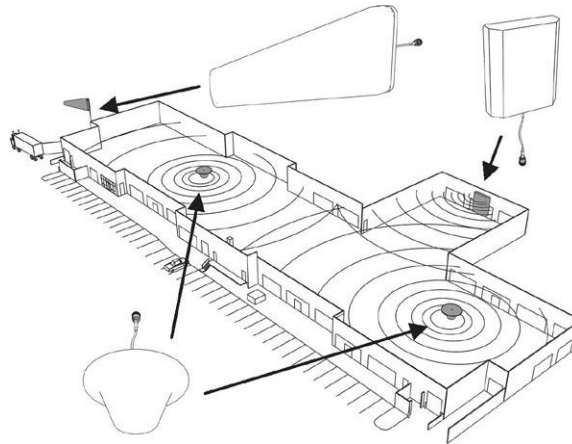

Dome antennas provide 360-degree hemispherical coverage suitable for mostly square areas, while flat panel antennas provide a focused zone of coverage suitable for long narrow areas. The example above uses two dome antennas and one panel antenna to provide full coverage.

Keep in mind that floor structures in multistory buildings can cause significant signal loss, which means that you may need to install interior antennas on more than one floor. Here is an example of a multistory installation:

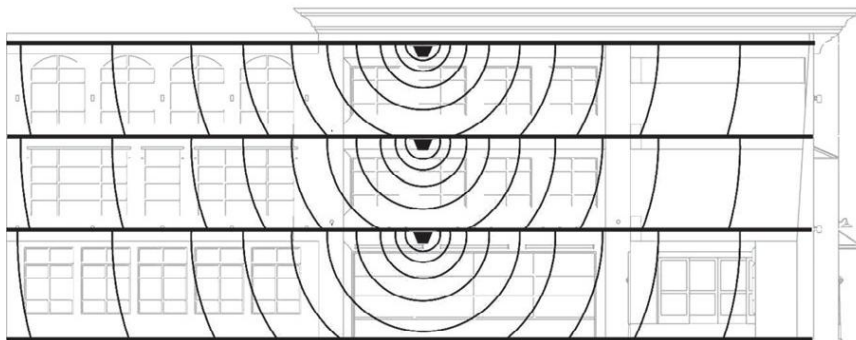

Note: You may not need antennas on every floor of a multistory building, depending on factors such as building material, BDA gain, etc.

3.4 Antenna Separation

Proper antenna separation prevents signal oscillation (feedback) that can interfere with the radio tower. Separation is measured in a straight line from the exterior antenna to the closest interior antenna. The closest allowable distance depends on a number of factors, such as BDA gain level, building material, etc. Recommended separation distances are:

Amplifier gain	Min. separation (ad)
40 dB	5'-6'
45 dB	15'-20'
50 dB	50'
55 dB	60'
65 dB	75-80'
70 dB	100'
75 dB	100'-120'
80 dB	120'-180'

Vertical separation is more important than horizontal separation. If you are unable to obtain the required separation horizontally, try raising the exterior antenna. You may also try reducing the BDA gain as described in Chapter 5 of this manual.

Antenna Safety Precautions:

You can mix and match dome and directional antennas as needed to obtain proper coverage throughout the building or area where you need to boost the signal. If you use a Yagi exterior antenna, you should normally aim it away from all interior antennas, regardless of separation, to prevent oscillation.

Antenna Aiming

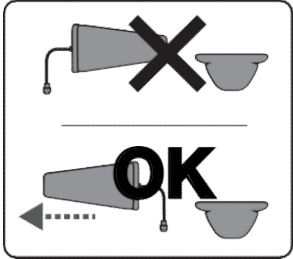

CAUTION: SIGNAL OSCILLATION CAN CAUSE RADIO INTERFERENCE WITH RADIO TOWERS AND RESULT INCIVIL AND/OR CRIMINAL PENALTIES.

3.5 BDA Location

Select an indoor location for the BDA that meets the following criteria:

- Indoor dry.
- Ambient air temperature is 25°C.
- Away from tightly enclosed or overly hot spaces.
- Power and warning lights are easily visible.
- Shortest possible cable runs to all antennas.

3.6 Accessories

The final step in the planning process is to make sure you have all of the necessary accessories to complete the installation. You will need all of the items listed in Chapter 1 of this manual plus some or all of the following:

- Cable clips: Use these to secure the cables to interior and exterior walls/ceilings.
- Appropriately rated sealant/caulking to waterproof exterior cable entry points.
- Hand and/or power tools as needed to complete the installation.
- Personal Equipment (PPE): Use all PPE required by local codes and/or best practices to help ensure personal safety during installation.



**CAUTION: YOU ARE RESPONSIBLE FOR ENSURING THAT THE
INSTALLATION MEETS ALL APPLICABLE CODES.**

Note: You may need to obtain a permit from your local building department to install the BDA and antennas. Check your local building and/or electrical codes.

3.7 Need Help?

If you need help planning your installation, contact a qualified installer, the reseller who supplied you with the BDA, or TowerIQ:

Call: 844-626-7638, 7 a.m. to 5 p.m. PST, Monday – Friday
Email: cs-guardian@tower-iq.com

CHAPTER 4: INSTALLATION

4.1 Soft Installation

Perform a “soft” installation of all components to test signal coverage and oscillation before making the installation permanent. Avoid making holes or other permanent attachments during this phase. Refer to Chapter 5 for configuration and testing instructions. Proceed with final installation once configuration and testing are complete.

4.2 Exterior Antenna

Mount the exterior antenna in the location you selected during planning. Follow all of the instructions included with the antenna to ensure that your installation is done properly. Here are a few reminders and essential steps:

- A Yagi antenna is mounted horizontally with drip hole facing down and aimed at the desired radio tower (line of sight).
- Mount the antenna.
- Connect a length of cable to the antenna and hand-tighten.
- Run the cable along the planned route.
- Install a properly grounded TQ-LP lightning protector. The donor antenna needs lightening protection per NFPA.
- Seal any exterior cable entry points on building exterior with caulking or sealant.



WARNING: DO NOT TOUCH ANY LIVE ELECTRICAL WIRES OR ALLOW THE ANTENNA OR CABLING TO TOUCH ANY LIVE ELECTRICAL WIRES.



CAUTION: AVOID AIMING A YAGI ANTENNA TOWARD ANY INTERIOR ANTENNA.

4.3 Interior Antennas

Mount the interior antenna(s) in the location(s) you selected when planning. Follow all instructions included with the antenna(s) to ensure the installation(s) are done properly.

Here are a few reminders and essential steps:

- Dome antennas are mounted on the ceiling as close to the center of the desired coverage area as possible, domed(convex) side pointing down.
- Flat panel antennas should be wall-mounted as close as possible to the center of the wall, or at one end of long narrow space.
- Mount the antenna.
- Connect a length of cable to the antenna and tighten until hand-tight.
- If you are installing multiple antennas, run the cable to the splitter location and connect the cable to one of the outputs on the splitter.
- Connect another length of cable to the input side of the splitter (if used) and run this cable to the BDA location.
- It is important to keep the cable runs equal or use taps to ensure a harmonious install.



CAUTION: VERIFY THAT ALL INTERIOR ANTENNAS MEET THESE PARATION REQUIREMENTS DESCRIBED IN THE PREVIOUS CHAPTER, AND THAT NO ANTENNA IS AIMED TOWARD THE EXTERIOR ANTENNA.



CAUTION: DO NOT CONNECT AN INTERIOR ANTENNA TO THE SPLITTER INPUT.

4.4 Mounting the BDA

Mount the Guardian UHF 5W as follows:

- Verify that the selected location meets all criteria described in the previous chapter.
- Mount a 24 inch x 24 inch x 3/4 inch thick sheet of plywood on top of sheetrock, secured into wall studs where the Type 4 housing is to be placed. The plywood should be flush against wall.
- Once the plywood is secure, attach the Type 4 housing to the plywood base using the screws provided. In most installations, the housing will be oriented, so the I/O ports are facing down.
- Connect the outdoor antenna cable to the signal booster connector port marked OUTSIDE and tighten the connection.
- Connect the indoor antenna cable to the signal booster connector port marked INSIDE and tighten the connection.



CAUTION: DO NOT POWER ON THE BDA UNTIL INSTRUCTED TO DO SO.



CAUTION: NEVER POWER ON THE BDA WHEN ANY ANTENNAS ARE DISCONNECTED AS THIS COULD DAMAGE THE BDA.

CHAPTER 5: CONFIGURATION & TESTING

5.1 Powering on the BDA

1. Make sure the exterior and interior antenna cables are firmly connected to their corresponding ports on the Type 4 enclosure.
2. Verify that the green Power light is illuminated.
3. When the BDA is turned on, the frequency band lights will flash red and green for approximately 2 seconds.



CAUTION: ONLY USE THE POWER SUPPLY INCLUDED WITH THE BDA. USE OF ANOTHER POWER SUPPLY COULD DAMAGE THE BDA AND/OR POWER SUPPLY.



CAUTION: DO NOT PROCEED BEYOND THIS POINT UNTIL THE BDA IS POWERED ON AND NO RED WARNING LIGHTS ARE ILLUMINATED.

CHAPTER 6: MAINTENANCE AND TROUBLESHOOTING

6.1 Frequency Band LED Conditions

This section will help you interpret the LED indicators on your Guardian UHF 5W. But first, here are a few configuration and testing points to keep in mind:

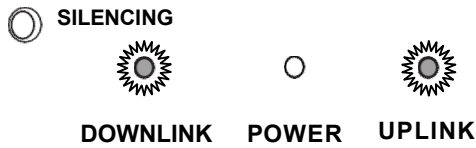

- If the control light for a specific frequency band is flashing red, try increasing the antenna separation between the inside and outside antennas as much as possible first, then restarting the booster.
- Attenuation greater than 30 dB made by the booster's software will cause the affected band to shut off and display a solid red led.

6.2 LED Conditions

LED INDICATIONS

LED Color	LED Condition	Resolution
GREEN	ON	Normal operation.
GREEN	FLASHING	Normal operation. The Automatic Gain Control (AGC) is self-adjusting.
RED	FLASHING	Indicates Oscillation
RED	SOLID	RF link is off

Refer to your Sentry Monitoring Software for more information about LED codes. Meanwhile, if you have any questions during setup, please reach out to our U.S.-based support technicians:

Call: 844-626-7638

Email: cs-guardian@tower-iq.com.

6.3 System Maintenance

No user maintainable components within this system. In the event of any system malfunction, please contact a licensed installer.

Caution: De-Energize Unit Prior to Servicing.

6.4 Testing & Troubleshooting

Once the booster is powered on (and no Warning lights are on), assess the signal in locations of needed signal improvement. Refine the antenna locations and/or gain levels as needed, then complete the permanent installation when you are confident the system will perform well.

A few tips and some perspective:

- It's not realistic to expect full reception everywhere in the building.
- As a general rule, increasing gain by 6dB doubles the coverage distance of the interior antennas. Start at the lowest gain and increase gradually as needed.
- If one or more red Warning lights comes on, it indicates there is oscillation in that band and adjustments are needed.
- If you can't get the coverage reasonably well-balanced, you may need to install an additional interior antenna and/or a different type of interior antenna and/or relocate interior antennas.

CHAPTER 7: SENTRY CONFIGURATION & MONITORING

7.1 Sentry Software Introduction

TowerIQ's Sentry is a revolutionary advancement in signal-booster management. It aids in the installation, optimization, and ongoing management of your Guardian UHF 5W BDA. It provides installers with tools for seamless system configurations, and it helps pinpoint malfunctions due to unforeseen changes in the amplifier landscape, such as new towers or repeater systems. Sentry also notifies

installers or end users about various parameters via email. Features include:

- Quick notification about booster changes and over-power situations.
- Allows offsite monitoring related to BDA performance, such as uplink/downlink power, outside signal strength or frequency band.status (On/Off).
- Helps optimize installations by monitoring and identifying the strongest signal strength available.

7.2 Software Installation

To install and configure the server, follow these steps:

- Get the TowerIQ Sentry software from your device supplier, or download the Windows software here:
<https://toweriq.nyc/products/guardian-series>



- Install the software using the steps outlined below.
- Configure the server to a static IP or public IP address.
- In order to function on the network correctly, the server and the device must be (a) on the same Local Area Network, or (b) the server must be the front end to the device.
- Use appropriate security software for safe and reliable operation when connected to a network.
- All device and user information will be stored on the computer.

Double-click ClientUserSetup to start the installation, which takes you to Welcome screen.

Note: To avoid install glitches, we recommend you close all other Windows programs running on your computer before proceeding.

After you have shut down other programs, click Next, which will take you to the User Information screen shown below. This where you'll enter user information. It may be you as the installer, or you may be setting this up for someone else who will be monitoring the system on an ongoing basis.

7.3 Hardware Installation

Once the Sentry software is installed, you can proceed to connect and configure the Guardian UHF 5W BDA. To install the hardware, first complete the following steps:

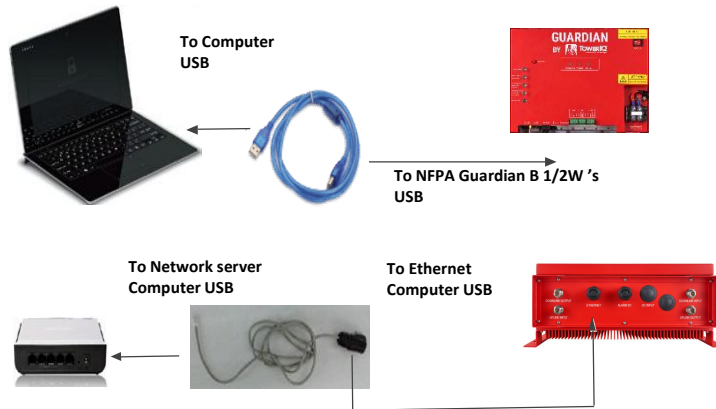

- **USB Connection:** Use a USB cable (supplied with your BDA) to connect your computer directly to the Guardian UHF 5W USB port. The USB connection on the Guardian UHF 5W is accessible by opening the UL50/NEMA Type 4 enclosure. The port is located in the lower left side of the unit interior panel inside the enclosure, as shown above .
- **Ethernet Connection:** Plug the Ethernet cable into the yellow-capped socket on the bottom of the UL50/NEMA Type 4 enclosure, labeled Ethernet. The other end of the Ethernet cable goes to the network server or network switch on the LAN. Ethernet is a supplementary circuit.

Once the connections are made, power on the Guardian UHF 5W BDA.

Note: The Ethernet cable length should not exceed 30 meters(98.5ft)

Start the Sentry client application by clicking on the shortcut that resulted from installing the software. You will see the screen below:

7.4 User Registration

You'll need to register an account. Connect your computer to the network. A secure LAN connection is required because it will allow the computer to verify the device on the network. Fill in the User Registration form and choose a user name, password, email and user phone. Once completed, click the Register button.



Click Register and you'll see the following screen, prompting you to enter the local Server IP address.

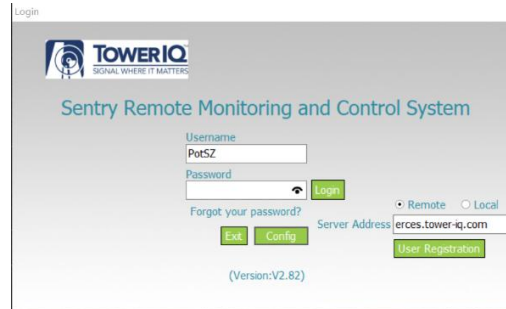

Enter TowerIQ's server IP: 12.232.138.150 or domain name erces.tower-iq.com

Enter a User Name, Password, E-mail, and User Phone in the fields provided. Then click Register to proceed. You will the Login screen again, as shown in the next screen.



In the fields provided, enter the Username and Password that you registered on the system. This will enable you to proceed to device configuration, as explained in the steps below:

7.6 Device Registration

Connect the device to the networked client computer with a USB cable as described in the previous section. Make sure the server is also linked to the computer. Select a serial port and click Open, as shown in the Add Booster screen below.

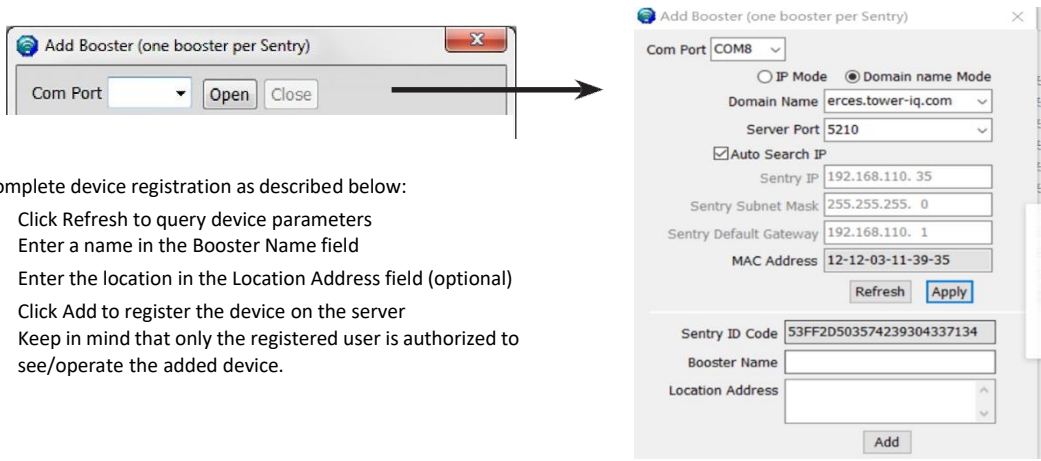

Complete device registration as described below:

- Click Refresh to query device parameters
- Enter a name in the Booster Name field
- Enter the location in the Location Address field (optional)
- Click Add to register the device on the server
- Keep in mind that only the registered user is authorized to see/operate the added device.

7.5 Device Configuration

Using the same screen as before, configure the device according to the steps below.

- Select a serial port and click Open.
- Click Refresh to query device parameters.
- Click on the drop-down menu and select a server IP address and port number to make sure the device can be connected to the server.
- Dynamic IP is available by checking Auto Search IP function, OR...enter IP parameters manually, if the device needs a static IP.
- Click Apply to finish the configuration.

Modify Booster Information. To modify the booster information, right click to access a pop-up menu with the following additional options. Select Edit Booster Info to proceed.

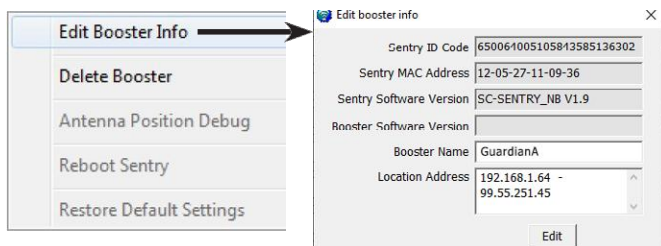

Delete Booster. To delete a booster, right click on the summary screen again to access a pop-up menu with additional options, and then select Delete Booster.

You will see a confirmation screen as shown below. Click Yes to proceed.



Password and E-mail Management (Supplementary): In the Tools pull-down menu, you can change your account information, including your password, or the E-mail address for status reports. Roll over the Accounts heading and click on Modify Password/E-mail to access this feature.

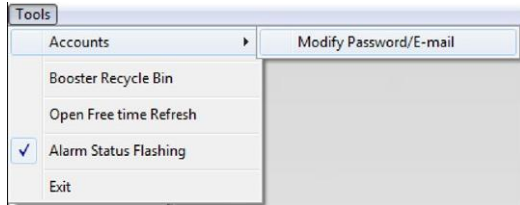

To modify your password, type in the requested information shown below and click on Modify.

 A screenshot of a form for modifying user information. The form is divided into two columns. The left column contains: 'User Name' (with 'demo' entered), 'Old Password', 'New Password', and 'Confirm Password'. The right column contains: 'E-mail' (with 'support@surecall.com' entered), 'User Phone' (with '888-365-6283' entered), 'Purchased Extension' (with an unchecked checkbox), and 'Purchased from'. There are 'Modify' buttons at the bottom of each column.

To change the e-mail address where alerts go, enter a new e-mail as shown above and click on Modify.



NOTE: IF YOU FORGET YOUR PASSWORD, CLICK FORGOT MYPASSWORD ON THE LOGIN PAGE.

THE PASSWORD WILL BE SENT TO YOUR E-MAIL ADDRESS.

7.6 Sentry Operation

Digital filter configuration

Sentry Remote Monitoring and Control System(V2.90)

Tools

Type: Guardian UHF Class A Sentry ID Code: 23FF6D50140533353955034

Digital filter Configuration RF State

Channel	Downlink Frequency	Uplink Frequency	Switch	Uplink ATT	DownLink ATT	Uplink Pin	Downlink Pin	Bandwidth
1	451.000000 MHz	456.000000 MHz	ON	0 dB	0 dB	-59 dBm	-51 dBm	12.5K
2	452.000000 MHz	457.000000 MHz	ON	0 dB	0 dB	-59 dBm	-51 dBm	12.5K
3	453.000000 MHz	458.000000 MHz	ON	0 dB	0 dB	-59 dBm	-51 dBm	12.5K

ALL OFF

Squelch activation enable: OFF

Show channels: 3

Uplink squelch activation level: -85 dBm

Downlink squelch activation level: -85 dBm

Bandwidth: 12.5K

Refresh Set

1. Downlink Frequency and Uplink Frequency: This column is used to input the frequency of the channel.
For example, enter 451 in the Downlink frequency box of channel 1 and enter 456 in the Uplink frequency box, and click the **Set** button. The downlink channel will then work at 451MHz; The uplink channel will work at 456MHz.
2. SWITCH: Use the switch column to open or close a channel.
OFF closes the channel;
ALL OFF closes all the channels;
ON opens the channel
3. UPLINK ATT / DOWNLINK ATT: These columns are used to lower the gain of a single channel. Enter a positive value in the range of 1-25.
4. UPLINK PIN / DOWNLINK PIN: These columns show the input power of the uplink and downlink channels. This parameter can only be queried.
5. BANDWIDTH COLUMN: The bandwidth column is used to display the bandwidth of a particular frequency channel from 12.5K, 25K, and 75K.
6. Bandwidth Dropdown box:
This is used to set the bandwidth for a particular channel. The frequency bandwidth can be set to 12.5K, 25K, 75K.
7. **Set** button applies changes you've made within the window.

8. Squelch activation enable Dropdown box:

ON enables the Squelch, and then fill in the squelch level in the range of -90~-80dBm.

OFF disenables the squelch.

Setting the Uplink or downlink attenuation on this page between 1 and 30 will simultaneously set the equivalent value for all uplink or downlink channels.

Once updates are complete on this screen, click the **Set** button to apply changes.

Sentry Remote Monitoring and Control System(V2.90)

Tools

Type: Guardian UHF Class A Sentry ID Code: 23FF6D50140533353955034

Digital filter Configuration RF State

Band	Channel	Attenuation	Automatic Gain Control Attenuation	Gain	RF Output Power	Outside Signal Strength	Uplink/ Downlink Status	Band On/Off	Over Power	Oscillation	Manual Shut Off
UHF	Uplink 450-512M	<input type="text" value="0"/> dB	<input type="text" value="0"/> dB	<input type="text" value="85"/> dB	<input type="text" value="-6"/> dBm		● Active	<input type="button" value="ON"/>	● Normal	● Normal	● Normal
	Downlink 450-512M	<input type="text" value="0"/> dB	<input type="text" value="0"/> dB	<input type="text" value="90"/> dB	<input type="text" value="19"/> dBm	<input type="text" value="-71"/> dBm	● ON	<input type="button" value="ON"/>	● Normal	● Normal	● Normal

Component Status ● Normal Outdoor Antenna ● Normal VSWR

ISOLATION TEST

The donor antenna and server antenna isolation for uplink is dB

The donor antenna and server antenna isolation for downlink is dB

Sentry Software Version Booster Version

Downlink DIF MCU Version Downlink DIF FPGA Version

Uplink DIF MCU Version Uplink DIF FPGA Version

From the dashboard above you can manually adjust the attenuation dB to resolve problems. You can also turn off individual bands.

CHAPTER 8: SPECIFICATIONS

Electrical			
	Unit of measure		
Frequency Range, Uplink	MHz	450-512	
Frequency Range, Downlink	MHz	450-512	
Operation Bandwidth	MHz	0.7/2/3.5/5/24	
Number of Sub-Channel		4	
Total Maximum Output Power, Uplink	dBm	27±1	
Total Maximum Output Power, Downlink	dBm	36±1	
Average System Gain	dB	90±2	
Gain Adjustment Range (1dB step)	dB	30	
Pass Band Ripple, p-p	dB	≤10	
Noise Figure	dB	≤5	
System Group Delay	usec	6	
Intermodulation	dBm	≤-13	
Spurious	9 kHz to 1 GHz	dBm	FCC Compliance
	1 GHz to 12.75 GHz	dBm	FCC Compliance
Absolute Maximum RF Input Power	dBm	10	
Impedance:	ohm	50Ω	
FCC ID:		2AXVJGUARD-UHFB	
Certifications		FCC Part 90	
Alarm Dry Contact Output Restrictions		1 A at 30 VDC (Resistive) These connections need to be made to power limited Sources	
Mechanical Specifications			
Dimensions (H x W x D):	in (mm)	21.2 x 17.2 x 8.0 in (550 x 436 x 203 mm)	
Weight (Booster only):	lbs (kg)	45.9 lbs (20.8 kg)	
Weight (Box as shipped):	lbs	53 lbs	
Power Supply	DC	24 V @4A	
Power Consumption	W	90	
Enclosure Cooling		Convection	
RF Connectors		N-Female	
Operating Temperature	°F (°C)	-4 to +122 (-20 to +50)	
Operating Humidity		95%	
Environmental Class:		Type 4	

CHAPTER 9: SAFETY AND COMPLIANCE

FCC Compliance

This is a Class B booster. The product has been tested and found to comply with the Booster Requirements per FCC Part 90.

Part 90 Signal Boosters THIS IS A 90.219 CLASS B DEVICE

WARNING: This is NOT a CONSUMER device. It is designed for installation by FCC LICENSEES and QUALIFIED INSTALLERS. You MUST have an FCC LICENSE or the express consent of an FCC Licensee to operate this device. You MUST register Class B signal boosters (as defined in 47 CFR 90.219) online at www.fcc.gov/signal-boosters/registration. Unauthorized use may result in significant forfeiture penalties, including penalties in excess of \$100,000 for each continuing violation.

15.105: This equipment has been tested and found to comply with the limits for a Class B digital device, pursuant to part 15 of the FCC Rules. These limits are designed to provide reasonable protection against harmful interference in a residential installation. This equipment generates, uses and can radiate radio frequency energy and, if not installed and used in accordance with the instructions, may cause harmful interference to radio communications. However, there is no guarantee that interference will not occur in a particular installation. If this equipment does cause harmful interference to radio or television reception, which can be determined by turning the equipment off and on, the user is encouraged to try to correct the interference by one or more of the following measures:

- Reorient or relocate the receiving antenna.
- Increase the separation between the equipment and receiver.
- Connect the equipment into an outlet on a circuit different from that to which the receiver is connected.
- Consult the dealer or an experienced radio/TV technician for help.



WARNING: CHANGES OR MODIFICATIONS NOT EXPRESSLY APPROVED BY TOWERIQ COULD VOID THE USER'S AUTHORITY TO OPERATE THE EQUIPMENT.

CHAPTER 10: WARRANTY

For questions regarding your warranty, contact a TowerIQ representative at 844-626-7638 or email cs-guardian@tower-iq.com.

10.1 Warranty Periods

TowerIQ products are covered under a three-year product warranty from the date of purchase. This protects the customer from any defects or problems the product may have that are solely the fault of TowerIQ. Incorrect installation or misuse will void this warranty. Upon the return of a defective product, TowerIQ will issue the customer a working replacement. All returned packages should contain all products distributed.

10.2 Three-Year Product Warranty

TowerIQ warrants its products for three years from the date of purchase against defects in workmanship and/or materials. Specifications are subject to change.

Products returned by customers must be in their original, un-modified condition, shipped in the original or protective packaging with proof-of-purchase documentation enclosed, and a Return Merchandise Authorization (RMA) number printed clearly on the outside of the shipping container.

Buyers may obtain an RMA number for warranty returns by calling the TowerIQ Return Department toll-free at 1-888-365-6283. Any returns received by TowerIQ without an RMA number clearly printed on the outside of the shipping container will be returned to sender. In order to receive full credit for signal boosters, all accessories originally included in the signal booster box must be returned with the signal booster. (The Buyer does not need to include accessories sold in addition to the signal booster, such as antennas or cables.)

This warranty does not apply to any product determined by TowerIQ to have been subjected to misuse, abuse, neglect, or mishandling that alters or damages the product's physical or electronic properties.

TowerIQ warrants to the Buyer that each of its products, when shipped, will be free from defects in material and workmanship, and will perform in full accordance with applicable specifications. The limit of liability under this warranty is, at TowerIQ's option, to repair or replace any product or part thereof which was purchased up to THREE YEARS prior, as determined by examination by TowerIQ, prove defective in material and/or workmanship. Warranty returns must first be authorized in writing by TowerIQ. Disassembly of any TowerIQ product by anyone other than an authorized representative of TowerIQ voids this warranty in its entirety. TowerIQ reserves the right to make changes in any of its products without incurring any obligation to make the same changes on previously delivered products.

As a condition to the warranties provided for herein, the Buyer will prepay the shipping charges for all products returned to TowerIQ for repair, and TowerIQ will pay the return shipping with the exception of products returned from outside the United States, in which case the Buyer will pay the shipping charges.

The Buyer will pay the cost of inspecting and testing any goods returned under the warranty or otherwise, which are found to meet the applicable specifications or which are not defective or not covered by this warranty.

Products sold by TowerIQ shall not be considered defective or non-conforming to the Buyer's order if they satisfactorily fulfill the performance requirements that were published in the product specification literature, or in accordance with samples provided by TowerIQ. This warranty shall not apply to any products or parts thereof which have been subject to accident, negligence, alteration, abuse, or misuse. TowerIQ makes no warranty whatsoever in respect to accessories or parts not supplied by it.

10.3 Limitations of Warranty, Damages and Liability

EXCEPT AS EXPRESSLY SET FORTH HEREIN, THERE ARE NO WARRANTIES, CONDITIONS, GUARANTEES, OR REPRESENTATIONS AS TO MERCHANTABILITY, FITNESS FOR A PARTICULAR PURPOSE, OR OTHER WARRANTIES, CONDITIONS, GUARANTEES, OR REPRESENTATIONS, WHETHER EXPRESSED OR IMPLIED, IN LAW OR IN FACT, ORAL OR IN WRITING.

TOWERIQ AGGREGATE LIABILITY IN DAMAGES OR OTHERWISE SHALL NOT EXCEED THE PAYMENT, IF ANY, RECEIVED BY TOWERIQ, INC. FOR THE UNIT OF PRODUCT OR SERVICE FURNISHED OR TO BE FURNISHED, AS THE CASE MAY BE, WHICH IS THE SUBJECT OF CLAIM OR DISPUTE. IN NO EVENT SHALL TOWERIQ BE LIABLE FOR INCIDENTAL, CONSEQUENTIAL, OR SPECIAL DAMAGES, HOWSOEVER CAUSED.

All matters regarding this warranty shall be interpreted in accordance with the laws of the State of Missouri, and any controversy that cannot be settled directly shall be settled by arbitration in Missouri in accordance with the rules then prevailing of the American Arbitration Association, and judgment upon the award rendered may be entered in any court having jurisdiction thereof. If one or more provisions provided herein are held to be invalid or unenforceable under applicable law, then such provision shall be ineffective and excluded to the extent of such invalidity or unenforceability without affecting in any way the remaining provisions hereof.

WARNING: E911 location information may not be provided or may be inaccurate for calls served BY USING THIS DEVICE.

1609 Park 370 Place,
Hazelwood, MO 63042
844-626-7638
www.toweriq.nyc

TowerIQ has made a good faith effort to ensure the accuracy of the information in this document and disclaims the implied warranties of merchantability and fitness for a particular purpose and makes no express warranties, except as may be stated in its written agreement with and for its customers. TowerIQ shall not be held liable to anyone for any indirect, special or consequential damages due to omissions or errors. The information and specifications in this document are subject to change without notice.

© 2024. All Rights Reserved. All trademarks and registered trademarks are the property of their respective owners.

TowerIQ, Inc
1609 Park 370 Place,
Hazelwood, MO 63042, USA
844-626-7638 | www.toweriq.nyc