

# TowerIQ GuardianB™

User and Installation Guide

Class B Public Safety BDA for First Responders



For technical support:  
Email: [guardian@tower-iq.com](mailto:guardian@tower-iq.com) | Call: 844-626-7638  
Available Monday – Friday, 7am – 5pm PST

Activate your warranty at [www.toweriq.nyc](http://www.toweriq.nyc)

06.16.2021



## FCC NOTICE

The TowerIQ Guardian B signal booster is a 90.219 Class B Device. Under Section 90.219(d)(5) of the Commission's rules, all Part 90 Class A signal booster installations must be registered with the FCC.

NOTE: This equipment has been tested and found to comply with the limits for a Class B digital device, pursuant to part 15 of the FCC Rules. These limits are designed to provide reasonable protection against harmful interference in a commercial environment. This equipment generates, uses and can radiate radio frequency energy and, if not installed and used in accordance with the instructions, may cause harmful interference to radio communications. Operation of this equipment in a residential area is likely to cause harmful interference in which the user will be required to correct the interference at his own expense.

Filing Registrations. To register a Part 90 Class A signal booster, go to the Part 90 Signal Booster Registration and Discovery page at [www.fcc.gov/signal-boosters/registration](http://www.fcc.gov/signal-boosters/registration). Enter an FCC Registration Number (FRN) and Password in the upper-right corner of the screen. Then click on "LOGIN."

On the Signal Booster Information page, enter either (1) latitude and longitude (in decimal degrees) of the booster location and click on the "Get Address Info" button; or (2) the booster, city, and state, and click on the "Get Lat/Long button. The registration tool will provide a map of the booster location to verify the location is correct. Next, check the box(es) for the frequencies within the operating range of the signal booster and enter at least one call sign associated with the booster. Then enter the filer's Company Information (Company Name, Company Attention, Address, Email registration, enter Signature Information (Title, Name), and click "Submit." The system will generate a confirmation, including a booster ID number, which you may print for your records. Each booster must be submitted separately. Using the links in the upper-right corner of the Signal Booster Confirmation page, you can "Add a Booster," "View Your Boosters" or "Log out."

Accessing Registrations. Each registration will be available to the public on the same day it is filed with the Commission. Registrations may be accessed at: [www.fcc.gov/signal-boosters/registration](http://www.fcc.gov/signal-boosters/registration). Click on "View All Boosters" from the Part 90 Signal Booster Registration and Discovery page. The registrations can be searched and sorted by booster ID number, name of the filer, city, county, state, zip code, latitude/longitude, or call sign.

For further information please contact the FCC Licensing Support Hotline at (877) 480-3201 or submit an online help request at <https://esupport.fcc.gov/onlinequest.htm>. Support hours are Monday thru Friday, 8:00–6:00 p.m. Eastern Time, except for Federal holidays.

Applicant's name: TowerIQ, Inc.  
Address: 13723 Riverport Drive  
C/O Potter Electric Signal Company  
Saint Louis, MO 63043  
Contact person: [michaelm@pottersignal.com](mailto:michaelm@pottersignal.com); Call: 314-683-2218

FCC Contact information is <https://signalboosters.fcc.gov/signal-boosters/Federal>  
Communications Commission  
45 L Street NE  
Washington, DC 20554  
Phone: 1-888-225-5322  
TTY: 1-888-835-5322

# TABLE OF CONTENTS

FCC NOTICE.....	4
TABLE OF CONTENTS.....	5
CHAPTER 1: INTRODUCTION & OVERVIEW.....	6
1.1 Product Overview.....	6
1.2 Package Contents.....	6
1.3 Additional Items Needed.....	6
1.4 Key Features & Benefits.....	6
1.5 Optional Accessories.....	7
1.6 How it Works.....	8
1.7 A Word About Safety.....	8
1.8 Warning Notices.....	8
CHAPTER 2: BDA INTERFACE & CONNECTIONS.....	9
2.1 Guardian B BDA Interface Overview.....	9
2.2 RF Interfaces.....	10
2.3 Power Wiring DC Power for 24-30V UPS/Battery Backup.....	11
2.4 AC Power 110V.....	11
2.5 Alarm I/O Interface.....	11
2.6 VSWR Alert Trigger Criteria.....	12
2.7 Component Alert Trigger Criteria.....	12
2.7 VSWR Alarm Trigger Criteria.....	14
2.8 Load Restrictions.....	14
2.9 Ethernet Interface.....	15
2.10 USB Interface.....	15
2.11 Alarm LEDs.....	16
CHAPTER 3: PLANNING THE INSTALLATION.....	17
3.1 Installation Overview.....	17
3.2 Exterior Antenna Overview.....	17
3.3 Interior Antenna Overview.....	18
3.4 Antenna Separation.....	19
3.5 BDA Location.....	20
3.6 Accessories.....	20
3.7 Need Help?.....	20
CHAPTER 4: INSTALLATION.....	21
4.1 Soft Installation.....	21
4.2 Exterior Antenna.....	21
4.3 Interior Antennas.....	21
4.4 Mounting the BDA.....	22
CHAPTER 5: CONFIGURATION & TESTING.....	23
5.1 Powering on the BDA.....	23
5.2 DIP Switch Configuration.....	23
CHAPTER 6: TESTING AND TROUBLESHOOTING.....	26
6.1 Band LED Conditions.....	26
6.2 LED Conditions.....	26
6.3 Testing & Troubleshooting.....	26
CHAPTER 7: SENTRY CONFIGURATION & MONITORING.....	27
7.1 Sentry Software Introduction.....	27
7.2 Software Installation.....	27
7.3 Hardware Installation.....	28
7.4 User Registration.....	29
7.5 Device Registration.....	30
7.6 Device Configuration.....	30
7.7 Sentry Operation.....	32
CHAPTER 8: SPECIFICATIONS.....	33
CHAPTER 9: SAFETY AND COMPLIANCE.....	33
9.1 FCC Compliance.....	33
CHAPTER 10: WARRANTY.....	35
10.1 Warranty Periods.....	35
10.2 Three-Year Product Warranty.....	35
10.3 Limitations of Warranty, Damages and Liability.....	35

## CHAPTER 1: INTRODUCTION & OVERVIEW

### 1.1 Product Overview

Guardian B is a 2-watt, bi-directional amplifier with a maximum gain of 80 dB supporting both the 700 and 800 MHz Public Safety frequency bands.

In the majority of cases, newly constructed buildings with considerable size, or existing buildings that increase capacity by expanding the building footprint are required to have signal strength of -95 dBm or better in designated critical areas – Emergency Command Centers, Fire Pump Rooms, stairwells, standpipe, cabinets, etc. – in order to receive a certificate of occupancy. Guardian B meets the code for NFPA 72/1221 and IFC 510 and features a NEMA-4 rated amplifier housing.

Additionally, the Guardian B comes equipped with integrated alarming compatibility, UPS and Ethernet enabled remote monitoring. TowerIQ provides an industry leading 3-year warranty – extendable to 5 years.

### 1.2 Package Contents

Your BDA box contains the following items:

- Guardian B bi-directional amplifier with NEMA-4 rated housing and mounting kit
- Integrated alarm cable (5 ft)
- Integrated AC power cable (4 ft)
- Integrated DC power cable (4 ft 9 in)

### 1.3 Additional Items Needed

The Guardian B needs the following additional components for a complete install:

- One External antenna <sup>a</sup> (directional Yagi)
- Multiple Inside antennas <sup>b</sup> (omnidirectional domes and/or directional panels)
- Cable splitter for inside antennas <sup>c</sup>
- Sufficient lengths of ultra-low loss interior/exterior cable, 50-ohm <sup>d</sup>
- Lightning surge arrestor
- Grounded surge suppressor for DC power supply
- Ethernet cable

Note: Some component options are listed in table below. Not all accessories are listed.

### 1.4 Key Features & Benefits

- Improves coverage for Public Safety Band cellular network frequencies: UL: 788-798, 779-805, 806-816 | DL: 758-768, 769-775, 851-861
- 80 dB gain, 2-watt system
- Meets the code for NFPA 72/1221 and IFC 510
- NEMA-4 rated amplifier housing. No additional NEMA enclosure needed
- Ethernet port with built-in TowerIQ Sentry™ remote monitoring hardware
- Integrated alarming
- UPS for external battery backup
- Automatic gain control (AGC) and Oscillation Detection
- Energy-saving operation allows bands to remain dormant when not in use
- A/C 110V or D/C 24- 30V power option
- Independently adjustable frequency attenuation for uplink and downlink (Reduce gain in -1 dBm increments)
- Industry leading 3-year warranty

## 1.5 Optional Accessories

TowerIQ provides many optional features and accessories for the Guardian B amplifier. Note, some component options are listed in table below. Not all accessories are listed.

See your TowerIQ salesperson for all compatible part numbers

Outdoor Antenna Options
Directional Wide Band 50Ω Yagi Antenna (698-960 MHz); N-Female connectors; 8 dBi. Note: Must use at least 2 dB insertion loss
Note: The sum of antenna gain (dBi) and cable loss (dB) cannot exceed 6 And if the insertion loss of outside cable exceeds 4dB, the VSWR alert will be affected.
Inside Antenna Options
Omni-directional Wide Band 50 Ω Dome Antennas (698 -960 MHz); N-Female connectors; 3 dBi
Directional Wide Band 50 Ω Panel Antennas (698-960 MHz); N-Female connectors; 6 dBi. Note: Must use at least 3 dB insertion loss cable for this option
Note: The sum of antenna gain (dBi) and cable loss (dB) cannot exceed 3
Ultra Low-Loss Coaxial Cable
TQ-400 Low-Loss Coax
TQ-600 Ultra Low-Loss Coax
TQ-400 Ultra Low-Loss Coax Plenum Fire-Rated Coax
Splitters, Couplers & Accessories
Wide Band Couplers (698-2700 MHz)
Wide Band Splitters (698-2700 MHz)
TQ-LP Lightning Protector
5 dB; 10 dB; 20 dB RF Attenuator
TQ-Mount-Pole: L Bracket mount with U bolt hardware for donor antenna mount to J-bar
TQ-Mount-JBar: Steel 1 inch J-Bar mount for donor antenna. Antenna mount not included

Fire-rated plenum cable is UL-rated for plenum ceilings (UL E473791)

## 1.6 How it Works

The Guardian B amplifies signals that reach a building from the nearest radio tower, and from radios inside the building going back to the tower. This compensates for weak reception caused by distance, topography, building structure, etc. The BDA receives the signal from an outside antenna, amplifies that signal, and then rebroadcasts it via antenna(s) inside the building, where it can then be picked up by radios inside. In the reverse direction, interior antennas also pick up signals coming from radios, where they are amplified by the BDA, and then passed to the exterior antenna for rebroadcast back to the tower.

## 1.7 A Word About Safety

Follow all safety precautions in this manual. This information is designed to prevent personal injury, equipment malfunction, and/or radio interference. You are responsible for ensuring a safe installation.

Your installation may require working in high locations such as roofs and/or ladders. Follow applicable safety regulations and best practices to avoid falling. Take care not to drop objects from any high area. Cordon off ground areas directly below the section of roof you are working on, or below your ladder whenever possible.

In addition, as a qualified installer, you are responsible for knowing and following all applicable codes and regulations and for obtaining all required permits and inspections.

Always use appropriate personal protective equipment such as goggles, gloves, hard hat, etc. as needed, and as required. Failure to exercise caution when working in high areas could cause a fall and personal injury.



**RF SAFETY WARNING: ANY ANTENNA USED WITH THIS DEVICE MUST BE LOCATED AT LEAST 8 INCHES FROM ALL PERSONS.**



**CHANGES OR MODIFICATIONS NOT EXPRESSLY APPROVED BY TOWERIQ COULD VOID THE USER'S AUTHORITY TO OPERATE THE EQUIPMENT.**

## 1.8 Warning Notices:

Caution: notices may also be used in this manual to draw attention to matters that do not constitute a risk of causing damage to the equipment but where there is a possibility of seriously impairing its performance, e.g. by mishandling or gross maladjustment. Warnings and Cautions within the main text do not incorporate labels and may be in shortened form.

These draw the attention of personnel to hazards that may cause damage to the equipment. An example of use is the case of static electricity hazard.

Caution, risk of explosion if battery is replaced by an incorrect type. Dispose used batteries according to the instructions.

Disconnection of the 2 RF connectors may cause damage to the equipment when power is on. The application antenna and RF cable are not provided.

The antenna gain should not exceed 3 dBi for inside antenna and 9 dBi for outside antenna, shortest distance from human is 0.8843m

Important: Unauthorized antenna cables and/or coupling devices may not be used. Changes or modifications not expressly approved by the TowerIQ could void the user's authority to operate the equipment.

Use of unauthorized antennas, cables, and/or coupling devices not conforming with ERP/EIRP and/or indoor only restrictions is prohibited Home/ personal use are prohibited.

Note: If the insertion loss of the outside cable exceeds 3dB the VSWR alarm will be affected.



## CHAPTER 2: BDA INTERFACE & CONNECTIONS

### 2.1 Guardian B BDA Interface Overview

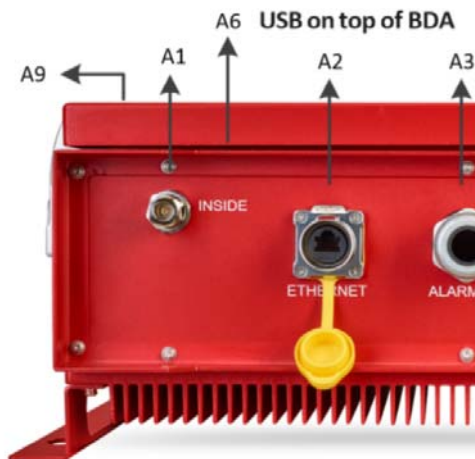

Interface	Type	Description
A1	INSIDE	N Female for INSIDE cable and antenna
A2	ETHERNET	Cat5e Standard Ethernet Cable Device
A3	ALARM1 I/O	To Fire Department Control Box
A4	POWER DC 24-30V	Connect DC, voltage between 24-30V
A5	OUTSIDE	N Female for OUTSIDE cable and antenna
A6	USB	Used to initialize the network connection devices
A7	GROUNDING LUG	Grounding lug
A8	POWER 110 VAC	Connect to 110VAC or 110V of UPS output
A9	ALARM LEDs	Indicate an alarm condition

## 2.2 RF Interfaces



A1 — N-type Female for OUTSIDE  
cable and antenna



A5 — N-type Female for INSIDE  
cable and antenna

### 2.3 Power Wiring DC Power for 24-30V UPS/Battery Backup



Battery line:  
Red: Positive  
Black: Negative

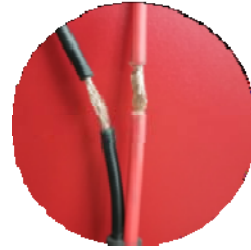

### 2.4 AC Power 110V



Green: ground  
Black: N  
White: L



### 2.5 Alarm I/O Interface

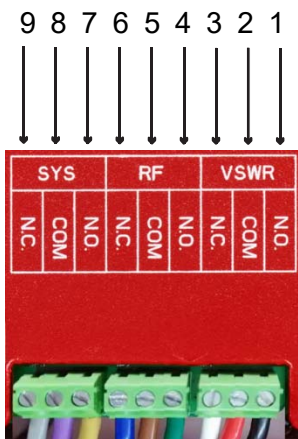

Number	Definition	Wire Color on Cable
1	VSWR Alert (N.O.)	Black
2	VSWR Alert (COM)	Red
3	VSWR Alert (N.C.)	White
4	Oscillation Detected Alert (N.O.)	Green
5	Oscillation Detected Alert (COM)	Brown
6	Oscillation Detected Alert (N.C.)	Blue
7	Component Alert (N.O.)	Yellow
8	Component Alert (COM)	Purple
9	Component Alert (N.C.)	Gray

## 2.6 VSWR Alert Trigger Criteria

The VSWR Alert is triggered under one (or more) of the following conditions:

- VSWR Alarm caused by outdoor VSWR abnormal

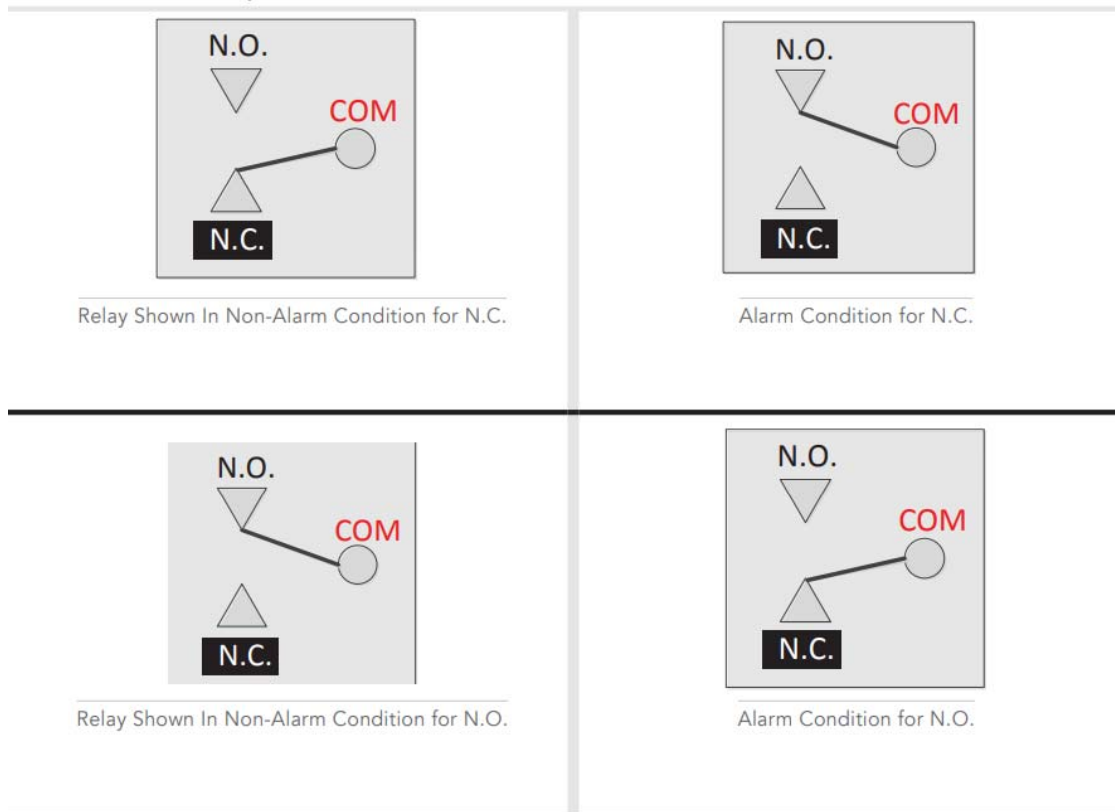

## 2.7 Oscillation Detected Alert Trigger Criteria

The Oscillation Detected Alert is triggered under one (or more) of the following conditions:

- The isolation between outside antenna and inside antenna is not enough.

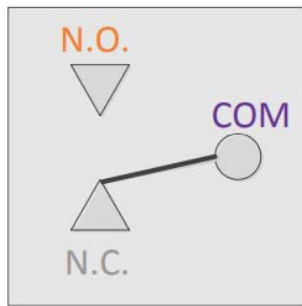

Relay Shown In Non-Alarm Condition for N.C.

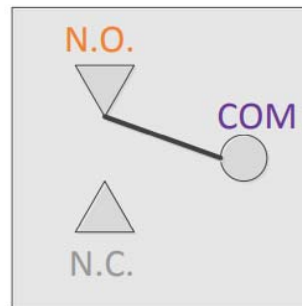

Alarm Condition for N.C.

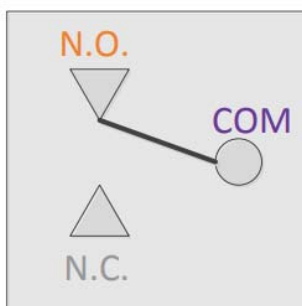

Relay Shown In Non-Alarm Condition for N.O.

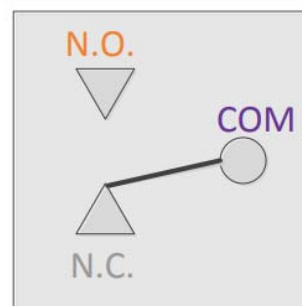

Alarm Condition for N.O.

## 2.7 Component Alert Trigger Criteria

The Component Alert is triggered under the following:

- Repeater current is abnormal

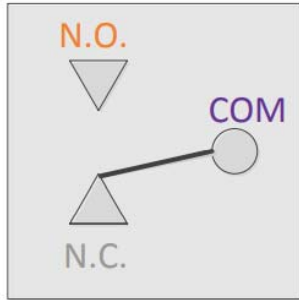

Relay Shown In Non-Alarm Condition for N.C.

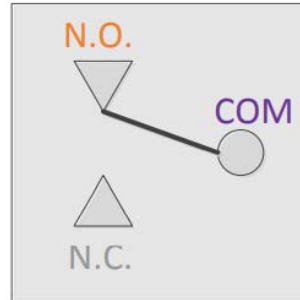

Alarm Condition for N.C.

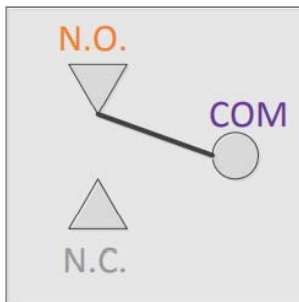

Relay Shown In Non-Alarm Condition for N.O.

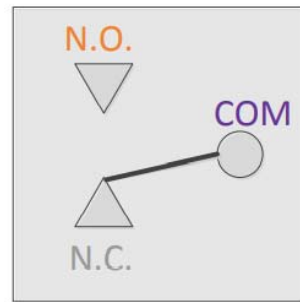

Alarm Condition for N.O.

## 2.8 Load Restrictions

Alarm Dry Contact Output Restrictions

- 1 A at 30 VDC (Resistive)
- 0.5 A at 60 VDC (Resistive)
- 0.3 A at 125 VAC (General Use)

## 2.9 Ethernet Interface



Male Connector used to transfer to internet or ethernet



Female Ethernet Port (RJ-45) on BDA

## 2.10 USB Interface

The USB connector is on top of the Guardian B unit, below the DIP switches, as shown below.

Only when initializing the network connection equipment, after initialization unplug the USB cable.

As shown, the NEMA housing must be open to gain access to this port. The interface is used to initialize network connections using a computer. Be sure to unplug the USB cable after the network initialization is completed.

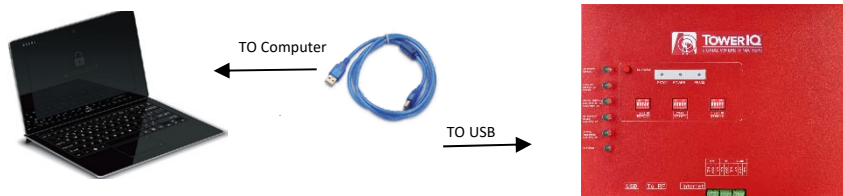

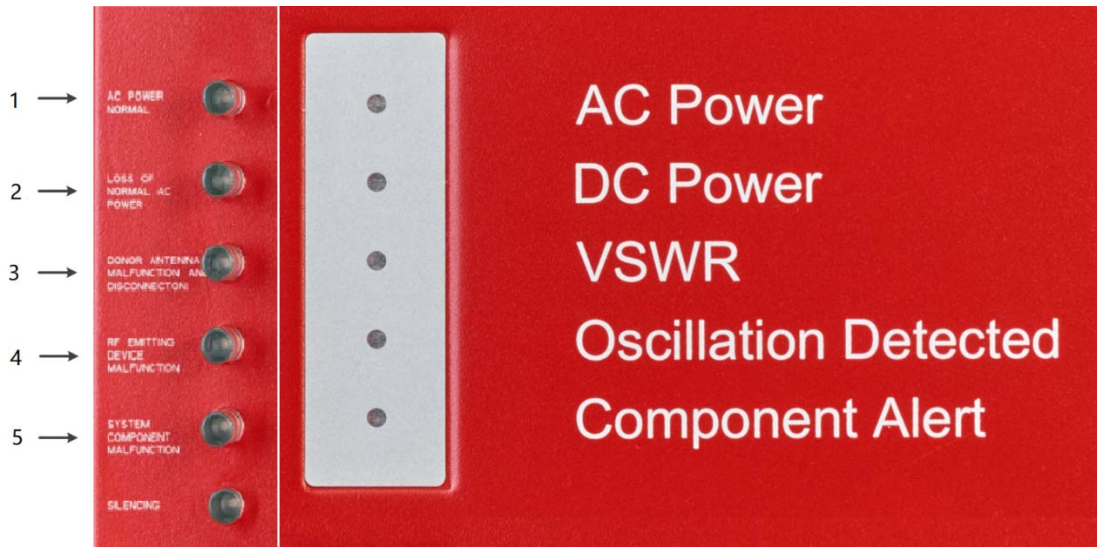

INSIDE BDA ALARM INTERFACE    OUTSIDE NEMA ALARM INTERFACE

### 2.11 Alarm LEDs

		Status	Description
1	AC Power	Green ON	AC Power is working properly
		OFF	
2	DC Power	Red ON	AC Power is not working, and BDA has switched to DC Power.
		OFF	
3	VSWR	Red ON	Connection to the donor antenna has been interrupted or is not present. Possible bad connector or cable termination.
		OFF	
4	Oscillation Detected	Red ON	RF emitting device can't function because oscillation is happening, often caused by indoor and outdoor antennas being too close.
		OFF	
5	Component Alert	Red ON	Some system components failing. Overpowering has occurred.
		Off	
6	Silencing (button)		If the alarm is triggered, press this button to silence the audible alarm. It needs to be pressed once every 22 hours when it's in silencing position or the booster will sound.



## CHAPTER 3: PLANNING THE INSTALLATION

### 3.1 Installation Overview

Typically, a BDA installation follows these steps:

1. Choose a mounting location for the exterior antenna. The recommended Yagi directional antenna is, pointed directly at the radio tower (line of sight). The antenna is typically mounted on the wall or roof of the side of the building with the strongest signal. A grounded lightning protector is required between the exterior antenna and the BDA.
2. Next, choose the mounting location of the interior antenna(s), being sure to take separation requirements into account. Long, narrow spaces benefit most from directional flat-panel antennas, while more square spaces benefit more from omnidirectional dome antennas.
3. Choose where to mount the BDA. This should be in a secure indoor location near a grounded power source.
4. Map the cabling route between the exterior antenna and the BDA and between the BDA and interior antennas.
5. Proceed with a 'soft installation' connecting components without securing their placement until testing can be completed.
6. Power on the BDA and perform configuration and testing explained in Chapter 5.
7. Complete installation by securing the placement of the BDA, antennas and other components,

Important Installation Safety Precautions:

- The exterior antenna must not be co-located or operating in conjunction with any other antenna.
- Always use a properly installed TowerIQ lightning protector between the exterior antenna and the BDA.
- Always power off the BDA before working on the roof of the building, or anywhere in close proximity to the external antenna.
- Comply with all antenna separation requirements to prevent signal oscillation.



CAUTION: FAILURE TO PROPERLY INSTALL A LIGHTNING PRO-TECTOR CAN RESULT IN DAMAGE TO THE BDA, ANTENNAS, AND WIRING.



CAUTION: SIGNAL OSCILLATION CAN CAUSE RADIO INTERFER-ENCE WITH RADIO TOWERS AND RESULT IN CIVIL AND/OR CRIMINAL PENALTIES.

### 3.2 Exterior Antenna Overview

The Yagi antenna receives and transmits signals over a focused area. It must be aimed directly (line of sight) toward the radio tower that provides the strongest signal to the building. The exterior antenna and mast (if any) must be mounted in a location that meets all of the following criteria:



- Best signal strength.
- Not co-located with other antennas or used in conjunction with other antennas.
- Away from all power lines.
- At least 6 ft. from lightning rod antennas.
- At least 8 in. from any person.

These distances are general guidelines only. Refer to the applicable building and electrical codes in your area to determine specific local requirements.

### 3.3 Interior Antenna Overview

You may use any combination of omnidirectional (dome) and/or directional (flat panel) interior antennas to obtain balanced signal strength throughout the structure.

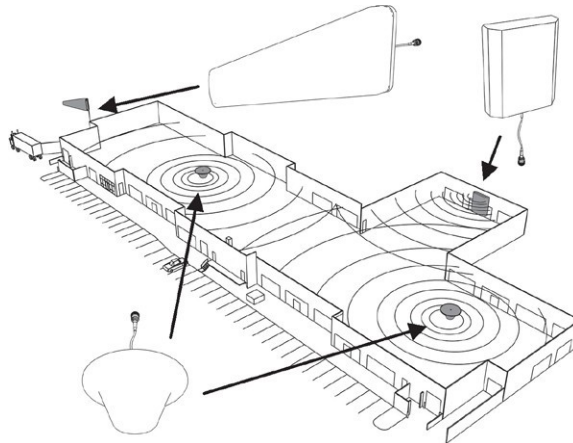

Dome antennas provide 360-degree hemispherical coverage suitable for mostly square areas, while flat panel antennas provide a focused zone of coverage suitable for long narrow areas. The example above uses two dome antennas and one panel antenna to provide full coverage.

Keep in mind that floor structures in multistory buildings can cause significant signal loss, which means that you may need to install interior antennas on more than one floor. Here is an example of a multistory installation:

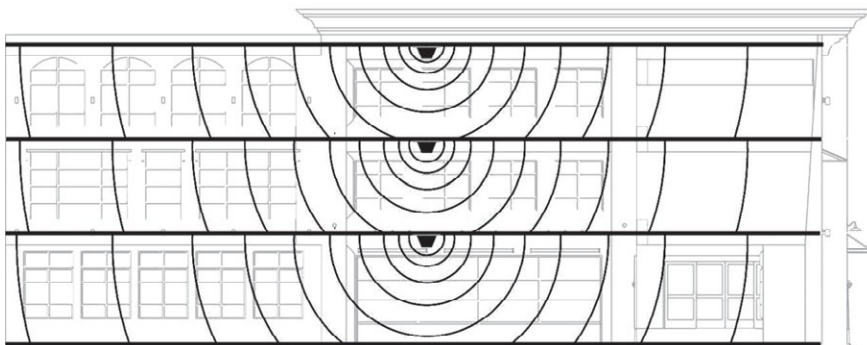

Note: You may not need antennas on every floor of a multistory building, depending on factors such as building material, BDAgain, etc.

### 3.4 Antenna Separation

Proper antenna separation prevents signal oscillation (feedback) that can interfere with the radio tower. Separation is measured in a straight line from the exterior antenna to the closest interior antenna. The closest allowable distance depends on a number of factors, such as BDA gain level, building material, etc. Recommended separation distances are:

Amplifier gain	Min. separation (ad)
40 dB	5'-6'
45 dB	15'-20'
50 dB	50'
55 dB	60'
65 dB	75-80'
70 dB	100'
75 dB	100'-120'
80 dB	120'-180'

Vertical separation is more important than horizontal separation. If you are unable to obtain the required separation horizontally, try raising the exterior antenna. You may also try reducing the BDA gain as described in Chapter 5 of this manual.

#### Antenna Safety Precautions:

You can mix and match dome and directional antennas as needed to obtain proper coverage throughout the building or area where you need to boost the signal. If you use a Yagi exterior antenna, you should normally aim it away from all interior antennas, regardless of separation, to prevent oscillation.

#### Antenna Aiming

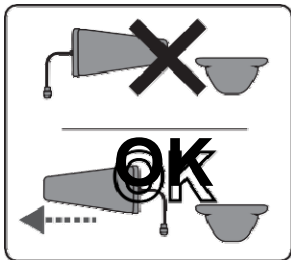

CAUTION: SIGNAL OSCILLATION CAN CAUSE RADIO INTERFERENCE WITH RADIO TOWERS AND RESULT IN CIVIL AND/OR CRIMINAL PENALTIES.

### 3.5 BDA Location

Select an indoor location for the BDA that meets the following criteria:

- Away from tightly enclosed or overly hot spaces
- Near a properly grounded 110VAC outlet
- Power and warning lights are easily visible
- Shortest possible cable runs to all antennas

### 3.6 Accessories

The final step in the planning process is to make sure you have all of the necessary accessories to complete the installation. You will need all of the items listed in Chapter 1 of this manual plus some or all of the following:

- Cable clips: Use these to secure the cables to interior and exterior walls/ceilings.
- Appropriately rated sealant/caulking to waterproof exterior cable entry points
- Hand and/or power tools as needed to complete the installation
- Personal Equipment (PPE): Use all PPE required by local codes and/or best practices to help ensure personal safety during installation.



**CAUTION: YOU ARE RESPONSIBLE FOR ENSURING THAT THE  
INSTALLATION MEETS ALL APPLICABLE CODES.**

Note: You may need to obtain a permit from your local building department to install the BDA and antennas. Check your local building and/or electrical codes.

### 3.7 Need Help?

If you need help planning your installation, contact a qualified installer, the reseller who supplied you with the BDA, or TowerIQ:

Call: 844-626-7638, 7 a.m. to 5 p.m. PST, Monday – Friday  
Email: [guardian@tower-iq.com](mailto:guardian@tower-iq.com)

## CHAPTER 4: INSTALLATION

### 4.1 Soft Installation

Perform a “soft” installation of all components to test signal coverage and oscillation before making the installation permanent. Avoid making holes or other permanent attachments during this phase. Refer to Chapter 5 for configuration and testing instructions. Proceed with final installation once configuration and testing are complete.

### 4.2 Exterior Antenna

Mount the exterior antenna in the location you selected during planning. Follow all of the instructions included with the antenna to ensure that your installation is done properly. Here are a few reminders and essential steps:

- A Yagi antenna is mounted horizontally with drip hole facing down and aimed at the desired radio tower (line of sight).
- Mount the antenna.
- Connect a length of cable to the antenna and hand-tighten.
- Run the cable along the planned route.
- Install a properly grounded TQ-LP lightning protector.
- Seal any exterior cable entry points on building exterior with caulking or sealant.

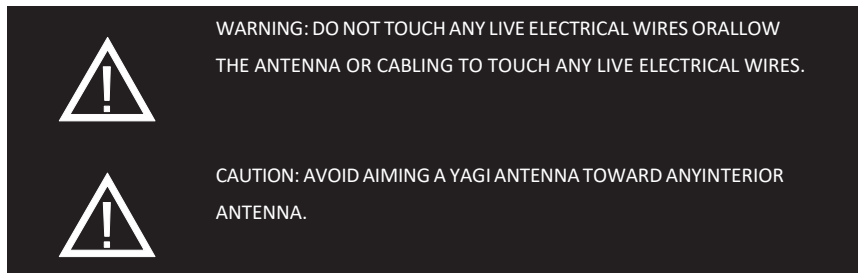

### 4.3 Interior Antennas

Mount the interior antenna(s) in the location(s) you selected when planning. Follow all instructions included with the antenna(s) to ensure the installation(s) are done properly.

Here are a few reminders and essential steps:

- Dome antennas are mounted on the ceiling as close to the center of the desired coverage area as possible, domed (convex) side pointing down.
- Flat panel antennas should be wall-mounted as close as possible to the center of the wall, or at one end of long narrow space.
- Mount the antenna.
- Connect a length of cable to the antenna and tighten until hand-tight.
- If you are installing multiple antennas, run the cable to the splitter location and connect the cable to one of the outputs on the splitter.
- Connect another length of cable to the input side of the splitter (if used) and run this cable to the BDA location.
- It is important to keep the cable runs equal or use taps to ensure a harmonious install.



CAUTION: VERIFY THAT ALL INTERIOR ANTENNAS MEET THESEPARATION REQUIREMENTS DESCRIBED IN THE PREVIOUS CHAPTER, AND THAT NO ANTENNA IS AIMED TOWARD THEEXTERIOR ANTENNA.



CAUTION: DO NOT CONNECT AN INTERIOR ANTENNA TO THESPLITTER INPUT.

#### 4.4 Mounting the BDA

Mount the Guardian B as follows:

- Verify that the selected location meets all criteria described in the previous chapter.
- Mount a 24 inch x 24 inch x 3/4 inch thick sheet of plywood on top of sheetrock, secured into wall studs where the NEMAhousing is to be placed. The plywood should be flush against wall.
- Once the plywood is secure, attach the NEMA housing to the plywood base using the screws provided. In most installations, the housing will be oriented, so the I/O ports are facing down.
- Connect the outdoor antenna cable to the signal booster connector port marked OUTSIDE and tighten the connection.
- Connect the outdoor antenna cable to the signal booster connector port marked INSIDE and tighten the connection.



CAUTION: DO NOT POWER ON THE BDA UNTIL INSTRUCTEDTO DO SO.



CAUTION: NEVER POWER ON THE BDA WHEN ANY ANTENNASARE DISCONNECTED AS THIS COULD DAMAGE THE BDA.

## CHAPTER 5: CONFIGURATION & TESTING

### 5.1 Powering on the BDA

1. Make sure the exterior and interior antenna cables are firmly connected to their corresponding ports on the NEMA-4 enclosure.
2. Plug a surge suppressor into a grounded 110VAC wall outlet.
3. Plug the AC end of the power adapter (supplied with your BDA) into the surge suppressor.
4. Plug the DC end of the power adapter into the Power port on the NEMA enclosure.
5. Verify that the green Power light is illuminated.
6. When the booster is turned on, the band lights will flash red and yellow for approximately 10 seconds.



**CAUTION: ONLY USE THE POWER SUPPLY INCLUDED WITH THE BDA. USE OF ANOTHER POWER SUPPLY COULD DAMAGE THE BDA AND/OR POWER SUPPLY.**



**CAUTION: DO NOT PROCEED BEYOND THIS POINT UNTIL THE BDA IS POWERED ON AND NO RED WARNING LIGHTS ARE ILLUMINATED.**

### 5.2 DIP Switch Configuration

By default, all DIP switches are turned in the OFF position, which provides maximum gain to all channels.

To access digital channelization, see "[Chapter 7: Sentry Configuration & Monitoring](#)" on page 26. Note that attenuation made through Sentry software is cumulative with that of the Booster's DIP switches.

BEFORE INITIAL CONFIGURATION, set booster switches with high, but not full, attenuation (as full attenuation would cause the band to shut off).

DURING CONFIGURATION, you may add gain incrementally until the signal level has improved enough to meet safety requirements.



**NOTE: TURN ALL UPLINK DIP SWITCHES TO ON AND ADJUST THEM BACK ONE STEP AT A TIME UNTIL UPLINK CONNECTIVITY IS MADE WITH THE EMERGENCY RADIO TOWER.**

Note that red flashing lights indicate the system has detected oscillation for the corresponding channel(s). The band will turn off if adjustments are not made. When adjusting booster attenuation, full power is not always the best option. The goal is to obtain a signal level throughout the building that meets safety requirements.

The following diagrams and notes explain how to interpret, and use, these switch banks. DIP switch organization

PS 700 DL DIP switches control 700 band downlink

PS UL DIP switches control 700 band and 800 band uplink

PS 800 DL DIP switches control 800 band downlink

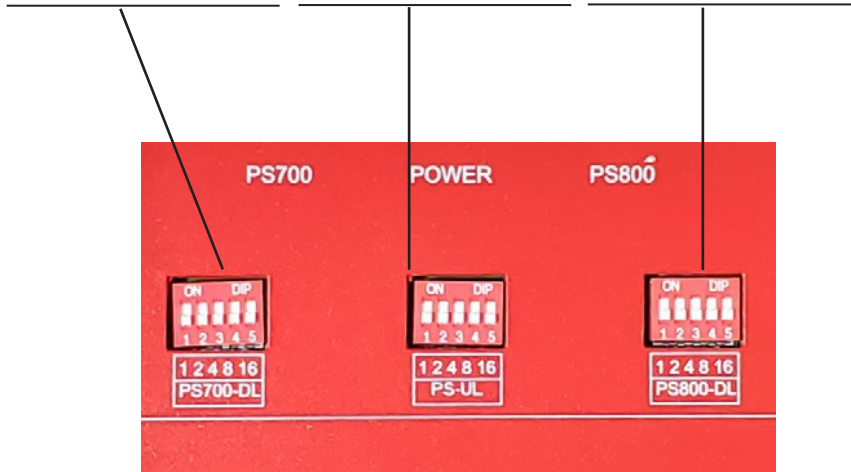

ATTENUATION THROUGH SENTRY SOFTWARE IS CUMULATIVE WITH THAT OF THE BOOSTER'S DIP SWITCHES.



Switch 1	Switch 2	Switch 3	Switch 4	Switch 5
1 dB	2 dB	4 dB	8 dB	16 dB

### DOWNLINK

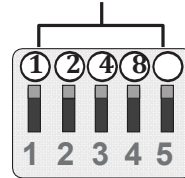

### UPLINK

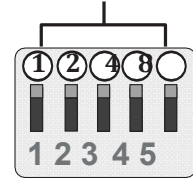

Additive combination effects:

- Switch 1 (1 dB) + Switch 2 (2 dB) = 3 dB attenuation
- Switch 1 (1 dB) + Switch 2 (2 dB) + Switch 3 (4 dB) = 7 dB attenuation
- Switch 1 (1 dB) + Switch 2 (2 dB) + Switch 3 (4 dB) + Switch 4 (8 dB) = 15 dB attenuation
- Switch 1 (1 dB) + Switch 2 (2 dB) + Switch 3 (4 dB) + Switch 4 (8 dB) + Switch 5 (16 dB) = 31 dB attenuation

practical attenuation examples:

Important Note: Turn ALL uplink attenuation dip switches to ON and adjust them back one step at a time until uplink connectivity is made with the Emergency Radio Tower.

- Turning all switches OFF = 0 dB attenuation (booster is at full gain).
- Turning ON switch #1 in a bank = 1 dB attenuation (booster maximum gain is reduced by 1 dB).
- Turning ON switches #1, 3, and 5 in a bank = 1+4+16 dB attenuation = 21 dB attenuation. For example, in an 80 dB booster, the selected channel is reduced to 59 dB (80 dB -21 dB).
- Turning ON all switches in a bank = 1+2+4+8+16 dB attenuation = 31 dB attenuation. For example, in an 80 dB booster, the selected channel is reduced to 49 dB (80 dB-31 dB).

When the BDA is powered on, the green Power Light (3) should illuminate.

- If any of the bands are oscillating, the corresponding band lights (1 and/or 2) will flash red and that band will eventually shut down if adjustments are not made.

Note: In general, the uplink and downlink DIP switches should be set identically but this is not always the case.

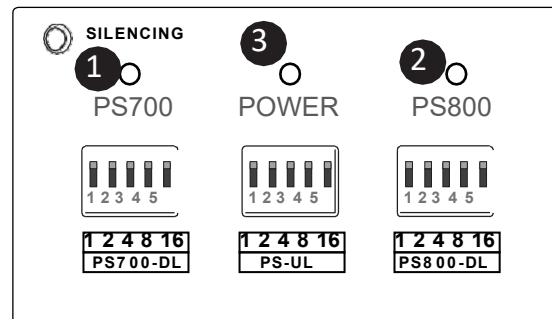

## CHAPTER 6: TESTING AND TROUBLESHOOTING

### 6.1 Band LED Conditions

This section will help you interpret the LED indicators on your Guardian A. But first, here are a few configuration and testing points to keep in mind:



- If the control light for a specific frequency band is flashing red or red-yellow, try increasing the antenna separation between the inside and outside antennas as much as possible first, then restarting the booster.
- Attenuation can be lowered to a maximum of 25 dB through sentry software and maximum of 31 dB using the booster's dip switches.
- Attenuation greater than 25 dB (either made by the booster's dip switches or cumulative adjustments of dip switches and software) will cause the affected band to shut off and display a solid red led.

### 6.2 LED Conditions

#### LED INDICATIONS

LED Color	LED Condition	Resolution
GREEN	ON	Normal operation.
GREEN	FLASHING	Normal operation. The Automatic Gain Control (AGC) is self-adjusting.
RED	FLASHING	Indicates Oscillation
RED	SOLID	RF link is off

Refer to your Sentry Monitoring Software for more information about LED codes. Meanwhile, if you have any questions during setup, please reach out to our U.S.-based support technicians:

Call: 844-626-7638

Email: [guardian@tower-iq.com](mailto:guardian@tower-iq.com)

### 6.3 Testing & Troubleshooting

Once the booster is powered on (and no Warning lights are on), assess the signal in locations of needed signal improvement. Refine the antenna locations and/or gain levels as needed, then complete the permanent installation when you are confident the system will perform well.

A few tips and some perspective:

- It's not realistic to expect full reception everywhere in the building.
- As a general rule, increasing gain by 6dB doubles the coverage distance of the interior antennas. Start at the lowest gain and increase gradually as needed.
- If one or more red Warning lights comes on, it indicates there is oscillation in that band and adjustments are needed
- If you can't get the coverage reasonably well-balanced, you may need to install an additional interior antenna and/or a different type of interior antenna and/or relocate interior antennas.

## CHAPTER 7: SENTRY CONFIGURATION & MONITORING

### 7.1 Sentry Software Introduction

TowerIQ's Sentry is a revolutionary advancement in signal-booster management. It aids in the installation, optimization, and ongoing management of your Guardian B BDA. It provides installers with tools for seamless system configurations, and it helps pinpoint malfunctions due to unforeseen changes in the amplifier landscape, such as new towers or repeater systems. Sentry also notifies installers or end users about various parameters via email. Features include:

- Quick notification about booster changes and over-power situations.
- Allows offsite monitoring and adjustments related to booster performance, such as uplink, downlink or bands.
- Helps optimize installations by monitoring and identifying the strongest signal strength available.

### 7.2 Software Installation

To install and configure the server, follow these steps:

- Get the TowerIQ Sentry software from your device supplier, or download the Windows software here: <https://toweriq.nyc/products/guardian-series>
- Install the software using the steps outlined below.
- Configure the server to a static IP or public IP address.
- In order to function on the network correctly, the server and the device must be (a) on the same Local Area Network, or (b) the server must be the front end to the device.
- Use appropriate security software for safe and reliable operation when connected to a network.
- All device and user information will be stored on the computer.

Double-click `ClientUserSetup` to start the installation, which takes you to Welcome screen.

Note: To avoid install glitches, we recommend you close all other Windows programs running on your computer before proceeding.

After you have shut down other programs, click Next, which will take you to the User Information screen shown below. This is where you'll enter user information. It may be you as the installer, or you may be setting this up for someone else who will be monitoring the system on an ongoing basis.

### 7.3 Hardware Installation

Once the Sentry software is installed, you can proceed to connect and configure the Guardian B BDA. To install the hardware, first complete the following steps:

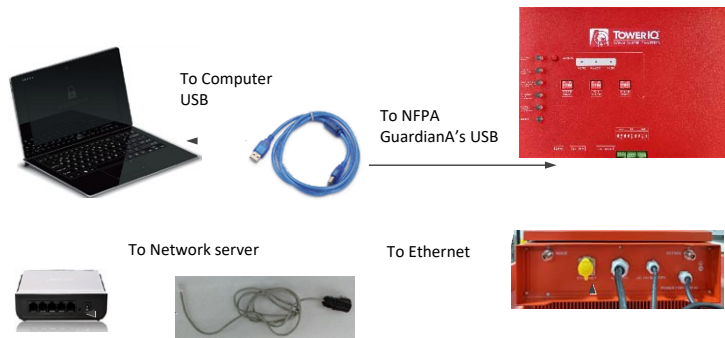

- USB Connection: Use a USB cable to connect your computer directly to the Guardian B USB port. The USB connection on the Guardian B is accessible by opening the NEMA-4 enclosure. The port is on top of the unit inside the enclosure, as shown below.
- Ethernet Connection: Plug the Ethernet cable into the yellow-capped socket on the bottom of the NEMA-4 enclosure, labeled Ethernet. The other end of the Ethernet cable goes to the network server or network switch on the LAN.

Once the connections are made, power on the Guardian B BDA.

**Register an account:** Before you finish the hardware installation, you'll first need to register an account. Connect your computer to the network where the Guardian B Ethernet connection was made. A secure LAN connection is important because it will allow the computer to "see" the Guardian B device on the network.

Start the Sentry client application by clicking on the shortcut that resulted from installing the software. You will see the screen below:

## 7.4 User Registration

You'll need to register an account. Connect your computer to the network. A secure LAN connection is important because it will allow the computer to "see" the device on the network. Fill in the User Registration form and choose a user name, password, email and user phone. Once completed, click the Register button.



Click Register and you'll see the following screen, prompting you to enter the local Server IP address.



Enter TowerIQ's server IP: 12.232.138.150 or domain name `ecres.tower-iq.com`

Enter a User Name, Password, E-mail, and User Phone in the fields provided. Then click Register to proceed. You will see the Login screen again, as shown in the next screen.



In the fields provided, enter the Username and Password that you registered on the system. This will enable you to proceed to device configuration, as explained in the steps below:

## 7.5 Device Registration

Connect the device to the networked client computer with a USB cable as described in the previous section. Make sure the server is also linked to the computer. Select a serial port and click Open, as shown in the Add Booster screen below.

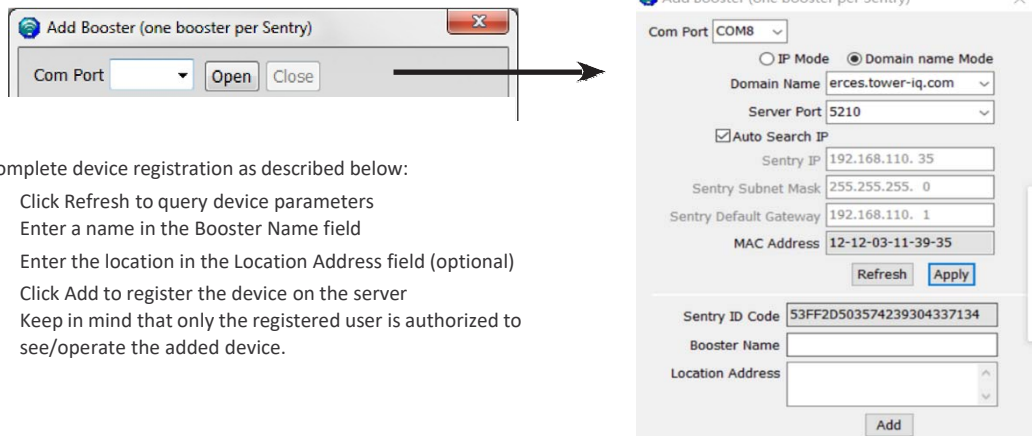

Complete device registration as described below:

- Click Refresh to query device parameters
- Enter a name in the Booster Name field
- Enter the location in the Location Address field (optional)
- Click Add to register the device on the server
- Keep in mind that only the registered user is authorized to see/operate the added device.

## 7.6 Device Configuration

Using the same screen as before, configure the device according to the steps below.

- Select a serial port and click Open.
- Click Refresh to query device parameters.
- Click on the drop-down menu and select a server IP address and port number to make sure the device can be connected to the server.
- Dynamic IP is available by checking Auto Search IP function, OR...enter IP parameters manually, if the device needs a static IP.
- Click Apply to finish the configuration.

**Modify Booster Information.** To modify the booster information, right click to access a pop-up menu with the following additional options. Select Edit Booster Info to proceed.

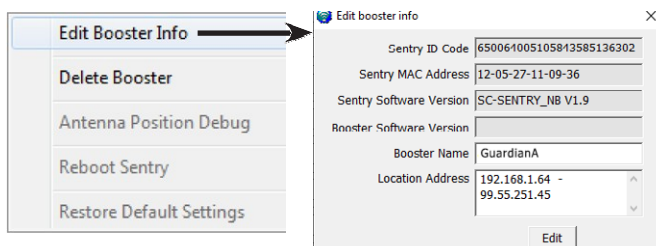

**Delete Booster.** To delete a booster, right click on the summary screen again to access a pop-up menu with additional options, and then select Delete Booster.

You will see a confirmation screen as shown below. Click Yes to proceed.

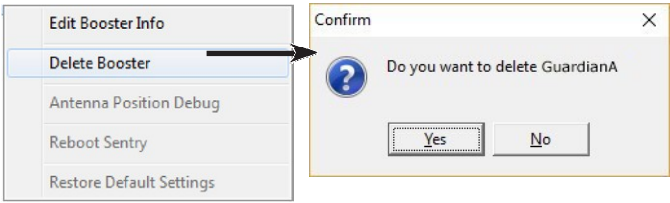

**Password and E-mail Management:** In the Tools pull-down menu, you can change your account information, including your password, or the e-mail address for status reports. Roll over the Accounts heading and click on Modify Password/E-mail to access this feature.

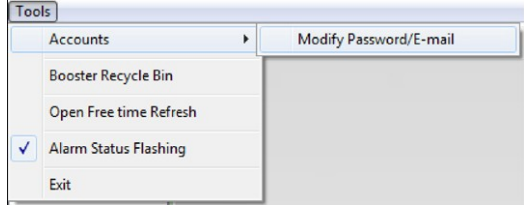

User Name	demo	E-mail	support@surecall.com
Old Password		User Phone	888-365-6283
New Password		Purchased Extension	<input type="checkbox"/>
Confirm Password		Purchased from	
<input type="button" value="Modify"/>		<input type="button" value="Modify"/>	

To modify your password, type in the requested information shown below and click on Modify.

To change the e-mail address where alerts go, enter a new e-mail as shown above and click on Modify.



NOTE: IF YOU FORGET YOUR PASSWORD, CLICK FORGOT MYPASSWORD ON THE LOGIN PAGE.

THE PASSWORD WILL BE SENT TO YOUR E-MAIL ADDRESS.

## 7.7 Sentry Operation

### RF State

- PS700 and PS800 share the same uplink RF link. Setting the Uplink Attenuation on this page between 1 and 25 will simultaneously set the equivalent value for all uplink channels for both PS700 and PS800.
- PS700 downlink Attenuation is used to attenuate the downlink gain for 700MHz band. Inputting any value between 1 and 25 will set the equivalent value for all downlink channels in this band.
- PS800 downlink Attenuation is used to attenuate the downlink gain for the 800MHz band. Inputting any value between 1 and 25 will set the equivalent value for all downlink channels in this band.

Once updates are complete on this screen, click the **Set** button to apply changes.

Type: GuardianA Name: tst1 Address:

700MHz 800MHz RF State

Band	Channel	Attenuation	Manual Attenuation	Automatic Gain Control Attenuation	Uplink/Downlink Status	Band On/Off	Over Power	Oscillation	Manual Shut Off
PS700	Uplink 768-805M	12 dB	0 dB	0 dB	Active	ON	Normal	Normal	Normal
	Downlink 753-775M	12 dB	0 dB	0 dB	ON	ON	Normal	Normal	Normal
PS800	Uplink 806-816M	12 dB	0 dB	0 dB	Active	ON	Normal	Normal	Normal
	Downlink 851-861M	12 dB	0 dB	0 dB	ON	ON	Normal	Normal	Normal

Sentry Software Version: NetGuardian4A V2.4.5

Device Status: ● Normal Outdoor Antenna: ● Normal Power Supply: v

In1 Alarm: ● Normal In2 Alarm: ● Normal

Refresh
Set

From the dashboard above you can manually adjust the attenuation dB to resolve problems. You can also turn off individual bands.



## CHAPTER 8: SPECIFICATIONS

Electrical			700 MHz	800 MHz
		Unit of measure		
Frequency Range, Uplink		MHz	788-805	806 – 816
Frequency Range, Downlink		MHz	758-775	851 – 861
Total Output Power, Uplink		dBm	27±1	27±1
Total Output Power, Downlink		dBm	33±1	33±1
Norminal System Gain		dB	80	80
Gain Adjustment Range (1dB step)		dB	0-30	0-30
Pass Band Ripple, p-p		dB	≤5	≤5
Uplink Noise Figure		dB	≤5	≤5
Intermodulation		dBm	≤-13	≤-13
Spurious	9 kHz to 1 GHz	dBm	FCC Compliance	FCC Compliance
	1 GHz to 12.75 GHz	dBm	FCC Compliance	FCC Compliance
Absolute Maximum RF Input Power		dBm	-10	-10
Impedance:		ohm	50Ω	50Ω
FCC ID:			2AXVJGUARD-BUL	
Certifications			FCC Part 90	

### Mechanical Specifications

Dimensions (H x W x D):		in (mm)	21.2 x 17.2 x 8.0 in (550 x 436 x 203 mm)	
Weight (Booster only):		lbs (kg)	45.9 lbs (20.8 kg)	
Weight (Box as shipped):		lbs	53 lbs	
Power Supply		AC	100 – 240 / 50 – 60 Hz	
		DC	23 – 30 V	
Power Consumption	Single band	W	40	
	Dual band	W	47	
Enclosure Cooling			Convection	
RF Connectors			N-Female	
Operating Temperature		°F (°C)	-4 to +122 (-20 to +50)	
Operating Humidity			95%	
Environmental Class:			NEMA-4	

## CHAPTER 9: SAFETY AND COMPLIANCE

### 9.1 FCC Compliance

The product has been tested and found to comply with the Booster Requirements per FCC Part 90.

## Part 90 Signal Boosters THIS IS A 90.219 CLASS B DEVICE

WARNING: This is NOT a CONSUMER device. It is designed for installation by FCC LICENSEES and QUALIFIED INSTALLERS. You MUST have an FCC LICENSE or the express consent of an FCC Licensee to operate this device. You MUST register Class B signal boosters (as defined in 47 CFR 90.219) online at [www.fcc.gov/signal-boosters/registration](http://www.fcc.gov/signal-boosters/registration). Unauthorized use may result in significant forfeiture penalties, including penalties in excess of \$100,000 for each continuing violation.

Unauthorized use may result in significant forfeiture penalties, including penalties in excess of \$100,000 for each continuing violation.

15.105: This equipment has been tested and found to comply with the limits for a Class B digital device, pursuant to part 15 of the FCC Rules. These limits are designed to provide reasonable protection against harmful interference in a residential installation. This equipment generates, uses and can radiate radio frequency energy and, if not installed and used in accordance with the instructions, may cause harmful interference to radio communications. However, there is no guarantee that interference will not occur in a particular installation. If this equipment does cause harmful interference to radio or television reception, which can be determined by turning the equipment off and on, the user is encouraged to try to correct the interference by one or more of the following measures:

- Reorient or relocate the receiving antenna
- Increase the separation between the equipment and receiver.
- Connect the equipment into an outlet on a circuit different from that to which the receiver is connected
- Consult the dealer or an experienced radio/TV technician for help.



WARNING: CHANGES OR MODIFICATIONS NOT EXPRESSLY APPROVED BY TOWERIQ COULD VOID THE USER'S AUTHORITY TO OPERATE THE EQUIPMENT.

## CHAPTER 10: WARRANTY

Activate your product warranty at <https://toweriq.nyc/products/guardian-series>

For questions regarding your warranty, contact a TowerIQ representative at 844-626-7638 or email [guardian@tower-iq.com](mailto:guardian@tower-iq.com).

### 10.1 Warranty Periods

Your warranty includes the following periods:

- **Three-Year Product Warranty:** TowerIQ products are covered under a three-year product warranty from the date of purchase. This protects the customer from any defects or problems the product may have that are solely the fault of TowerIQ. Incorrect installation or misuse will void this warranty. Upon the return of a defective product, TowerIQ will issue the customer a working replacement. All returned packages should contain all products distributed.
- **Five-Year Extended Product Warranty:** A five year warranty is available for purchase on any products sold by TowerIQ. A five-year warranty must be obtained at the time of purchase. This warranty adds an additional two years to the three year warranty we provide. All regulations still apply.

### 10.2 Three-Year Product Warranty

TowerIQ warrants its products for three years from the date of purchase against defects in workmanship and/or materials. Specifications are subject to change. The three-year warranty only applies to products meeting the latest FCC Certification Guidelines stated on 2/20/2013 and going into effect April 30, 2014. A two-year warranty applies to any products manufactured before May 1, 2014.

Products returned by customers must be in their original, un-modified condition, shipped in the original or protective packaging with proof-of-purchase documentation enclosed, and a Return Merchandise Authorization (RMA) number printed clearly on the outside of the shipping container.

Buyers may obtain an RMA number for warranty returns by calling the TowerIQ Return Department toll-free at 1-888-365-6283. Any returns received by TowerIQ without an RMA number clearly printed on the outside of the shipping container will be returned to sender. In order to receive full credit for signal boosters, all accessories originally included in the signal booster box must be returned with the signal booster. (The Buyer does not need to include accessories sold in addition to the signal booster, such as antennas or cables.)

This warranty does not apply to any product determined by TowerIQ to have been subjected to misuse, abuse, neglect, or mishandling that alters or damages the product's physical or electronic properties.

TowerIQ warrants to the Buyer that each of its products, when shipped, will be free from defects in material and workmanship, and will perform in full accordance with applicable specifications. The limit of liability under this warranty is, at TowerIQ's option, to repair or replace any product or part thereof which was purchased up to THREE YEARS after May 1, 2014 or TWO YEARS for products purchased before May 1, 2014, as determined by examination by TowerIQ, prove defective in material and/or workmanship. Warranty returns must first be authorized in writing by TowerIQ. Disassembly of any TowerIQ product by anyone other than an authorized representative of TowerIQ voids this warranty in its entirety. TowerIQ reserves the right to make changes in any of its products without incurring any obligation to make the same changes on previously delivered products.

As a condition to the warranties provided for herein, the Buyer will prepay the shipping charges for all products returned to TowerIQ for repair, and TowerIQ will pay the return shipping with the exception of products returned from outside the United States, in which case the Buyer will pay the shipping charges.

The Buyer will pay the cost of inspecting and testing any goods returned under the warranty or otherwise, which are found to meet the applicable specifications or which are not defective or not covered by this warranty.

Products sold by TowerIQ shall not be considered defective or non-conforming to the Buyer's order if they satisfactorily fulfill the performance requirements that were published in the product specification literature, or in accordance with samples provided by TowerIQ. This warranty shall not apply to any products or parts thereof which have been subject to accident, negligence, alteration, abuse, or misuse. TowerIQ makes no warranty whatsoever in respect to accessories or parts not supplied by it.

### 10.3 Limitations of Warranty, Damages and Liability

EXCEPT AS EXPRESSLY SET FORTH HEREIN, THERE ARE NO WARRANTIES, CONDITIONS, GUARANTEES, OR REPRESENTATIONS AS TO MERCHANTABILITY, FITNESS FOR A PARTICULAR PURPOSE, OR OTHER WARRANTIES, CONDITIONS, GUARANTEES, OR REPRESENTATIONS, WHETHER EXPRESSED OR IMPLIED, IN LAW OR IN FACT, ORAL OR IN WRITING.

TOWERIQ AGGREGATE LIABILITY IN DAMAGES OR OTHERWISE SHALL NOT EXCEED THE PAYMENT, IF ANY, RECEIVED BY CELLPHONE-MATE, INC. FOR THE UNIT OF PRODUCT OR SERVICE FURNISHED OR TO BE FURNISHED, AS THE CASE MAY BE, WHICH IS THE SUBJECT OF CLAIM OR

DISPUTE. IN NO EVENT SHALL TOWERIQ BE LIABLE FOR INCIDENTAL, CONSEQUENTIAL, OR SPECIAL DAMAGES, HOWSOEVER CAUSED.

All matters regarding this warranty shall be interpreted in accordance with the laws of the State of California, and any controversy that cannot be settled directly shall be settled by arbitration in California in accordance with the rules then prevailing of the American Arbitration Association, and judgment upon the award rendered may be entered in any court having jurisdiction thereof. If one or more provisions provided herein are held to be invalid or unenforceable under applicable law, then such provision shall be ineffective and excluded to the extent of such invalidity or unenforceability without affecting in any way the remaining provisions hereof.

**WARNING: E911 location information may not be provided or may be inaccurate for calls served BY USING THIS DEVICE.**

1609 Park 370 Place,  
Hazelwood, MO 63042  
844-626-7638  
[www.toweriq.nyc](http://www.toweriq.nyc)

TowerIQ has made a good faith effort to ensure the accuracy of the information in this document and disclaims the implied warranties of merchantability and fitness for a particular purpose and makes no express warranties, except as may be stated in its written agreement with and for its customers. TowerIQ shall not be held liable to anyone for any indirect, special or consequential damages due to omissions or errors. The information and specifications in this document are subject to change without notice.

© 2020. All Rights Reserved. All trademarks and registered trademarks are the property of their respective owners.

TowerIQ, Inc  
1609 Park 370 Place,  
Hazelwood, MO 63042, USA  
844-626-7638 | [www.toweriq.nyc](http://www.toweriq.nyc)