

TEST REPORT

Applicant Name : SHENZHEN MOCLOUD TECHNOLOGY CO., LTD
Address : Rm 1401-02, Huatong Bldg., Ganli 2nd Road, Jihua Town, Longgang Dist.
Shenzhen, China
Report Number : RA230602-31254E-RF
FCC ID: 2AXUU621-515L

Test Standard (s)

FCC PART 15.247

Sample Description

Product Type: SPEAKER
Model No.: MPD621, MPD515L
Trade Mark: 
Date Received: 2023-06-02
Date of Test: 2023-06-05 to 2023-07-03
Report Date: 2023-07-03

Test Result:	Pass*
--------------	-------

* In the configuration tested, the EUT complied with the standards above.

Prepared and Checked By:

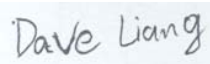

Dave Liang
EMC Engineer

Approved By:



Candy Li
EMC Engineer

Note: This report may contain data that are not covered by the A2LA accreditation and are marked with an asterisk "★".
Shenzhen Accurate Technology Co., Ltd. is not responsible for the authenticity of any test data provided by the applicant. Data included from the applicant that may affect test results are marked with an asterisk "★". Customer model name, addresses, names, trademarks etc. are not considered data.
This report cannot be reproduced except in full, without prior written approval of the Company. Unless otherwise stated the results shown in this test report refer only to the sample(s) tested.
This report is valid only with a valid digital signature. The digital signature may be available only under the Adobe software above version 7.0.

TABLE OF CONTENTS

DOCUMENT REVISION HISTORY	4
GENERAL INFORMATION.....	5
PRODUCT DESCRIPTION FOR EQUIPMENT UNDER TEST (EUT)	5
OBJECTIVE	5
TEST METHODOLOGY	5
MEASUREMENT UNCERTAINTY	6
TEST FACILITY	6
SYSTEM TEST CONFIGURATION.....	7
DESCRIPTION OF TEST CONFIGURATION	7
EUT EXERCISE SOFTWARE	7
SPECIAL ACCESSORIES	7
EQUIPMENT MODIFICATIONS	7
SUPPORT EQUIPMENT LIST AND DETAILS	7
EXTERNAL I/O CABLE.....	7
BLOCK DIAGRAM OF TEST SETUP	8
SUMMARY OF TEST RESULTS.....	10
TEST EQUIPMENT LIST	11
FCC §1.1307 (b) – RF EXPOSURE	12
FCC §15.203 – ANTENNA REQUIREMENT.....	13
APPLICABLE STANDARD	13
ANTENNA CONNECTOR CONSTRUCTION	13
FCC §15.207 (a) – AC LINE CONDUCTED EMISSIONS	14
APPLICABLE STANDARD	14
EUT SETUP.....	14
EMI TEST RECEIVER SETUP.....	14
TEST PROCEDURE	15
FACTOR & OVER LIMIT CALCULATION.....	15
TEST DATA	15
FCC §15.205, §15.209 & §15.247(d) – RADIATED EMISSIONS.....	20
APPLICABLE STANDARD	20
EUT SETUP.....	20
EMI TEST RECEIVER & SPECTRUM ANALYZER SETUP	21
TEST PROCEDURE	21
FACTOR & OVER LIMIT/MARGIN CALCULATION	21
TEST DATA	21
FCC §15.247(a) (1)-CHANNEL SEPARATION TEST	29
APPLICABLE STANDARD	29
TEST PROCEDURE	29
TEST DATA	29
FCC §15.247(a) (1) – 20 dB EMISSION BANDWIDTH & 99% OCCUPIED BANDWIDTH.....	32
APPLICABLE STANDARD	32
TEST PROCEDURE	32
TEST DATA	33
FCC §15.247(a) (1) (iii)-QUANTITY OF HOPPING CHANNEL TEST	43
APPLICABLE STANDARD	43
TEST PROCEDURE	43
TEST DATA	43

FCC §15.247(a) (1) (iii) - TIME OF OCCUPANCY (DWELL TIME).....46
 APPLICABLE STANDARD46
 TEST PROCEDURE46
 TEST DATA46

FCC §15.247(b) (1) - PEAK OUTPUT POWER MEASUREMENT.....56
 APPLICABLE STANDARD56
 TEST PROCEDURE56
 TEST DATA56

FCC §15.247(d) - BAND EDGES TESTING62
 APPLICABLE STANDARD62
 TEST PROCEDURE62
 TEST DATA62

DOCUMENT REVISION HISTORY

Revision Number	Report Number	Description of Revision	Date of Revision
0	RA230602-31254E-RF	Original Report	2023-07-03

GENERAL INFORMATION

Product Description for Equipment under Test (EUT)

Product Type	SPEAKER
Tested Model	MPD621
Multiple Model	MPD515L
Model Difference	Please refer to DOS letter
Frequency Range	Bluetooth:2402-2480MHz
Maximum Conducted Peak Output Power	2.86dBm
Modulation Technique	BDR(GFSK)/EDR($\pi/4$ -DQPSK)/EDR(8DPSK)
Antenna Specification*	Internal Antenna: -0.68dBi(provided by the applicant)
Voltage Range	DC 3.7V from battery or DC 5V from USB port
Sample number	26IF-1 (CE&RE) for MPD621 26IF-2 (CE&RE) for MPD515L 26IE-1 (RF Conducted Test) for MPD621
Sample/EUT Status	Good condition

Objective

This test report is in accordance with Part 2-Subpart J, Part 15-Subparts A and C of the Federal Communication Commission rules.

The tests were performed in order to determine compliance with FCC Part 15, Subpart C, section 15.203, 15.205, 15.207, 15.209 and 15.247 rules.

Test Methodology

All measurements contained in this report were conducted with ANSI C63.10-2013, American National Standard of Procedures for Compliance Testing of Unlicensed Wireless Devices.

All emissions measurement was performed at Shenzhen Accurate Technology Co., Ltd. The radiated testing was performed at an antenna-to-EUT distance of 3 meters.

Measurement Uncertainty

Parameter		Uncertainty
Occupied Channel Bandwidth		5%
RF Frequency		0.082×10^{-7}
RF output power, conducted		0.71dB
Unwanted Emission, conducted		1.6dB
AC Power Lines Conducted Emissions		2.74dB
Emissions, Radiated	30MHz - 1GHz	5.08dB
	1GHz - 18GHz	4.96dB
	18GHz - 26.5GHz	5.16dB
Temperature		1°C
Humidity		6%
Supply voltages		0.4%

Note: The extended uncertainty given in this report is obtained by combining the standard uncertainty times the coverage factor K with the 95% confidence interval. Otherwise required by the applicant or Product Regulations, Decision Rule in this report did not consider the uncertainty.

Test Facility

The test site used by Shenzhen Accurate Technology Co., Ltd. to collect test data is located on the Floor 1, KuMaKe Building, Dongzhou Community, Guangming Street, Guangming District, Shenzhen, Guangdong, China.

The test site has been approved by the FCC under the KDB 974614 D01 and is listed in the FCC Public Access Link (PAL) database, FCC Registration No.: 708358, the FCC Designation No.: CN1189.

Accredited by American Association for Laboratory Accreditation (A2LA). The Certificate Number is 4297.01.

The lab has been recognized by Innovation, Science and Economic Development Canada to test to Canadian radio equipment requirements, the CAB identifier: CN0016. The Registration Number is 30241.

SYSTEM TEST CONFIGURATION

Description of Test Configuration

The system was configured for testing in an engineering mode.

EUT Exercise Software

Software “BT-TOOL” was used during testing and the power level was default 7*.

Special Accessories

N/A.

Equipment Modifications

No modification was made to the EUT tested.

Support Equipment List and Details

Manufacturer	Description	Model	Serial Number
Unknown	Adapter	CEPIC3M	Unknown
kingston	TF card	Unknown	Unknown
kingston	USB flash disk	Unknown	Unknown
Redmi	Mobile phone	K20Pro	Unknown
Unknown	Wired microphone	Unknown	Unknown

External I/O Cable

Cable Description	Length (m)	From Port	To
Un-shielding Detachable USB Cable	1.0	Adapter	EUT
Un-shielding Detachable AUX Cable	1.15	Mobile phone	EUT
Un-shielding Un-Detachable Audio Cable	2.85	Wired microphone	EUT

Block Diagram of Test Setup

For Conducted Emission:

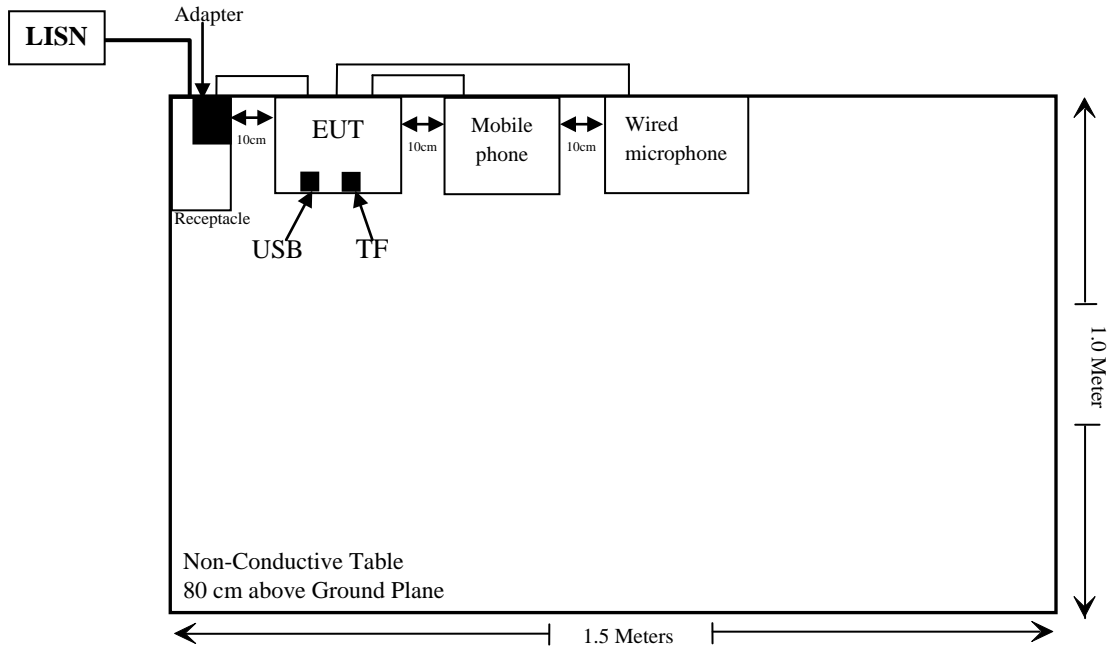

For Radiated Emission:

Below 1GHz

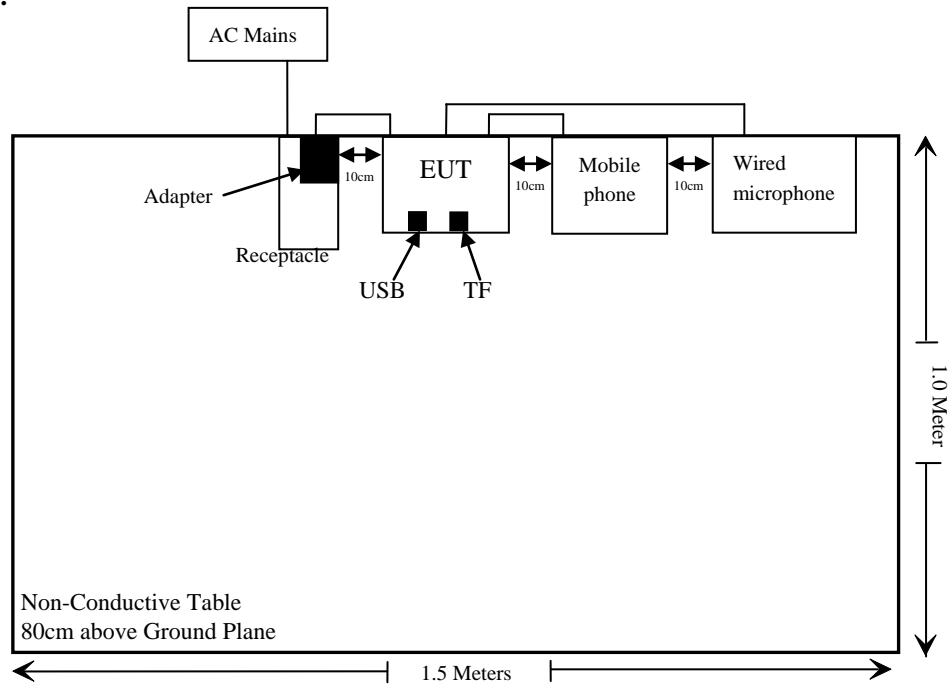

Above 1GHz

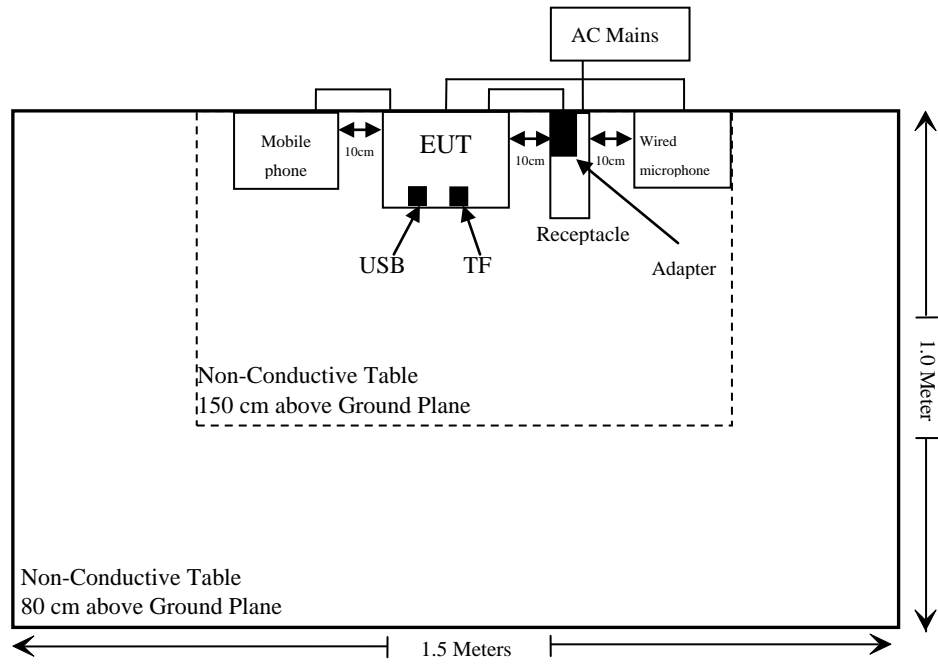

Note: the support table edge was flush with the center of turntable.

SUMMARY OF TEST RESULTS

FCC Rules	Description of Test	Result
§1.1307 (b)	RF Exposure	Compliant
§15.203	Antenna Requirement	Compliant
§15.207(a)	AC Line Conducted Emissions	Compliant
§15.205, §15.209 & §15.247(d)	Radiated Emissions	Compliant
§15.247(a)(1)	20 dB Emission Bandwidth & 99% Occupied Bandwidth	Compliant
§15.247(a)(1)	Channel Separation Test	Compliant
§15.247(a)(1)(iii)	Time of Occupancy (Dwell Time)	Compliant
§15.247(a)(1)(iii)	Quantity of hopping channel Test	Compliant
§15.247(b)(1)	Peak Output Power Measurement	Compliant
§15.247(d)	Band edges	Compliant

TEST EQUIPMENT LIST

Manufacturer	Description	Model	Serial Number	Calibration Date	Calibration Due Date
Conducted Emission Test					
Rohde & Schwarz	EMI Test Receiver	ESCI	100784	2022/11/25	2023/11/24
Rohde & Schwarz	L.I.S.N.	ENV216	101314	2022/11/25	2023/11/24
Anritsu Corp	50 Coaxial Switch	MP59B	6100237248	2022/12/07	2023/12/06
Unknown	RF Coaxial Cable	No.17	N0350	2022/11/25	2023/11/24
Conducted Emission Test Software: e3 191218 (V9)					
Radiated Emissions Test					
Rohde & Schwarz	Test Receiver	ESR	102725	2022/11/25	2023/11/24
Rohde & Schwarz	Spectrum Analyzer	FSV40	101949	2022/11/25	2023/11/24
SONOMA INSTRUMENT	Amplifier	310 N	186131	2022/11/08	2023/11/07
A.H. Systems, inc.	Preamplifier	PAM-0118P	135	2022/11/08	2023/11/07
Quinstar	Amplifier	QLW-184055 36-J0	15964001002	2022/11/08	2023/11/07
Schwarzbeck	Bilog Antenna	VULB9163	9163-323	2021/07/06	2024/07/05
Schwarzbeck	Horn Antenna	BBHA9120D	837	2023/02/22	2026/02/21
Schwarzbeck	HORN ANTENNA	BBHA9170	9170-359	2022/12/26	2025/12/25
Unknown	RF Coaxial Cable	No.10	N050	2022/11/25	2023/11/24
Unknown	RF Coaxial Cable	No.11	N1000	2022/11/25	2023/11/24
Unknown	RF Coaxial Cable	No.12	N040	2022/11/25	2023/11/24
Unknown	RF Coaxial Cable	No.13	N300	2022/11/25	2023/11/24
Unknown	RF Coaxial Cable	No.14	N800	2022/11/25	2023/11/24
Unknown	RF Coaxial Cable	No.15	N600	2022/11/25	2023/11/24
Unknown	RF Coaxial Cable	No.16	N650	2022/11/25	2023/11/24
Wainwright	High Pass Filter	WHKX3.6/18 G-10SS	5	2022/11/25	2023/11/24
Radiated Emission Test Software: e3 191218 (V9)					
RF Conducted Test					
Rohde & Schwarz	Spectrum Analyzer	FSV-40	101495	2022/11/25	2023/11/24
Rohde & Schwarz	Open Switch and Control Unit	OSP120 + OSP-B157	101244 + 100866	2022/11/25	2023/11/24
WEINSCHTEL	10dB Attenuator	5324	AU 3842	2022/11/25	2023/11/24
Unknown	RF Coaxial Cable	No.31	RF-01	Each time	

* **Statement of Traceability:** Shenzhen Accurate Technology Co., Ltd. attests that all calibrations have been performed in accordance to requirements that traceable to National Primary Standards and International System of Units (SI).

FCC §1.1307 (b) – RF EXPOSURE

Applicable Standard

According to KDB 447498 D04 Interim General RF Exposure Guidance v01, clause 2.1.4 –MPE-Based Exemption:

An alternative to the SAR-based exemption is provided in § 1.1307(b)(3)(i)(C), for a much wider frequency range, from 300 kHz to 100 GHz, applicable for separation distances greater or equal to $\lambda/2\pi$, where λ is the free-space operating wavelength in meters. The MPE-based test exemption condition is in terms of ERP, defined as the product of the maximum antenna gain and the delivered maximum time-averaged power. For this case, a RF source is an RF exempt device if its ERP (watts) is no more than a frequency-dependent value, as detailed tabular form in Appendix B. These limits have been derived based on the basic specifications on Maximum Permissible Exposure (MPE) considered for the FCC rules in § 1.1310(e)(1).

Table to § 1.1307(b)(3)(i)(C) - Single RF Sources Subject to Routine Environmental Evaluation

RF Source frequency (MHz)	Threshold ERP (watts)
0.3-1.34	$1,920 R^2$.
1.34-30	$3,450 R^2/f^2$.
30-300	$3.83 R^2$.
300-1,500	$0.0128 R^2f$.
1,500-100,000	$19.2R^2$.

f = frequency in MHz;

R = minimum separation distance from the body of a nearby person (appropriate units, e.g., m);

Test Result

For worst case:

Mode	Frequency Range (MHz)	Tune-up Output Power		Antenna Gain		ERP		Evaluation Distance (cm)	MPE-Based Exemption Threshold (mW)
		(dBm)	(mW)	(dBi)	(dBd)	(dBm)	(mW)		
BDR/EDR	2402-2480	3	2	-0.68	-2.83	0.17	1.04	20	768

Note 1: The tune-up power was declared by the applicant.

Note 2: 0dBd=2.15dBi.

To maintain compliance with the FCC's RF exposure guidelines, place the equipment at least 20cm from nearby persons.

Result: Compliant.

FCC §15.203 – ANTENNA REQUIREMENT

Applicable Standard

According to FCC § 15.203, an intentional radiator shall be designed to ensure that no antenna other than that furnished by the responsible party shall be used with the device. The use of a permanently attached antenna or of an antenna that uses a unique coupling to the intentional radiator shall be considered sufficient to comply with the provisions of this Section. The manufacturer may design the unit so that a broken antenna can be replaced by the user, but the use of a standard antenna jack or electrical connector is prohibited.

Antenna Connector Construction

The EUT has one internal antenna arrangement, which was permanently attached and the antenna gain is -0.68dBi, fulfill the requirement of this section. Please refer to the EUT photos.

Result: Compliant.

FCC §15.207 (a) – AC LINE CONDUCTED EMISSIONS

Applicable Standard

FCC §15.207(a)

EUT Setup

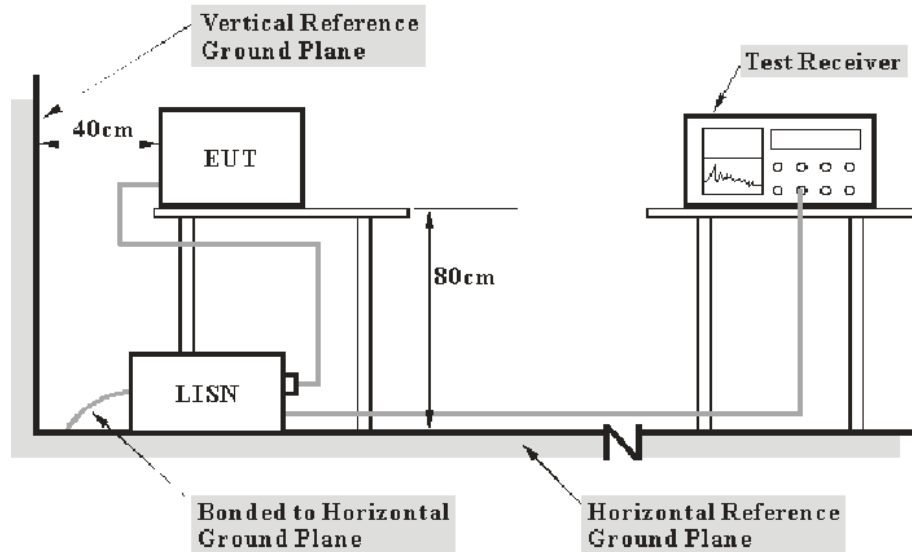

- Note: 1. Support units were connected to second LISN.
 2. Both of LISNs (AMN) 80 cm from EUT and at the least 80 cm from other units and other metal planes support units.

The measurement procedure of EUT setup is according with ANSI C63.10-2013. The related limit was specified in FCC Part 15.207.

The spacing between the peripherals was 10 cm.

EMI Test Receiver Setup

The EMI test receiver was set to investigate the spectrum from 150 kHz to 30 MHz.

During the conducted emission test, the EMI test receiver was set with the following configurations:

Frequency Range	IF B/W
150 kHz – 30 MHz	9 kHz

Test Procedure

During the conducted emission test, the adapter was connected to the outlet of the LISN.

Maximizing procedure was performed on the six (6) highest emissions of the EUT.

All final data was recorded in the Quasi-peak and average detection mode.

Factor & Over Limit Calculation

The factor is calculated by adding LISN VDF (Voltage Division Factor) and Cable Loss. The basic equation is as follows:

$$\text{Factor} = \text{LISN VDF} + \text{Cable Loss}$$

The “**Over limit**” column of the following data tables indicates the degree of compliance with the applicable limit. For example, an Over limit of -7 dB means the emission is 7 dB below the limit. The equation for calculation is as follows:

$$\begin{aligned} \text{Over Limit} &= \text{Level} - \text{Limit} \\ \text{Level} &= \text{Read Level} + \text{Factor} \end{aligned}$$

Test Data

Environmental Conditions

Temperature:	24°C
Relative Humidity:	53 %
ATM Pressure:	101.0kPa

The testing was performed by Jeef Huang on 2023-07-03

EUT operation mode: BT Transmitting (worst case 8DPSK High channel)

Tested Model: MPD621

AC 120V/60 Hz, Line

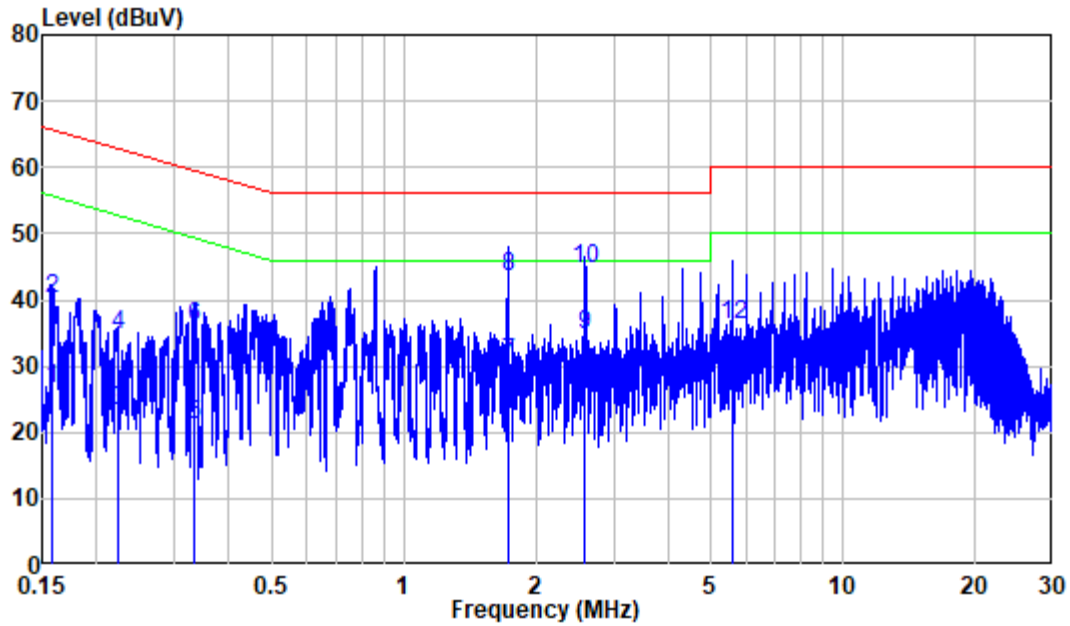

Site : Shielding Room
 Condition: Line
 Job No. : RA230602-31254E-RF
 Mode : BT Transmitting
 Power : AC 120V 60Hz

	Freq	Factor	Read Level	Limit Level	Limit Line	Over Limit	Remark
	MHz	dB	dBuV	dBuV	dBuV	dB	
1	0.158	10.36	16.23	26.59	55.55	-28.96	Average
2	0.158	10.36	29.89	40.25	65.55	-25.30	QP
3	0.223	10.31	12.89	23.20	52.71	-29.51	Average
4	0.223	10.31	24.45	34.76	62.71	-27.95	QP
5	0.332	10.43	10.85	21.28	49.40	-28.12	Average
6	0.332	10.43	25.36	35.79	59.40	-23.61	QP
7	1.731	10.41	20.07	30.48	46.00	-15.52	Average
8	1.731	10.41	33.04	43.45	56.00	-12.55	QP
9	2.582	10.46	24.32	34.78	46.00	-11.22	Average
10	2.582	10.46	34.08	44.54	56.00	-11.46	QP
11	5.605	10.57	14.38	24.95	50.00	-25.05	Average
12	5.605	10.57	25.54	36.11	60.00	-23.89	QP

AC 120V/60 Hz, Neutral

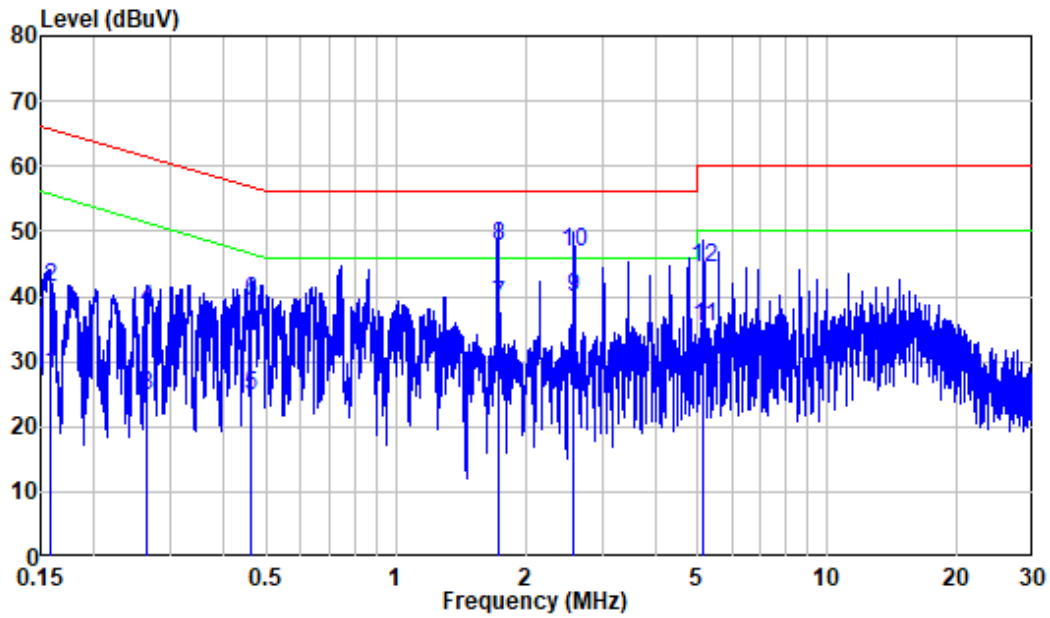

Site : Shielding Room
 Condition: Neutral
 Job No. : RA230602-31254E-RF
 Mode : BT Transmitting
 Power : AC 120V 60Hz

	Freq	Factor	Read Level	Limit Level	Limit Line	Over Limit	Remark
	MHz	dB	dBuV	dBuV	dBuV	dB	
1	0.159	10.28	17.75	28.03	55.53	-27.50	Average
2	0.159	10.28	31.08	41.36	65.53	-24.17	QP
3	0.264	10.34	14.28	24.62	51.31	-26.69	Average
4	0.264	10.34	27.84	38.18	61.31	-23.13	QP
5	0.462	10.45	14.37	24.82	46.65	-21.83	Average
6	0.462	10.45	28.66	39.11	56.65	-17.54	QP
7	1.729	10.47	28.24	38.71	46.00	-7.29	Average
8	1.729	10.47	37.36	47.83	56.00	-8.17	QP
9	2.588	10.52	29.43	39.95	46.00	-6.05	Average
10	2.588	10.52	36.40	46.92	56.00	-9.08	QP
11	5.170	10.51	24.93	35.44	50.00	-14.56	Average
12	5.170	10.51	33.91	44.42	60.00	-15.58	QP

Multiple Model: MPD515L

AC 120V/60 Hz, Line

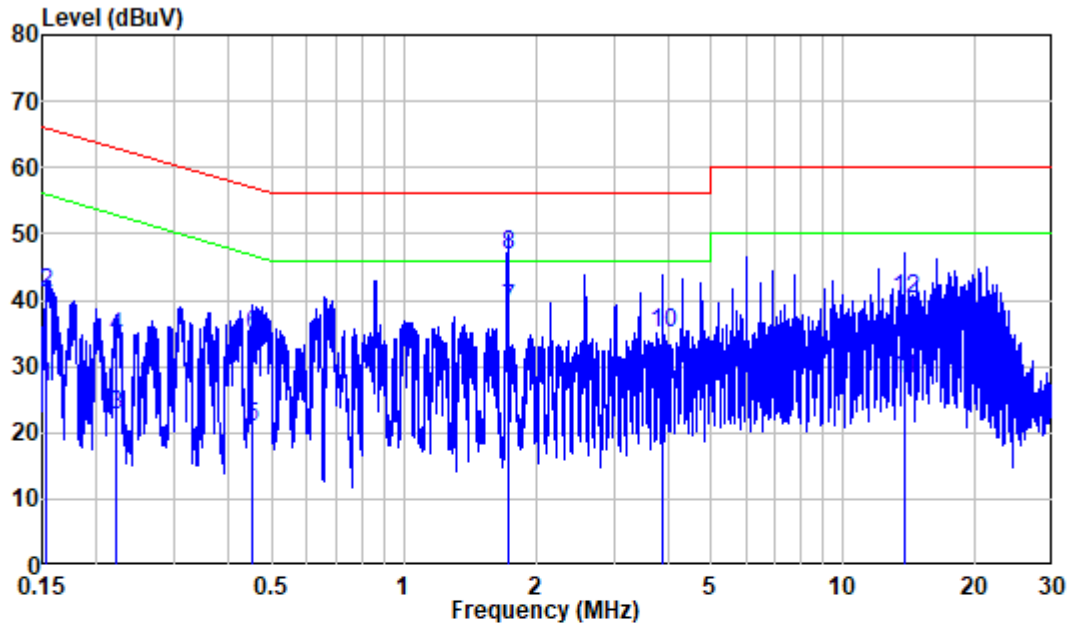

Site : Shielding Room
 Condition: Line
 Job No. : RA230602-31254E-RF
 Mode : BT Transmitting
 Power : AC 120V 60Hz

	Freq	Factor	Read Level	Limit Level	Limit Line	Over Limit	Remark
	MHz	dB	dBuV	dBuV	dBuV	dB	
1	0.154	10.36	16.53	26.89	55.79	-28.90	Average
2	0.154	10.36	30.64	41.00	65.79	-24.79	QP
3	0.221	10.31	12.22	22.53	52.80	-30.27	Average
4	0.221	10.31	24.21	34.52	62.80	-28.28	QP
5	0.453	10.54	10.25	20.79	46.81	-26.02	Average
6	0.453	10.54	24.24	34.78	56.81	-22.03	QP
7	1.723	10.41	28.15	38.56	46.00	-7.44	Average
8	1.723	10.41	36.45	46.86	56.00	-9.14	QP
9	3.871	10.54	14.07	24.61	46.00	-21.39	Average
10	3.871	10.54	24.57	35.11	56.00	-20.89	QP
11	13.786	10.27	17.92	28.19	50.00	-21.81	Average
12	13.786	10.27	29.89	40.16	60.00	-19.84	QP

AC 120V/60 Hz, Neutral

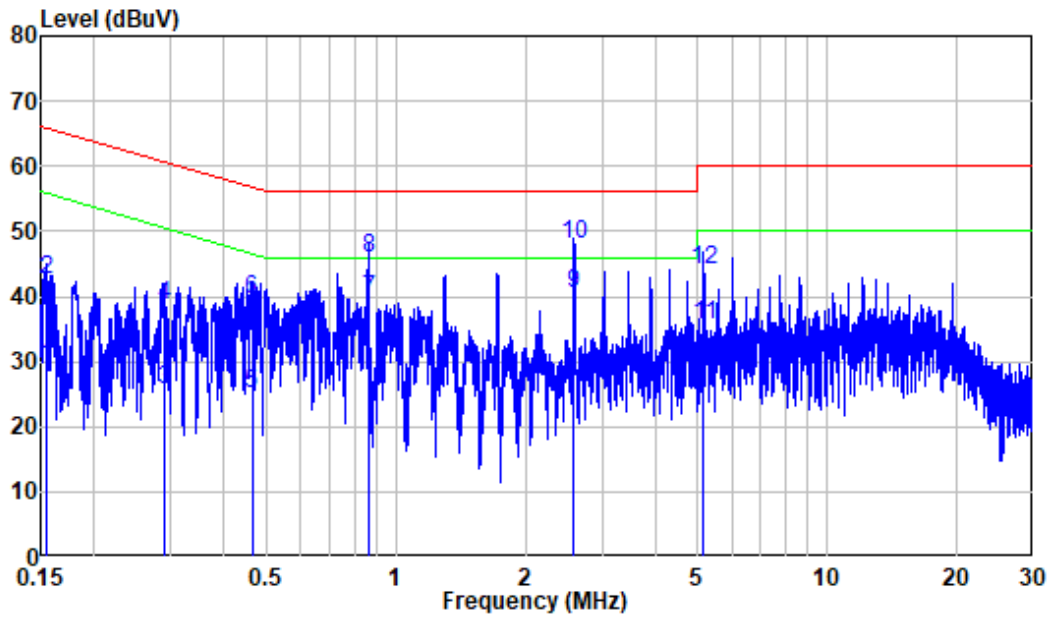

Site : Shielding Room
 Condition: Neutral
 Job No. : RA230602-31254E-RF
 Mode : BT Transmitting
 Power : AC 120V 60Hz

	Freq	Factor	Read Level	Limit Level	Limit Line	Over Limit	Remark
	MHz	dB	dBuV	dBuV	dBuV	dB	
1	0.155	10.28	19.13	29.41	55.72	-26.31	Average
2	0.155	10.28	32.36	42.64	65.72	-23.08	QP
3	0.289	10.35	15.34	25.69	50.55	-24.86	Average
4	0.289	10.35	28.25	38.60	60.55	-21.95	QP
5	0.463	10.45	14.57	25.02	46.63	-21.61	Average
6	0.463	10.45	29.01	39.46	56.63	-17.17	QP
7	0.865	10.40	29.04	39.44	46.00	-6.56	Average
8	0.865	10.40	35.61	46.01	56.00	-9.99	QP
9	2.582	10.52	30.01	40.53	46.00	-5.47	Average
10	2.582	10.52	37.36	47.88	56.00	-8.12	QP
11	5.170	10.51	25.22	35.73	50.00	-14.27	Average
12	5.170	10.51	33.71	44.22	60.00	-15.78	QP

FCC §15.205, §15.209 & §15.247(d) – RADIATED EMISSIONS**Applicable Standard**

FCC §15.205; §15.209; §15.247(d)

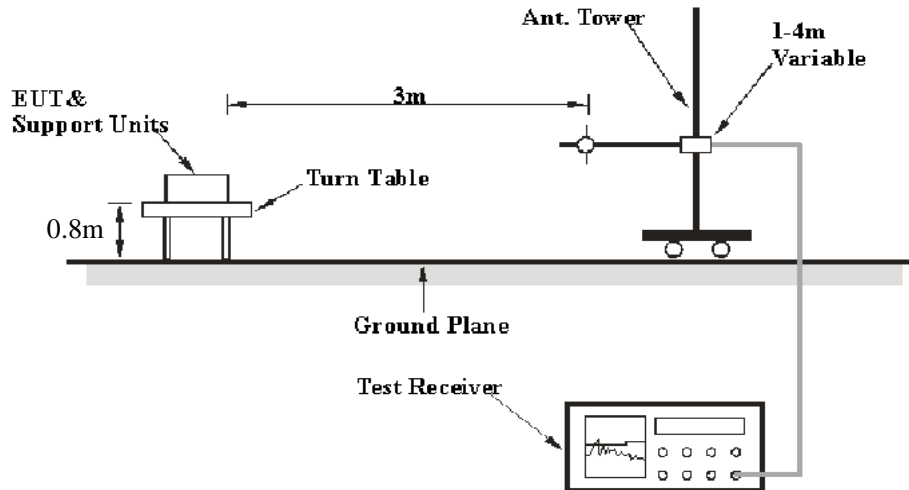
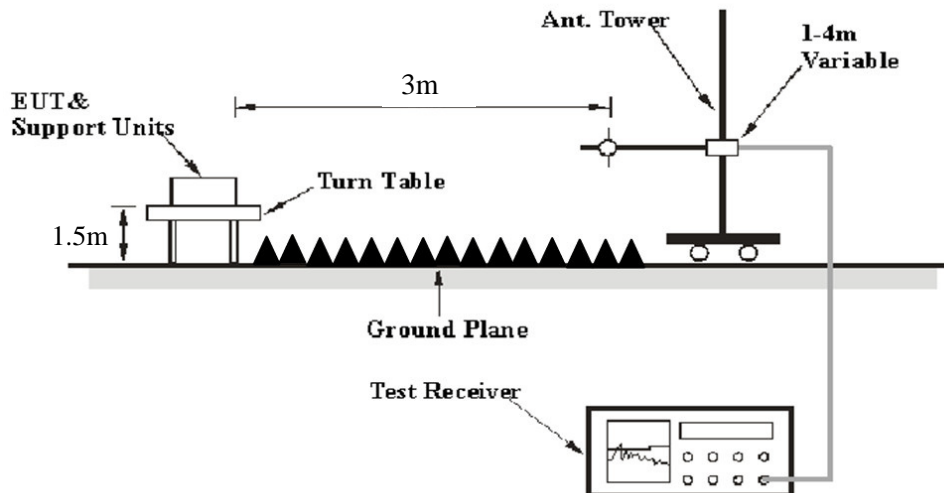
EUT Setup**Below 1 GHz:****Above 1GHz:**

The radiated emission performed in the 3 meters, using the setup accordance with the ANSI C63.10-2013. The specification used was the FCC 15.209, FCC 15.247 limits.

EMI Test Receiver & Spectrum Analyzer Setup

The EMI test receiver & Spectrum Analyzer Setup were set with the following configurations:

Frequency Range	RBW	Video B/W	IF B/W	Measurement
30 MHz – 1000 MHz	100 kHz	300 kHz	120 kHz	QP
Above 1 GHz	1 MHz	3 MHz	/	PK

For average measurement:

Use the duty cycle factor correction factor method per 15.35(c).

Duty cycle=On time/100milliseconds, On time= $N_1 * L_1 + N_2 * L_2 + \dots + N_{n-1} * L_{n-1} + N_n * L_n$,

Where N_1 is number of type 1 pulses, L_1 is length of type 1 pulse, etc.

Average Emission Level=Peak Emission Level+20*log(Duty cycle)

Test Procedure

Maximizing procedure was performed on the highest emissions to ensure that the EUT complied with all installation combinations.

All final data was recorded in Quasi-peak detection mode for frequency range of 30 MHz -1 GHz and peak and Average detection modes for frequencies above 1 GHz.

If the maximized peak measured value complies with the limit, then it is unnecessary to perform an QP/Average measurement

Factor & Over Limit/Margin Calculation

The Factor is calculated by adding the Antenna Factor and Cable Loss, and subtracting the Amplifier Gain. The basic equation is as follows:

$$\text{Factor} = \text{Antenna Factor} + \text{Cable Loss} - \text{Amplifier Gain}$$

The “**Over Limit/Margin**” column of the following data tables indicates the degree of compliance with the applicable limit. For example, an Over Limit/margin of -7dB means the emission is 7dB below the limit. The equation for calculation is as follows:

$$\begin{aligned} \text{Over Limit/Margin} &= \text{Level} / \text{Corrected Amplitude} - \text{Limit} \\ \text{Level} / \text{Corrected Amplitude} &= \text{Read Level} + \text{Factor} \end{aligned}$$

Test Data

Environmental Conditions

Temperature:	22-24°C
Relative Humidity:	50-56%
ATM Pressure:	101.0kPa

The Below 1GHz testing was performed by Jason Liu on 2023-06-08 and 2023-06-13.

The Above 1GHz testing was performed by Jimi Zheng on 2023-06-05.

EUT operation mode: Charging + BT Transmitting

(Pre-scan in the X, Y and Z axes of orientation, the worst case X-axis of orientation was recorded)

Below 1GHz:

Worst case for 8DPSK, High Channel:

Tested Model: MPD621

Horizontal

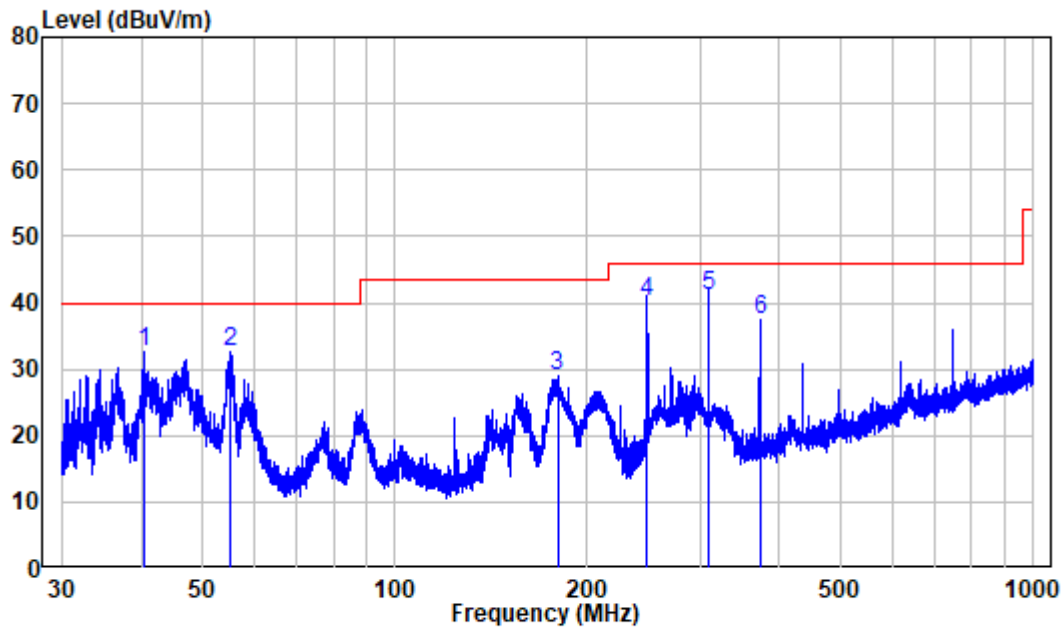

Site : chamber
 Condition: 3m HORIZONTAL
 Job No. : RA230602-31254E-RF
 Test Mode: Charging+BT Transmitting

	Freq	Factor	Read Level	Limit Level	Limit Line	Over Limit	Remark
	MHz	dB/m	dBuV	dBuV/m	dBuV/m	dB	
1	40.541	-10.26	42.80	32.54	40.00	-7.46	Peak
2	55.027	-10.28	42.84	32.56	40.00	-7.44	Peak
3	179.622	-12.81	41.85	29.04	43.50	-14.46	Peak
4	248.443	-10.69	50.87	40.18	46.00	-5.82	QP
5	310.542	-8.88	50.02	41.14	46.00	-4.86	QP
6	372.657	-7.29	44.78	37.49	46.00	-8.51	Peak

Vertical

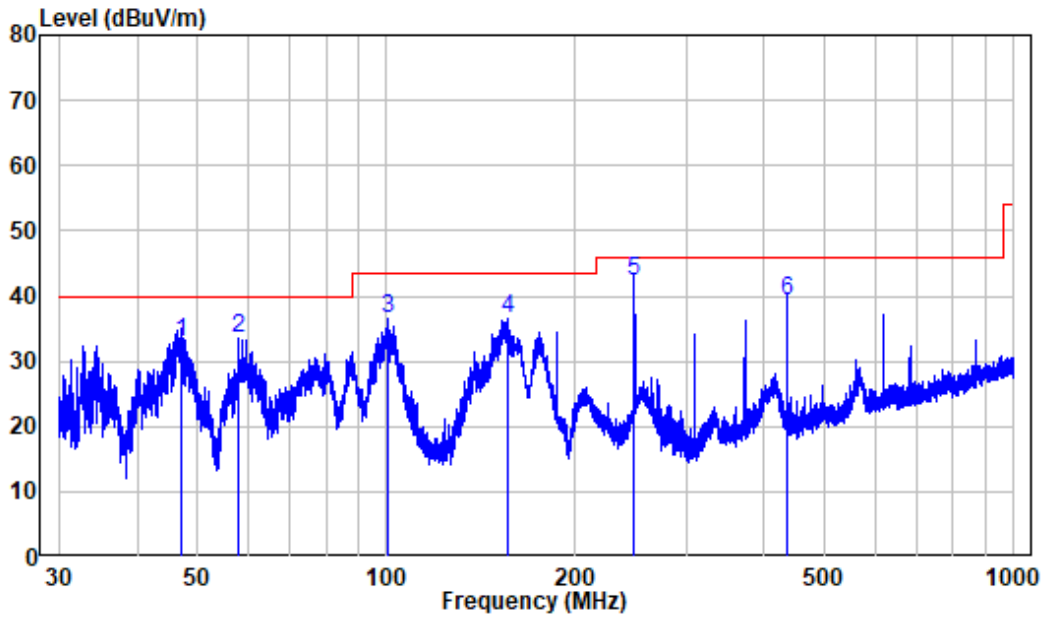

Site : chamber
 Condition: 3m VERTICAL
 Job No. : RA230602-31254E-RF
 Test Mode: Charging+BT Transmitting

	Freq	Factor	Read Level	Level	Limit Line	Over Limit	Remark
	MHz	dB/m	dBuV	dBuV/m	dBuV/m	dB	
1	47.077	-10.00	43.05	33.05	40.00	-6.95	QP
2	58.127	-9.95	43.48	33.53	40.00	-6.47	Peak
3	100.273	-11.77	48.18	36.41	43.50	-7.09	Peak
4	155.774	-14.85	51.37	36.52	43.50	-6.98	Peak
5	248.334	-10.68	53.06	42.38	46.00	-3.62	QP
6	434.636	-5.72	44.83	39.11	46.00	-6.89	QP

Multiple Model: MPD515L

Horizontal

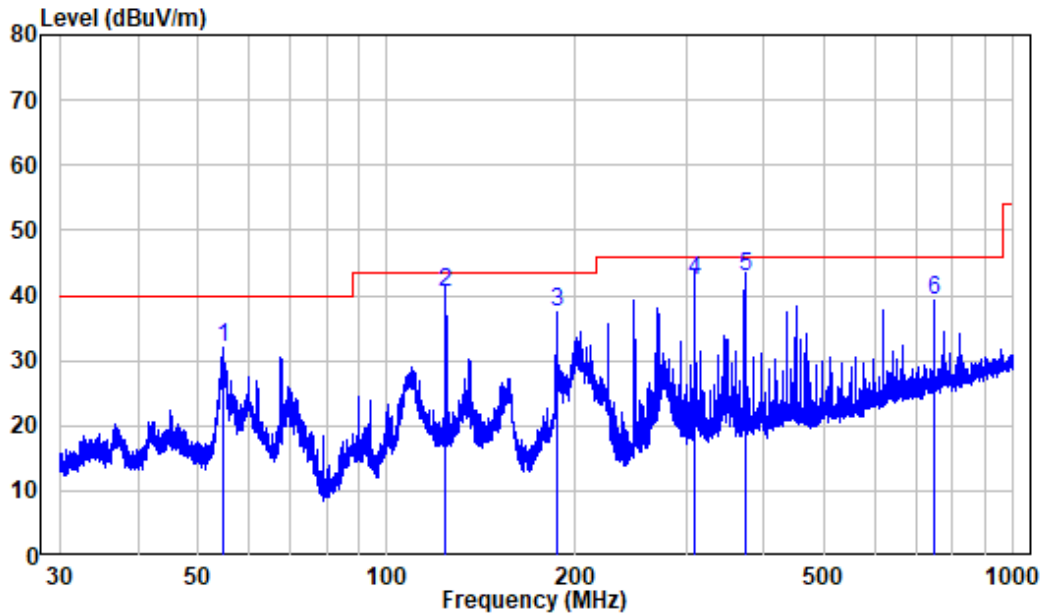

Site : chamber
 Condition: 3m HORIZONTAL
 Job No. : RA230602-31254E-RF
 Test Mode: Charging+BT Transmitting

	Freq	Factor	Read Level	Level	Limit	Over	Remark
	MHz	dB/m	dBuV	dBuV/m	dBuV/m	dB	
1	54.883	-10.29	42.28	31.99	40.00	-8.01	Peak
2	124.187	-14.23	54.60	40.37	43.50	-3.13	QP
3	186.278	-12.02	49.49	37.47	43.50	-6.03	Peak
4	310.542	-8.88	51.01	42.13	46.00	-3.87	QP
5	372.657	-7.29	50.20	42.91	46.00	-3.09	QP
6	745.519	-0.88	40.07	39.19	46.00	-6.81	Peak

Vertical

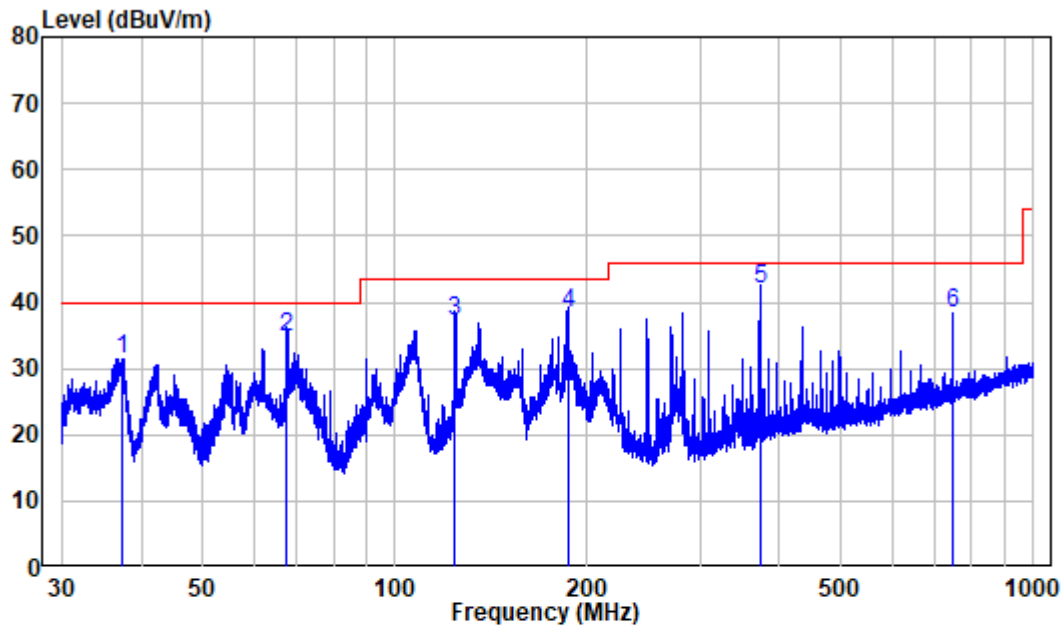

Site : chamber
 Condition: 3m VERTICAL
 Job No. : RA230602-31254E-RF
 Test Mode: Charging+BT Transmitting

	Freq	Factor	Read Level	Limit Level	Over Line	Over Limit	Remark
	MHz	dB/m	dBuV	dBuV/m	dBuV/m	dB	
1	37.367	-10.94	42.43	31.49	40.00	-8.51	Peak
2	67.734	-13.71	48.50	34.79	40.00	-5.21	QP
3	124.187	-14.23	51.40	37.17	43.50	-6.33	QP
4	186.278	-12.02	50.25	38.23	43.50	-5.27	QP
5	372.657	-7.29	49.30	42.01	46.00	-3.99	QP
6	745.193	-0.88	39.25	38.37	46.00	-7.63	Peak

Note: For below 1GHz, when the test result of peak was 6dB below to the limit of QP, just peak value was recorded.

Above 1GHz (Model: MPD621, worst case for 8DPSK):

Frequency (MHz)	Receiver		Turntable Angle Degree	Rx Antenna		Factor (dB/m)	Corrected Amplitude (dBuV/m)	Limit (dBuV/m)	Margin (dB)
	Reading (dBuV)	PK/Ave		Height (m)	Polar (H/V)				
Low Channel									
2310	45.88	PK	136	1.6	H	-10.36	35.52	74	-38.48
2310	47.63	PK	339	1.2	V	-10.36	37.27	74	-36.73
2390	47.05	PK	201	1.6	H	-10.71	36.34	74	-37.66
2390	55.65	PK	194	1.4	V	-10.71	44.94	74	-29.06
4804	58.84	PK	201	1.6	H	-6.11	52.73	74	-21.27
4804	58.94	PK	20	1.7	V	-6.11	49.83	74	-24.17
Middle Channel									
4882	59.05	PK	95	1.9	H	-5.9	53.15	74	-20.85
4882	54.78	PK	121	1.9	V	-5.9	48.88	74	-25.12
High Channel									
2483.5	58.37	PK	220	1.6	H	-10.55	47.82	74	-26.18
2483.5	49.04	PK	85	1.6	V	-10.55	38.49	74	-35.51
2500	48.23	PK	36	1.9	H	-10.42	37.81	74	-36.19
2500	52.51	PK	345	1.5	V	-10.42	42.09	74	-31.91
4960	59.08	PK	36	1.9	H	-5.47	53.61	74	-20.39
4960	58.83	PK	274	1.5	V	-5.47	53.36	74	-20.64

Note:

Factor = Antenna factor (RX) + Cable Loss – Amplifier Factor

Corrected Amplitude = Factor + Reading

Margin = Corrected Amplitude – Limit

Average level= Peak level+ Duty Cycle Corrected Factor

The other spurious emission which is in the noise floor level was not recorded.

For above 1GHz, when the test result of peak was 20dB below to the limit of peak, which can be compliant to the average limit, just peak value was recorded.

1 GHz - 18 GHz: (Pre-Scan plots)

Worst case for 8DPSK, High Channel:

Horizontal

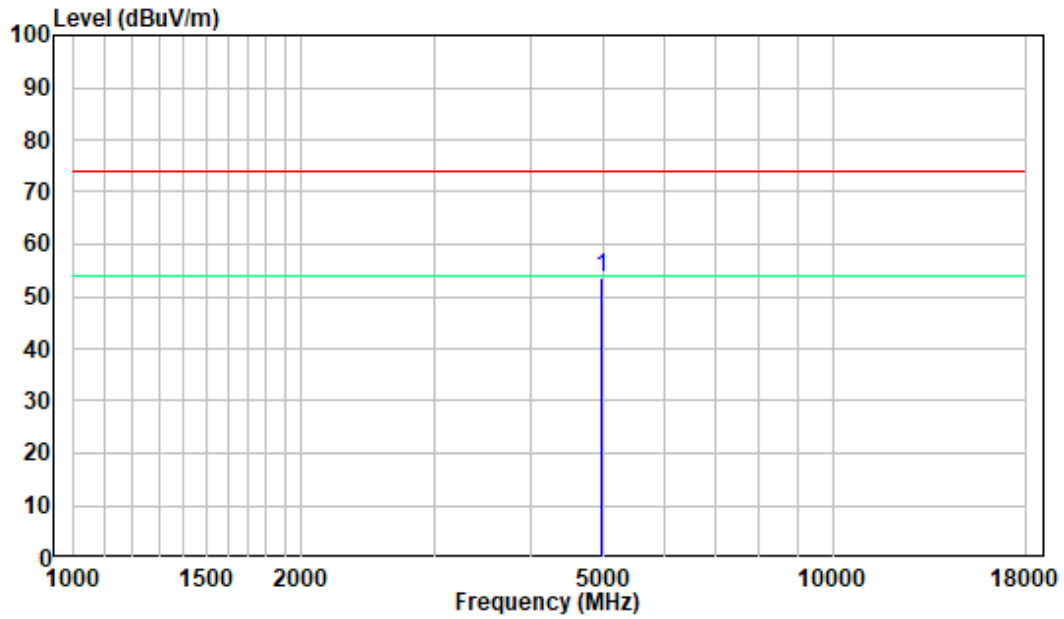

Vertical

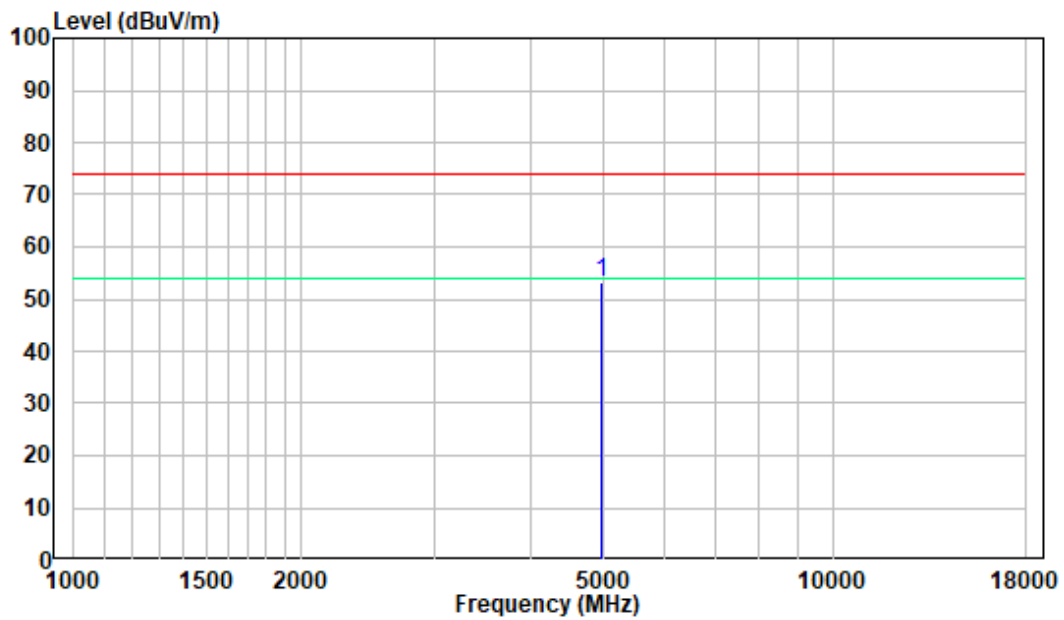

18-25GHz: (Pre-Scan plots)

Worst case for 8DPSK, High Channel:

Horizontal

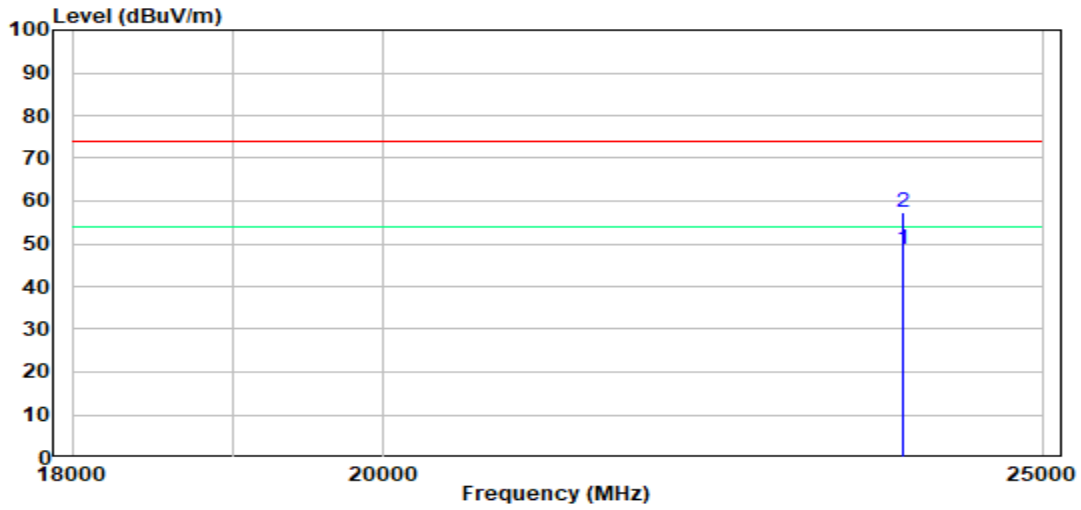

Vertical

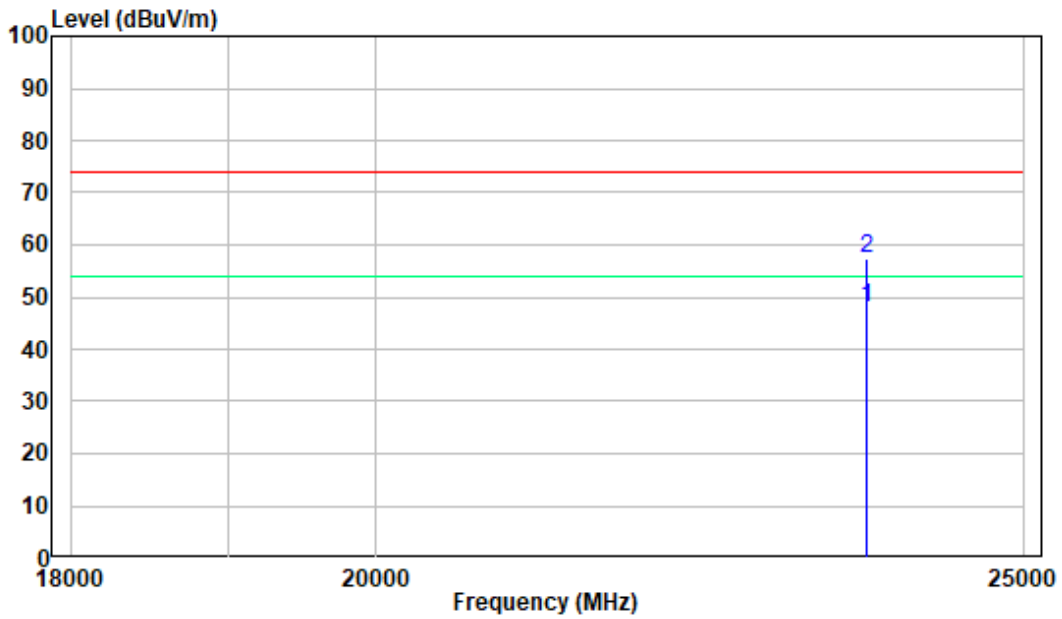

FCC §15.247(a) (1)-CHANNEL SEPARATION TEST

Applicable Standard

Frequency hopping systems shall have hopping channel carrier frequencies separated by a minimum of 25 kHz or the 20 dB bandwidth of the hopping channel, whichever is greater. Alternatively, frequency hopping systems operating in the 2400-2483.5 MHz band may have hopping channel carrier frequencies that are separated by 25 kHz or two-thirds of the 20 dB bandwidth of the hopping channel, whichever is greater provided the systems operate with an output power no greater than 125 mW. The system shall hop to channel frequencies that are selected at the system hopping rate from a pseudo randomly ordered list of hopping frequencies. Each frequency must be used equally on the average by each transmitter. The system receivers shall have input bandwidths that match the hopping channel bandwidths of their corresponding transmitters and shall shift frequencies in synchronization with the transmitted signals.

Test Procedure

According to ANSI C63.10-2013, section 7.8.2

1. Set the EUT in TX mode, maxhold the channel.
2. Set the adjacent channel of the EUT and maxhold another trace.
3. Measure the channel separation.

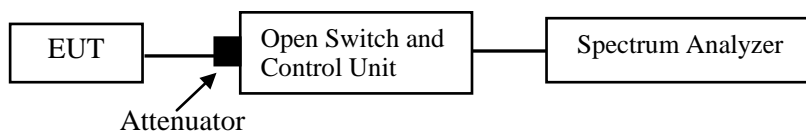

Test Data

Environmental Conditions

Temperature:	25°C
Relative Humidity:	49%
ATM Pressure:	101.0kPa

The testing was performed by Matt Liang on 2023-06-08.

EUT operation mode: Transmitting

Test Result: Compliant. Please refer to the below table and plots:

Test Mode	Antenna	Channel	Result[MHz]	Limit[MHz]	Verdict
DH5	Ant1	Hop	1	≥0.620	PASS
2DH5	Ant1	Hop	1	≥0.860	PASS
3DH5	Ant1	Hop	1.003	≥0.860	PASS

Note: The limit = (2/3) * 20dB bandwidth

DH5_Ant1_Hop

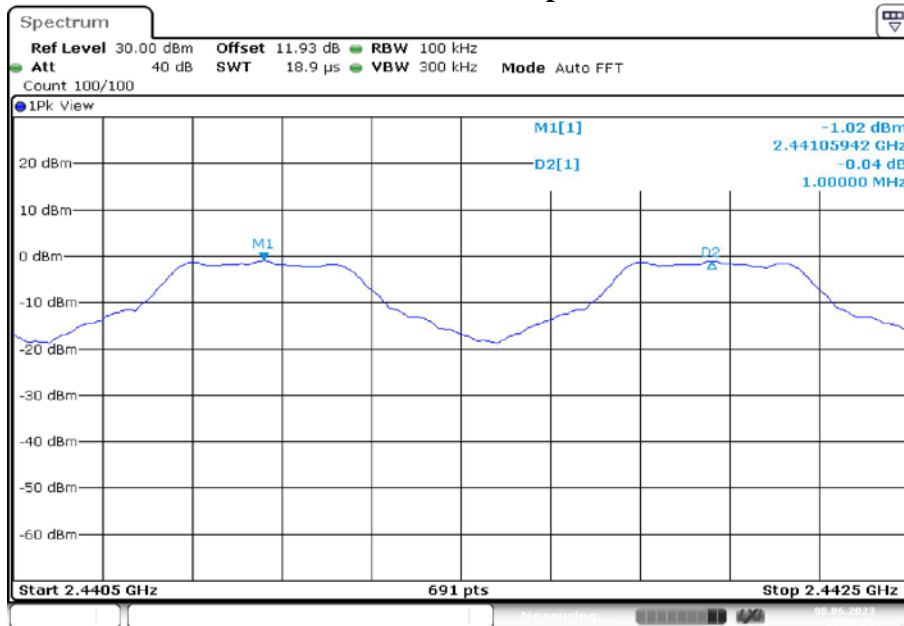

2DH5_Ant1_Hop

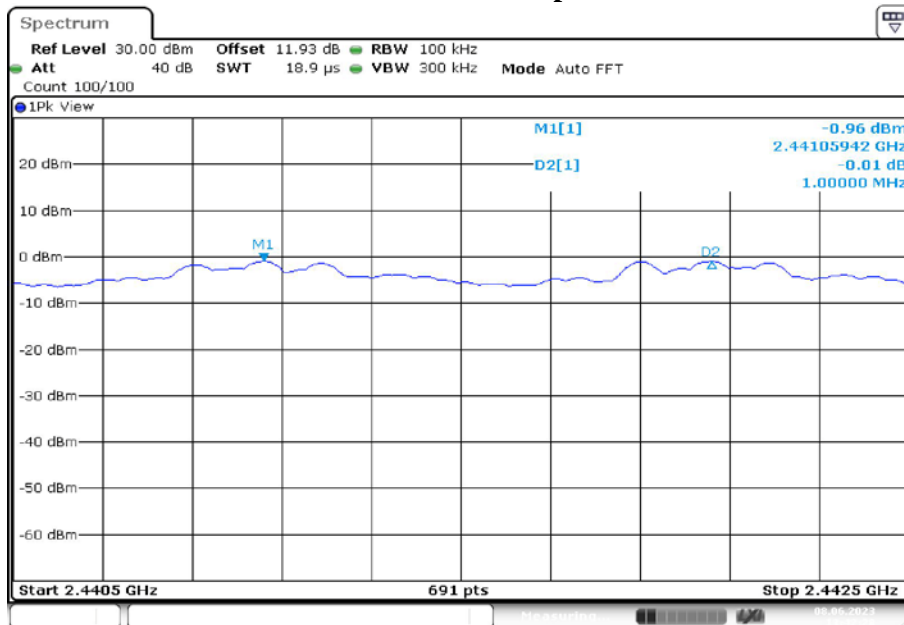

3DH5_Ant1_Hop

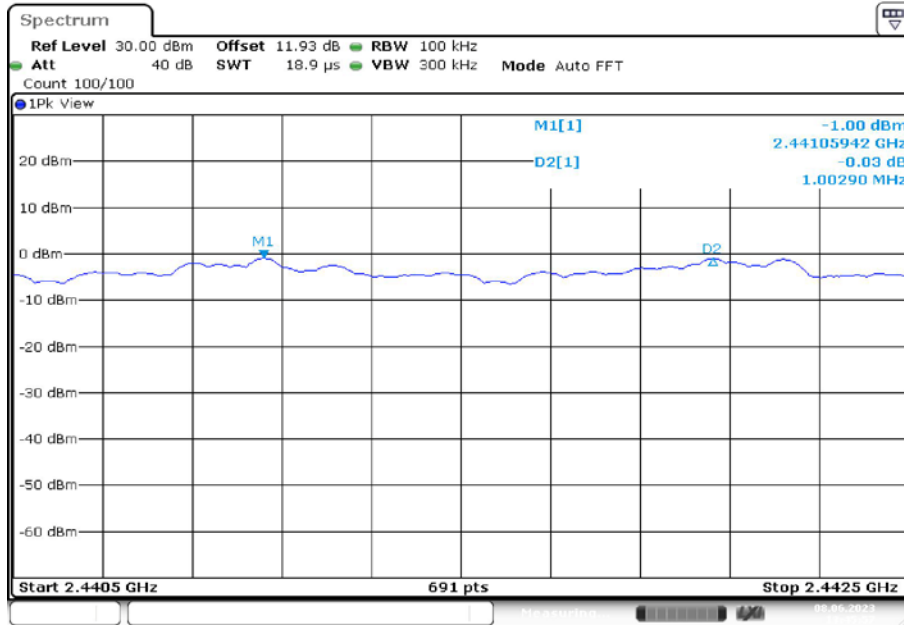

Date: 8.JUN.2023 13:45:57

FCC §15.247(a) (1) – 20 dB EMISSION BANDWIDTH & 99% OCCUPIED BANDWIDTH

Applicable Standard

Alternatively, frequency hopping systems operating in the 2400–2483.5 MHz band may have hopping channel carrier frequencies that are separated by 25 kHz or two-thirds of the 20 dB bandwidth of the hopping channel, whichever is greater, provided the systems operate with an output power no greater than 125 mW.

Test Procedure

According to ANSI C63.10-2013, section 7.8.7 and section 6.9.2

The following conditions shall be observed for measuring the occupied bandwidth and 20 dB bandwidth:

- The transmitter shall be operated at its maximum carrier power measured under normal test conditions.
- The span of the spectrum analyzer shall be set large enough to capture all products of the modulation process, including the emission skirts, around the carrier frequency, but small enough to avoid having other emissions (e.g. on adjacent channels) within the span.
- The detector of the spectrum analyzer shall be set to “Sample”. However, a peak, or peak hold, may be used in place of the sampling detector since this usually produces a wider bandwidth than the actual bandwidth (worst-case measurement). Use of a peak hold (or “Max Hold”) may be necessary to determine the occupied / 20 dB bandwidth if the device is not TX continuously.
- The resolution bandwidth (RBW) shall be in the range of 1% to 5% of the actual occupied / 20 dB bandwidth and the video bandwidth (VBW) shall not be smaller than three times the RBW value. Video averaging is not permitted.

Note: It may be necessary to repeat the measurement a few times until the RBW and VBW are in compliance with the above requirement.

For the 99% emission bandwidth, the trace data points are recovered and directly summed in linear power level terms. The recovered amplitude data points, beginning at the lowest frequency, are placed in a running sum until 0.5% of the total is reached, and that frequency recorded. The process is repeated for the highest frequency data points (starting at the highest frequency, at the right side of the span, and going down in frequency). This frequency is then recorded. The difference between the two recorded frequencies is the occupied bandwidth (or the 99% emission bandwidth).

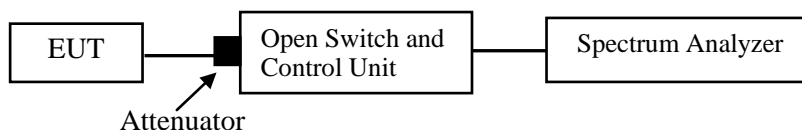

Test Data**Environmental Conditions**

Temperature:	25°C
Relative Humidity:	49%
ATM Pressure:	101.0kPa

The testing was performed by Matt Liang on 2023-06-08.

EUT operation mode: Transmitting

Test Result: Compliant. Please refer to the below table and plots:

Test Mode	Antenna	Channel	20db EBW[MHz]	OCB [MHz]	Verdict
DH5	Ant1	2402	0.93	0.863	PASS
		2441	0.93	0.863	PASS
		2480	0.93	0.866	PASS
2DH5	Ant1	2402	1.29	1.178	PASS
		2441	1.29	1.175	PASS
		2480	1.29	1.175	PASS
3DH5	Ant1	2402	1.29	1.199	PASS
		2441	1.29	1.199	PASS
		2480	1.29	1.196	PASS

20 dB EMISSION BANDWIDTH_DH5_Ant1_2402

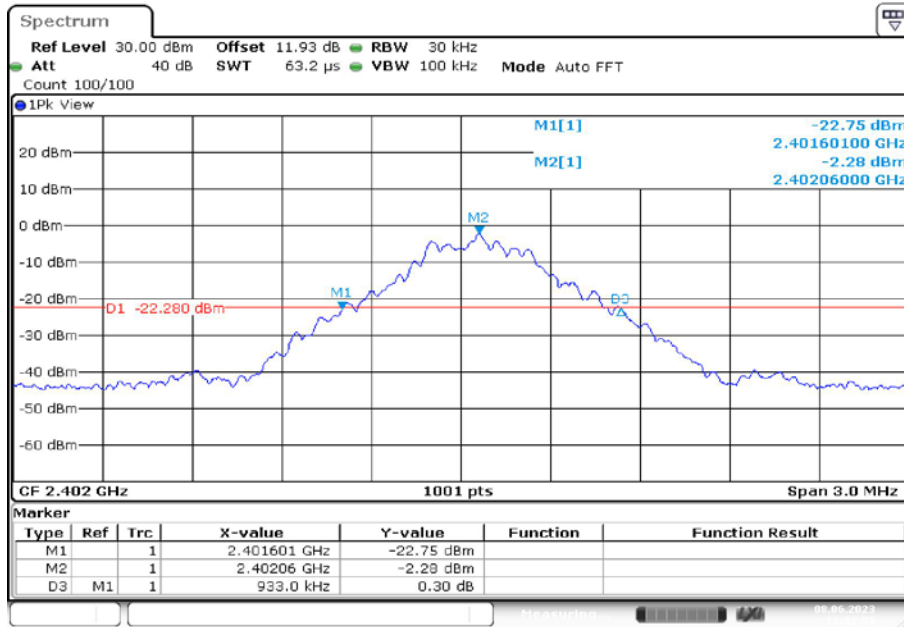

Date: 8.JUN.2023 13:32:59

99% OCCUPIED BANDWIDTH_DH5_Ant1_2402

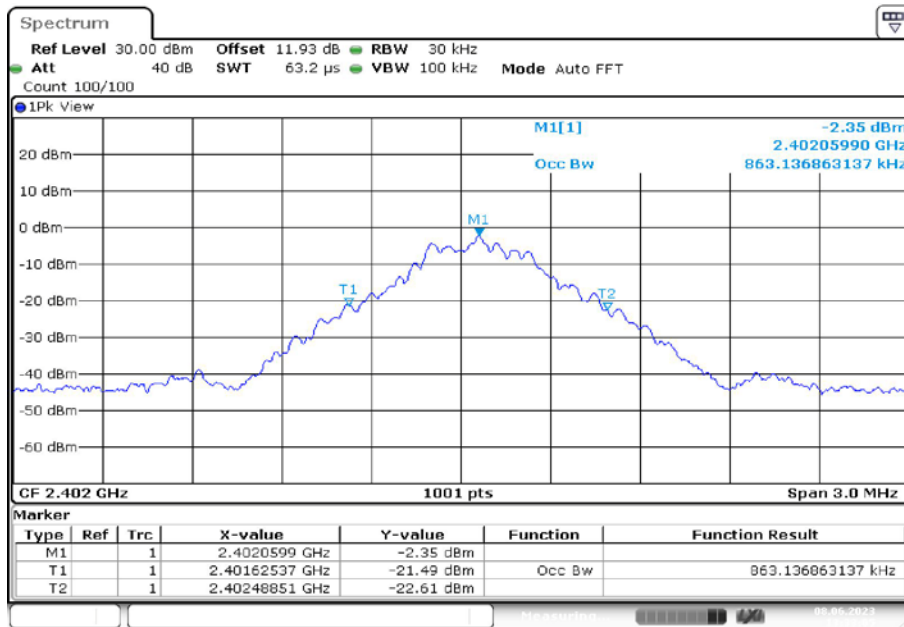

Date: 8.JUN.2023 13:33:05

20 dB EMISSION BANDWIDTH_DH5_Ant1_2441

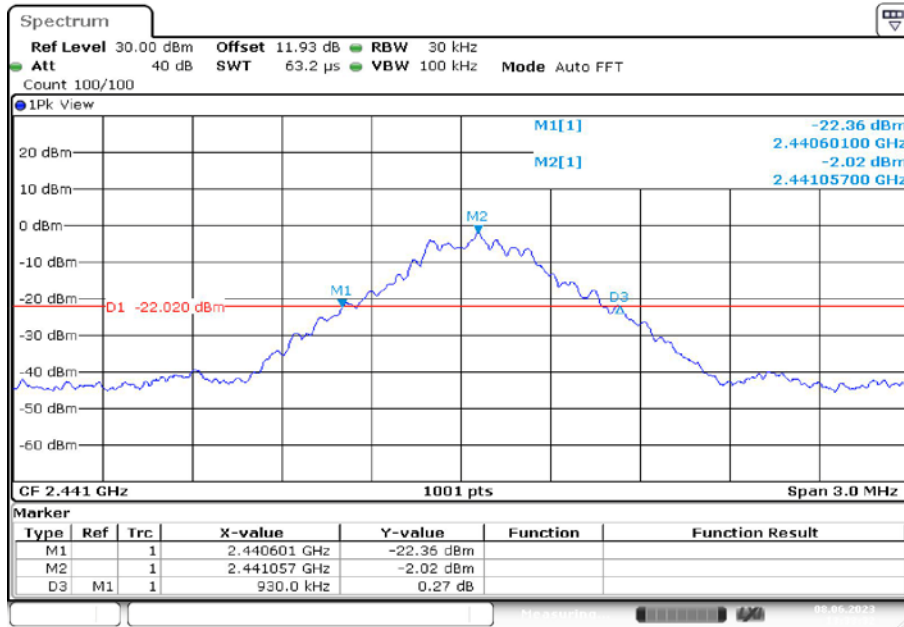

Date: 8.JUN.2023 13:33:32

99% OCCUPIED BANDWIDTH_DH5_Ant1_2441

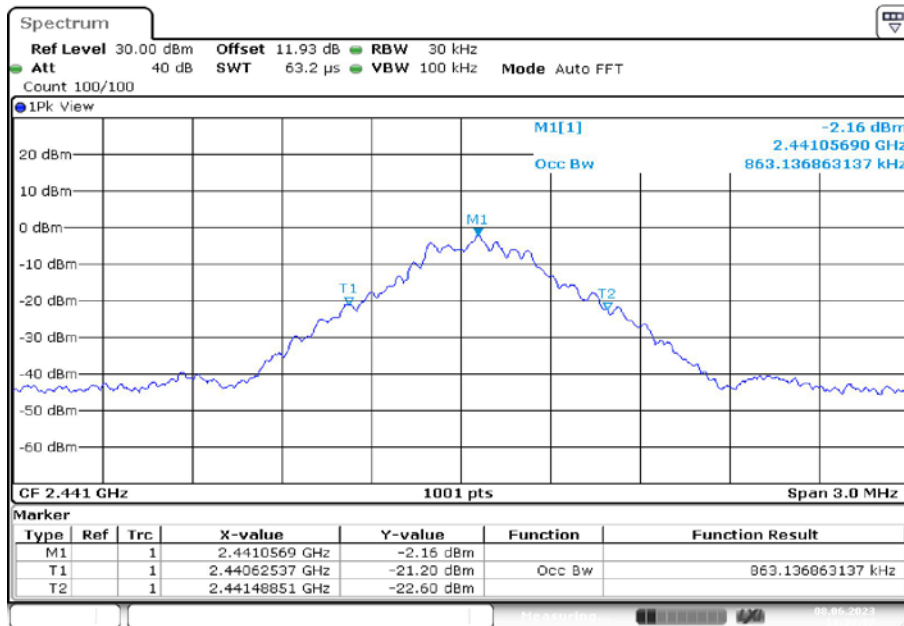

Date: 8.JUN.2023 13:33:37

20 dB EMISSION BANDWIDTH_DH5_Ant1_2480

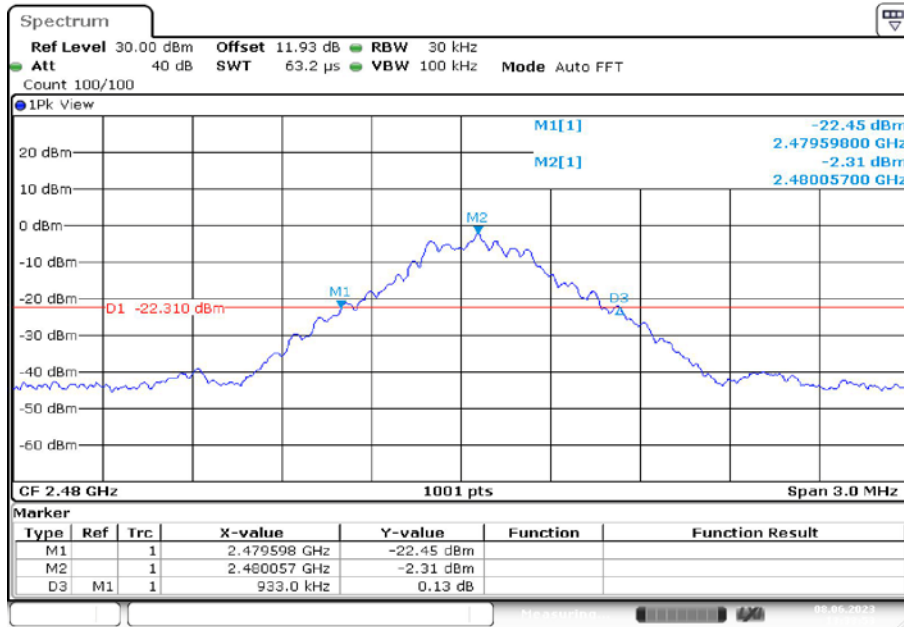

Date: 8.JUN.2023 13:33:53

99% OCCUPIED BANDWIDTH_DH5_Ant1_2480

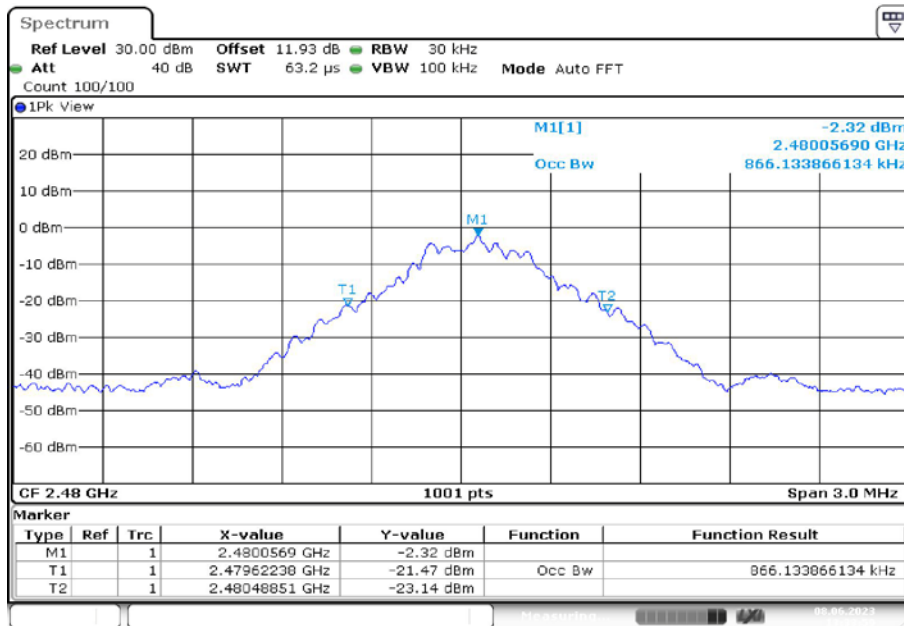

Date: 8.JUN.2023 13:33:59

20 dB EMISSION BANDWIDTH_2DH5_Ant1_2402

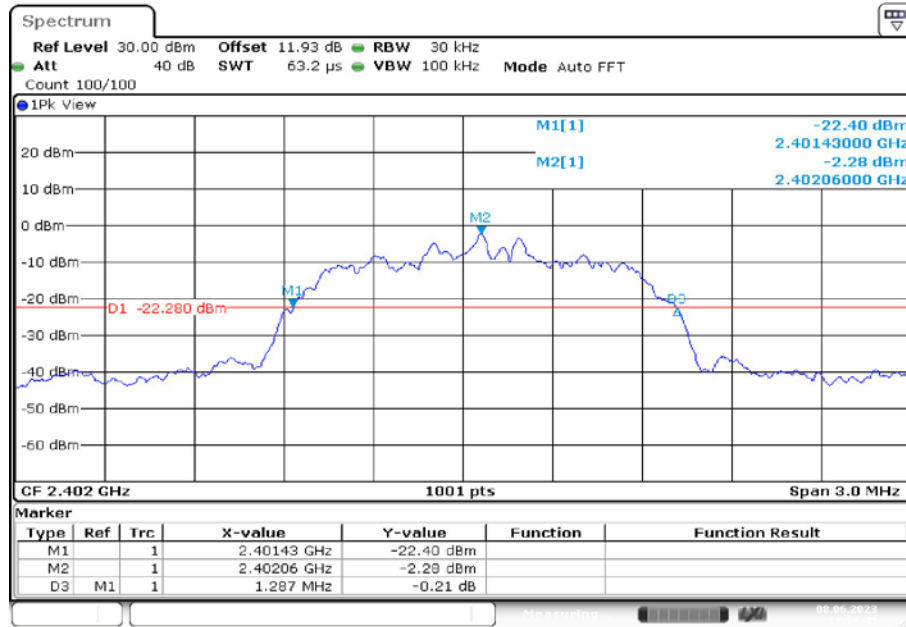

Date: 8.JUN.2023 13:34:45

99% OCCUPIED BANDWIDTH_2DH5_Ant1_2402

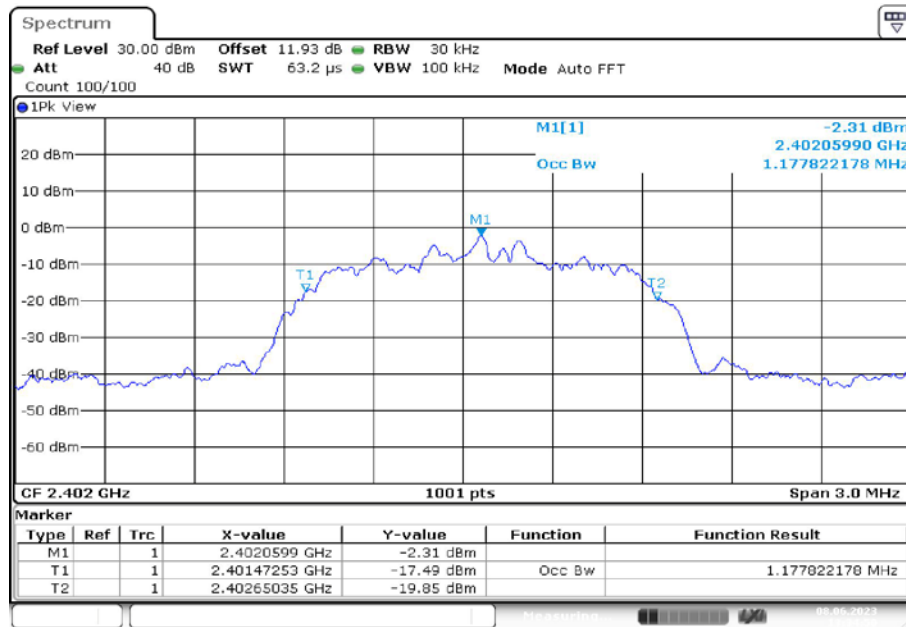

Date: 8.JUN.2023 13:34:50

20 dB EMISSION BANDWIDTH_2DH5_Ant1_2441

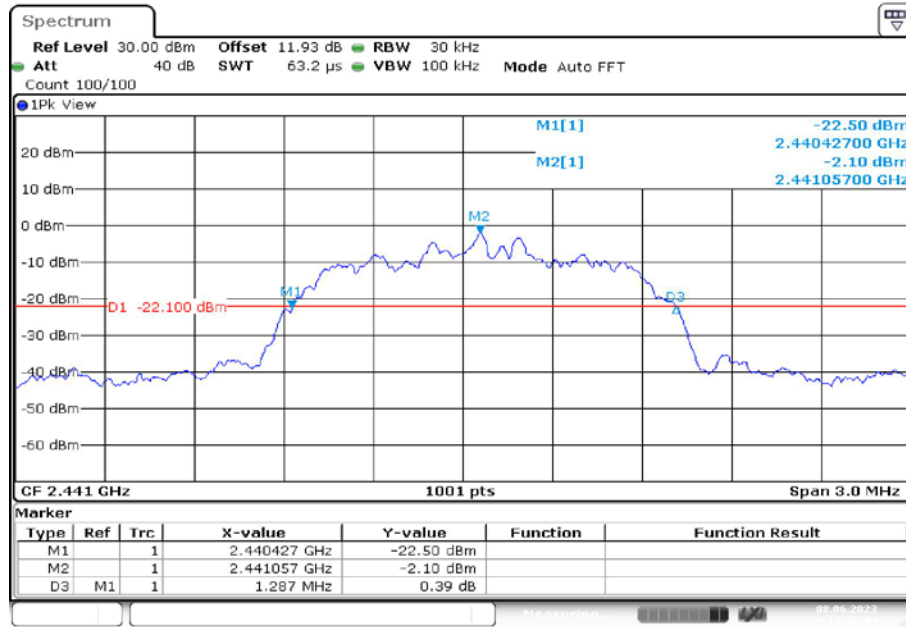

Date: 8.JUN.2023 13:35:34

99% OCCUPIED BANDWIDTH_2DH5_Ant1_2441

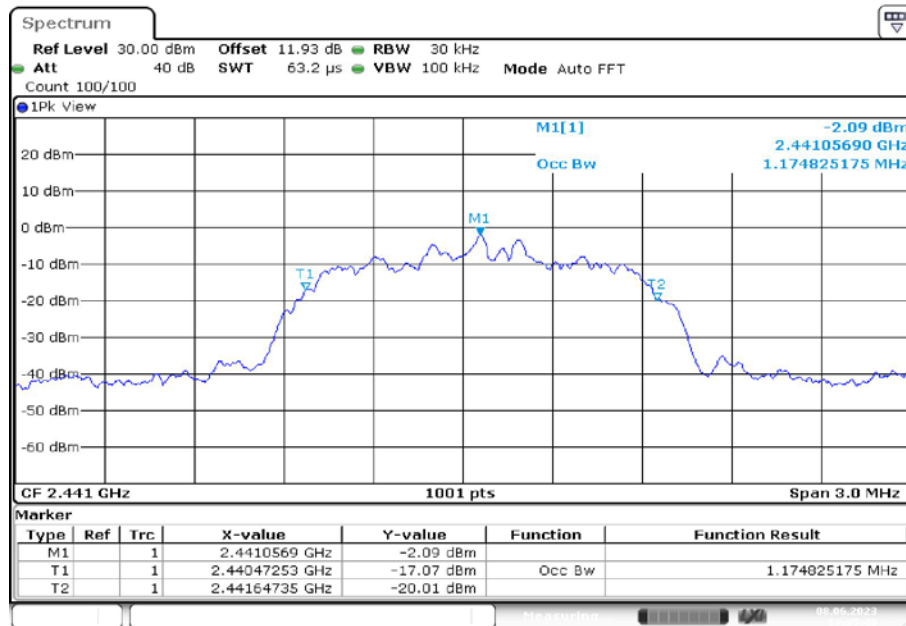

Date: 8.JUN.2023 13:35:40

20 dB EMISSION BANDWIDTH _2DH5_Ant1_2480

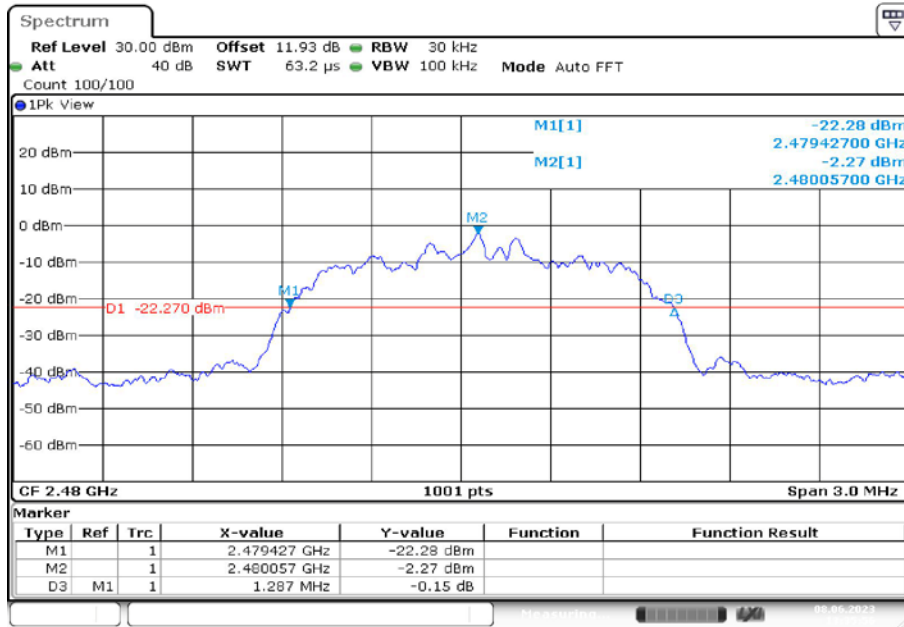

Date: 8.JUN.2023 13:35:56

99% OCCUPIED BANDWIDTH _2DH5_Ant1_2480

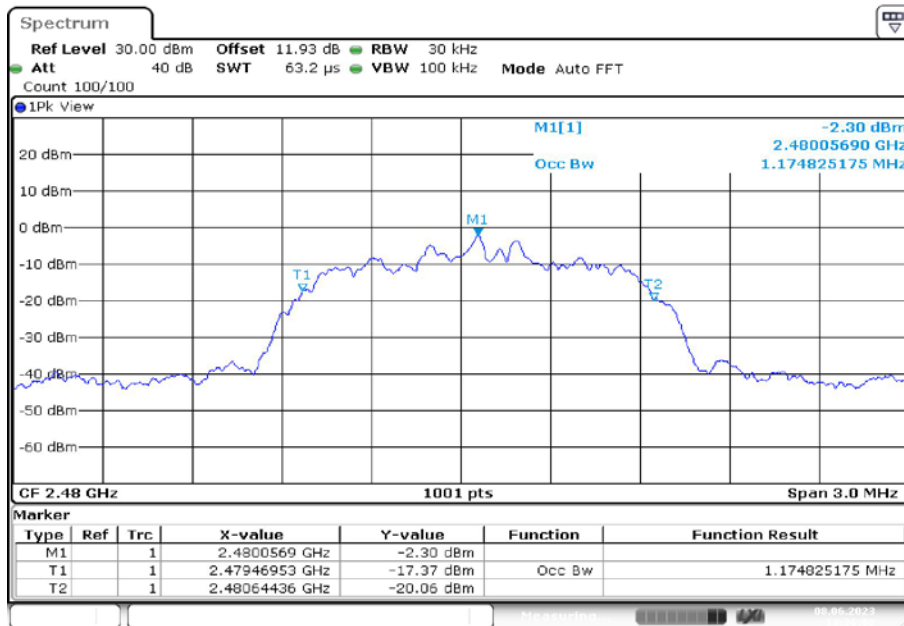

Date: 8.JUN.2023 13:36:02

20 dB EMISSION BANDWIDTH _3DH5_Ant1_2402

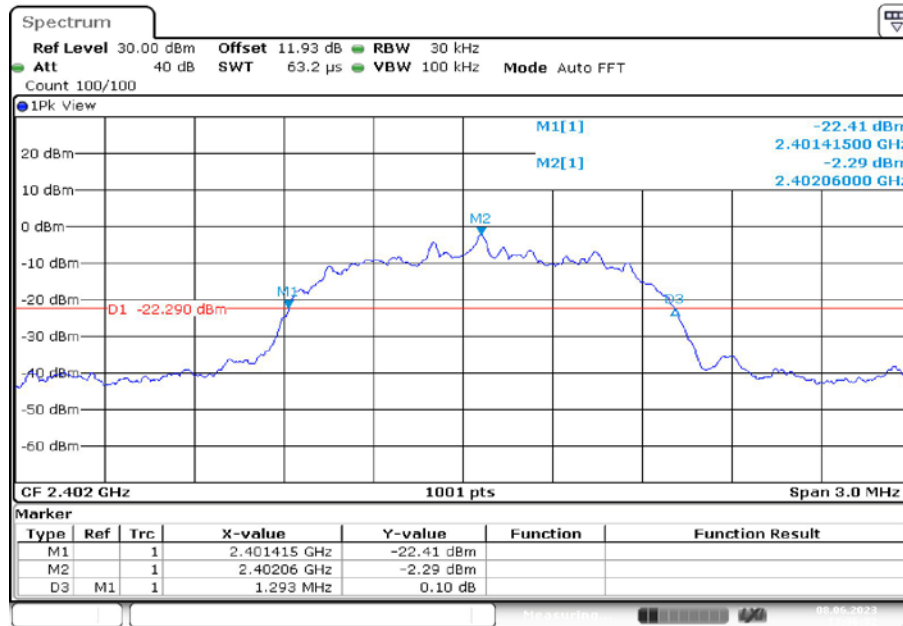

Date: 8.JUN.2023 13:36:32

99% OCCUPIED BANDWIDTH _3DH5_Ant1_2402

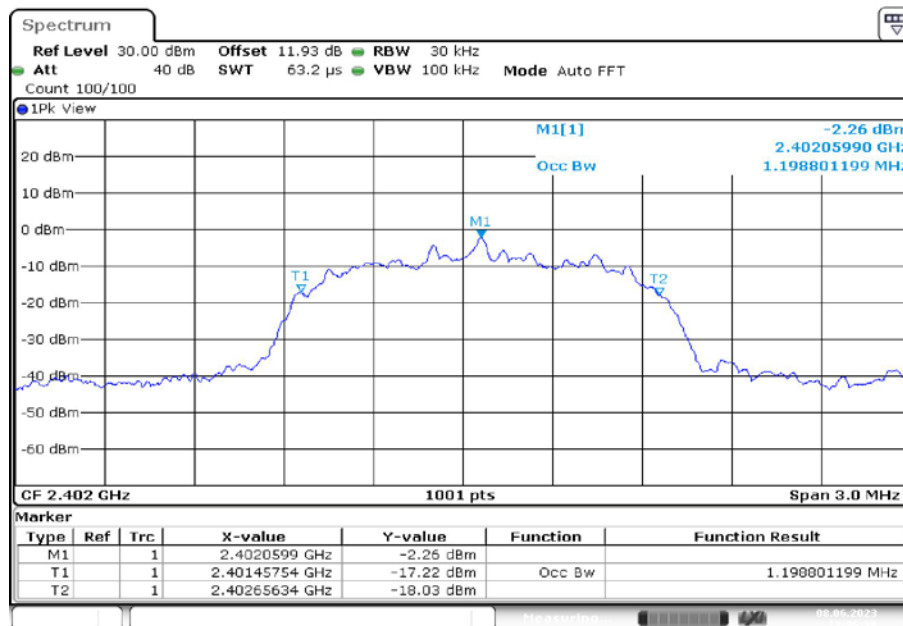

Date: 8.JUN.2023 13:36:38

20 dB EMISSION BANDWIDTH _3DH5_Ant1_2441

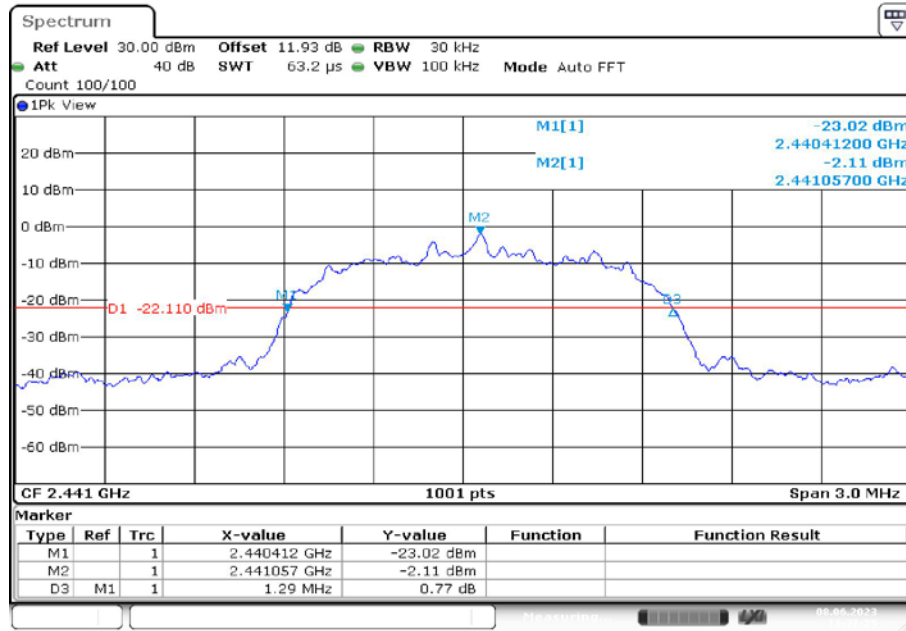

99% OCCUPIED BANDWIDTH _3DH5_Ant1_2441

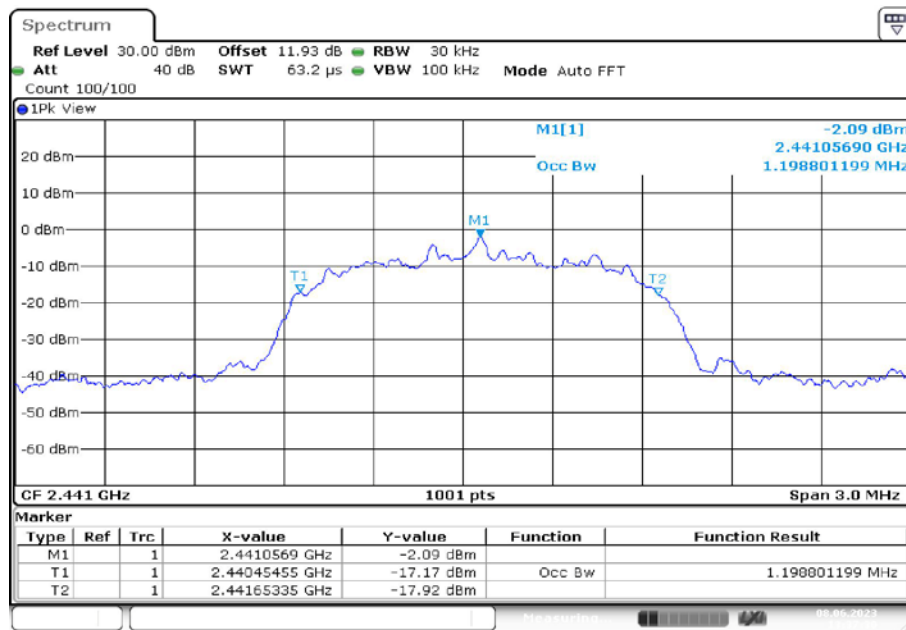

20 dB EMISSION BANDWIDTH _3DH5_Ant1_2480

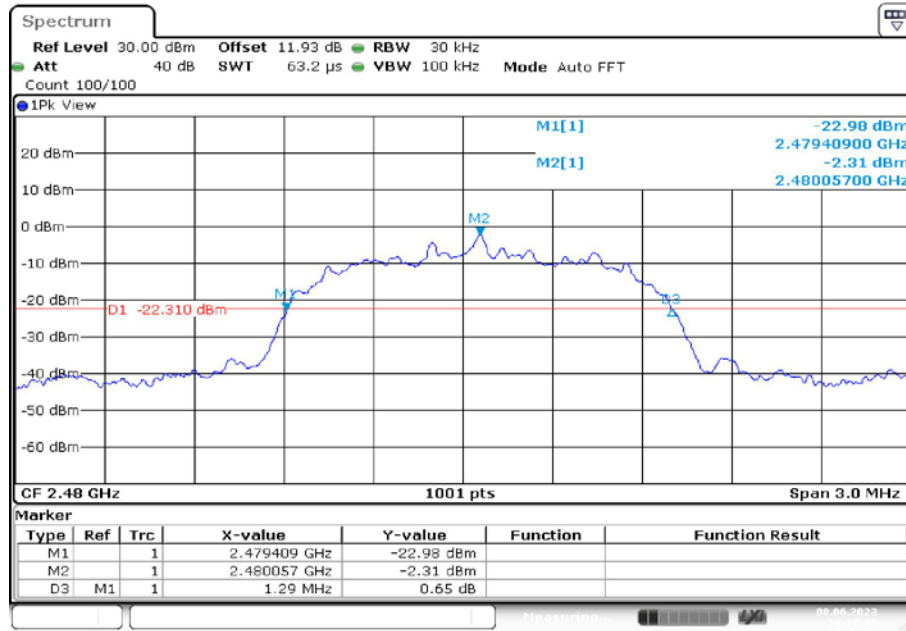

Date: 8.JUN.2023 13:37:55

99% OCCUPIED BANDWIDTH _3DH5_Ant1_2480

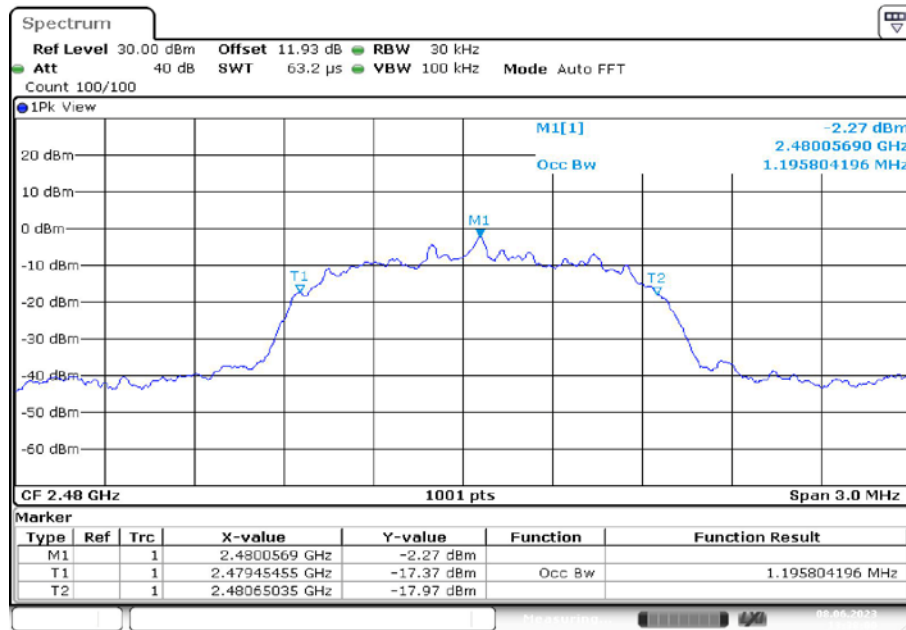

Date: 8.JUN.2023 13:38:00

FCC §15.247(a) (1) (iii)-QUANTITY OF HOPPING CHANNEL TEST

Applicable Standard

Frequency hopping systems in the 2400–2483.5 MHz band shall use at least 15 channels. The average time of occupancy on any channel shall not be greater than 0.4 seconds within a period of 0.4 seconds multiplied by the number of hopping channels employed. Frequency hopping systems may avoid or suppress transmissions on a particular hopping frequency provided that a minimum of 15 channels are used.

Test Procedure

According to ANSI C63.10-2013, section 7.8.3

1. Check the calibration of the measuring instrument (SA) using either an internal calibrator or a known signal from an external generator.
2. Set the EUT in hopping mode from first channel to last.
3. By using the max-hold function record the quantity of the channel.

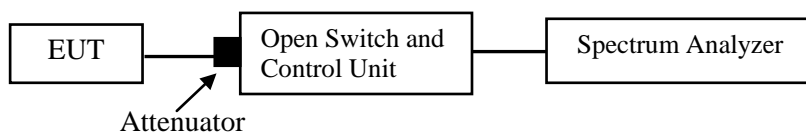

Test Data

Environmental Conditions

Temperature:	25°C
Relative Humidity:	49%
ATM Pressure:	101.0kPa

The testing was performed by Matt Liang on 2023-06-08.

EUT operation mode: Transmitting

Test Result: Compliant. Please refer to the below table and plots:

Test Mode	Antenna	Channel	Result[Num]	Limit[Num]	Verdict
DH5	Ant1	Hop	79	>=15	PASS
2DH5	Ant1	Hop	79	>=15	PASS
3DH5	Ant1	Hop	79	>=15	PASS

DH5_Ant1_Hop

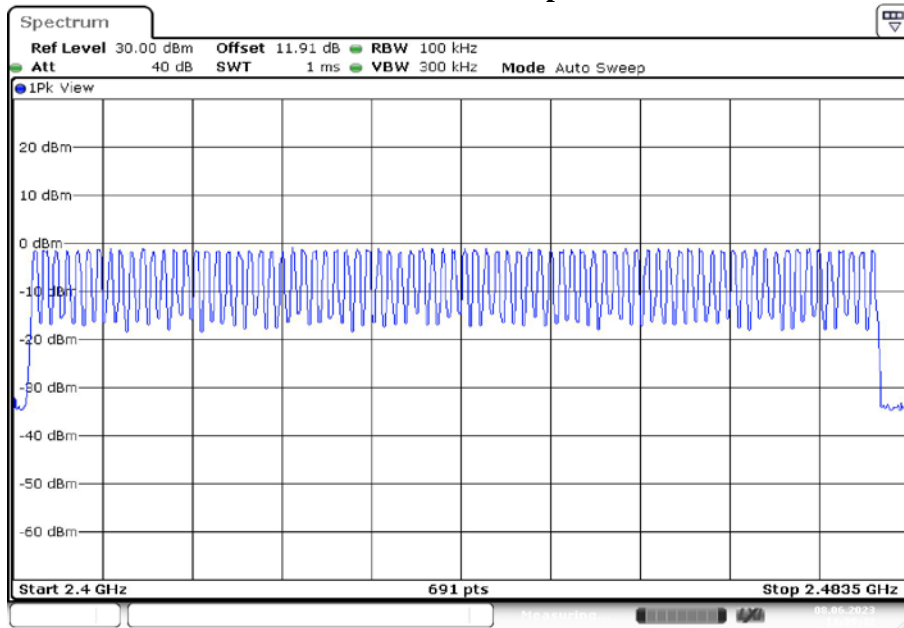

Date: 8 JUN.2023 13:39:42

2DH5_Ant1_Hop

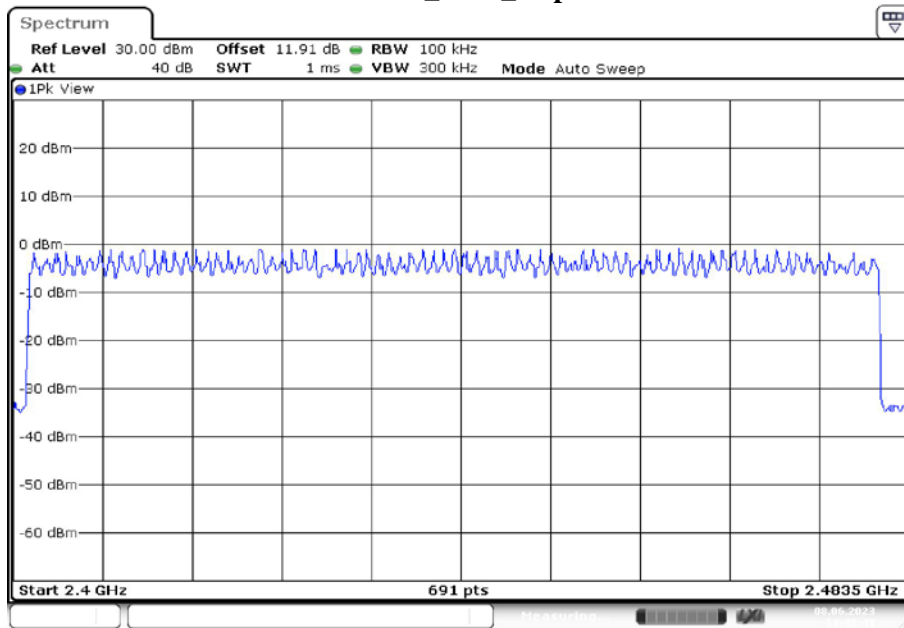

Date: 8 JUN.2023 13:42:41

3DH5_Ant1_Hop

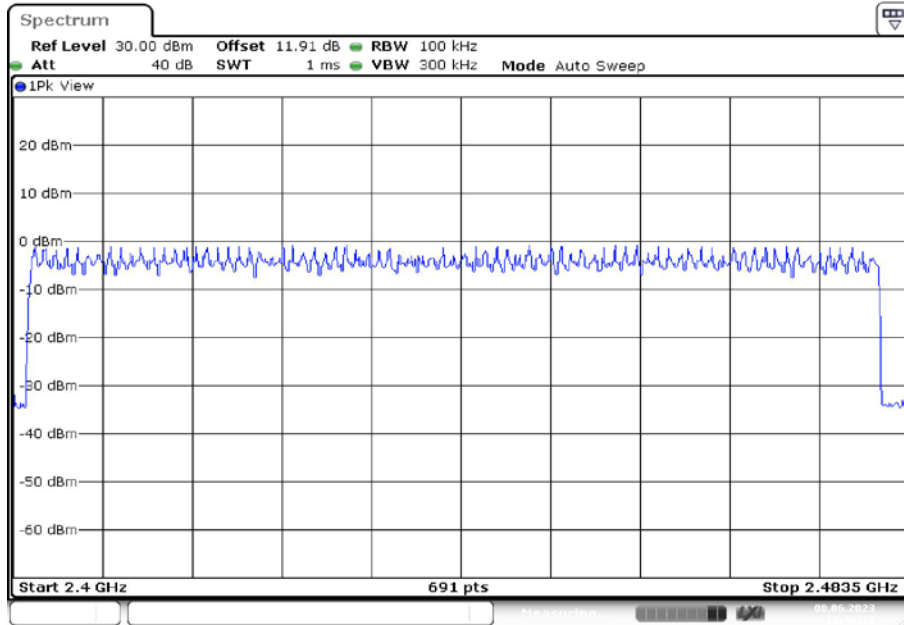

Date: 8.JUN.2023 13:46:11