



**中认信通**  
CHINA CERTIFICATION ICT CO., LTD (DONGGUAN)



## SAR TEST REPORT

**Applicant: CHITECH SHENZHEN TECHNOLOGY CO.,LTD**

Address: 101,NO.48,Xiashijia Road,Gongming Town,Guangming Dist.,Shenzhen,China

**FCC ID: 2AXUI-W120**

**Product Name: Tablet PC**

**Tested Model: W120**

**Multiple Models: F39WQ, F39W, W310, W320, W510, W520**

**Trade Name: TIBUTA**

**Standard(s): 47 CFR Part 2(2.1093)**

The above device has been tested and found compliant with the requirement of the relative standards by China Certification ICT Co., Ltd (Dongguan)

**Report Number: CR230952638-20**

**Date Of Issue: 2023-10-13**

**Reviewed By: Karl Gong**

*Karl Gong*

Title: SAR Engineer

**Test Laboratory: China Certification ICT Co., Ltd (Dongguan)**

No. 113, Pingkang Road, Dalang Town, Dongguan,  
Guangdong, China  
Tel: +86-769-82016888

**SAR TEST RESULTS SUMMARY**

Operation Frequency Bands	Highest Reported 1g SAR (W/kg)	Limits (W/kg)
	Body-Supported (0mm)	
WLAN 2.4G	0.6	1.6
WLAN 5.2G	0.55	
WLAN 5.8G	1.44	
Maximum Simultaneous Transmission SAR		
Items	Body-Supported (0mm)	Limits
Sum SAR(W/kg)	N/A	1.6
SPLSR	N/A	0.04
EUT Received Date:	2023/09/11	
Tested Date:	2023/09/27	
Tested Result:	Pass	

## Test Facility

The Test site used by China Certification ICT Co., Ltd (Dongguan) to collect test data is located on the No. 113, Pingkang Road, Dalang Town, Dongguan, Guangdong, China.

The lab has been recognized as the FCC accredited lab under the KDB 974614 D01 and is listed in the FCC Public Access Link (PAL) database, FCC Registration No. : 442868, the FCC Designation No. : CN1314.

The lab has been recognized by Innovation, Science and Economic Development Canada to test to Canadian radio equipment requirements, the CAB identifier: CN0123.

## Declarations

China Certification ICT Co., Ltd (Dongguan) is not responsible for the authenticity of any test data provided by the applicant. Data included from the applicant that may affect test results are marked with a triangle symbol “▲”. Customer model name, addresses, names, trademarks etc. are not considered data.

Unless otherwise stated the results shown in this test report refer only to the sample(s) tested.

This report cannot be reproduced except in full, without prior written approval of the Company.

This report is valid only with a valid digital signature. The digital signature may be available only under the Adobe software above version 7.0.

This report may contain data that are not covered by the accreditation scope and shall be marked with an asterisk “★”.

## CONTENTS

<b>DOCUMENT REVISION HISTORY .....</b>	<b>6</b>
<b>1. GENERAL INFORMATION .....</b>	<b>7</b>
1.1 PRODUCT DESCRIPTION FOR DEVICE UNDER TEST (EUT) .....	7
1.2 TEST SPECIFICATION, METHODS AND PROCEDURES .....	8
1.3 SAR LIMITS.....	9
1.4 FACILITIES.....	10
<b>2. SAR MEASUREMENT SYSTEM .....</b>	<b>11</b>
<b>3. EQUIPMENT LIST AND CALIBRATION .....</b>	<b>18</b>
3.1 EQUIPMENTS LIST & CALIBRATION INFORMATION .....	18
<b>4. SAR MEASUREMENT SYSTEM VERIFICATION .....</b>	<b>19</b>
4.1 LIQUID VERIFICATION .....	19
4.2 SYSTEM ACCURACY VERIFICATION .....	21
4.3 SAR SYSTEM VALIDATION DATA.....	22
<b>5. EUT TEST STRATEGY AND METHODOLOGY .....</b>	<b>25</b>
5.1 TEST POSITIONS FOR BODY-WORN AND OTHER CONFIGURATIONS .....	25
5.2 TEST DISTANCE FOR SAR EVALUATION.....	25
5.3 SAR EVALUATION PROCEDURE .....	26
<b>6. CONDUCTED OUTPUT POWER MEASUREMENT .....</b>	<b>27</b>
6.1 TEST PROCEDURE.....	27
6.2 MAXIMUM TARGET OUTPUT POWER.....	27
6.3 TEST RESULTS: .....	28
<b>7. Standalone SAR test exclusion considerations .....</b>	<b>30</b>
7.1 ANTENNA DISTANCE TO EDGE .....	30
7.2 STANDALONE SAR TEST EXCLUSION CONSIDERATIONS .....	30
7.3 STANDALONE SAR ESTIMATION: .....	31
7.4 STANDALONE SAR TEST EXCLUSION CONSIDERATIONS:.....	31
7.5 SAR TEST EXCLUSION FOR THE EUT EDGE CONSIDERATIONS RESULT .....	31
<b>8. SAR MEASUREMENT RESULTS .....</b>	<b>33</b>
8.1 SAR TEST DATA .....	33
<b>9. Measurement Variability .....</b>	<b>36</b>
<b>10. SAR Plots .....</b>	<b>37</b>

**APPENDIX A MEASUREMENT UNCERTAINTY ..... 48**  
**APPENDIX B EUT TEST POSITION PHOTOS ..... 50**  
**APPENDIX C CALIBRATION CERTIFICATES ..... 51**

## DOCUMENT REVISION HISTORY

Revision Number	Report Number	Description of Revision	Date of Revision
1.0	CR230952638-20	Original Report	2023-10-13

## 1. GENERAL INFORMATION

### 1.1 Product Description for device under Test (EUT)

<b>Device Type:</b>	Portable
<b>Exposure Category:</b>	Population / Uncontrolled
<b>Antenna Type(s):</b>	Internal Antenna
<b>Body-Worn Accessories:</b>	None
<b>Operation modes:</b>	WLAN and Bluetooth
<b>Frequency Band:</b>	WLAN 2.4G : 2412 MHz-2462 MHz/2422-2452 MHz WLAN 5.2G : 5150 MHz-5250 MHz WLAN 5.8G : 5725 MHz-5850 MHz Bluetooth : 2402 MHz-2480 MHz
<b>Conducted RF Average Power:</b>	WLAN 2.4G: 13.75 dBm WLAN 5.2G: 13.32 dBm WLAN 5.8G: 13.56 dBm Bluetooth(BDR/EDR): 4.49 dBm BLE: -2.69 dBm
<b>Dimensions (L*W*H):</b>	248 mm (L) * 166 mm (W) * 10 mm (H)
<b>Rated Input Voltage:</b>	DC 7.6 V from Rechargeable Battery
<b>Serial Number:</b>	2B1J-1
<b>Normal Operation:</b>	Body Supported

*Note: The Multiple models are electrically identical with the test model. They are the same product, and just the different model name. Please refer to the declaration letter for more detail, which was provided by manufacturer.*

## **1.2 Test Specification, Methods and Procedures**

The tests documented in this report were performed in accordance with FCC 47 CFR § 2.1093, IEEE 1528-2013, the following FCC Published RF exposure KDB procedures:

KDB 447498 D01 General RF Exposure Guidance v06  
KDB 865664 D01 SAR Measurement 100 MHz to 6 GHz v01r04  
KDB 865664 D02 RF Exposure Reporting v01r02  
KDB 616217 D04 SAR for laptop and tablets v01r02  
KDB 248227 D01 802.11 Wi-Fi SAR v02r02

TCB Workshop April 2019: RF Exposure Procedures



**1.3 SAR Limits****FCC Limit**

<b>EXPOSURE LIMITS</b>	<b>SAR (W/kg)</b>	
	(General Population / Uncontrolled Exposure Environment)	(Occupational / Controlled Exposure Environment)
Spatial Average (averaged over the whole body)	0.08	0.4
Spatial Peak (averaged over any 1 g of tissue)	<b>1.60</b>	8.0
Spatial Peak (hands/wrists/feet/ankles averaged over 10 g)	4.0	20.0

Population/Uncontrolled Environments are defined as locations where there is the exposure of individual who have no knowledge or control of their exposure.

Occupational/Controlled Environments are defined as locations where there is exposure that may be incurred by people who are aware of the potential for exposure (i.e. as a result of employment or occupation).

General Population/Uncontrolled environments Spatial Peak limit 1.6W/kg for 1g SAR applied to the EUT.

## 1.4 FACILITIES

The Test site used by China Certification ICT Co., Ltd (Dongguan) to collect test data is located on the No. 113, Pingkang Road, Dalang Town, Dongguan, Guangdong, China.

The test sites and measurement facilities used to collect data are located at:

<input type="checkbox"/> SAR Lab 1	<input checked="" type="checkbox"/> SAR Lab 2
------------------------------------	---

## 2. SAR MEASUREMENT SYSTEM

These measurements were performed with the automated near-field scanning system DASY5 from Schmid & Partner Engineering AG (SPEAG) which is the Fifth generation of the system shown in the figure hereinafter:



### DASY5 System Description

The DASY5 system for performing compliance tests consists of the following items:

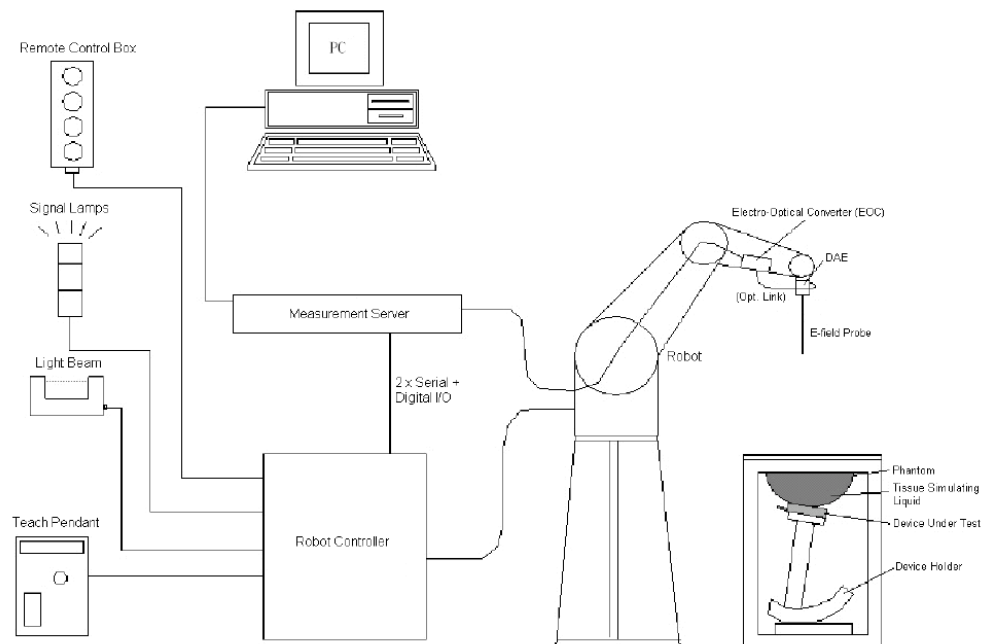

- A standard high precision 6-axis robot with controller, teach pendant and software. An arm extension for accommodating the data acquisition electronics (DAE).
- An isotropic field probe optimized and calibrated for the targeted measurement.
- A data acquisition electronics (DAE) which performs the signal application, signal multiplexing, AD-conversion, offset measurements, mechanical surface detection, collision detection, etc. The unit is battery powered with standard or rechargeable batteries. The signal is optically transmitted to the EOC.
- The Electro-optical converter (EOC) performs the conversion from optical to electrical signals for the digital communication to the DAE. To use optical surface detection, a special version of the EOC is required. The EOC signal is transmitted to the measurement server.
- The function of the measurement server is to perform the time critical tasks such as signal filtering, control of the robot operation and fast movement interrupts.
- The Light Beam used is for probe alignment. This improves the (absolute) accuracy of the probe positioning.
- A computer running Win7 professional operating system and the DASY52 software.
- Remote control and teach pendant as well as additional circuitry for robot safety such as warning lamps, etc.
- The phantom, the device holder and other accessories according to the targeted measurement.

### **DASY5 Measurement Server**

The DASY5 measurement server is based on a PC/104 CPU board with a 400MHz Intel ULV Celeron, 128MB chip-disk and 128MB RAM. The necessary circuits for communication with the DAE4 (or DAE3) electronics box, as well as the 16 bit AD-converter system for optical detection and digital I/O interface are contained on the DASY5 I/O board, which is directly connected to the PC/104 bus of the CPU board.



The measurement server performs all real-time data evaluation of field measurements and surface detection, controls robot movements and handles safety operation. The PC operating system cannot interfere with these time critical processes. All connections are supervised by a watchdog, and disconnection of any of the cables to the measurement server will automatically disarm the robot and disable all program-controlled robot movements. Furthermore, the measurement server is equipped with an expansion port which is reserved for future applications. Please note that this expansion port does not have a standardized point out, and therefore only devices provided by SPEAG can be connected. Devices from any other supplier could seriously damage the measurement server.

### **Data Acquisition Electronics**

The data acquisition electronics (DAE4) consist of a highly sensitive electrometer-grade preamplifier with auto-zeroing, a channel and gain-switching multiplexer, a fast 16 bit AD-converter and a command decoder with a control logic unit. Transmission to the measurement server is accomplished through an optical downlink for data and status information, as well as an optical uplink for commands and the clock.

The mechanical probe mounting device includes two different sensor systems for frontal and sideways probe contacts. They are used for mechanical surface detection and probe collision detection.

The input impedance of both the DAE4 as well as of the DAE3 box is 200M $\Omega$ ; the inputs are symmetrical and floating. Common mode rejection is above 80 dB.

**EX3DV4 E-Field Probes**

<b>Frequency</b>	4 MHz to 10 GHz Linearity: $\pm 0.2$ dB (30 MHz to 10 GHz)
<b>Directivity</b>	$\pm 0.1$ dB in TSL (rotation around probe axis) $\pm 0.3$ dB in TSL (rotation normal to probe axis)
<b>Dynamic Range</b>	10 $\mu$ W/g to > 100 mW/g Linearity: $\pm 0.2$ dB (noise: typically < 1 $\mu$ W/g)
<b>Dimensions</b>	Overall length: 337 mm (Tip: 20 mm) Tip diameter: 2.5 mm (Body: 12 mm) Typical distance from probe tip to dipole centers: 1 mm
<b>Application</b>	High precision dosimetric measurements in any exposure scenario (e.g., very strong gradient fields); the only probe that enables compliance testing for frequencies up to 6 GHz with precision of better 30%.
<b>Compatibility</b>	DASY3, DASY4, DASY52, DASY6, DASY8 SAR, EASY6, EASY4/MRI

**Calibration Frequency Points for EX3DV4 E-Field Probes SN: 7522 Calibrated: 2023/5/29**

Calibration Frequency Point(MHz)	Frequency Range(MHz)		Conversion Factor		
	From	To	X	Y	Z
750 Head	650	850	9.90	9.90	9.90
900 Head	850	1000	9.37	9.37	9.37
1750 Head	1650	1850	8.15	8.15	8.15
1900 Head	1850	2000	7.94	7.94	7.94
2300 Head	2200	2400	7.67	7.67	7.67
2450 Head	2400	2550	7.42	7.42	7.42
2600 Head	2550	2700	7.23	7.23	7.23
5250 Head	5140	5360	5.36	5.36	5.36
5500 Head	5390	5610	4.85	4.85	4.85
5750 Head	5640	5860	4.90	4.90	4.90

### **SAM Twin Phantom**

The SAM twin phantom is a fiberglass shell phantom with 2mm shell thickness (except the ear region, where shell thickness increases to 6 mm). The phantom has three measurement areas:

- \_ Left Head
- \_ Right Head
- \_ Flat phantom

The phantom table for the DASY systems based on the robots have the size of 100 x 50 x 85 cm (L x W x H). For easy dislocation these tables have fork lift cut outs at the bottom.

The bottom plate contains three pairs of bolts for locking the device holder. The device holder positions are adjusted to the standard measurement positions in the three sections. Only one device holder is necessary if two phantoms are used (e.g., for different liquids)



A white cover is provided to cover the phantom during off-periods to prevent water evaporation and changes in the liquid parameters. Free space scans of devices on top of this phantom cover are possible. Three reference marks are provided on the phantom counter. These reference marks are used to teach the absolute phantom position relative to the robot.

### **Robots**

The DASY5 system uses the high precision industrial robot. The robot offers the same features important for our application:

- High precision (repeatability 0.02mm)
- High reliability (industrial design)
- Low maintenance costs (virtually maintenance free due to direct drive gears; no belt drives)
- Jerk-free straight movements (brushless synchrony motors; no stepper motors)
- Low ELF interference (motor control fields shielded via the closed metallic construction shields)

The above mentioned robots are controlled by the Staubli CS8c robot controllers. All information regarding the use and maintenance of the robot arm and the robot controller is contained on the CDs delivered along with the robot. Paper manuals are available upon request direct from Staubli.

## SAR Scan Procedures

### Step 1: Power Reference Measurement

The Power Reference Measurement and Power Drift Measurements are for monitoring the power drift of the device under test in the batch process. The minimum distance of probe sensors to surface determines the closest measurement point to phantom surface. The minimum distance of probe sensors to surface is 1.4 mm. This distance cannot be smaller than the distance of sensor calibration points to probe tip as defined in the probe properties.

### Step 2: Area Scans

Area scans are defined prior to the measurement process being executed with a user defined variable spacing between each measurement point (integral) allowing low uncertainty measurements to be conducted. Scans defined for FCC applications utilize a 15mm 2 step integral, with 1.5mm interpolation used to locate the peak SAR area used for zoom scan assessments.

Where the system identifies multiple SAR peaks (which are within 25% of peak value) the system will provide the user with the option of assessing each peak location individually for zoom scan averaging.

Area Scan Parameters extracted from KDB 865664 D01 SAR Measurement 100 MHz to 6 GHz

	≤ 3 GHz	> 3 GHz
Maximum distance from closest measurement point (geometric center of probe sensors) to phantom surface	5 mm ± 1 mm	$\frac{1}{2} \cdot \delta \cdot \ln(2)$ mm ± 0.5 mm
Maximum probe angle from probe axis to phantom surface normal at the measurement location	30° ± 1°	20° ± 1°
Maximum area scan spatial resolution: $\Delta x_{Area}$ , $\Delta y_{Area}$	≤ 2 GHz: ≤ 15 mm 2 – 3 GHz: ≤ 12 mm	3 – 4 GHz: ≤ 12 mm 4 – 6 GHz: ≤ 10 mm
	When the x or y dimension of the test device, in the measurement plane orientation, is smaller than the above, the measurement resolution must be ≤ the corresponding x or y dimension of the test device with at least one measurement point on the test device.	

### Step 3: Zoom Scan (Cube Scan Averaging)

The averaging zoom scan volume utilized in the DASY5 software is in the shape of a cube and the side dimension of a 1 g or 10 g mass is dependent on the density of the liquid representing the simulated tissue. A density of 1000 kg/m<sup>3</sup> is used to represent the head and body tissue density and not the phantom liquid density, in order to be consistent with the definition of the liquid dielectric properties, i.e. the side length of the 1g cube is 10mm, with the side length of the 10g cube is 21.5mm.

Zoom Scan Parameters extracted from KDB 865664 D01 SAR Measurement 100 MHz to 6 GHz

			≤ 3 GHz	> 3 GHz
Maximum zoom scan spatial resolution: $\Delta x_{Zoom}$ , $\Delta y_{Zoom}$			≤ 2 GHz: ≤ 8 mm 2 – 3 GHz: ≤ 5 mm*	3 – 4 GHz: ≤ 5 mm* 4 – 6 GHz: ≤ 4 mm*
Maximum zoom scan spatial resolution, normal to phantom surface	uniform grid: $\Delta z_{Zoom}(n)$		≤ 5 mm	3 – 4 GHz: ≤ 4 mm 4 – 5 GHz: ≤ 3 mm 5 – 6 GHz: ≤ 2 mm
	graded grid	$\Delta z_{Zoom}(1)$ : between 1 <sup>st</sup> two points closest to phantom surface	≤ 4 mm	3 – 4 GHz: ≤ 3 mm 4 – 5 GHz: ≤ 2.5 mm 5 – 6 GHz: ≤ 2 mm
		$\Delta z_{Zoom}(n>1)$ : between subsequent points	≤ 1.5 · $\Delta z_{Zoom}(n-1)$ mm	
Minimum zoom scan volume	x, y, z	≥ 30 mm	3 – 4 GHz: ≥ 28 mm 4 – 5 GHz: ≥ 25 mm 5 – 6 GHz: ≥ 22 mm	
Note: $\delta$ is the penetration depth of a plane-wave at normal incidence to the tissue medium; see IEEE Std 1528-2013 for details. * When zoom scan is required and the <i>reported</i> SAR from the <i>area scan based 1-g SAR estimation</i> procedures of KDB Publication 447498 is ≤ 1.4 W/kg, ≤ 8 mm, ≤ 7 mm and ≤ 5 mm zoom scan resolution may be applied, respectively, for 2 GHz to 3 GHz, 3 GHz to 4 GHz and 4 GHz to 6 GHz.				

### Step 4: Power Drift Measurement

The Power Drift Measurement measures the field at the same location as the most recent power reference measurement within the same procedure, and with the same settings. The Power Drift Measurement gives the field difference in dB from the reading conducted within the last Power Reference Measurement. This allows a user to monitor the power drift of the device under test within a batch process. The measurement procedure is the same as Step 1.

When the cube intersects with the surface of the phantom, it is oriented so that 3 vertices touch the surface of the shell or the center of a face is tangent to the surface. The face of the cube closest to the surface is modified in order to conform to the tangent surface.

The zoom scan integer steps can be user defined so as to reduce uncertainty, but normal practice for typical test applications (including FCC) utilize a physical step of 7 x7 x 7 (5mmx5mmx5mm) providing a volume of 30 mm in the X & Y & Z axis.



### Tissue Dielectric Parameters for Head and Body Phantoms

The head tissue dielectric parameters recommended by the IEC 62209-1:2016

#### Recommended Tissue Dielectric Parameters for Head liquid

**Table A.3 – Dielectric properties of the head tissue-equivalent liquid**

Frequency MHz	Relative permittivity $\epsilon_r$	Conductivity ( $\sigma$ ) S/m
300	45,3	0,87
450	43,5	0,87
<i>750</i>	<i>41,9</i>	<i>0,89</i>
835	41,5	0,90
900	41,5	0,97
1 450	40,5	1,20
<i>1 500</i>	<i>40,4</i>	<i>1,23</i>
<i>1 640</i>	<i>40,2</i>	<i>1,31</i>
<i>1 750</i>	<i>40,1</i>	<i>1,37</i>
1 800	40,0	1,40
1 900	40,0	1,40
2 000	40,0	1,40
<i>2 100</i>	<i>39,8</i>	<i>1,49</i>
<i>2 300</i>	<i>39,5</i>	<i>1,67</i>
2 450	39,2	1,80
<i>2 600</i>	<i>39,0</i>	<i>1,96</i>
3 000	38,5	2,40
<i>3 500</i>	<i>37,9</i>	<i>2,91</i>
<i>4 000</i>	<i>37,4</i>	<i>3,43</i>
<i>4 500</i>	<i>36,8</i>	<i>3,94</i>
<i>5 000</i>	<i>36,2</i>	<i>4,45</i>
<i>5 200</i>	<i>36,0</i>	<i>4,66</i>
<i>5 400</i>	<i>35,8</i>	<i>4,86</i>
<i>5 600</i>	<i>35,5</i>	<i>5,07</i>
<i>5 800</i>	<i>35,3</i>	<i>5,27</i>
<i>6 000</i>	<i>35,1</i>	<i>5,48</i>

NOTE For convenience, permittivity and conductivity values at those frequencies which are not part of the original data provided by Drossos et al. [33] or the extension to 5 800 MHz are provided (i.e. the values shown *in italics*). These values were linearly interpolated between the values in this table that are immediately above and below these values, except the values at 6 000 MHz that were linearly extrapolated from the values at 3 000 MHz and 5 800 MHz.

### 3. EQUIPMENT LIST AND CALIBRATION

#### 3.1 Equipments List & Calibration Information

Equipment	Model	S/N	Calibration Date	Calibration Due Date
DASY5 Test Software	DASY52.8	N/A	NCR	NCR
DASY5 Measurement Server	DASY5 5.0.28	1123	NCR	NCR
Data Acquisition Electronics	DAE4	1354	2022/10/31	2023/10/30
E-Field Probe	EX3DV4	7522	2023/5/29	2024/5/28
Mounting Device	MD4HHTV5	BJPCTC0152	NCR	NCR
Twin SAM	Twin SAM V5.0	1470	NCR	NCR
Dipole, 2450 MHz	D2450V2	1102	2023/3/27	2026/3/26
Dipole,5GHz	D5GHzV2	1246	2022/11/1	2025/10/31
Simulated Tissue Liquid Head(500-9500 MHz)	HBBL600-10000V6	220420-2	Each Time	/
Network Analyzer	8753B	2828A00170	2022/10/24	2023/10/23
Dielectric assessment kit	1319	SM DAK 040 CA	NCR	NCR
MXG Vector Signal Generator	N5182B	MY51350144	2023/3/31	2024/3/30
Power Meter	ML2495A	1106009	2023/8/4	2024/8/3
Pulse Power Sensor	MA2411A	10780	2023/8/4	2024/8/3
Power Amplifier	ZVE-6W-83+	637202210	NCR	NCR
Directional Coupler	441493	520Z	NCR	NCR
Attenuator	20dB, 100W	LN749	NCR	NCR
Attenuator	6dB, 150W	2754	NCR	NCR
Thermometer	DTM3000	3892	2023/3/31	2024/3/30
Spectrum Analyzer	FSV40	101943	2023/3/31	2024/3/30

## 4. SAR MEASUREMENT SYSTEM VERIFICATION

### 4.1 Liquid Verification

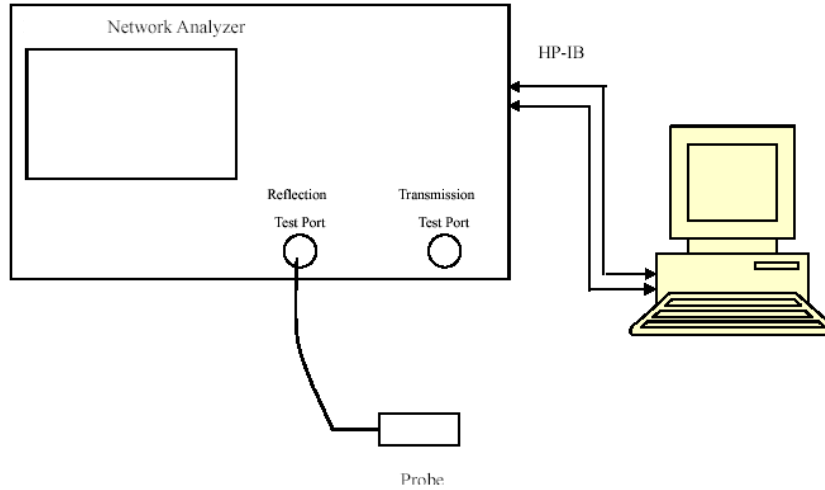

Liquid Verification Setup Block Diagram

### Liquid Verification Results

Frequency (MHz)	Liquid Type	Liquid Parameter		Target Value		Delta (%)		Tolerance (%)
		$\epsilon_r$	$\sigma$ (S/m)	$\epsilon_r$	$\sigma$ (S/m)	$\Delta\epsilon_r$	$\Delta\sigma$ (S/m)	
2400	Simulated Tissue Liquid Head	39.463	1.731	39.3	1.76	0.41	-1.65	$\pm 5$
2410	Simulated Tissue Liquid Head	39.426	1.743	39.28	1.77	0.37	-1.53	$\pm 5$
2420	Simulated Tissue Liquid Head	39.407	1.749	39.26	1.77	0.37	-1.19	$\pm 5$
2430	Simulated Tissue Liquid Head	39.392	1.754	39.24	1.78	0.39	-1.46	$\pm 5$
2440	Simulated Tissue Liquid Head	39.379	1.761	39.22	1.79	0.41	-1.62	$\pm 5$
2450	Simulated Tissue Liquid Head	39.347	1.768	39.2	1.8	0.37	-1.78	$\pm 5$
2460	Simulated Tissue Liquid Head	39.264	1.776	39.19	1.81	0.19	-1.88	$\pm 5$
2470	Simulated Tissue Liquid Head	39.215	1.783	39.17	1.82	0.11	-2.03	$\pm 5$
2480	Simulated Tissue Liquid Head	39.176	1.795	39.16	1.83	0.04	-1.91	$\pm 5$

\*Liquid Verification above was performed on 2023/09/27.

Frequency (MHz)	Liquid Type	Liquid Parameter		Target Value		Delta (%)		Tolerance (%)
		$\epsilon_r$	$\sigma$ (S/m)	$\epsilon_r$	$\sigma$ (S/m)	$\Delta\epsilon_r$	$\Delta\sigma$ (S/m)	
5180	Simulated Tissue Liquid Head	36.585	4.496	36.02	4.64	1.57	-3.1	$\pm 5$
5190	Simulated Tissue Liquid Head	36.62	4.508	36.01	4.65	1.69	-3.05	$\pm 5$
5200	Simulated Tissue Liquid Head	36.638	4.515	36	4.66	1.77	-3.11	$\pm 5$
5210	Simulated Tissue Liquid Head	36.638	4.524	35.99	4.67	1.8	-3.13	$\pm 5$
5220	Simulated Tissue Liquid Head	36.651	4.533	35.98	4.68	1.86	-3.14	$\pm 5$
5230	Simulated Tissue Liquid Head	36.65	4.543	35.97	4.69	1.89	-3.13	$\pm 5$
5240	Simulated Tissue Liquid Head	36.627	4.55	35.96	4.7	1.85	-3.19	$\pm 5$
5250	Simulated Tissue Liquid Head	36.597	4.558	35.95	4.71	1.8	-3.23	$\pm 5$
5740	Simulated Tissue Liquid Head	35.435	5.138	35.36	5.21	0.21	-1.38	$\pm 5$
5750	Simulated Tissue Liquid Head	35.393	5.148	35.35	5.22	0.12	-1.38	$\pm 5$
5760	Simulated Tissue Liquid Head	35.365	5.156	35.34	5.23	0.07	-1.41	$\pm 5$
5770	Simulated Tissue Liquid Head	35.346	5.163	35.33	5.24	0.05	-1.47	$\pm 5$
5780	Simulated Tissue Liquid Head	35.328	5.171	35.32	5.25	0.02	-1.5	$\pm 5$
5790	Simulated Tissue Liquid Head	35.301	5.188	35.31	5.26	-0.03	-1.37	$\pm 5$
5800	Simulated Tissue Liquid Head	35.29	5.206	35.3	5.27	-0.03	-1.21	$\pm 5$
5810	Simulated Tissue Liquid Head	35.286	5.234	35.29	5.28	-0.01	-0.87	$\pm 5$
5820	Simulated Tissue Liquid Head	35.29	5.271	35.28	5.29	0.03	-0.36	$\pm 5$
5830	Simulated Tissue Liquid Head	35.282	5.301	35.27	5.3	0.03	0.02	$\pm 5$

\*Liquid Verification above was performed on 2023/09/27.

### 4.2 System Accuracy Verification

Prior to the assessment, the system validation kit was used to test whether the system was operating within its specifications of  $\pm 10\%$ . The validation results are tabulated below. And also the corresponding SAR plot is attached as well in the SAR plots files.

The spacing distances in the **System Verification Setup Block Diagram** is given by the following:

- a)  $s = 15 \text{ mm} \pm 0,2 \text{ mm}$  for  $300 \text{ MHz} \leq f \leq 1\,000 \text{ MHz}$ ;
- b)  $s = 10 \text{ mm} \pm 0,2 \text{ mm}$  for  $1\,000 \text{ MHz} < f \leq 3\,000 \text{ MHz}$ ;
- c)  $s = 10 \text{ mm} \pm 0,2 \text{ mm}$  for  $3\,000 \text{ MHz} < f \leq 6\,000 \text{ MHz}$ .

#### System Verification Setup Block Diagram

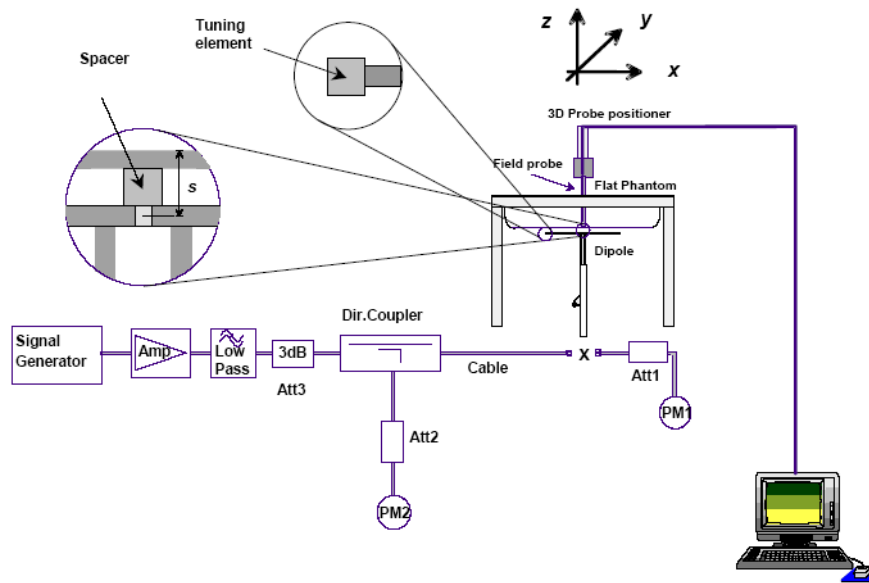

#### System Accuracy Check Results

Date	Frequency Band	Liquid Type	Input Power (mW)	Measured SAR (W/kg)	Normalized to 1W (W/kg)	Target Value (W/kg)	Delta (%)	Tolerance (%)
2023/09/27	2450 MHz	Simulated Tissue Liquid Head	100	1g   4.76	47.6	50.9	-6.48	$\pm 10$
2023/09/27	5250 MHz	Simulated Tissue Liquid Head	100	1g   7.86	78.6	77.5	1.42	$\pm 10$
2023/09/27	5750 MHz	Simulated Tissue Liquid Head	100	1g   7.73	77.3	78.4	-1.4	$\pm 10$

\*The SAR values above are normalized to 1 Watt forward power.

### 4.3 SAR SYSTEM VALIDATION DATA

#### System Performance 2450MHz

**DUT: D2450V2; Type: 2450 MHz; Serial: 1102**

Communication System: CW (0); Frequency: 2450 MHz; Duty Cycle: 1:1  
 Medium parameters used:  $f = 2450$  MHz;  $\sigma = 1.768$  S/m;  $\epsilon_r = 39.347$ ;  $\rho = 1000$  kg/m<sup>3</sup>  
 Phantom section: Flat Section

DASY5 Configuration:

- Probe: EX3DV4 - SN7522; ConvF(7.42, 7.42, 7.42) @ 2450 MHz; Calibrated: 2023/5/29
- Sensor-Surface: 1.4mm (Mechanical Surface Detection)
- Electronics: DAE4 Sn1354; Calibrated: 2022/10/31
- Phantom: Twin SAM; Type: Twin SAM V5.0; Serial: TP:1470
- Measurement SW: DASY52, Version 52.10 (2); SEMCAD X Version 14.6.12 (7470)

**Area Scan (6x11x1):** Measurement grid: dx=12mm, dy=12mm  
 Maximum value of SAR (measured) = 6.90 W/kg

**Zoom Scan (7x7x7)/Cube 0:** Measurement grid: dx=5mm, dy=5mm, dz=5mm  
 Reference Value = 33.95 V/m; Power Drift = -0.15 dB  
 Peak SAR (extrapolated) = 9.56 W/kg  
**SAR(1 g) = 4.76 W/kg; SAR(10 g) = 2.32 W/kg**  
 Maximum value of SAR (measured) = 7.14 W/kg

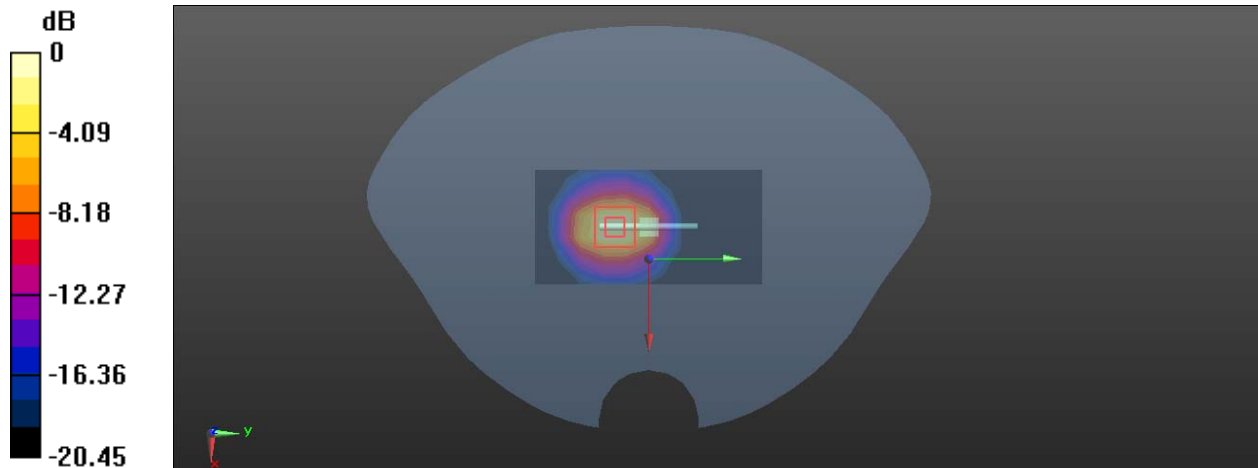

0 dB = 7.14 W/kg = 8.54 dBW/kg

**System Performance 5250 MHz****DUT: D5GHzV2; Type: 5250 MHz; Serial: 1246**

Communication System: CW (0); Frequency: 5250 MHz; Duty Cycle: 1:1  
Medium parameters used:  $f = 5250$  MHz;  $\sigma = 4.558$  S/m;  $\epsilon_r = 36.597$ ;  $\rho = 1000$  kg/m<sup>3</sup>  
Phantom section: Flat Section

DASY5 Configuration:

- Probe: EX3DV4 - SN7522; ConvF(5.36, 5.36, 5.36) @ 5250 MHz; Calibrated: 2023/5/29
- Sensor-Surface: 1.4mm (Mechanical Surface Detection)
- Electronics: DAE4 Sn1354; Calibrated: 2022/10/31
- Phantom: Twin SAM; Type: Twin SAM V5.0; Serial: TP:1470
- Measurement SW: DASY52, Version 52.10 (2); SEMCAD X Version 14.6.12 (7470)

**Area Scan (5x7x1):** Measurement grid: dx=10mm, dy=10mm  
Maximum value of SAR (measured) = 14.9 W/kg

**Zoom Scan (8x8x6)/Cube 0:** Measurement grid: dx=4mm, dy=4mm, dz=2mm  
Reference Value = 40.39 V/m; Power Drift = 0.11 dB  
Peak SAR (extrapolated) = 29.7 W/kg  
**SAR(1 g) = 7.86 W/kg; SAR(10 g) = 2.28 W/kg**  
Maximum value of SAR (measured) = 18.9 W/kg

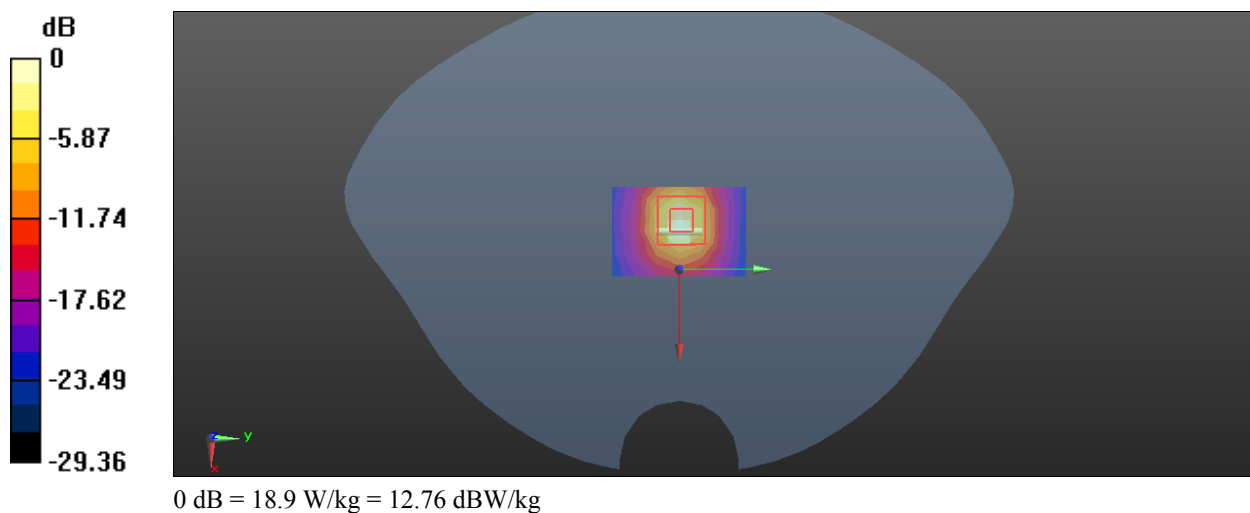

**System Performance 5750 MHz****DUT: D5GHzV2; Type: 5750 MHz; Serial: 1246**

Communication System: UID 0, CW (0); Frequency: 5750 MHz; Duty Cycle: 1:1  
Medium parameters used:  $f = 5750$  MHz;  $\sigma = 5.148$  S/m;  $\epsilon_r = 35.393$ ;  $\rho = 1000$  kg/m<sup>3</sup>  
Phantom section: Flat Section

DASY5 Configuration:

- Probe: EX3DV4 - SN7522; ConvF(4.9, 4.9, 4.9) @ 5750 MHz; Calibrated: 2023/5/29
- Sensor-Surface: 1.4mm (Mechanical Surface Detection)
- Electronics: DAE4 Sn1354; Calibrated: 2022/10/31
- Phantom: Twin SAM; Type: Twin SAM V5.0; Serial: TP:1470
- Measurement SW: DASY52, Version 52.10 (2); SEMCAD X Version 14.6.12 (7470)

**Area Scan (5x7x1):** Measurement grid: dx=10mm, dy=10mm  
Maximum value of SAR (measured) = 18.5 W/kg

**Zoom Scan (8x8x6)/Cube 0:** Measurement grid: dx=4mm, dy=4mm, dz=2mm  
Reference Value = 39.29 V/m; Power Drift = -0.05 dB  
Peak SAR (extrapolated) = 36.4 W/kg  
**SAR(1 g) = 7.73 W/kg; SAR(10 g) = 2.18 W/kg**  
Maximum value of SAR (measured) = 20.4 W/kg

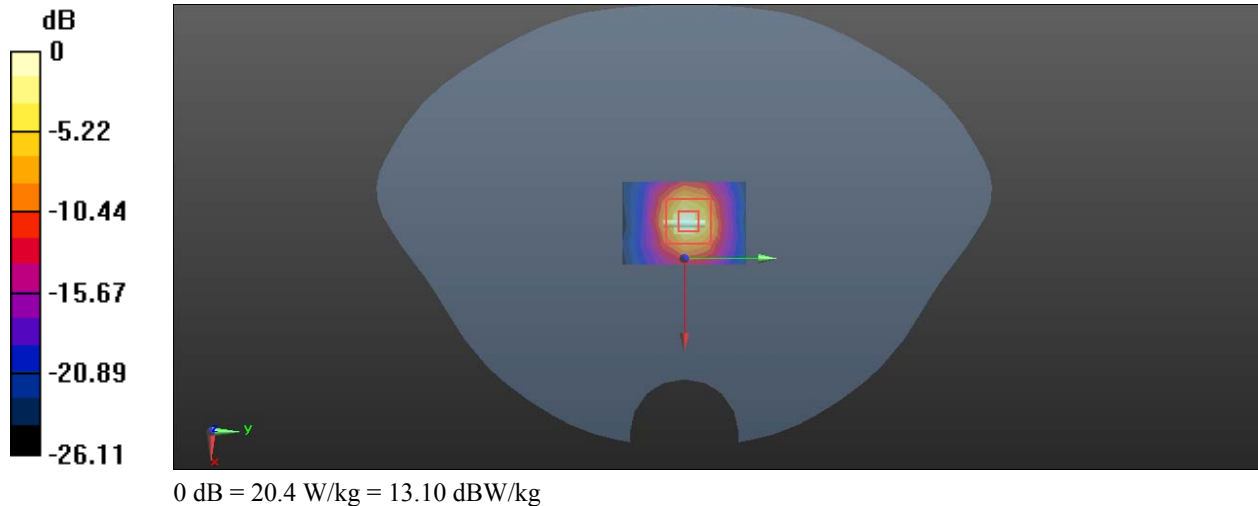



## 5. EUT TEST STRATEGY AND METHODOLOGY

### 5.1 Test positions for body-worn and other configurations

Body-worn operating configurations should be tested with the belt-clips and holsters attached to the device and positioned against a flat phantom in normal use configurations. Devices with a headset output should be tested with a headset connected to the device. When multiple accessories that do not contain metallic components are supplied with the device, the device may be tested with only the accessory that dictates the closest spacing to the body. When multiple accessories that contain metallic components are supplied with the device, the device must be tested with each accessory that contains a unique metallic component. If multiple accessories share an identical metallic component (e.g., the same metallic belt-clip used with different holsters with no other metallic components), only the accessory that dictates the closest spacing to the body must be tested.

Body-worn accessories may not always be supplied or available as options for some devices that are intended to be authorized for body-worn use. A separation distance of 1.5 cm between the back of the device and a flat phantom is recommended for testing body-worn SAR compliance under such circumstances. Other separation distances may be used, but they should not exceed 2.5 cm. In these cases, the device may use body-worn accessories that provide a separation distance greater than that tested for the device provided however that the accessory contains no metallic components.

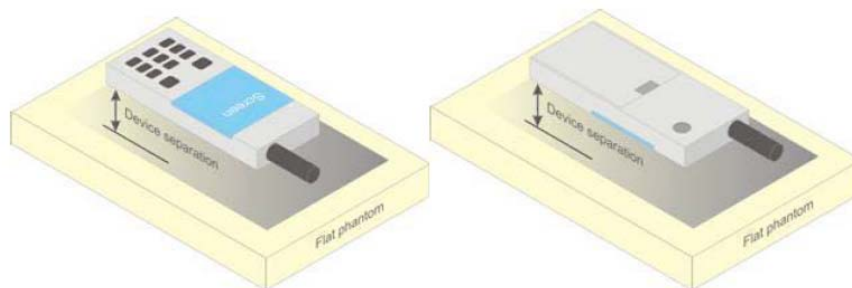

Figure 5 – Test positions for body-worn devices

### 5.2 Test Distance for SAR Evaluation

In this case the EUT(Equipment Under Test) is set 0mm away from the phantom, the test distance is 0mm.

### 5.3 SAR Evaluation Procedure

The evaluation was performed with the following procedure:

Step 1: Measurement of the SAR value at a fixed location above the ear point or central position was used as a reference value for assessing the power drop. The SAR at this point is measured at the start of the test and then again at the end of the testing.

Step 2: The SAR distribution at the exposed side of the head was measured at a distance of 4 mm from the inner surface of the shell. The area covered the entire dimension of the head or radiating structures of the EUT, the horizontal grid spacing was 15 mm x 15 mm, and the SAR distribution was determined by integrated grid of 1.5mm x 1.5mm. Based on these data, the area of the maximum absorption was determined by spline interpolation. The first Area Scan covers the entire dimension of the EUT to ensure that the hotspot was correctly identified.

Step 3: Around this point, a volume of 30 mm x 30 mm x 30 mm was assessed by measuring 7x 7 x 7 points. On the basis of this data set, the spatial peak SAR value was evaluated under the following procedure:

1) The data at the surface were extrapolated, since the center of the dipoles is 1.2 mm away from the tip of the probe and the distance between the surface and the lowest measuring point is 1.3 mm. The extrapolation was based on a least square algorithm. A polynomial of the fourth order was calculated through the points in z-axes. This polynomial was then used to evaluate the points between the surface and the probe tip.

2) The maximum interpolated value was searched with a straightforward algorithm. Around this maximum the SAR values averaged over the spatial volumes (1 g or 10 g) were computed by the 3D-Spline interpolation algorithm. The 3D-Spline is composed of three one dimensional splines with the "Not a knot"-condition (in x, y and z-directions). The volume was integrated with the trapezoidal-algorithm. One thousand points (10 x 10 x 10) were interpolated to calculate the averages.

All neighboring volumes were evaluated until no neighboring volume with a higher average value was found.

Step 4: Re-measurement of the SAR value at the same location as in Step 1. If the value changed by more than 5%, the evaluation was repeated.

## 6. CONDUCTED OUTPUT POWER MEASUREMENT

### 6.1 Test Procedure

The RF output of the transmitter was connected to the input port of the Pulse Power Sensor through Connector.

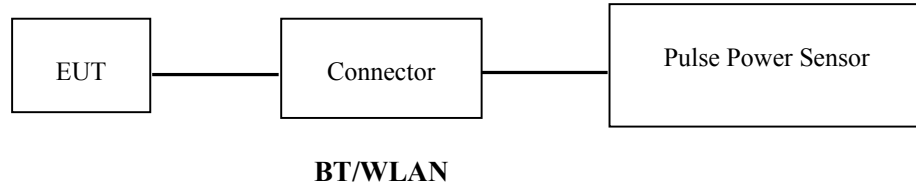

### 6.2 Maximum Target Output Power

Max Target Average Power(dBm)			
Mode/Band	Channel		
	Low	Middle	High
WLAN 2.4G(802.11b)	13.9	13.9	13.9
WLAN 2.4G(802.11g)	12	12	12
WLAN 2.4G(802.11n ht20)	11.8	11.8	11.8
WLAN 2.4G(802.11n ht40)	11.6	11.6	11.6
WLAN 5.2G(802.11a)	13.4	13.4	13.4
WLAN 5.2G(802.11n20)	12.6	12.6	12.6
WLAN 5.2G(802.11n40)	12.8	/	12.8
WLAN 5.2G(802.11ac80)	/	8	/
WLAN 5.8G(802.11a)	13.6	13.6	13.6
WLAN 5.8G(802.11n20)	12.6	12.6	12.6
WLAN 5.8G(802.11n40)	12.4	/	12.4
WLAN 5.8G(802.11ac80)	/	7.7	/
Bluetooth BDR/EDR	5	5	5
BLE	-2	-2	-2

**6.3 Test Results:****WLAN 2.4G:**

Mode	Channel frequency (MHz)	Data Rate	Duty cycle (%)	RF Average Output Power (dBm)
802.11b	2412	1Mbps	100	13.65
	2437			<b>13.75</b>
	2462			13.69
802.11g	2412	6Mbps	95.82	11.94
	2437			11.87
	2462			11.81
802.11n ht20	2412	MCS0	96.57	11.69
	2437			11.62
	2462			11.64
802.11n ht40	2422	MCS0	91.38	11.45
	2437			11.39
	2452			11.49

**Wi-Fi 5.2G:**

Mode	Channel frequency (MHz)	Data Rate	Duty cycle (%)	RF Average Output Power (dBm)
802.11a	5180	6Mbps	96.99	12.71
	5200			12.49
	5240			13.32
802.11n20	5180	MCS0	96.15	11.79
	5200			11.63
	5240			12.48
802.11n40	5190	MCS0	91.74	11.64
	5230			12.67
802.11ac80	5210	MCS0	84.23	7.92

**Wi-Fi 5.8G:**

Mode	Channel frequency (MHz)	Data Rate	Duty cycle (%)	RF Average Output Power (dBm)
802.11a	5745	6Mbps	96.99	13.56
	5785			13.35
	5825			12.68
802.11n20	5745	MCS0	96.15	12.51
	5785			12.09
	5825			11.73
802.11n40	5755	MCS0	91.74	12.26
	5795			11.95
802.11ac80	5775	MCS0	84.23	7.54

**Bluetooth:**

Mode	Channel frequency (MHz)	RF Output Power (dBm)
BDR(GFSK)	2402	2.79
	2441	3.37
	2480	3.41
EDR( $\pi/4$ -DQPSK)	2402	3.87
	2441	4.31
	2480	<b>4.49</b>
EDR(8DPSK)	2402	3.52
	2441	3.91
	2480	3.97
BLE_1M	2402	-2.71
	2440	-2.69
	2480	-2.86

## 7. Standalone SAR test exclusion considerations

Antennas Location:

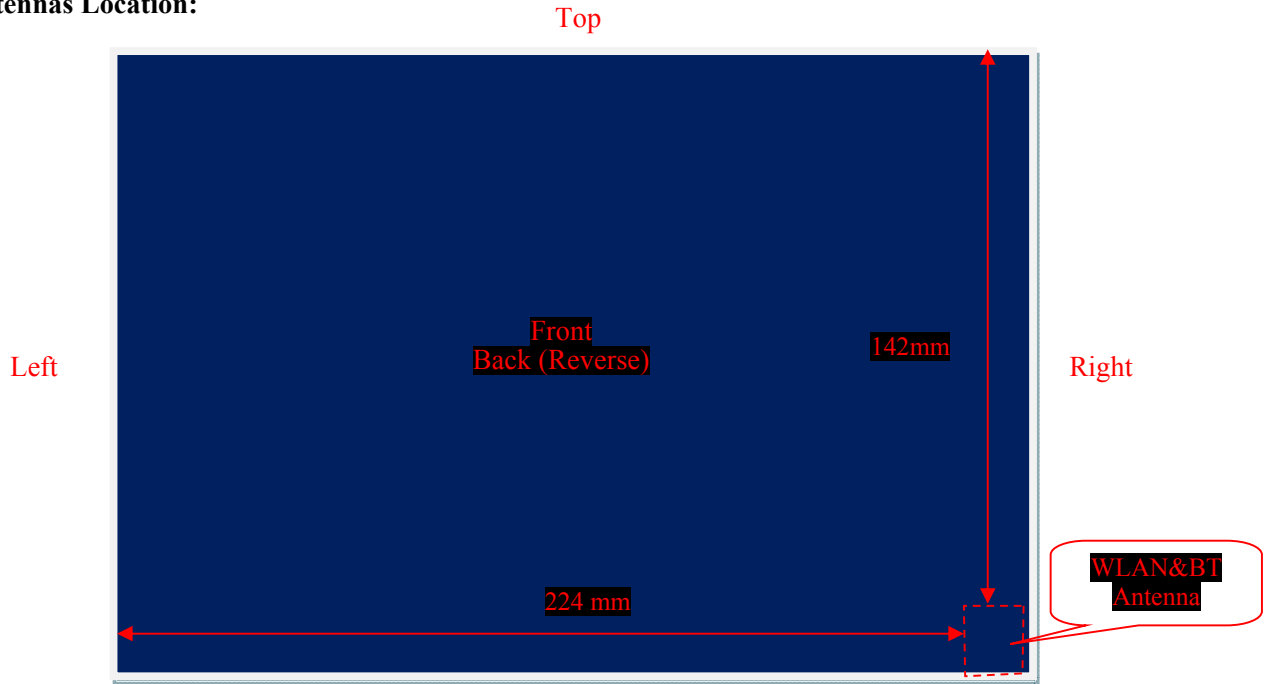

### 7.1 Antenna Distance To Edge

Antenna Distance To Edge(mm)						
Antenna	Front	Back	Left	Right	Top	Bottom
WLAN & BT Antenna	< 5	< 5	224	< 5	142	< 5

### 7.2 Standalone SAR test exclusion considerations

Mode	Frequency (MHz)	Output Power (dBm)	Output Power (mW)	Distance (mm)	Calculated value	Threshold (1-g)	SAR Test Exclusion
Wi-Fi 2.4G	2462	13.9	24.55	0	7.7	3	NO
WLAN 5.2G	5240	13.4	21.88	0	10.0	3	NO
WLAN 5.8G	5825	13.6	22.91	0	11.1	3	NO
Bluetooth	2480	5	3.16	0	1.0	3	YES

Note: The bluetooth based peak power for calculation, and Wi-Fi based average power for calculation.

**NOTE:**

The 1-g and 10-g SAR test exclusion thresholds for 100 MHz to 6 GHz at test separation distances ≤ 50 mm are determined by:

$$[(\text{max. power of channel, including tune-up tolerance, mW}) / (\text{min. test separation distance, mm})] \cdot \sqrt{f(\text{GHz})} \leq 3.0 \text{ for 1-g SAR and } \leq 7.5 \text{ for 10-g extremity SAR, where}$$

1. f(GHz) is the RF channel transmit frequency in GHz.
2. Power and distance are rounded to the nearest mW and mm before calculation.
3. The result is rounded to one decimal place for comparison.
4. When the minimum test separation distance is < 5 mm, a distance of 5 mm is applied to determine SAR test Exclusion.

**7.3 Standalone SAR estimation:**

Mode	Frequency (MHz)	Output Power (dBm)	Output Power (mW)	Distance (mm)	Estimated 1-g (W/kg)
BT Body	2480	5	3.16	0	0.13

**Note:** The bluetooth based peak power for calculation.

When standalone SAR test exclusion applies to an antenna that transmits simultaneously with other antennas, the standalone SAR must be estimated according to following to determine simultaneous transmission SAR test exclusion:

$$\left[ \frac{(\text{max. power of channel, including tune-up tolerance, mW})}{(\text{min. test separation distance, mm})} \right] \cdot \left[ \frac{f(\text{GHz})}{x} \right]$$

W/kg for test separation distances  $\leq 50$  mm;

where  $x = 7.5$  for 1-g SAR.

When the minimum test separation distance is  $< 5$  mm, a distance of 5 mm is applied to determine SAR test Exclusion

**7.4 Standalone SAR test exclusion considerations:**

Mode	Frequency (MHz)	Pavg (dBm)	Pavg (mW)	Test exclusion Threshold (mm)
Wi-Fi 2.4G	2462	13.9	24.55	13
Wi-Fi 5.2G	5240	13.4	21.88	17
Wi-Fi 5.8G	5825	13.6	22.91	19

**Note:** The maximum time based average power is used for calculation.

**7.5 SAR test exclusion for the EUT edge considerations Result**

According to KDB 616217 Section 4.3, SAR evaluation for the front surface of tablet display screens are generally not necessary.

Mode	Back Edge	Left Edge	Right Edge	Top Edge	Bottom Edge
WLAN 2.4G	<b>Required</b>	Exclusion	<b>Required</b>	Exclusion	<b>Required</b>
WLAN 5.2G	<b>Required</b>	Exclusion	<b>Required</b>	Exclusion	<b>Required</b>
WLAN 5.8G	<b>Required</b>	Exclusion	<b>Required</b>	Exclusion	<b>Required</b>
Bluetooth	Exclusion*	Exclusion*	Exclusion*	Exclusion*	Exclusion*

**Note:**

Required: The distance is less than **Test Exclusion Distance**, the SAR test is required.

Exclusion\*: SAR test exclusion evaluation has been done above.

Exclusion: The distance is large than **Test Exclusion Distance**, SAR test is not required.

**SAR test exclusion for the EUT edge considerations detail:****Distance < 50mm (To Edges)**

The 1-g and 10-g SAR test exclusion thresholds for 100 MHz to 6 GHz at test separation distances  $\leq 50$  mm are determined by:

$$\left[ \frac{\text{max. power of channel, including tune-up tolerance, mW}}{\text{min. test separation distance, mm}} \right] \cdot [\sqrt{f(\text{GHz})}] \leq 3.0$$

for 1-g SAR and  $\leq 7.5$  for 10-g extremity SAR, where

1.  $f(\text{GHz})$  is the RF channel transmit frequency in GHz.

2. Power and distance are rounded to the nearest mW and mm before calculation.

3. The result is rounded to one decimal place for comparison.

4. When the minimum test separation distance is  $< 5$  mm, a distance of 5 mm is applied to determine SAR test Exclusion.

**Distance > 50mm (To Edges)**

At 100 MHz to 6 GHz and for test separation distances  $> 50$  mm, the SAR test exclusion threshold is determined according to the following:

a.  $[\text{Power allowed at numeric threshold for 50 mm in step 1}) + (\text{test separation distance} - 50 \text{ mm}) \cdot (f(\text{MHz})/150)]$  mW, at 100 MHz to 1500 MHz

b.  $[\text{Power allowed at numeric threshold for 50 mm in step 1}) + (\text{test separation distance} - 50 \text{ mm}) \cdot 10]$  mW at  $> 1500$  MHz and  $\leq 6$  GHz.



## 8. SAR MEASUREMENT RESULTS

---

This page summarizes the results of the performed dosimetric evaluation.

### 8.1 SAR Test Data

#### Environmental Conditions

<b>Temperature:</b>	22.4-23.6°C
<b>Relative Humidity:</b>	56%
<b>ATM Pressure:</b>	100.5 kPa
<b>Test Date:</b>	2023/9/27

*Testing was performed by Leo Lu, Aixlee Li.*

**WLAN 2.4G:**

EUT Position	Frequency (MHz)	Test Mode	Max. Meas. Power (dBm)	Max. Rated Power (dBm)	1g SAR (W/kg)				
					Scaled Factor	Duty cycle Scaled Factor	Meas. SAR	Scaled SAR	Plot
Body Back (0mm)	2412	802.11b	/	/	/		/	/	/
	2437	802.11b	13.75	13.9	1.035	1	0.578	0.6	1#
	2462	802.11b	/	/	/		/	/	/
Body Right (0mm)	2412	802.11b	/	/	/		/	/	/
	2437	802.11b	13.75	13.9	1.035	1	0.133	0.14	2#
	2462	802.11b	/	/	/		/	/	/
Body Bottom (0mm)	2412	802.11b	/	/	/		/	/	/
	2437	802.11b	13.75	13.9	1.035	1	0.27	0.28	3#
	2462	802.11b	/	/	/		/	/	/

**Note:**

1. When the 1-g SAR is  $\leq 0.8$  W/kg, testing for other channels are optional.
2. When SAR or MPE is not measured at the maximum power level allowed for production units, the results must be scaled to the maximum tune-up tolerance limit according to the power applied to the individual channels tested to determine compliance.
3. KDB 248227 D01-SAR measurement is not required for 2.4 GHz OFDM(802.11g/n) when the highest reported SAR for DSSS(802.11b) is  $\leq 1.2$  W/kg, and the output power for DSSS is not less than that for OFDM.
4. According 2016 Oct. TCB, for SAR testing of 2.4G WIFI 802.11b signal with non-100% duty cycle, the measured SAR is scaled-up by the duty cycle scaling factor which is equal to "1/(duty cycle)".

**WLAN 5.2G:**

EUT Position	Frequency (MHz)	Test Mode	Max. Meas. Power (dBm)	Max. Rated Power (dBm)	1g SAR (W/kg)				
					Scaled Factor	Duty cycle Scaled Factor	Meas. SAR	Scaled SAR	Plot
Body Back (0mm)	5180	802.11a	/	/	/	/	/	/	/
	5200	802.11a	12.49	13.4	1.233	1.031	0.373	0.47	4#
	5240	802.11a	/	/	/	/	/	/	/
Body Right (0mm)	5180	802.11a	/	/	/	/	/	/	/
	5200	802.11a	12.49	13.4	1.233	1.031	0.085	0.11	5#
	5240	802.11a	/	/	/	/	/	/	/
Body Bottom (0mm)	5180	802.11a	/	/	/	/	/	/	/
	5200	802.11a	12.49	13.4	1.233	1.031	0.429	0.55	6#
	5240	802.11a	/	/	/	/	/	/	/

**WLAN 5.8G:**

EUT Position	Frequency (MHz)	Test Mode	Max. Meas. Power (dBm)	Max. Rated Power (dBm)	1g SAR (W/kg)				
					Scaled Factor	Duty cycle Scaled Factor	Meas. SAR	Scaled SAR	Plot
Body Back (0mm)	5745	802.11a	/	/	/	/	/	/	/
	5785	802.11a	13.35	13.6	1.059	1.031	0.647	0.71	7#
	5825	802.11a	/	/	/	/	/	/	/
Body Right (0mm)	5745	802.11a	/	/	/	/	/	/	/
	5785	802.11a	13.35	13.6	1.059	1.031	0.119	0.13	8#
	5825	802.11a	/	/	/	/	/	/	/
Body Bottom (0mm)	5745	802.11a	13.56	13.6	1.009	1.031	1.02	1.06	9#
	5785	802.11a	13.35	13.6	1.059	1.031	1.32	1.44	10#
	5825	802.11a	12.68	13.6	1.236	1.031	0.733	0.93	11#

**Note:**

1. When the 1-g SAR is  $\leq 0.8$ W/kg, testing for other channels are optional.
2. When SAR or MPE is not measured at the maximum power level allowed for production units, the results must be scaled to the maximum tune-up tolerance limit according to the power applied to the individual channels tested to determine compliance.
3. KDB 248227 D01-SAR measurement is not required for 2.4 GHz OFDM(802.11g/n) when the highest reported SAR for DSSS(802.11b) is  $\leq 1.2$  W/kg, and the output power for DSSS is not less than that for OFDM.
4. According 2016 Oct. TCB, for SAR testing of 5G WIFI 802.11a signal with non-100% duty cycle, the measured SAR is scaled-up by the duty cycle scaling factor which is equal to "1/(duty cycle)".

## 9. Measurement Variability

In accordance with published RF Exposure KDB procedure 865664 D01 SAR measurement 100 MHz to 6 GHz v01. These additional measurements are repeated after the completion of all measurements requiring the same head or body tissue-equivalent medium in a frequency band. The test device should be returned to ambient conditions (normal room temperature) with the battery fully charged before it is re-mounted on the device holder for the repeated measurement(s) to minimize any unexpected variations in the repeated results

- 1) Repeated measurement is not required when the original highest measured SAR is  $< 0.80$  W/kg; steps 2) through 4) do not apply.
- 2) When the original highest measured SAR is  $\geq 0.80$  W/kg, repeat that measurement once.
- 3) Perform a second repeated measurement only if the ratio of largest to smallest SAR for the original and first repeated measurements is  $> 1.20$  or when the original or repeated measurement is  $\geq 1.45$  W/kg (~ 10% from the 1-g SAR limit).
- 4) Perform a third repeated measurement only if the original, first or second repeated measurement is  $\geq 1.5$  W/kg and the ratio of largest to smallest SAR for the original, first and second repeated measurements is  $> 1.20$ .

*Note: The same procedures should be adapted for measurements according to extremity and occupational exposure limits by applying a factor of 2.5 for extremity exposure and a factor of 5 for occupational exposure to the corresponding SAR thresholds.*

### The Highest Measured SAR Configuration in Each Frequency Band

#### Body

SAR probe calibration point	Frequency Band	Freq.(MHz)	EUT Position	Meas. SAR (W/kg)		Largest to Smallest SAR Ratio
				Original	Repeated	
5750 MHz (5640-5860MHz)	WLAN 5.8G	5785	Body Bottom	1.32	1.27	1.04

#### Note:

1. Second Repeated Measurement is not required since the ratio of the largest to smallest SAR for the original and first repeated measurement is not  $> 1.20$ .
2. The measured SAR results **do not** have to be scaled to the maximum tune-up tolerance to determine if repeated measurements are required.
3. SAR measurement variability must be assessed for each frequency band, which is determined by the **SAR probe calibration point and tissue-equivalent medium** used for the device measurements.

## 10. SAR Plots

**Plot 1#: 2.4G WIFI Mid \_ Body Back**

**DUT: Tablet PC; Type: W120; Serial: 2B1J-1**

Communication System: 802.11 b (0); Frequency: 2437 MHz; Duty Cycle: 1:1  
 Medium parameters used (interpolated):  $f = 2437$  MHz;  $\sigma = 1.759$  S/m;  $\epsilon_r = 39.385$ ;  $\rho = 1000$  kg/m<sup>3</sup>  
 Phantom section: Flat Section

DASY5 Configuration:

- Probe: EX3DV4 - SN7522; ConvF(7.42, 7.42, 7.42) @ 2437 MHz; Calibrated: 2023/5/29
- Sensor-Surface: 1.4mm (Mechanical Surface Detection)
- Electronics: DAE4 Sn1354; Calibrated: 2022/10/31
- Phantom: Twin SAM; Type: Twin SAM V5.0; Serial: TP:1470
- Measurement SW: DASY52, Version 52.10 (2); SEMCAD X Version 14.6.12 (7470)

**Area Scan (9x15x1):** Measurement grid: dx=12mm, dy=12mm  
 Maximum value of SAR (measured) = 0.553 W/kg

**Zoom Scan (6x6x7)/Cube 0:** Measurement grid: dx=8mm, dy=8mm, dz=5mm  
 Reference Value = 8.801 V/m; Power Drift = 0.18 dB  
 Peak SAR (extrapolated) = 1.39 W/kg  
**SAR(1 g) = 0.578 W/kg; SAR(10 g) = 0.255 W/kg**  
 Maximum value of SAR (measured) = 0.621 W/kg

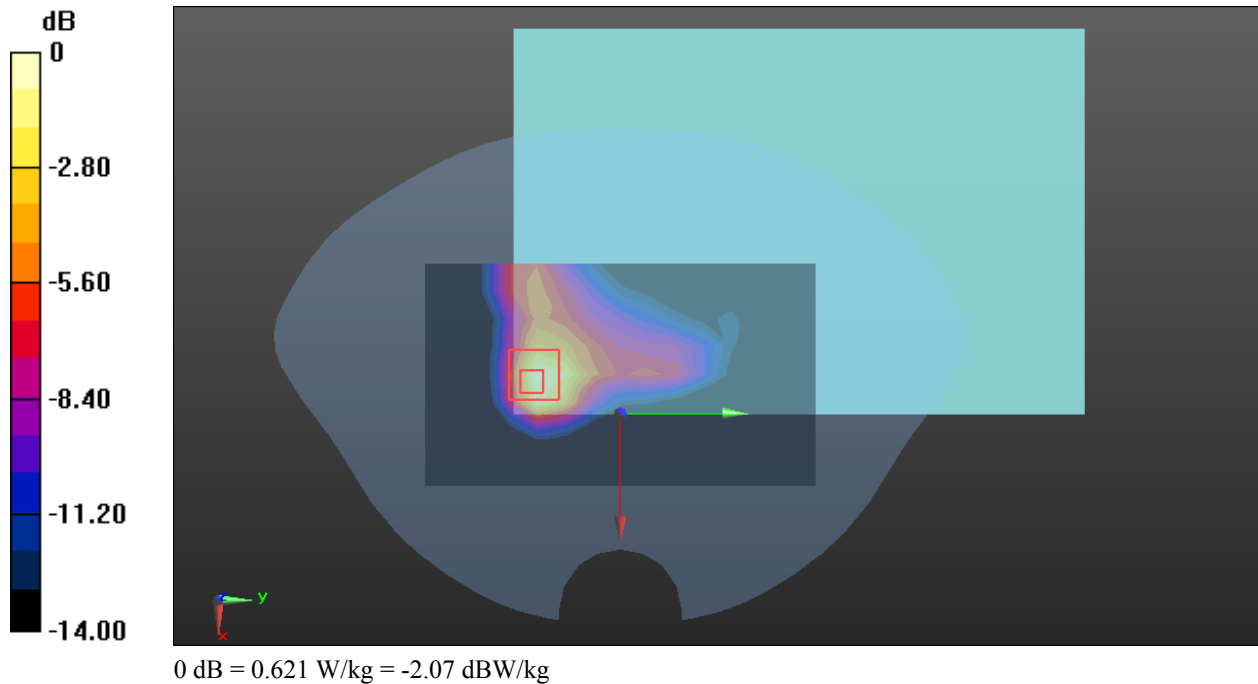

**Plot 2#: 2.4G WIFI Mid \_ Body Right****DUT: Tablet PC; Type: W120; Serial: 2B1J-1**

Communication System: 802.11 b (0); Frequency: 2437 MHz; Duty Cycle: 1:1  
Medium parameters used (interpolated):  $f = 2437$  MHz;  $\sigma = 1.759$  S/m;  $\epsilon_r = 39.385$ ;  $\rho = 1000$  kg/m<sup>3</sup>  
Phantom section: Flat Section

DASY5 Configuration:

- Probe: EX3DV4 - SN7522; ConvF(7.42, 7.42, 7.42) @ 2437 MHz; Calibrated: 2023/5/29
- Sensor-Surface: 1.4mm (Mechanical Surface Detection)
- Electronics: DAE4 Sn1354; Calibrated: 2022/10/31
- Phantom: Twin SAM; Type: Twin SAM V5.0; Serial: TP:1470
- Measurement SW: DASY52, Version 52.10 (2); SEMCAD X Version 14.6.12 (7470)

**Area Scan (6x13x1):** Measurement grid: dx=12mm, dy=12mm  
Maximum value of SAR (measured) = 0.141 W/kg

**Zoom Scan (5x5x7)/Cube 0:** Measurement grid: dx=8mm, dy=8mm, dz=5mm  
Reference Value = 7.092 V/m; Power Drift = 0.01 dB  
Peak SAR (extrapolated) = 0.250 W/kg  
**SAR(1 g) = 0.133 W/kg; SAR(10 g) = 0.074 W/kg**  
Maximum value of SAR (measured) = 0.146 W/kg

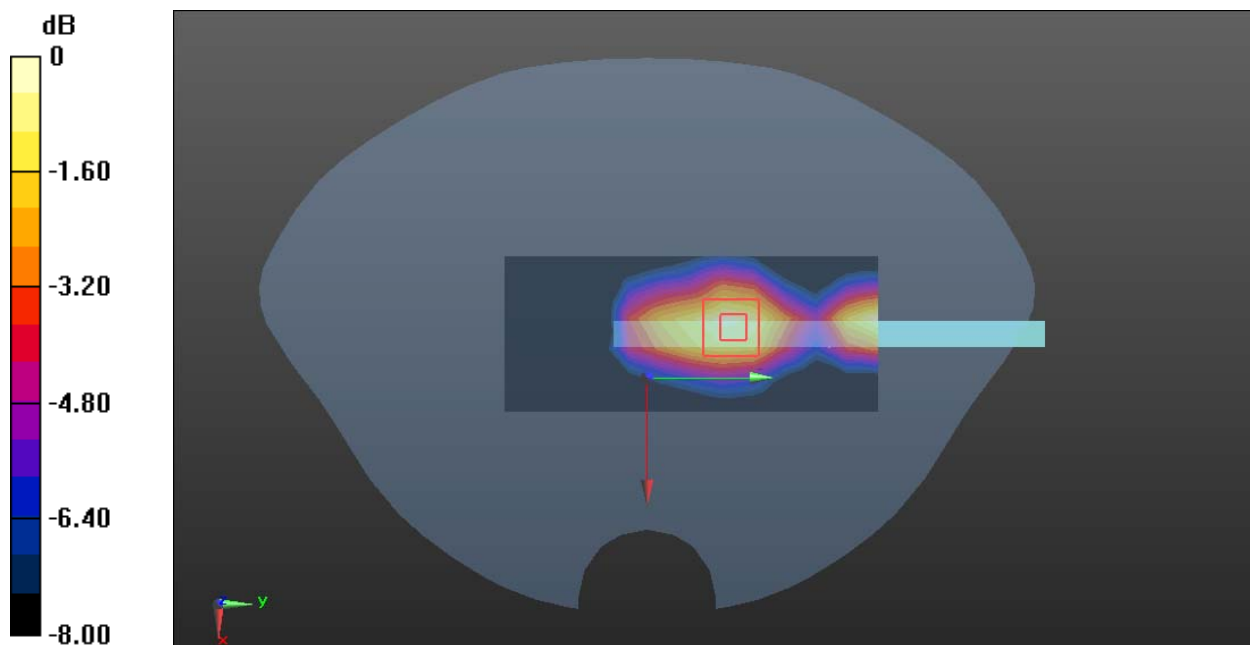

**Plot 3#: 2.4G WIFI Mid \_ Body Bottom****DUT: Tablet PC; Type: W120; Serial: 2B1J-1**

Communication System: 802.11 b (0); Frequency: 2437 MHz; Duty Cycle: 1:1  
Medium parameters used (interpolated):  $f = 2437$  MHz;  $\sigma = 1.759$  S/m;  $\epsilon_r = 39.385$ ;  $\rho = 1000$  kg/m<sup>3</sup>  
Phantom section: Flat Section

DASY5 Configuration:

- Probe: EX3DV4 - SN7522; ConvF(7.42, 7.42, 7.42) @ 2437 MHz; Calibrated: 2023/5/29
- Sensor-Surface: 1.4mm (Mechanical Surface Detection)
- Electronics: DAE4 Sn1354; Calibrated: 2022/10/31
- Phantom: Twin SAM; Type: Twin SAM V5.0; Serial: TP:1470
- Measurement SW: DASY52, Version 52.10 (2); SEMCAD X Version 14.6.12 (7470)

**Area Scan (6x13x1):** Measurement grid: dx=12mm, dy=12mm  
Maximum value of SAR (measured) = 0.262 W/kg

**Zoom Scan (5x5x7)/Cube 0:** Measurement grid: dx=8mm, dy=8mm, dz=5mm  
Reference Value = 12.30 V/m; Power Drift = 0.08 dB  
Peak SAR (extrapolated) = 0.695 W/kg  
**SAR(1 g) = 0.270 W/kg; SAR(10 g) = 0.112 W/kg**  
Maximum value of SAR (measured) = 0.307 W/kg

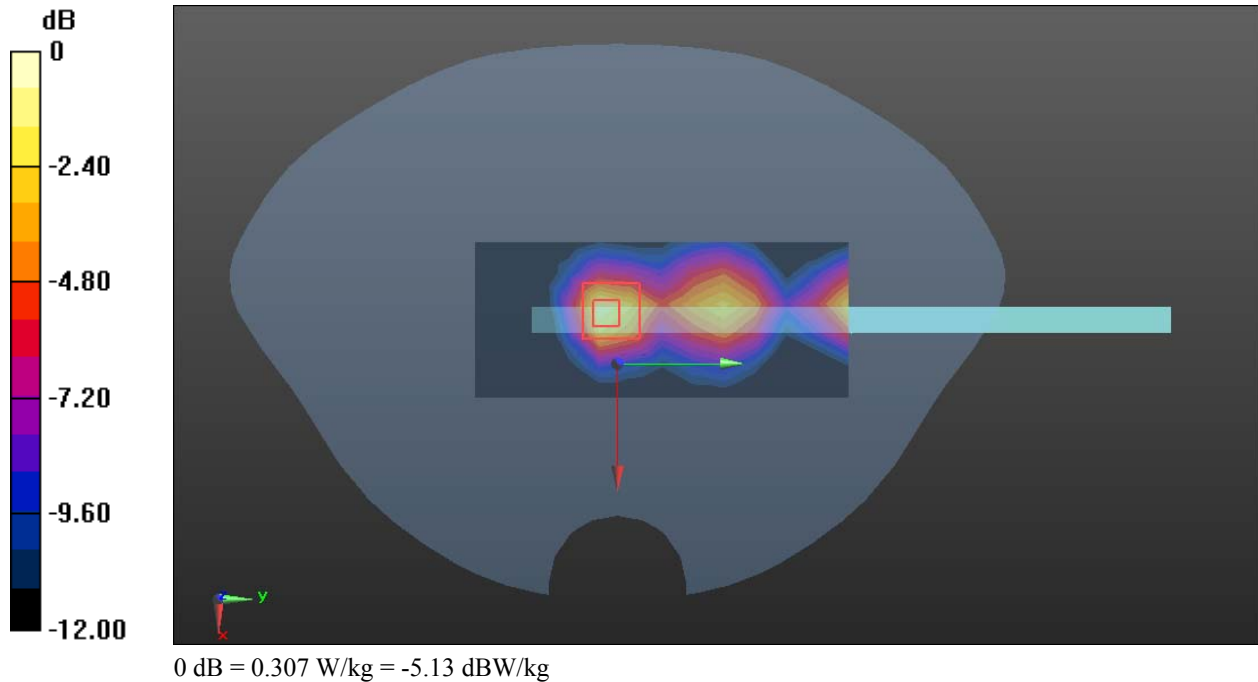

**Plot 4#: 5.2G WIFI Mid\_ Body Back****DUT: Tablet PC; Type: W120; Serial: 2BIJ-1**

Communication System: 802.11 a (0); Frequency: 5200 MHz; Duty Cycle: 1:1.031  
Medium parameters used:  $f = 5200$  MHz;  $\sigma = 4.515$  S/m;  $\epsilon_r = 36.638$ ;  $\rho = 1000$  kg/m<sup>3</sup>  
Phantom section: Flat Section

DASY5 Configuration:

- Probe: EX3DV4 - SN7522; ConvF(5.36, 5.36, 5.36) @ 5200 MHz; Calibrated: 2023/5/29
- Sensor-Surface: 1.4mm (Mechanical Surface Detection)
- Electronics: DAE4 Sn1354; Calibrated: 2022/10/31
- Phantom: Twin SAM; Type: Twin SAM V5.0; Serial: TP:1470
- Measurement SW: DASY52, Version 52.10 (2); SEMCAD X Version 14.6.12 (7470)

**Area Scan (10x10x1):** Measurement grid: dx=10mm, dy=10mm  
Maximum value of SAR (measured) = 0.698 W/kg

**Zoom Scan (8x8x6)/Cube 0:** Measurement grid: dx=4mm, dy=4mm, dz=2mm  
Reference Value = 6.330 V/m; Power Drift = 0.13 dB  
Peak SAR (extrapolated) = 1.49 W/kg  
**SAR(1 g) = 0.373 W/kg; SAR(10 g) = 0.192 W/kg**  
Maximum value of SAR (measured) = 0.951 W/kg

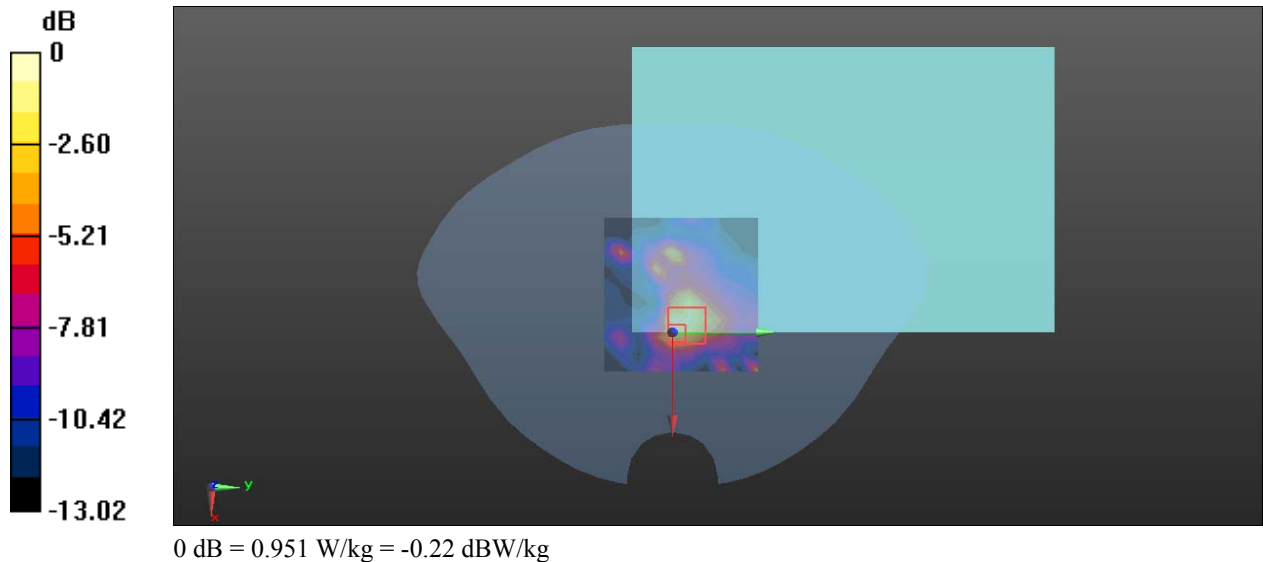



**Plot 5#: 5.2G WIFI Mid\_Body Right****DUT: Tablet PC; Type: W120; Serial: 2BIJ-1**

Communication System: 802.11 a (0); Frequency: 5200 MHz; Duty Cycle: 1:1.031  
Medium parameters used:  $f = 5200$  MHz;  $\sigma = 4.515$  S/m;  $\epsilon_r = 36.638$ ;  $\rho = 1000$  kg/m<sup>3</sup>  
Phantom section: Flat Section

DASY5 Configuration:

- Probe: EX3DV4 - SN7522; ConvF(5.36, 5.36, 5.36) @ 5200 MHz; Calibrated: 2023/5/29
- Sensor-Surface: 1.4mm (Mechanical Surface Detection)
- Electronics: DAE4 Sn1354; Calibrated: 2022/10/31
- Phantom: Twin SAM; Type: Twin SAM V5.0; Serial: TP:1470
- Measurement SW: DASY52, Version 52.10 (2); SEMCAD X Version 14.6.12 (7470)

**Area Scan (7x10x1):** Measurement grid: dx=10mm, dy=10mm  
Maximum value of SAR (measured) = 0.133 W/kg

**Zoom Scan (8x8x6)/Cube 0:** Measurement grid: dx=4mm, dy=4mm, dz=2mm  
Reference Value = 2.547 V/m; Power Drift = 0.13 dB  
Peak SAR (extrapolated) = 0.144 W/kg  
**SAR(1 g) = 0.085 W/kg; SAR(10 g) = 0.061 W/kg**  
Maximum value of SAR (measured) = 0.119 W/kg

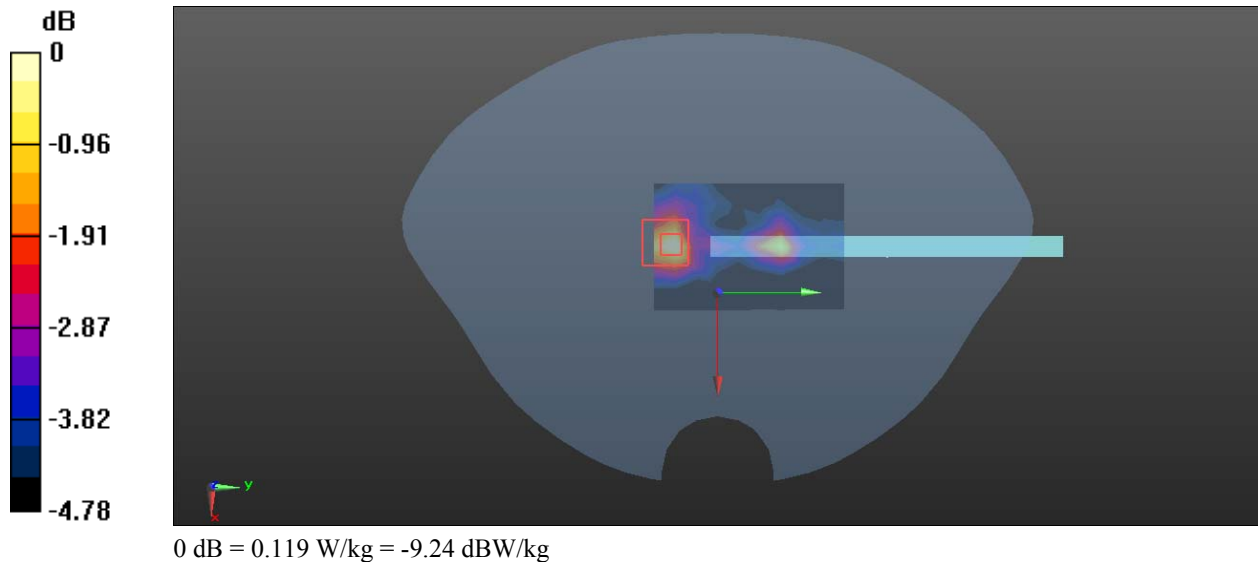

**Plot 6#: 5.2G WIFI Mid\_ Body Bottom****DUT: Tablet PC; Type: W120; Serial: 2BIJ-1**

Communication System: 802.11 a (0); Frequency: 5200 MHz; Duty Cycle: 1:1.031  
Medium parameters used:  $f = 5200$  MHz;  $\sigma = 4.515$  S/m;  $\epsilon_r = 36.638$ ;  $\rho = 1000$  kg/m<sup>3</sup>  
Phantom section: Flat Section

DASY5 Configuration:

- Probe: EX3DV4 - SN7522; ConvF(5.36, 5.36, 5.36) @ 5200 MHz; Calibrated: 2023/5/29
- Sensor-Surface: 1.4mm (Mechanical Surface Detection)
- Electronics: DAE4 Sn1354; Calibrated: 2022/10/31
- Phantom: Twin SAM; Type: Twin SAM V5.0; Serial: TP:1470
- Measurement SW: DASY52, Version 52.10 (2); SEMCAD X Version 14.6.12 (7470)

**Area Scan (7x10x1):** Measurement grid: dx=10mm, dy=10mm

Maximum value of SAR (measured) = 0.755 W/kg

**Zoom Scan (8x8x6)/Cube 0:** Measurement grid: dx=4mm, dy=4mm, dz=2mm

Reference Value = 6.791 V/m; Power Drift = -0.11 dB

Peak SAR (extrapolated) = 1.41 W/kg

**SAR(1 g) = 0.429 W/kg; SAR(10 g) = 0.182 W/kg**

Maximum value of SAR (measured) = 0.923 W/kg

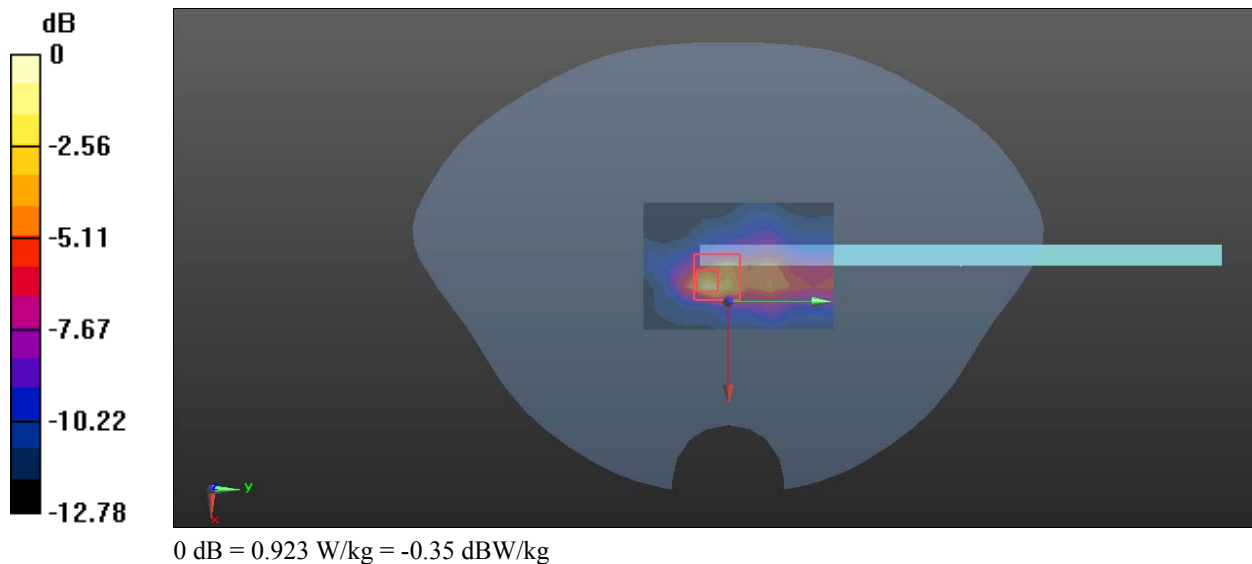

**Plot 7#: 5.8G WIFI Mid\_Body Back****DUT: Tablet PC; Type: W120; Serial: 2BIJ-1**

Communication System: 802.11 a (0); Frequency: 5785 MHz; Duty Cycle: 1:1.031  
Medium parameters used (interpolated):  $f = 5785$  MHz;  $\sigma = 5.179$  S/m;  $\epsilon_r = 35.314$ ;  $\rho = 1000$  kg/m<sup>3</sup>  
Phantom section: Flat Section

DASY5 Configuration:

- Probe: EX3DV4 - SN7522; ConvF(4.9, 4.9, 4.9) @ 5785 MHz; Calibrated: 2023/5/29
- Sensor-Surface: 1.4mm (Mechanical Surface Detection)
- Electronics: DAE4 Sn1354; Calibrated: 2022/10/31
- Phantom: Twin SAM; Type: Twin SAM V5.0; Serial: TP:1470
- Measurement SW: DASY52, Version 52.10 (2); SEMCAD X Version 14.6.12 (7470)

**Area Scan (10x10x1):** Measurement grid: dx=10mm, dy=10mm  
Maximum value of SAR (measured) = 1.24 W/kg

**Zoom Scan (8x8x6)/Cube 0:** Measurement grid: dx=4mm, dy=4mm, dz=2mm  
Reference Value = 3.440 V/m; Power Drift = 0.14 dB  
Peak SAR (extrapolated) = 1.88 W/kg  
**SAR(1 g) = 0.647 W/kg; SAR(10 g) = 0.278 W/kg**  
Maximum value of SAR (measured) = 1.24 W/kg

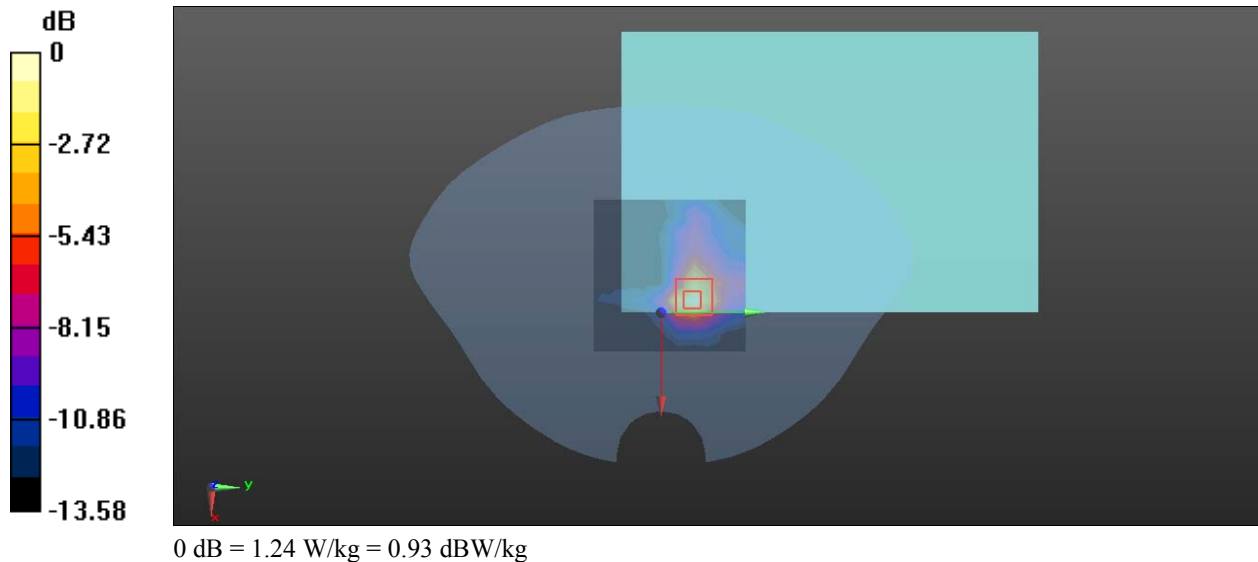

**Plot 8#: 5.8G WIFI Mid\_Body Right****DUT: Tablet PC; Type: W120; Serial: 2BIJ-1**

Communication System: 802.11 a (0); Frequency: 5785 MHz; Duty Cycle: 1:1.031  
Medium parameters used (interpolated):  $f = 5785$  MHz;  $\sigma = 5.179$  S/m;  $\epsilon_r = 35.314$ ;  $\rho = 1000$  kg/m<sup>3</sup>  
Phantom section: Flat Section

DASY5 Configuration:

- Probe: EX3DV4 - SN7522; ConvF(4.9, 4.9, 4.9) @ 5785 MHz; Calibrated: 2023/5/29
- Sensor-Surface: 1.4mm (Mechanical Surface Detection)
- Electronics: DAE4 Sn1354; Calibrated: 2022/10/31
- Phantom: Twin SAM; Type: Twin SAM V5.0; Serial: TP:1470
- Measurement SW: DASY52, Version 52.10 (2); SEMCAD X Version 14.6.12 (7470)

**Area Scan (7x10x1):** Measurement grid: dx=10mm, dy=10mm

Maximum value of SAR (measured) = 0.164 W/kg

**Zoom Scan (8x8x6)/Cube 0:** Measurement grid: dx=4mm, dy=4mm, dz=2mm

Reference Value = 4.338 V/m; Power Drift = -0.18 dB

Peak SAR (extrapolated) = 0.217 W/kg

**SAR(1 g) = 0.119 W/kg; SAR(10 g) = 0.094 W/kg**

Maximum value of SAR (measured) = 0.163 W/kg

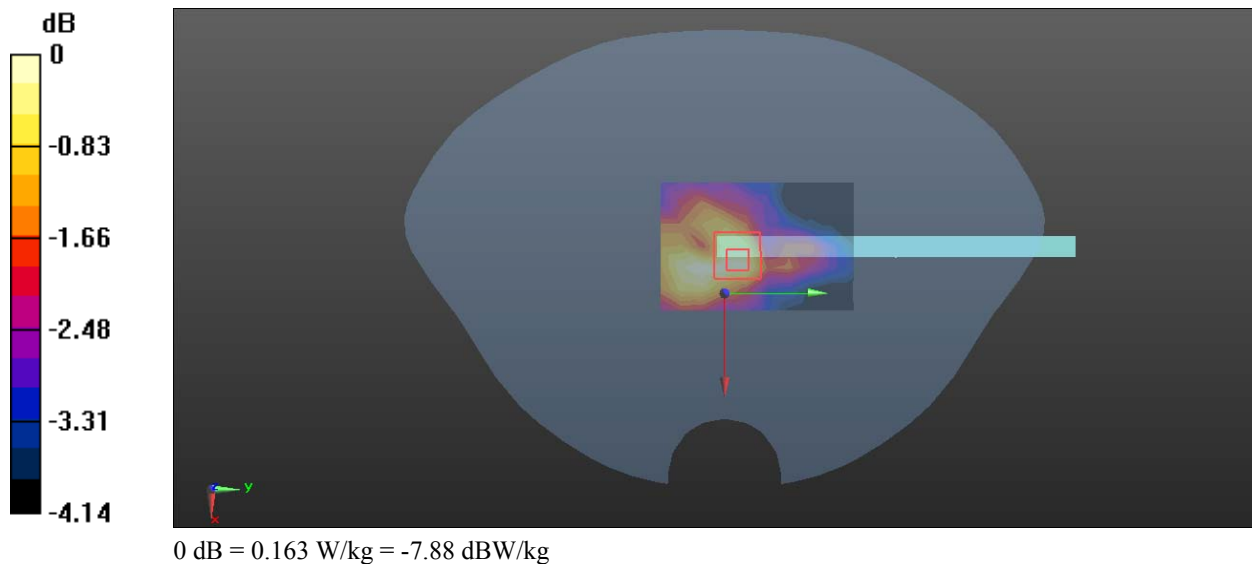

**Plot 9#: 5.8G WIFI Low\_ Body Bottom****DUT: Tablet PC; Type: W120; Serial: 2BIJ-1**

Communication System: 802.11 a (0); Frequency: 5745 MHz; Duty Cycle: 1:1.031  
Medium parameters used (interpolated):  $f = 5745$  MHz;  $\sigma = 5.143$  S/m;  $\epsilon_r = 35.414$ ;  $\rho = 1000$  kg/m<sup>3</sup>  
Phantom section: Flat Section

DASY5 Configuration:

- Probe: EX3DV4 - SN7522; ConvF(4.9, 4.9, 4.9) @ 5745 MHz; Calibrated: 2023/5/29
- Sensor-Surface: 1.4mm (Mechanical Surface Detection)
- Electronics: DAE4 Sn1354; Calibrated: 2022/10/31
- Phantom: Twin SAM; Type: Twin SAM V5.0; Serial: TP:1470
- Measurement SW: DASY52, Version 52.10 (2); SEMCAD X Version 14.6.12 (7470)

**Area Scan (7x10x1):** Measurement grid: dx=10mm, dy=10mm  
Maximum value of SAR (measured) = 1.74 W/kg

**Zoom Scan (8x8x6)/Cube 0:** Measurement grid: dx=4mm, dy=4mm, dz=2mm  
Reference Value = 5.272 V/m; Power Drift = -0.12 dB  
Peak SAR (extrapolated) = 3.60 W/kg  
**SAR(1 g) = 1.02 W/kg; SAR(10 g) = 0.351 W/kg**  
Maximum value of SAR (measured) = 2.12 W/kg

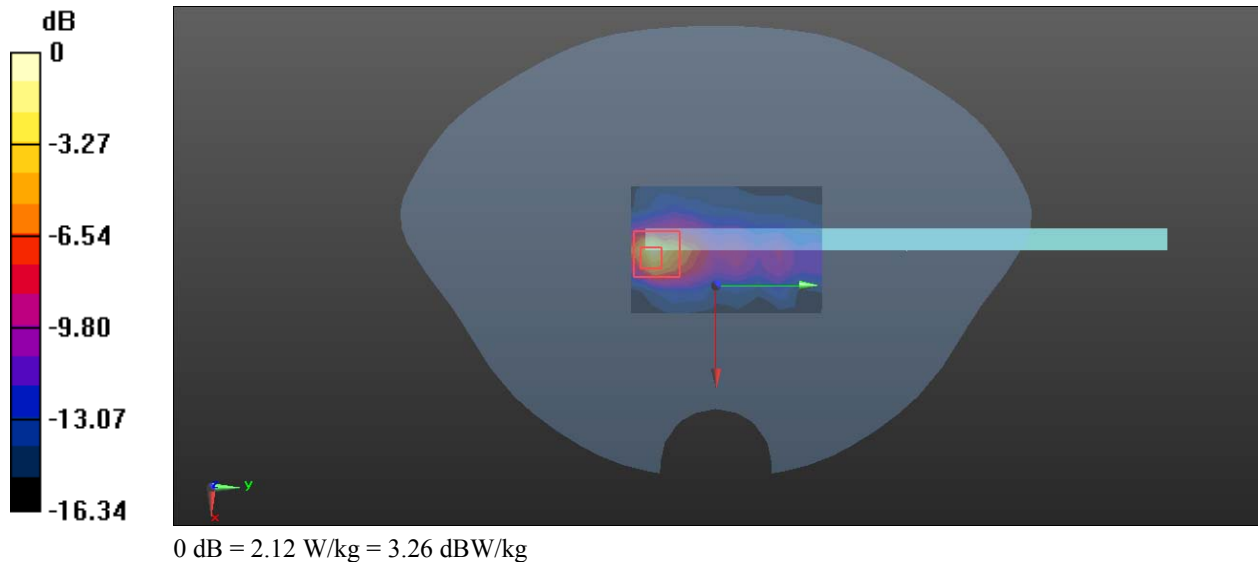

**Plot 10#: 5.8G WIFI Mid\_Body Bottom****DUT: Tablet PC; Type: W120; Serial: 2BIJ-1**

Communication System: 802.11 a (0); Frequency: 5785 MHz; Duty Cycle: 1:1.031  
Medium parameters used (interpolated):  $f = 5785$  MHz;  $\sigma = 5.179$  S/m;  $\epsilon_r = 35.314$ ;  $\rho = 1000$  kg/m<sup>3</sup>  
Phantom section: Flat Section

DASY5 Configuration:

- Probe: EX3DV4 - SN7522; ConvF(4.9, 4.9, 4.9) @ 5785 MHz; Calibrated: 2023/5/29
- Sensor-Surface: 1.4mm (Mechanical Surface Detection)
- Electronics: DAE4 Sn1354; Calibrated: 2022/10/31
- Phantom: Twin SAM; Type: Twin SAM V5.0; Serial: TP:1470
- Measurement SW: DASY52, Version 52.10 (2); SEMCAD X Version 14.6.12 (7470)

**Area Scan (7x10x1):** Measurement grid: dx=10mm, dy=10mm  
Maximum value of SAR (measured) = 2.09 W/kg

**Zoom Scan (7x7x6)/Cube 0:** Measurement grid: dx=4mm, dy=4mm, dz=2mm  
Reference Value = 5.747 V/m; Power Drift = -0.16 dB  
Peak SAR (extrapolated) = 5.06 W/kg  
**SAR(1 g) = 1.32 W/kg; SAR(10 g) = 0.434 W/kg**  
Maximum value of SAR (measured) = 2.63 W/kg

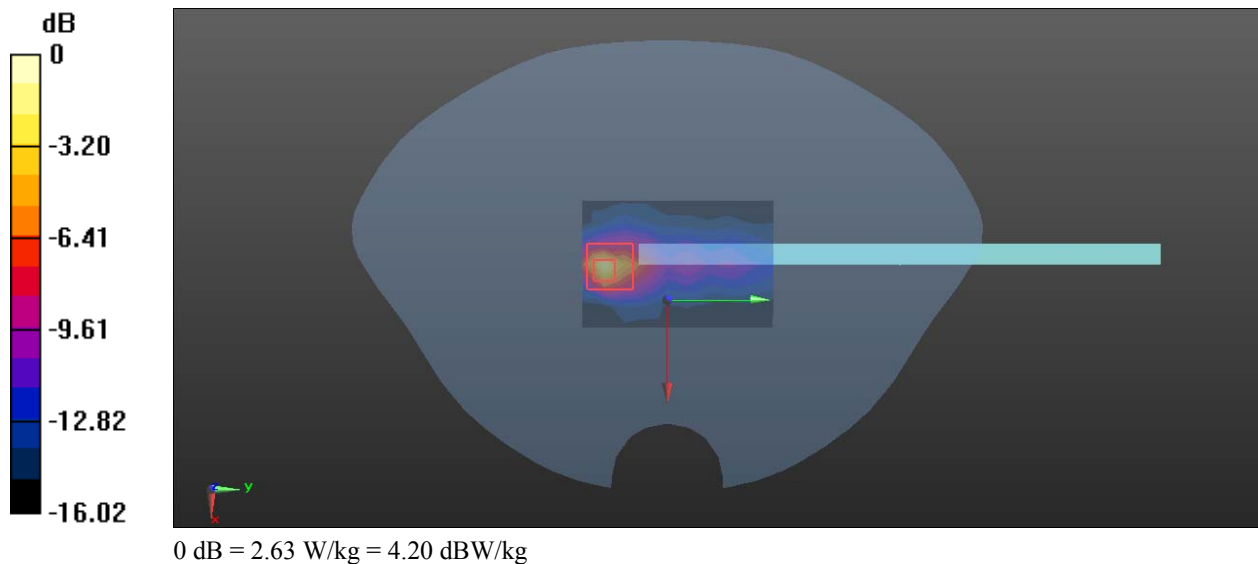

**Plot 11#: 5.8G WIFI High\_ Body Bottom****DUT: Tablet PC; Type: W120; Serial: 2B1J-1**

Communication System: 802.11 a (0); Frequency: 5825 MHz; Duty Cycle: 1:1.031  
Medium parameters used (interpolated):  $f = 5825$  MHz;  $\sigma = 5.285$  S/m;  $\epsilon_r = 35.286$ ;  $\rho = 1000$  kg/m<sup>3</sup>  
Phantom section: Flat Section

DASY5 Configuration:

- Probe: EX3DV4 - SN7522; ConvF(4.9, 4.9, 4.9) @ 5825 MHz; Calibrated: 2023/5/29
- Sensor-Surface: 1.4mm (Mechanical Surface Detection)
- Electronics: DAE4 Sn1354; Calibrated: 2022/10/31
- Phantom: Twin SAM; Type: Twin SAM V5.0; Serial: TP:1470
- Measurement SW: DASY52, Version 52.10 (2); SEMCAD X Version 14.6.12 (7470)

**Area Scan (7x10x1):** Measurement grid: dx=10mm, dy=10mm

Maximum value of SAR (measured) = 0.892 W/kg

**Zoom Scan (7x7x6)/Cube 0:** Measurement grid: dx=4mm, dy=4mm, dz=2mm

Reference Value = 7.310 V/m; Power Drift = -0.12 dB

Peak SAR (extrapolated) = 2.23 W/kg

**SAR(1 g) = 0.733 W/kg; SAR(10 g) = 0.302 W/kg**

Maximum value of SAR (measured) = 1.56 W/kg

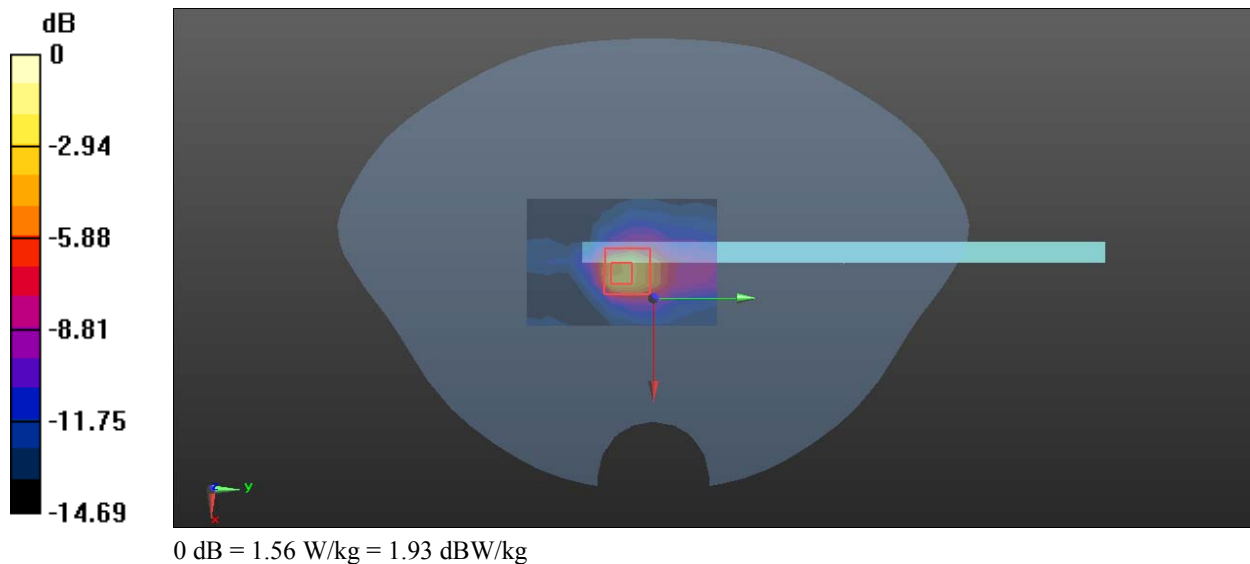

## APPENDIX A MEASUREMENT UNCERTAINTY

The uncertainty budget has been determined for the measurement system and is given in the following Table.

### Measurement uncertainty evaluation for IEEE1528-2013 SAR test

Source of uncertainty	Tolerance/ uncertainty ± %	Probability distribution	Divisor	ci (1 g)	ci (10 g)	Standard uncertainty ± %, (1 g)	Standard uncertainty ± %, (10 g)
<b>Measurement system</b>							
Probe calibration	6.55	N	1	1	1	6.3	6.3
Axial Isotropy	4.7	R	$\sqrt{3}$	1	1	2.7	2.7
Hemispherical Isotropy	9.6	R	$\sqrt{3}$	0	0	0.0	0.0
Boundary effect	1.0	R	$\sqrt{3}$	1	1	0.6	0.6
Linearity	4.7	R	$\sqrt{3}$	1	1	2.7	2.7
Detection limits	1.0	R	$\sqrt{3}$	1	1	0.6	0.6
Readout electronics	0.3	N	1	1	1	0.3	0.3
Response time	0.0	R	$\sqrt{3}$	1	1	0.0	0.0
Integration time	0.0	R	$\sqrt{3}$	1	1	0.0	0.0
RF ambient conditions – noise	1.0	R	$\sqrt{3}$	1	1	0.6	0.6
RF ambient conditions– reflections	1.0	R	$\sqrt{3}$	1	1	0.6	0.6
Probe positioner mech. Restrictions	0.8	R	$\sqrt{3}$	1	1	0.5	0.5
Probe positioning with respect to phantom shell	6.7	R	$\sqrt{3}$	1	1	3.9	3.9
Post-processing	2.0	R	$\sqrt{3}$	1	1	1.2	1.2
<b>Test sample related</b>							
Test sample positioning	2.8	N	1	1	1	2.8	2.8
Device holder uncertainty	6.3	N	1	1	1	6.3	6.3
Drift of output power	5.0	R	$\sqrt{3}$	1	1	2.9	2.9
<b>Phantom and set-up</b>							
Phantom uncertainty (shape and thickness tolerances)	4.0	R	$\sqrt{3}$	1	1	2.3	2.3
Liquid conductivity target)	5.0	R	$\sqrt{3}$	0.64	0.43	1.8	1.2
Liquid conductivity meas.)	2.5	N	1	0.64	0.43	1.6	1.1
Liquid permittivity target)	5.0	R	$\sqrt{3}$	0.6	0.49	1.7	1.4
Liquid permittivity meas.)	2.5	N	1	0.6	0.49	1.5	1.2
Combined standard uncertainty		RSS				12.2	12.0
Expanded uncertainty 95 % confidence interval)						24.1	23.7



## Measurement uncertainty evaluation for IEC62209-1 SAR test

Source of uncertainty	Tolerance/uncertainty ± %	Probability distribution	Divisor	ci (1 g)	ci (10 g)	Standard uncertainty ± %, (1 g)	Standard uncertainty ± %, (10 g)
<b>Measurement system</b>							
Probe calibration	6.55	N	1	1	1	6.3	6.3
Axial Isotropy	4.7	R	√3	1	1	2.7	2.7
Hemispherical Isotropy	9.6	R	√3	0	0	0.0	0.0
Boundary effect	1.0	R	√3	1	1	0.6	0.6
Linearity	4.7	R	√3	1	1	2.7	2.7
Detection limits	1.0	R	√3	1	1	0.6	0.6
Readout electronics	0.3	N	1	1	1	0.3	0.3
Response time	0.0	R	√3	1	1	0.0	0.0
Integration time	0.0	R	√3	1	1	0.0	0.0
RF ambient conditions – noise	1.0	R	√3	1	1	0.6	0.6
Probe positioning with respect to phantom shell	6.7	R	√3	1	1	3.9	3.9
Probe positioner mech. Restrictions	0.8	R	√3	1	1	0.5	0.5
RF ambient conditions– reflections	1.0	R	√3	1	1	0.6	0.6
Post-processing	2.0	R	√3	1	1	1.2	1.2
<b>Test sample related</b>							
Test sample positioning	2.8	N	1	1	1	2.8	2.8
Device holder uncertainty	6.3	N	1	1	1	6.3	6.3
Drift of output power	5.0	R	√3	1	1	2.9	2.9
<b>Phantom and set-up</b>							
Phantom uncertainty (shape and thickness tolerances)	4.0	R	√3	1	1	2.3	2.3
Liquid conductivity target)	5.0	R	√3	0.64	0.43	1.8	1.2
Liquid conductivity meas.)	2.5	N	1	0.64	0.43	1.6	1.1
Liquid permittivity target)	5.0	R	√3	0.6	0.49	1.7	1.4
Liquid permittivity meas.)	2.5	N	1	0.6	0.49	1.5	1.2
Combined standard uncertainty		RSS				12.2	12.0
Expanded uncertainty 95 % confidence interval)						24.0	23.6

## **APPENDIX B EUT TEST POSITION PHOTOS**

---

**Please Refer to the Attachment.**

---

## **APPENDIX C CALIBRATION CERTIFICATES**

---

**Please Refer to the Attachment.**

**\*\*\*\*\* END OF REPORT \*\*\*\*\***