



**中认信通**  
CHINA CERTIFICATION ICT CO., LTD (DONGGUAN)



## TEST REPORT

**Applicant:** CHITECH SHENZHEN TECHNOLOGY CO.,LTD

Address: 101,NO.48,Xiashijia Road,Gongming Town,Guangming  
Dist.,Shenzhen,China

**FCC ID:** 2AXUI-W120

**Product Name:** Tablet PC

**Standard(s):** 47 CFR Part 15, Subpart E(15.407)  
ANSI C63.10-2013  
KDB 789033 D02 General U-NII Test Procedures New  
Rules v02r01

The above device has been tested and found compliant with the requirement of the relative standards by China Certification ICT Co., Ltd (Dongguan)

**Report Number:** CR230952638-00E

**Date Of Issue:** 2023/9/21

**Reviewed By:** Calvin Chen

Title: RF Engineer

**Approved By:** Sun Zhong

Title: Manager

**Test Laboratory:** China Certification ICT Co., Ltd (Dongguan)

No. 113, Pingkang Road, Dalang Town, Dongguan,  
Guangdong, China  
Tel: +86-769-82016888

## Test Facility

The Test site used by China Certification ICT Co., Ltd (Dongguan) to collect test data is located on the No. 113, Pingkang Road, Dalang Town, Dongguan, Guangdong, China.

The lab has been recognized as the FCC accredited lab under the KDB 974614 D01 and is listed in the FCC Public Access Link (PAL) database, FCC Registration No. : 442868, the FCC Designation No. : CN1314.

The lab has been recognized by Innovation, Science and Economic Development Canada to test to Canadian radio equipment requirements, the CAB identifier: CN0123.

## Declarations

China Certification ICT Co., Ltd (Dongguan) is not responsible for the authenticity of any test data provided by the applicant. Data included from the applicant that may affect test results are marked with a triangle symbol “▲”. Customer model name, addresses, names, trademarks etc. are not considered data.

Unless otherwise stated the results shown in this test report refer only to the sample(s) tested.

This report cannot be reproduced except in full, without prior written approval of the Company.

This report is valid only with a valid digital signature. The digital signature may be available only under the Adobe software above version 7.0.

This report may contain data that are not covered by the accreditation scope and shall be marked with an asterisk “★”.

## CONTENTS

<b>DOCUMENT REVISION HISTORY .....</b>	<b>5</b>
<b>1. GENERAL INFORMATION .....</b>	<b>6</b>
<b>1.1 PRODUCT DESCRIPTION FOR EQUIPMENT UNDER TEST (EUT) .....</b>	<b>6</b>
<b>1.2 DESCRIPTION OF TEST CONFIGURATION.....</b>	<b>9</b>
1.2.1 EUT Operation Condition:.....	9
1.2.2 Support Equipment List and Details .....	10
1.2.3 Support Cable List and Details .....	10
1.2.4 Block Diagram of Test Setup.....	10
<b>1.3 MEASUREMENT UNCERTAINTY .....</b>	<b>11</b>
<b>2. SUMMARY OF TEST RESULTS .....</b>	<b>12</b>
<b>3. REQUIREMENTS AND TEST PROCEDURES .....</b>	<b>13</b>
<b>3.1 AC LINE CONDUCTED EMISSIONS.....</b>	<b>13</b>
3.1.1 Applicable Standard.....	13
3.1.2 EUT Setup.....	14
3.1.3 EMI Test Receiver Setup .....	14
3.1.4 Test Procedure .....	15
3.1.5 Corrected Amplitude & Margin Calculation.....	15
<b>3.2 RADIATION SPURIOUS EMISSIONS.....</b>	<b>16</b>
3.2.1 Applicable Standard.....	16
3.2.2 EUT Setup.....	17
3.2.3 EMI Test Receiver & Spectrum Analyzer Setup .....	17
3.2.4 Test Procedure .....	18
3.2.5 Corrected Amplitude & Margin Calculation.....	18
<b>3.3 EMISSION BANDWIDTH.....</b>	<b>19</b>
3.3.1 Applicable Standard.....	19
3.3.2 EUT Setup.....	19
3.3.3 Test Procedure .....	19
<b>3.4 MAXIMUM CONDUCTED OUTPUT POWER.....</b>	<b>21</b>
3.4.1 Applicable Standard.....	21
3.4.2 EUT Setup.....	21
3.4.3 Test Procedure .....	21
<b>3.5 MAXIMUM POWER SPECTRAL DENSITY .....</b>	<b>22</b>
3.5.1 Applicable Standard.....	22
3.5.2 EUT Setup.....	22
3.5.3 Test Procedure .....	23
<b>3.7 DUTY CYCLE .....</b>	<b>24</b>
3.7.1 EUT Setup.....	24
3.7.2 Test Procedure .....	24
<b>3.8 ANTENNA REQUIREMENT.....</b>	<b>25</b>
3.8.1 Applicable Standard.....	25
3.8.2 Judgment.....	25

**4. Test DATA AND RESULTS..... 26**

**4.1 AC LINE CONDUCTED EMISSIONS.....26**

**4.2 RADIATION SPURIOUS EMISSIONS .....29**

**4.3 EMISSION BANDWIDTH: .....46**

**4.4 MAXIMUM CONDUCTED OUTPUT POWER: .....60**

**4.5 MAXIMUM POWER SPECTRAL DENSITY: .....62**

**4.6 DUTY CYCLE:.....70**

**5. EUT PHOTOGRAPHS ..... 72**

**6. TEST SETUP PHOTOGRAPHS ..... 73**

## DOCUMENT REVISION HISTORY

Revision Number	Report Number	Description of Revision	Date of Revision
1.0	CR230952638-00E	Original Report	2023/9/21

## 1. GENERAL INFORMATION

### 1.1 Product Description for Equipment under Test (EUT)

#### 1.1.1 General:

<b>EUT Name:</b>	Tablet PC
<b>EUT Model:</b>	W120
<b>Multiple Models:</b>	F39WQ, F39W, W310, W320, W510, W520
<b>Trade Name:</b>	TIBUTA
<b>Operation Frequency:</b>	5180-5240 MHz (802.11a/n ht20/ac vht20) 5190-5230 MHz (802.11n ht40/ac vht40) 5210MHz (802.11ac vht80) 5745-5825 MHz (802.11a/n ht20/ac vht20) 5755-5795 MHz (802.11n ht40/ac vht40) 5775MHz (802.11ac vht80)
<b>Maximum Average Output Power (Conducted):</b>	13.34dBm (5150-5250 MHz) 13.55dBm (5725-5850 MHz)
<b>Modulation Type:</b>	OFDM-BPSK, QPSK, 16QAM, 64QAM,256QAM
<b>Rated Input Voltage:</b>	DC 12V from adapter or DC 7.6V from battery
<b>Serial Number:</b>	2B1F-1 (for Emissions Test) 2B1F-2 (for RF Conducted Test)
<b>EUT Received Date:</b>	2023/9/8
<b>EUT Received Status:</b>	Good
Note: The Multiple models are electrically identical with the test model. Please refer to the declaration letter for more detail, which was provided by manufacturer.	

#### 1.1.2 Operation Frequency Detail: For 802.11a/n ht20/ac vht20:

5150-5250MHz Band		5725-5850MHz Band	
Channel	Frequency (MHz)	Channel	Frequency (MHz)
36	5180	149	5745
40	5200	153	5765
44	5220	157	5785
48	5240	161	5805
/	/	165	5825
Per section 15.31(m), the below frequencies were performed the test as below:			
36	5180	149	5745
40	5200	157	5785
48	5240	165	5825

#### For 802.11n ht40/ac vht40:

5150-5250MHz Band		5725-5850MHz Band	
Channel	Frequency (MHz)	Channel	Frequency (MHz)
38	5190	151	5755
46	5230	159	5795
Per section 15.31(m), the below frequencies were performed the test as below:			
38	5190	151	5755
46	5230	159	5795



**For 802.11ac vht80:**

5150-5250MHz Band		5725-5850MHz Band	
Channel	Frequency (MHz)	Channel	Frequency (MHz)
42	5210	155	5775
Per section 15.31(m), the below frequencies were performed the test as below:			
42	5210	155	5775

**1.1.3 Antenna Information Detail ▲ :**

Antenna Type	input impedance (Ohm)	Frequency Range	Antenna Gain
FPC	50	2.4~2.5GHz	1.73 dBi
		5.0~5.85GHz	1.65 dBi

The Method of §15.203 Compliance:

- Antenna was permanently attached to the unit.  
 Antenna use a unique type of connector to attach to the EUT.  
 Unit was professionally installed, and installer shall be responsible for verifying that the correct antenna is employed with the unit.

**1.1.4 Accessory Information:**

Accessory Description	Manufacturer	Model	Parameters
Adapter	Shenzhen Sunshine Technological Co.td	XSG-1203000HUS	Input: 100-240V~50/60Hz 0.8A Output: 12V = 3A
keyboard	CHITECH	Unknown	Unknown



## 1.2 Description of Test Configuration

### 1.2.1 EUT Operation Condition:

<b>EUT Operation Mode:</b>		The system was configured for testing in Engineering Mode, which was provided by the manufacturer.		
<b>Equipment Modifications:</b>		No		
<b>EUT Exercise Software:</b>		QRCT.exe		
The software was provided by manufacturer. The maximum power was configured as below, that was provided by the manufacturer ▲:				
<b>5150-5250 MHz Band:</b>				
Test Modes	Test Channels	Test Frequency (MHz)	Data rate	Power Level Setting
802.11a	Lowest	5180	6Mbps	17
	Middle	5200	6Mbps	17
	Highest	5240	6Mbps	17
802.11n ht20	Lowest	5180	MCS0	16
	Middle	5200	MCS0	16
	Highest	5240	MCS0	16
802.11n ht40	Lowest	5190	MCS0	16
	Highest	5230	MCS0	16
802.11ac vht80	Middle	5210	MCS0	12
<b>5725-5850 MHz Band:</b>				
Test Modes	Test Channels	Test Frequency (MHz)	Data rate	Power Level Setting
802.11a	Lowest	5745	6Mbps	17
	Middle	5785	6Mbps	17
	Highest	5825	6Mbps	17
802.11n ht20	Lowest	5745	MCS0	16
	Middle	5785	MCS0	16
	Highest	5825	MCS0	16
802.11n ht40	Lowest	5755	MCS0	16
	Highest	5795	MCS0	16
802.11ac vht80	Middle	5775	MCS0	12
Note: The system support 802.11a/n ht20/n ht40/ac vht20/vht40/vht80, the vht20/vht40 were reduced since the identical parameters with 802.11n ht20 and ht40. The above are the worst-case data rates, which are determined for each mode based upon investigations by measuring the average power and PSD across all data rates, bandwidths, and modulations.				

### 1.2.2 Support Equipment List and Details

Manufacturer	Description	Model	Serial Number
Unknown	keyboard	Unknown	Unknown
DongFeng	Phone	P3	UP3_BSGF187E000165
PHILIPS	Monitor	24PFF5595/T3	XM2A2124000343
PHILIPS	Mouse	SPK7214	M214BQ210411615
IPRO	Earphone	Phonenix 5.0s	EP221126001
SanDisk	TF Card	32 GB	521005904698

### 1.2.3 Support Cable List and Details

Cable Description	Shielding Type	Ferrite Core	Length (m)	From Port	To
HDMI Cable	No	No	1	EUT	Monitor
USB Cable	No	No	0.8	EUT	Phone
Mouse Cable	No	No	1.2	EUT	Mouse
Earphone Cable	No	No </tr			

### 1.2.4 Block Diagram of Test Setup

AC line conducted emissions:

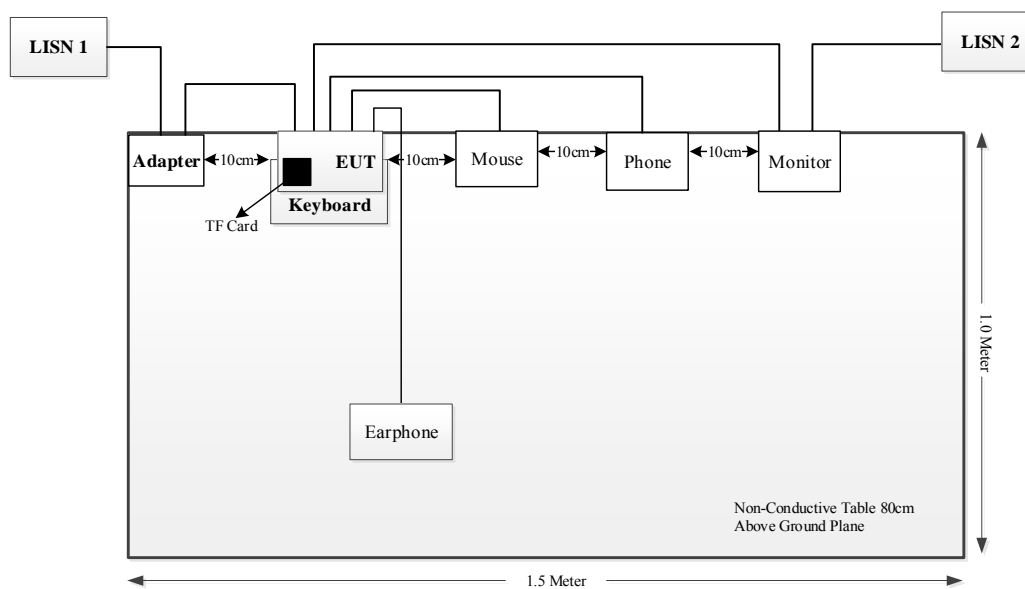

Spurious Emissions:

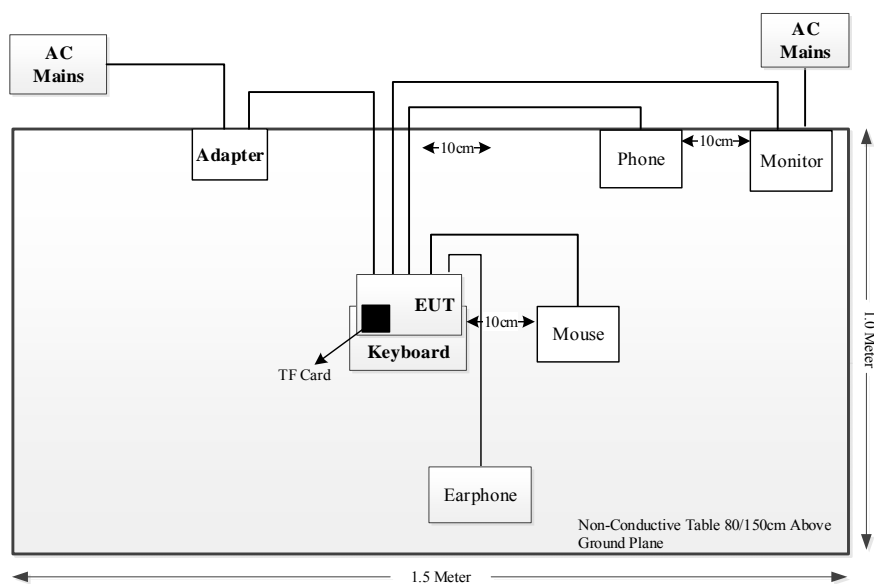

### 1.3 Measurement Uncertainty

Otherwise required by the applicant or Product Regulations, Decision Rule in this report did not consider the uncertainty. The extended uncertainty given in this report is obtained by combining the standard uncertainty times the coverage factor K with the 95% confidence interval.

Parameter	Measurement Uncertainty
Occupied Channel Bandwidth	±5 %
RF output power, conducted	±0.61 dB
Power Spectral Density, conducted	±0.61 dB
Unwanted Emissions, radiated	30M~200MHz: 4.15 dB, 200M~1GHz: 5.61 dB, 1G~6GHz: 5.14 dB, 6G~18GHz: 5.93 dB, 18G~26.5G: 5.47 dB, 26.5G~40G: 5.63 dB
Unwanted Emissions, conducted	±1.26 dB
Temperature	±1 °C
Humidity	±5%
DC and low frequency voltages	±0.4%
Duty Cycle	1%
AC Power Lines Conducted Emission	2.8 dB (150 kHz to 30 MHz)

## 2. SUMMARY OF TEST RESULTS

Standard(s) Section	Test Items	Result
FCC§15.207(a)	AC line conducted emissions	Compliant
FCC§15.205& §15.209 &§15.407(b)	Radiated Spurious Emissions	Compliant
FCC§15.407 (c)	Automatically Discontinue Transmission	Compliant*
FCC§15.407(a) (e)	Emission Bandwidth	Compliant
FCC§15.407(a)	Maximum Conducted Output Power	Compliant
FCC§15.407 (a)	Power Spectral Density	Compliant
FCC§15.407 (g)	Frequency Stability	Compliant**
§15.203	Antenna Requirement	Compliant

**Note:**

**Compliant\*:** During no any information transmission, the EUT can automatically discontinue transmission and become standby mode for power saving. the EUT can detect the controlling signal of ACK message transmitting from remote device and verify whether it shall resend or discontinue transmission.

**Compliant\*\*:** Grantee ensure that the product meets e-CFR Title 47 section 15.407(g) and KDB 789033 D02v02r01 frequency stability such that the emissions are maintained within the band of operation under all conditions of normal operation as specified in the user's manual.

### 3. REQUIREMENTS AND TEST PROCEDURES

#### 3.1 AC Line Conducted Emissions

##### 3.1.1 Applicable Standard

FCC§15.207(a).

(a) Except as shown in paragraphs (b) and (c) of this section, for an intentional radiator that is designed to be connected to the public utility (AC) power line, the radio frequency voltage that is conducted back onto the AC power line on any frequency or frequencies, within the band 150 kHz to 30 MHz, shall not exceed the limits in the following table, as measured using a 50  $\mu$ H/50 ohms line impedance stabilization network (LISN). Compliance with the provisions of this paragraph shall be based on the measurement of the radio frequency voltage between each power line and ground at the power terminal. The lower limit applies at the boundary between the frequency ranges.

Frequency of emission (MHz)	Conducted limit (dB $\mu$ V)	
	Quasi-peak	Average
0.15-0.5	66 to 56*	56 to 46*
0.5-5	56	46
5-30	60	50

\*Decreases with the logarithm of the frequency.

(b) The limit shown in paragraph (a) of this section shall not apply to carrier current systems operating as intentional radiators on frequencies below 30 MHz. In lieu thereof, these carrier current systems shall be subject to the following standards:

(1) For carrier current system containing their fundamental emission within the frequency band 535-1705 kHz and intended to be received using a standard AM broadcast receiver: no limit on conducted emissions.

(2) For all other carrier current systems: 1000  $\mu$ V within the frequency band 535-1705 kHz, as measured using a 50  $\mu$ H/50 ohms LISN.

(3) Carrier current systems operating below 30 MHz are also subject to the radiated emission limits in §15.205, §15.209, §15.221, §15.223, or §15.227, as appropriate.

(c) Measurements to demonstrate compliance with the conducted limits are not required for devices which only employ battery power for operation and which do not operate from the AC power lines or contain provisions for operation while connected to the AC power lines. Devices that include, or make provisions for, the use of battery chargers which permit operating while charging, AC adapters or battery eliminators or that connect to the AC power lines indirectly, obtaining their power through another device which is connected to the AC power lines, shall be tested to demonstrate compliance with the conducted limits.

### 3.1.2 EUT Setup

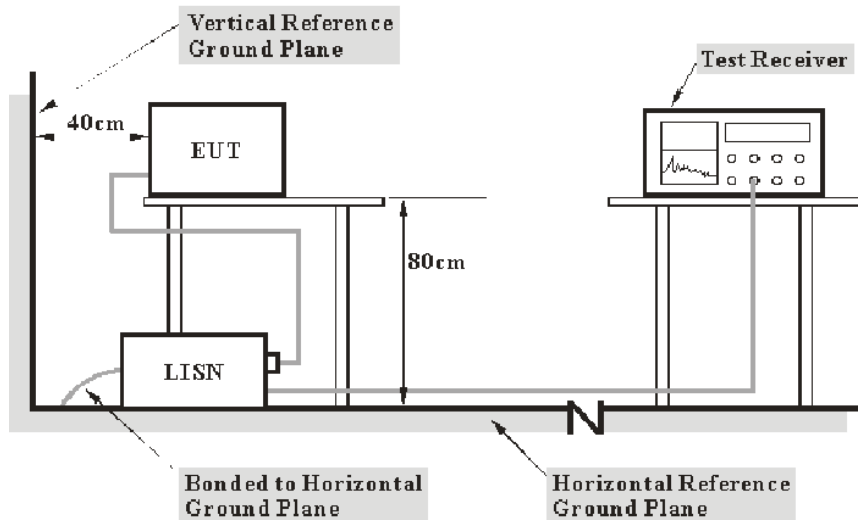

- Note: 1. Support units were connected to second LISN.  
 2. Both of LISNs (AMN) 80 cm from EUT and at the least 80 cm from other units and other metal planes support units.

The setup of EUT is according with per ANSI C63.10-2013 measurement procedure. The specification used was with the FCC Part 15.207 limits.

The spacing between the peripherals was 10 cm.

The adapter or EUT was connected to the main LISN with a 120 V/60 Hz AC power source.

### 3.1.3 EMI Test Receiver Setup

The EMI test receiver was set to investigate the spectrum from 150 kHz to 30 MHz.

During the conducted emission test, the EMI test receiver was set with the following configurations:

Frequency Range	IF B/W
150 kHz – 30 MHz	9 kHz

### 3.1.4 Test Procedure

The frequency and amplitude of the six highest ac power-line conducted emissions relative to the limit, measured over all the current-carrying conductors of the EUT power cords, and the operating frequency or frequency to which the EUT is tuned (if appropriate), should be reported, unless such emissions are more than 20 dB below the limit. AC power-line conducted emissions measurements are to be separately carried out only on each of the phase (“hot”) line(s) and (if used) on the neutral line(s), but not on the ground [protective earth] line(s). If less than six emission frequencies are within 20 dB of the limit, then the noise level of the measuring instrument at representative frequencies should be reported. The specific conductor of the power-line cord for each of the reported emissions should be identified. Measure the six highest emissions with respect to the limit on each current-carrying conductor of each power cord associated with the EUT (but not the power cords of associated or peripheral equipment that are part of the test configuration). Then, report the six highest emissions with respect to the limit from among all the measurements identifying the frequency and specific current-carrying conductor identified with the emission. The six highest emissions should be reported for each of the current-carrying conductors, or the six highest emissions may be reported over all the current-carrying conductors.

### 3.1.5 Corrected Amplitude & Margin Calculation

The basic equation is as follows:

Result = Reading + Factor

Factor = attenuation caused by cable loss + voltage division factor of AMN

The “**Margin**” column of the following data tables indicates the degree of compliance within the applicable limit. The equation for margin calculation is as follows:

Margin = Limit – Result

## 3.2 Radiation Spurious Emissions

### 3.2.1 Applicable Standard

FCC §15.407 (b);

*Undesirable emission limits.* Except as shown in paragraph (b)(7) of this section, the maximum emissions outside of the frequency bands of operation shall be attenuated in accordance with the following limits:

(1) For transmitters operating in the 5.15-5.25 GHz band: All emissions outside of the 5.15-5.35 GHz band shall not exceed an e.i.r.p. of - 27 dBm/MHz.

(2) For transmitters operating in the 5.25-5.35 GHz band: All emissions outside of the 5.15-5.35 GHz band shall not exceed an e.i.r.p. of - 27 dBm/MHz.

(3) For transmitters operating in the 5.47-5.725 GHz band: All emissions outside of the 5.47-5.725 GHz band shall not exceed an e.i.r.p. of - 27 dBm/MHz.

(4) For transmitters operating solely in the 5.725-5.850 GHz band:

(i) All emissions shall be limited to a level of - 27 dBm/MHz at 75 MHz or more above or below the band edge increasing linearly to 10 dBm/MHz at 25 MHz above or below the band edge, and from 25 MHz above or below the band edge increasing linearly to a level of 15.6 dBm/MHz at 5 MHz above or below the band edge, and from 5 MHz above or below the band edge increasing linearly to a level of 27 dBm/MHz at the band edge.

(ii) Devices certified before March 2, 2017 with antenna gain greater than 10 dBi may demonstrate compliance with the emission limits in § 15.247(d), but manufacturing, marketing and importing of devices certified under this alternative must cease by March 2, 2018. Devices certified before March 2, 2018 with antenna gain of 10 dBi or less may demonstrate compliance with the emission limits in § 15.247(d), but manufacturing, marketing and importing of devices certified under this alternative must cease before March 2, 2020.

(8) The emission measurements shall be performed using a minimum resolution bandwidth of 1 MHz. A lower resolution bandwidth may be employed near the band edge, when necessary, provided the measured energy is integrated to show the total power over 1 MHz.

(9) Unwanted emissions below 1 GHz must comply with the general field strength limits set forth in § 15.209. Further, any U-NII devices using an AC power line are required to comply also with the conducted limits set forth in § 15.207.

(10) The provisions of § 15.205 apply to intentional radiators operating under this section.

(11) When measuring the emission limits, the nominal carrier frequency shall be adjusted as close to the upper and lower frequency band edges as the design of the equipment permits.

(c) The device shall automatically discontinue transmission in case of either absence of information to transmit or operational failure. These provisions are not intended to preclude the transmission of control or signalling information or the use of repetitive codes used by certain digital technologies to complete frame or burst intervals. Applicants shall include in their application for equipment authorization a description of how this requirement is met.



### 3.2.2 EUT Setup

#### Below 1GHz:

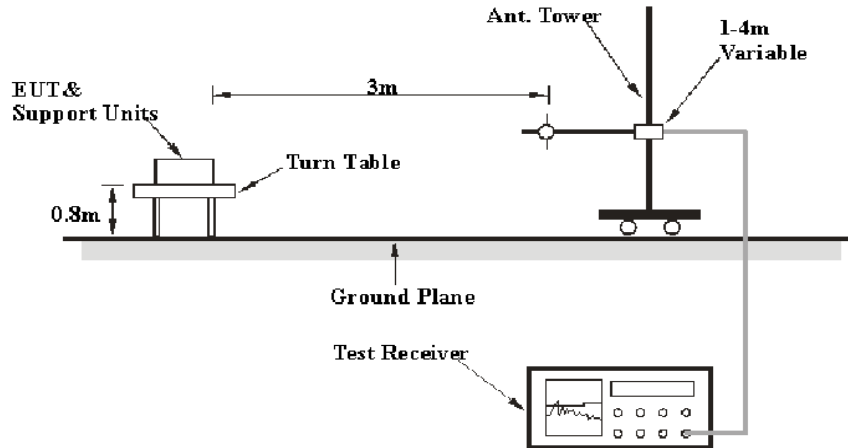

#### 1-40 GHz:

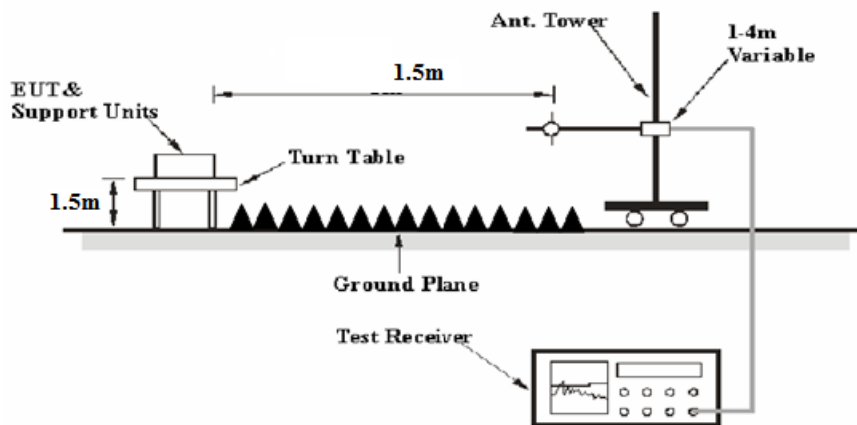

The radiated emission tests were performed in the 3 meters chamber test site, using the setup accordance with the ANSI C63.10-2013. The specification used was FCC 15.209, FCC 15.407 limits.

The external I/O cables were draped along the test table and formed a bundle 30 to 40 cm long in the middle.

The spacing between the peripherals was 10 cm.

### 3.2.3 EMI Test Receiver & Spectrum Analyzer Setup

The system was investigated from 30 MHz to 40 GHz.

During the radiated emission test, the EMI test receiver & Spectrum Analyzer Setup were set with the following configurations:

30MHz-1000MHz:

Measurement	RBW	Video B/W	IF B/W
QP	120 kHz	300 kHz	120kHz

1GHz- 40GHz:

Measurement	Duty cycle	RBW	Video B/W
PK	Any	1MHz	3 MHz
AV	>98%	1MHz	10 Hz
	<98%	1MHz	$\geq 1/T$

Note: T is minimum transmission duration

If the maximized peak measured value complies with under the QP/Average limit more than 6dB, then it is unnecessary to perform an QP/Average measurement.

### 3.2.4 Test Procedure

During the radiated emission test, the adapter was connected to the first AC floor outlet.

Data was recorded in Quasi-peak detection mode for frequency range of 30 MHz-1GHz, peak and Average detection modes for frequencies above 1GHz.

According to KDB 789033 D02 General UNII Test Procedures New Rules v02r01, emission shall be computed as:  $E [dB\mu V/m] = EIRP [dBm] + 95.2$ , for  $d = 3$  meters.

According to C63.10, the above 1G test result shall be extrapolated to the specified distance using an extrapolation Factor of 20dB/decade from 3m to 1.5m

Distance extrapolation Factor =  $20 \log (\text{specific distance } [3m] / \text{test distance } [1.5m])$  dB = 6.02 dB

All emissions under the average limit and under the noise floor have not recorded in the report.

### 3.2.5 Corrected Amplitude & Margin Calculation

The basic equation is as follows:

Factor = Antenna Factor + Cable Loss - Amplifier Gain

For 30MHz-1GHz:

Result = Reading + Factor

For 1GHz-40GHz

Result = Reading + Factor - Distance extrapolation Factor

The “**Margin**” column of the following data tables indicates the degree of compliance within the applicable limit. The equation for margin calculation is as follows:

Margin = Limit – Result

### 3.3 Emission Bandwidth

#### 3.3.1 Applicable Standard

FCC §15.407 (a),(h)

(h)(2) Radar Detection Function of Dynamic Frequency Selection (DFS). U-NII devices operating with any part of its 26 dB emission bandwidth in the 5.25-5.35 GHz and 5.47-5.725 GHz bands shall employ a DFS radar detection mechanism to detect the presence of radar systems and to avoid co-channel operation with radar systems.

FCC §15.407 (e)

Within the 5.725-5.850 GHz and 5.850-5.895 GHz bands, the minimum 6 dB bandwidth of U-NII devices shall be at least 500 kHz.

#### 3.3.2 EUT Setup

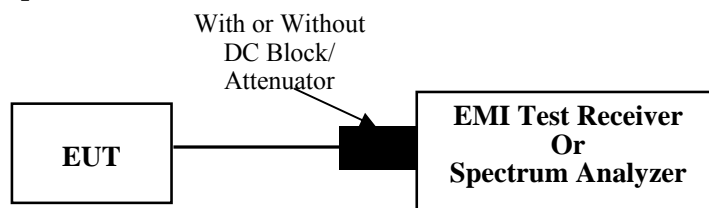

#### 3.3.3 Test Procedure

##### 26dB Emission Bandwidth:

According to ANSI C63.10-2013 Section 12.4.1

- Set RBW = approximately 1% of the emission bandwidth.
- Set the VBW > RBW.
- Detector = peak.
- Trace mode = max hold
- Measure the maximum width of the emission that is 26 dB down from the peak of the emission. Compare this with the RBW setting of the instrument. Readjust RBW and repeat measurement as needed until the RBW/EBW ratio is approximately 1%.

##### 6 dB emission bandwidth:

According to KDB 789033 D02 General UNII Test Procedures New Rules v02r01

- Set RBW = 100 kHz.
- Set the video bandwidth (VBW)  $\geq 3$  RBW.
- Detector = Peak.
- Trace mode = max hold.
- Sweep = auto couple.
- Allow the trace to stabilize.
- Measure the maximum width of the emission that is constrained by the frequencies associated with the two outermost amplitude points (upper and lower frequencies) that are attenuated by 6 dB relative to the maximum level measured in the fundamental emission.

Note: The automatic bandwidth measurement capability of a spectrum analyzer or EMI receiver may be employed if it implements the functionality described in this section. For devices that use channel aggregation refer to III.A and III.C for determining emission bandwidth.

**99% Occupied Bandwidth:**

According to ANSI C63.10-2013 Section 12.4.2&6.9.3

The occupied bandwidth is the frequency bandwidth such that, below its lower and above its upper frequency limits, the mean powers are each equal to 0.5% of the total mean power of the given emission. The following procedure shall be used for measuring 99% power bandwidth:

- a) The instrument center frequency is set to the nominal EUT channel center frequency. The frequency span for the spectrum analyzer shall be between 1.5 times and 5.0 times the OBW.
- b) The nominal IF filter bandwidth (3 dB RBW) shall be in the range of 1% to 5% of the OBW, and VBW shall be approximately three times the RBW, unless otherwise specified by the applicable requirement.
- c) Set the reference level of the instrument as required, keeping the signal from exceeding the maximum input mixer level for linear operation. In general, the peak of the spectral envelope shall be more than  $[10 \log (OBW/RBW)]$  below the reference level. Specific guidance is given in 4.1.5.2.
- d) Step a) through step c) might require iteration to adjust within the specified range.
- e) Video averaging is not permitted. Where practical, a sample detection and single sweep mode shall be used. Otherwise, peak detection and max hold mode (until the trace stabilizes) shall be used.
- f) Use the 99% power bandwidth function of the instrument (if available) and report the measured bandwidth.
- g) If the instrument does not have a 99% power bandwidth function, then the trace data points are recovered and directly summed in linear power terms. The recovered amplitude data points, beginning at the lowest frequency, are placed in a running sum until 0.5% of the total is reached; that frequency is recorded as the lower frequency. The process is repeated until 99.5% of the total is reached; that frequency is recorded as the upper frequency. The 99% power bandwidth is the difference between these two frequencies.
- h) The occupied bandwidth shall be reported by providing plot(s) of the measuring instrument display; the plot axes and the scale units per division shall be clearly labeled. Tabular data may be reported in addition to the plot(s).

### 3.4 Maximum Conducted Output Power

#### 3.4.1 Applicable Standard

##### FCC §15.407(a) (1)(iv)

For client devices in the 5.15-5.25 GHz band, the maximum conducted output power over the frequency band of operation shall not exceed 250 mW provided the maximum antenna gain does not exceed 6 dBi. In addition, the maximum power spectral density shall not exceed 11 dBm in any 1 megahertz band. If transmitting antennas of directional gain greater than 6 dBi are used, both the maximum conducted output power and the maximum power spectral density shall be reduced by the amount in dB that the directional gain of the antenna exceeds 6 dBi.

##### FCC §15.407(a) (2)

For the 5.25-5.35 GHz and 5.47-5.725 GHz bands, the maximum conducted output power over the frequency bands of operation shall not exceed the lesser of 250 mW or  $11 \text{ dBm} + 10 \log B$ , where B is the 26 dB emission bandwidth in megahertz. In addition, the maximum power spectral density shall not exceed 11 dBm in any 1 megahertz band. If transmitting antennas of directional gain greater than 6 dBi are used, both the maximum conducted output power and the maximum power spectral density shall be reduced by the amount in dB that the directional gain of the antenna exceeds 6 dBi.

##### FCC §15.407(a) (3)(i)

For the band 5.725-5.850 GHz, the maximum conducted output power over the frequency band of operation shall not exceed 1 W. In addition, the maximum power spectral density shall not exceed 30 dBm in any 500-kHz band. If transmitting antennas of directional gain greater than 6 dBi are used, both the maximum conducted output power and the maximum power spectral density shall be reduced by the amount in dB that the directional gain of the antenna exceeds 6 dBi. However, fixed point-to-point U-NII devices operating in this band may employ transmitting antennas with directional gain greater than 6 dBi without any corresponding reduction in transmitter conducted power. Fixed, point-to-point operations exclude the use of point-to-multipoint systems, omnidirectional applications, and multiple collocated transmitters transmitting the same information. The operator of the U-NII device, or if the equipment is professionally installed, the installer, is responsible for ensuring that systems employing high gain directional antennas are used exclusively for fixed, point-to-point operations.

#### 3.4.2 EUT Setup

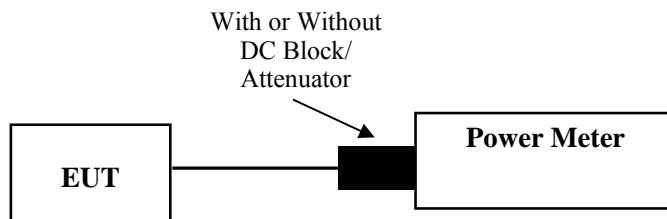

#### 3.4.3 Test Procedure

According to ANSI C63.10-2013 Section 12.3.3.1

Method PM-G is measurement using a gated RF average power meter. Measurements may be performed using a wideband gated RF power meter provided that the gate parameters are adjusted such that the power is measured only when the EUT is transmitting at its maximum power control level. Because the measurement is made only during the ON time of the transmitter, no duty cycle correction factor is required.

### 3.5 Maximum Power Spectral Density

#### 3.5.1 Applicable Standard

FCC §15.407(a) (1)(iv)

For client devices in the 5.15-5.25 GHz band, the maximum conducted output power over the frequency band of operation shall not exceed 250 mW provided the maximum antenna gain does not exceed 6 dBi. In addition, the maximum power spectral density shall not exceed 11 dBm in any 1 megahertz band. If transmitting antennas of directional gain greater than 6 dBi are used, both the maximum conducted output power and the maximum power spectral density shall be reduced by the amount in dB that the directional gain of the antenna exceeds 6 dBi.

FCC §15.407(a) (2)

For the 5.25-5.35 GHz and 5.47-5.725 GHz bands, the maximum conducted output power over the frequency bands of operation shall not exceed the lesser of 250 mW or  $11 \text{ dBm} + 10 \log B$ , where B is the 26 dB emission bandwidth in megahertz. In addition, the maximum power spectral density shall not exceed 11 dBm in any 1 megahertz band. If transmitting antennas of directional gain greater than 6 dBi are used, both the maximum conducted output power and the maximum power spectral density shall be reduced by the amount in dB that the directional gain of the antenna exceeds 6 dBi.

FCC §15.407(a) (3)(i)

For the band 5.725-5.850 GHz, the maximum conducted output power over the frequency band of operation shall not exceed 1 W. In addition, the maximum power spectral density shall not exceed 30 dBm in any 500-kHz band. If transmitting antennas of directional gain greater than 6 dBi are used, both the maximum conducted output power and the maximum power spectral density shall be reduced by the amount in dB that the directional gain of the antenna exceeds 6 dBi. However, fixed point-to-point U-NII devices operating in this band may employ transmitting antennas with directional gain greater than 6 dBi without any corresponding reduction in transmitter conducted power. Fixed, point-to-point operations exclude the use of point-to-multipoint systems, omnidirectional applications, and multiple collocated transmitters transmitting the same information. The operator of the U-NII device, or if the equipment is professionally installed, the installer, is responsible for ensuring that systems employing high gain directional antennas are used exclusively for fixed, point-to-point operations.

#### 3.5.2 EUT Setup

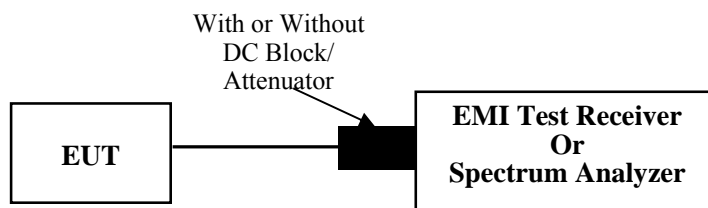

### **3.5.3 Test Procedure**

According to KDB 789033 D02 General UNII Test Procedures New Rules v02r01

#### **Duty cycle $\geq 98\%$**

KDB 789033 D02 General UNII Test Procedures New Rules v02r01 Method SA-1 should be applied.

#### **Duty cycle $< 98\%$ , duty cycle variations are less than $\pm 2\%$**

KDB 789033 D02 General UNII Test Procedures New Rules v02r01 Method SA-2 should be applied.

#### **Duty cycle $< 98\%$ , duty cycle variations exceed $\pm 2\%$**

KDB 789033 D02 General UNII Test Procedures New Rules v02r01 Method SA-3 should be applied.

### 3.7 Duty Cycle

#### 3.7.1 EUT Setup

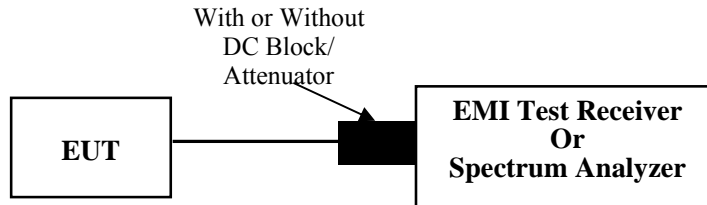

#### 3.7.2 Test Procedure

According to ANSI C63.10-2013 Section 12.2

The zero-span mode on a spectrum analyzer or EMI receiver if the response time and spacing between bins on the sweep are sufficient to permit accurate measurements of the ON and OFF times of the transmitted signal:

- 1) Set the center frequency of the instrument to the center frequency of the transmission.
- 2) Set  $RBW \geq OBW$  if possible; otherwise, set RBW to the largest available value.
- 3) Set  $VBW \geq RBW$ . Set detector = peak or average.
- 4) The zero-span measurement method shall not be used unless both RBW and VBW are  $> 50/T$  and the number of sweep points across duration T exceeds 100. (For example, if VBW and/or RBW are limited to 3 MHz, then the zero-span method of measuring the duty cycle shall not be used if  $T \leq 16.7 \mu s$ .)



## **3.8 Antenna Requirement**

### **3.8.1 Applicable Standard**

FCC §15.203

An intentional radiator shall be designed to ensure that no antenna other than that furnished by the responsible party shall be used with the device. The use of a permanently attached antenna or of an antenna that uses a unique coupling to the intentional radiator shall be considered sufficient to comply with the provisions of this section. The manufacturer may design the unit so that a broken antenna can be replaced by the user, but the use of a standard antenna jack or electrical connector is prohibited. This requirement does not apply to carrier current devices or to devices operated under the provisions of §§15.211, 15.213, 15.217, 15.219, 15.221, or §15.236. Further, this requirement does not apply to intentional radiators that must be professionally installed, such as perimeter protection systems and some field disturbance sensors, or to other intentional radiators which, in accordance with §15.31(d), must be measured at the installation site. However, the installer shall be responsible for ensuring that the proper antenna is employed so that the limits in this part are not exceeded.

### **3.8.2 Judgment**

**Result: Compliant.** Please refer to the Antenna Information detail in Section 1.

## 4. Test DATA AND RESULTS

### 4.1 AC Line Conducted Emissions

Serial Number:	2B1F-1	Test Date:	2023/09/13
Test Site:	CE	Test Mode:	Transmitting (Tested at maximum output power mode (802.11a 5745MHz ))
Tester:	Vic Du	Test Result:	Pass

#### Environmental Conditions:

Temperature: (°C)	26.1	Relative Humidity: (%)	67	ATM Pressure: (kPa)	99.6
----------------------	------	---------------------------	----	------------------------	------

#### Test Equipment List and Details:

Manufacturer	Description	Model	Serial Number	Calibration Date	Calibration Due Date
R&S	LISN	ENV216	101134	2023/03/31	2024/03/30
R&S	LISN	ENV216	101132	2023/03/31	2024/03/30
R&S	EMI Test Receiver	ESR3	102726	2023/03/31	2024/03/30
MICRO-COAX	Coaxial Cable	UTIFLEX	C-0200-01	2023/08/06	2024/08/05
Audix	Test Software	E3	190306 (V9)	N/A	N/A

\* Statement of Traceability: China Certification ICT Co., Ltd (Dongguan) attests that all calibrations have been performed, traceable to National Primary Standards and International System of Units (SI).

#### Test Data:

Please refer to the below plots.

Project No.: CR230952638-RF  
 Tester: Vic Du  
 Port: Line  
 Note:

Date: 2023-09-13

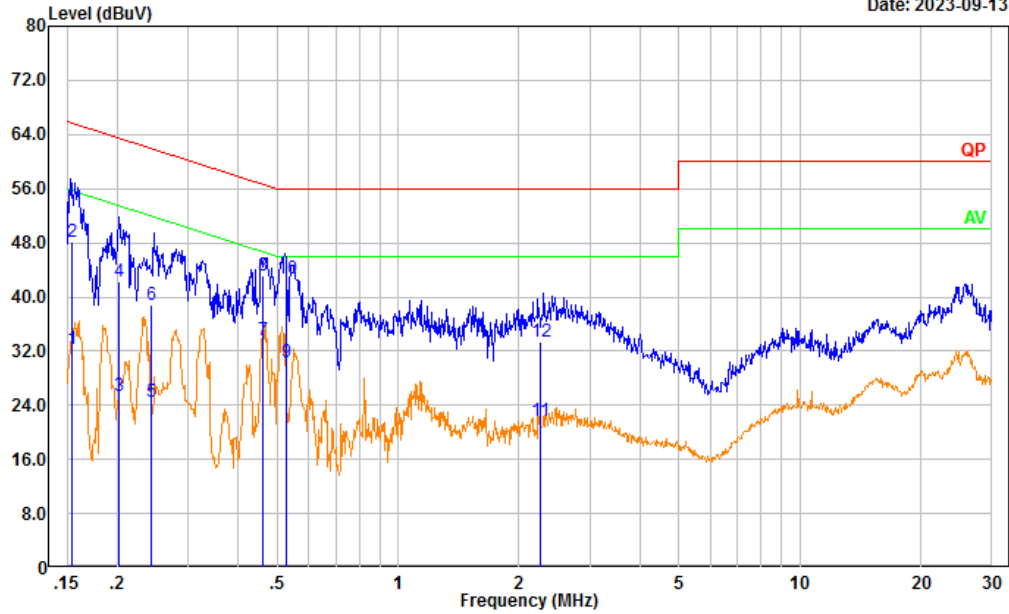

No.	Frequency (MHz)	Reading (dBμV)	Factor (dB)	Result (dBμV)	Limit (dBμV)	Margin (dB)	Detector
1	0.154	22.71	9.61	32.32	55.79	23.47	Average
2	0.154	38.50	9.61	48.11	65.79	17.68	QP
3	0.202	15.72	9.61	25.33	53.51	28.18	Average
4	0.202	32.60	9.61	42.21	63.51	21.30	QP
5	0.244	14.96	9.61	24.57	51.96	27.39	Average
6	0.244	29.16	9.61	38.77	61.96	23.19	QP
7	0.462	23.99	9.61	33.60	46.66	13.06	Average
8	0.462	33.49	9.61	43.10	56.66	13.56	QP
9	0.526	20.77	9.61	30.38	46.00	15.62	Average
10	0.526	33.17	9.61	42.78	56.00	13.22	QP
11	2.262	12.14	9.64	21.78	46.00	24.22	Average
12	2.262	23.72	9.64	33.36	56.00	22.64	QP

Project No.: CR230952638-RF  
 Tester: Vic Du  
 Port: neutral  
 Note:

Date: 2023-09-13

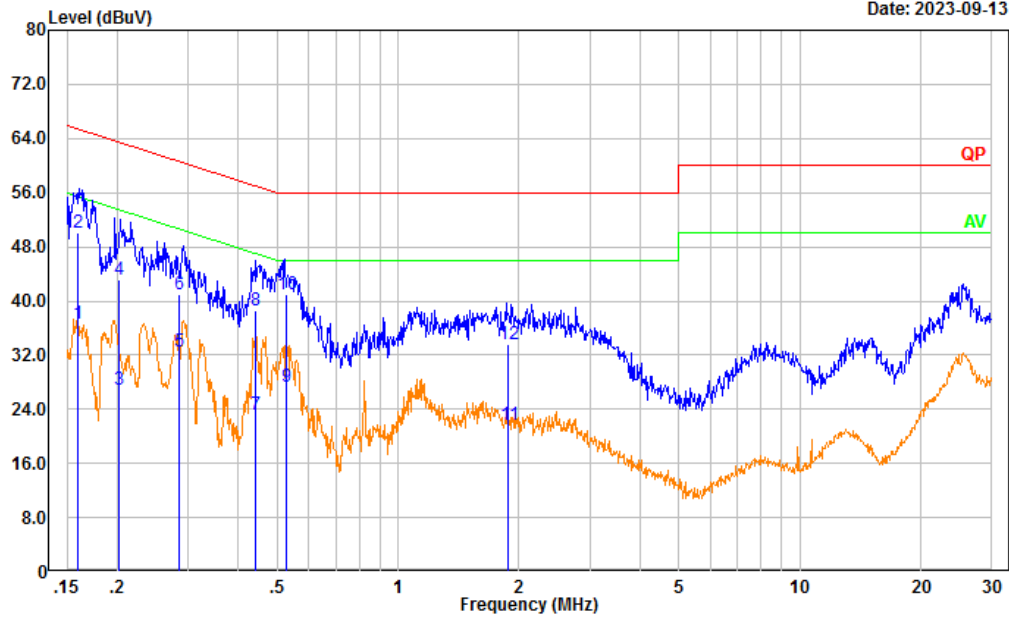

No.	Frequency (MHz)	Reading (dBμV)	Factor (dB)	Result (dBμV)	Limit (dBμV)	Margin (dB)	Detector
1	0.159	27.01	9.61	36.62	55.50	18.88	Average
2	0.159	40.42	9.61	50.03	65.50	15.47	QP
3	0.202	17.21	9.61	26.82	53.52	26.70	Average
4	0.202	33.55	9.61	43.16	63.52	20.36	QP
5	0.285	22.90	9.61	32.51	50.66	18.15	Average
6	0.285	31.36	9.61	40.97	60.66	19.69	QP
7	0.441	13.53	9.61	23.14	47.04	23.90	Average
8	0.441	28.99	9.61	38.60	57.04	18.44	QP
9	0.527	17.81	9.61	27.42	46.00	18.58	Average
10	0.527	31.35	9.61	40.96	56.00	15.04	QP
11	1.885	12.08	9.63	21.71	46.00	24.29	Average
12	1.885	24.03	9.63	33.66	56.00	22.34	QP

## 4.2 Radiation Spurious Emissions

Serial Number:	2B1F-1	Test Date:	2023/9/13~2023/9/15
Test Site:	966-2,966-1	Test Mode:	Transmitting
Tester:	Hugo Huo, Tao Zhu	Test Result:	Pass

### Environmental Conditions:

Temperature: (°C)	25.5~25.9	Relative Humidity: (%)	61~62.7	ATM Pressure: (kPa)	100~100.1
----------------------	-----------	---------------------------	---------	------------------------	-----------

### Test Equipment List and Details:

Manufacturer	Description	Model	Serial Number	Calibration Date	Calibration Due Date
EMCO	Passive Loop Antenna	6512	9706-1209	2023/02/15	2026/02/14
Sunol Sciences	Antenna	JB6	A082520-5	2020/10/19	2023/10/18
R&S	EMI Test Receiver	ESR3	102724	2023/3/31	2024/3/30
TIMES MICROWAVE	Coaxial Cable	LMR-600-UltraFlex	C-0470-02	2023/7/16	2024/7/15
TIMES MICROWAVE	Coaxial Cable	LMR-600-UltraFlex	C-0780-01	2023/7/16	2024/7/15
Sonoma	Amplifier	310N	186165	2023/7/16	2024/7/15
ETS-Lindgren	Horn Antenna	3115	9912-5985	2020/10/13	2023/10/12
R&S	Spectrum Analyzer	FSV40	101591	2023/3/31	2024/3/30
MICRO-COAX	Coaxial Cable	UFA210A-1-1200-70U300	217423-008	2023/8/6	2024/8/5
MICRO-COAX	Coaxial Cable	UFA210A-1-2362-300300	235780-001	2023/8/6	2024/8/5
Mini	Pre-amplifier	ZVA-183-S+	5969001149	2022/11/9	2023/11/8
Audix	Test Software	E3	201021 (V9)	N/A	N/A
PASTERNAK	Horn Antenna	PE9852/2F-20	112002	2021/2/5	2024/2/4
Quinstar	Preamplifier	QLW-18405536-JO	15964001005	2022/9/16	2023/9/15
MICRO-COAX	Coaxial Cable	UFB142A-1-2362-200200	235772-001	2023/8/6	2024/8/5
E-Microwave	Band Rejection Filter	5150-5850MHz	OE01902423	2023/8/6	2024/8/5
Mini Circuits	High Pass Filter	VHF-6010+	31119	2023/8/6	2024/8/5
PASTERNAK	Horn Antenna	PE9850/2F-20	072001	2021/2/5	2024/2/4

\* Statement of Traceability: China Certification ICT Co., Ltd (Dongguan) attests that all calibrations have been performed, traceable to National Primary Standards and International System of Units (SI).

**Test Data:**

Please refer to the below table and plots.

The maximum value of the main wave on the X-axis:104.93dB $\mu$ V\*(worst case position)

The maximum value of the main wave on the Y-axis: 104.69dB $\mu$ V

The maximum value of the main wave on the Z-axis:103.89dB $\mu$ V

(The pre-scan preformed on 802.11n ht20 mode 5825MHz)

After pre-scan in the X, Y and Z axes of orientation, the worst case X is below:

**1) 9kHz~30MHz**

The amplitude of spurious emissions attenuated more than 20 dB below the permissible value is not required to be report.

2) 30MHz-1GHz (Tested at maximum output power mode (802.11a 5745MHz ))

Project No.: CR230952638-RF  
 Tester: Hugo Huo  
 Polarization: horizontal  
 Note:

Date: 2023-09-13

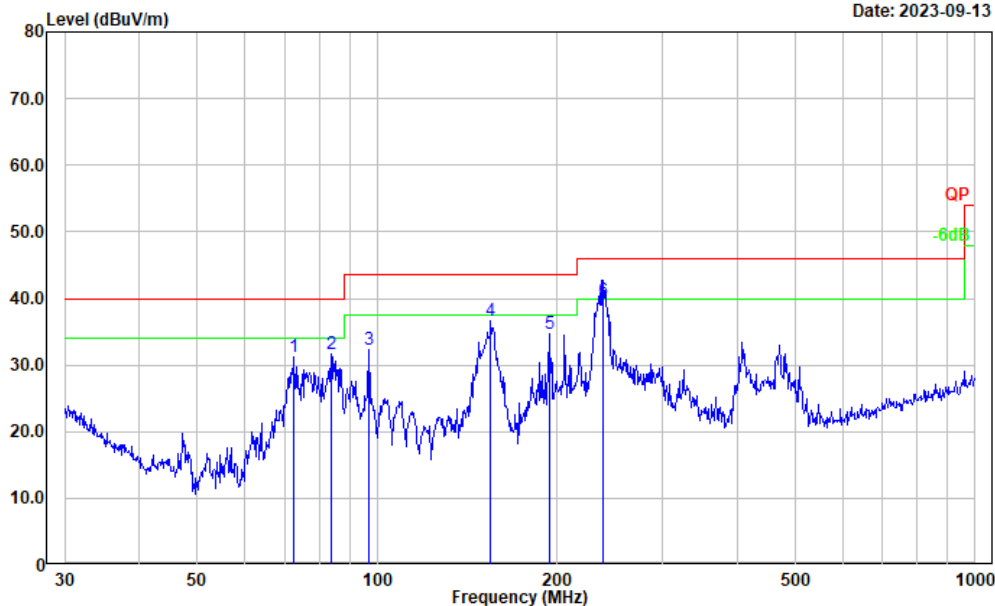

No.	Frequency (MHz)	Reading (dBμV)	Factor (dB/m)	Result (dBμV/m)	Limit (dBμV/m)	Margin (dB)	Detector
1	72.592	47.94	-16.71	31.23	40.00	8.77	Peak
2	83.816	48.82	-17.24	31.58	40.00	8.42	Peak
3	96.775	47.45	-15.13	32.32	43.50	11.18	Peak
4	154.821	48.67	-12.05	36.62	43.50	6.88	Peak
5	193.773	47.64	-12.96	34.68	43.50	8.82	Peak
6	239.147	52.81	-13.03	39.78	46.00	6.22	QP

Project No.: CR230952638-RF  
 Tester: Hugo Huo  
 Polarization: vertical  
 Note:

Date: 2023-09-13

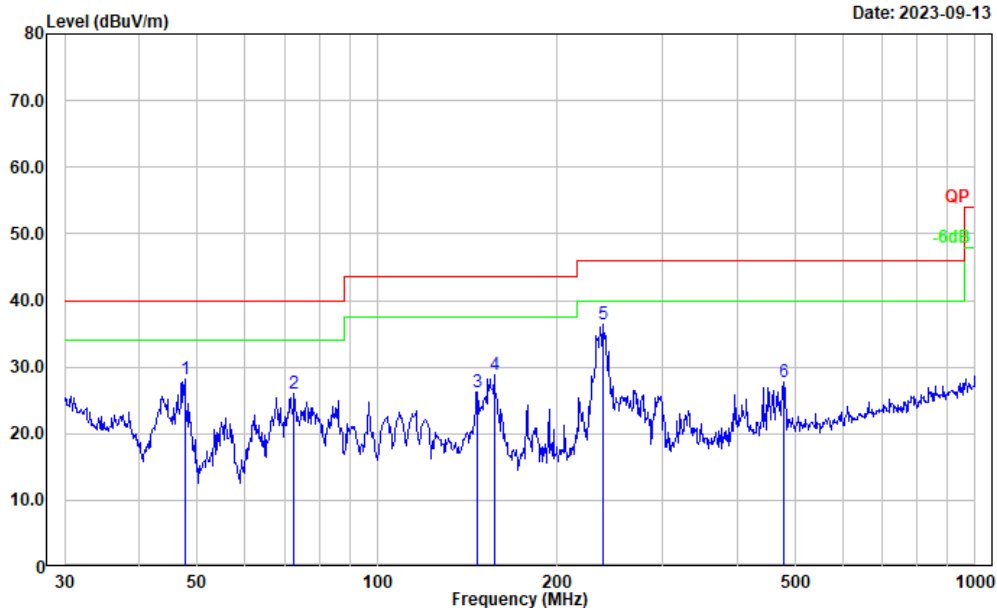

No.	Frequency (MHz)	Reading (dBμV)	Factor (dB/m)	Result (dBμV/m)	Limit (dBμV/m)	Margin (dB)	Detector
1	47.659	43.92	-15.83	28.09	40.00	11.91	Peak
2	72.592	42.72	-16.71	26.01	40.00	13.99	Peak
3	146.888	38.30	-11.98	26.32	43.50	17.18	Peak
4	157.007	40.79	-12.04	28.75	43.50	14.75	Peak
5	239.147	49.45	-13.03	36.42	46.00	9.58	Peak
6	478.846	33.99	-6.26	27.73	46.00	18.27	Peak



**3) 1GHz-40GHz:****5150-5250MHz****802.11a:**

Frequency (MHz)	Receiver		Polar (H/V)	Factor (dB/m)	Result (dB $\mu$ V/m)	Limit (dB $\mu$ V/m)	Margin (dB)
	Reading (dB $\mu$ V)	Detector					
Low Channel:				5180	MHz		
5180.000	69.33	PK	H	32.65	101.98	N/A	N/A
5180.000	58.76	AV	H	32.65	91.41	N/A	N/A
5180.000	72.66	PK	V	32.65	105.31	N/A	N/A
5180.000	61.87	AV	V	32.65	94.52	N/A	N/A
5150.000	36.36	PK	V	32.62	68.98	74.00	5.02
5150.000	18.50	AV	V	32.62	51.12	54.00	2.88
10360.000	33.86	PK	V	13.16	47.02	68.20	21.18
15540.000	35.54	PK	V	16.42	51.96	74.00	22.04
15540.000	22.25	AV	V	16.42	38.67	54.00	15.33
Middle Channel:				5200	MHz		
5200.000	70.12	PK	H	32.68	102.80	N/A	N/A
5200.000	59.35	AV	H	32.68	92.03	N/A	N/A
5200.000	72.54	PK	V	32.68	105.22	N/A	N/A
5200.000	61.55	AV	V	32.68	94.23	N/A	N/A
10400.000	33.89	PK	V	13.14	47.03	68.20	21.17
15600.000	36.90	PK	V	16.39	53.29	74.00	20.71
15600.000	23.53	AV	V	16.39	39.92	54.00	14.08
High Channel:				5240	MHz		
5240.000	70.11	PK	H	32.83	102.94	N/A	N/A
5240.000	59.37	AV	H	32.83	92.20	N/A	N/A
5240.000	73.52	PK	V	32.83	106.35	N/A	N/A
5240.000	62.53	AV	V	32.83	95.36	N/A	N/A
5350.000	29.69	PK	V	33.01	62.70	74.00	11.30
5350.000	16.44	AV	V	33.01	49.45	54.00	4.55
10480.000	33.67	PK	V	12.84	46.51	68.20	21.69
15720.000	38.63	PK	V	16.26	54.89	74.00	19.11
15720.000	25.40	AV	V	16.26	41.66	54.00	12.34

**802.11n ht20:**

Frequency (MHz)	Receiver		Polar (H/V)	Factor (dB/m)	Result (dB $\mu$ V/m)	Limit (dB $\mu$ V/m)	Margin (dB)
	Reading (dB $\mu$ V)	Detector					
Low Channel: 5180 MHz							
5180.000	69.32	PK	H	32.65	101.97	N/A	N/A
5180.000	58.44	AV	H	32.65	91.09	N/A	N/A
5180.000	72.09	PK	V	32.65	104.74	N/A	N/A
5180.000	61.17	AV	V	32.65	93.82	N/A	N/A
5150.000	36.10	PK	V	32.62	68.72	74.00	5.28
5150.000	17.07	AV	V	32.62	49.69	54.00	4.31
10360.000	34.21	PK	V	13.16	47.37	68.20	20.83
15540.000	34.69	PK	V	16.42	51.11	74.00	22.89
15540.000	21.28	AV	V	16.42	37.70	54.00	16.30
Middle Channel: 5200 MHz							
5200.000	70.25	PK	H	32.68	102.93	N/A	N/A
5200.000	59.28	AV	H	32.68	91.96	N/A	N/A
5200.000	72.58	PK	V	32.68	105.26	N/A	N/A
5200.000	61.43	AV	V	32.68	94.11	N/A	N/A
10400.000	33.65	PK	V	13.14	46.79	68.20	21.41
15600.000	36.94	PK	V	16.39	53.33	74.00	20.67
15600.000	23.47	AV	V	16.39	39.86	54.00	14.14
High Channel: 5240 MHz							
5240.000	70.55	PK	H	32.83	103.38	N/A	N/A
5240.000	59.68	AV	H	32.83	92.51	N/A	N/A
5240.000	73.26	PK	V	32.83	106.09	N/A	N/A
5240.000	62.28	AV	V	32.83	95.11	N/A	N/A
5350.000	30.02	PK	V	33.01	63.03	74.00	10.97
5350.000	16.66	AV	V	33.01	49.67	54.00	4.33
10480.000	33.25	PK	V	12.84	46.09	68.20	22.11
15720.000	38.62	PK	V	16.26	54.88	74.00	19.12
15720.000	25.47	AV	V	16.26	41.73	54.00	12.27

**802.11n ht40:**

Frequency (MHz)	Receiver		Polar (H/V)	Factor (dB/m)	Result (dB $\mu$ V/m)	Limit (dB $\mu$ V/m)	Margin (dB)
	Reading (dB $\mu$ V)	Detector					
Low Channel: 5190 MHz							
5190.000	66.25	PK	H	32.67	98.92	N/A	N/A
5190.000	55.47	AV	H	32.67	88.14	N/A	N/A
5190.000	69.66	PK	V	32.67	102.33	N/A	N/A
5190.000	58.05	AV	V	32.67	90.72	N/A	N/A
5150.000	35.49	PK	V	32.62	68.11	74.00	5.89
5150.000	18.26	AV	V	32.62	50.88	54.00	3.12
10380.000	34.77	PK	V	13.15	47.92	68.20	20.28
15570.000	34.82	PK	V	16.41	51.23	74.00	22.77
15570.000	21.62	AV	V	16.41	38.03	54.00	15.97
High Channel: 5230 MHz							
5230.000	66.71	PK	H	32.79	99.50	N/A	N/A
5230.000	56.20	AV	H	32.79	88.99	N/A	N/A
5230.000	70.12	PK	V	32.79	102.91	N/A	N/A
5230.000	59.74	AV	V	32.79	92.53	N/A	N/A
5350.000	30.74	PK	V	33.01	63.75	74.00	10.25
5350.000	17.21	AV	V	33.01	50.22	54.00	3.78
10460.000	33.87	PK	V	12.92	46.79	68.20	21.41
15690.000	39.12	PK	V	16.27	55.39	74.00	18.61
15690.000	26.59	AV	V	16.27	42.86	54.00	11.14

**802.11ac80:**

Frequency (MHz)	Receiver		Polar (H/V)	Factor (dB/m)	Result (dB $\mu$ V/m)	Limit (dB $\mu$ V/m)	Margin (dB)
	Reading (dB $\mu$ V)	Detector					
Middle Channel: 5210 MHz							
5210.000	63.49	PK	H	32.72	96.21	N/A	N/A
5210.000	50.23	AV	H	32.72	82.95	N/A	N/A
5210.000	66.23	PK	V	32.72	98.95	N/A	N/A
5210.000	53.68	AV	V	32.72	86.40	N/A	N/A
5150.000	34.47	PK	V	32.62	67.09	74.00	6.91
5150.000	17.59	AV	V	32.62	50.21	54.00	3.79
5350.000	29.48	PK	V	33.01	62.49	74.00	11.51
5350.000	16.78	AV	V	33.01	49.79	54.00	4.21
10420.000	33.37	PK	V	13.07	46.44	68.20	21.76
15630.000	36.82	PK	V	16.35	53.17	74.00	20.83
15630.000	23.72	AV	V	16.35	40.07	54.00	13.93

Note:

Result = Reading + Factor- Distance extrapolation Factor

Distance extrapolation Factor =  $20 \log(\text{specific distance [3m]}/\text{test distance [1.5m]})$  dB = 6.02 dB

**5725-5850MHz:****802.11a:**

Frequency (MHz)	Receiver		Polar (H/V)	Factor (dB/m)	Result (dB $\mu$ V/m)	Limit (dB $\mu$ V/m)	Margin (dB)
	Reading (dB $\mu$ V)	Detector					
Low Channel: 5745 MHz							
5745.000	69.74	PK	H	33.44	103.18	N/A	N/A
5745.000	58.45	AV	H	33.44	91.89	N/A	N/A
5745.000	72.66	PK	V	33.44	106.10	N/A	N/A
5745.000	61.80	AV	V	33.44	95.24	N/A	N/A
5725.000	33.55	PK	V	33.46	67.01	122.20	55.19
5720.000	31.44	PK	V	33.47	64.91	110.80	45.89
5700.000	29.56	PK	V	33.49	63.05	105.20	42.15
5650.000	29.38	PK	V	33.47	62.85	68.20	5.35
11490.000	33.38	PK	V	14.65	48.03	74.00	25.97
11490.000	20.41	AV	V	14.65	35.06	54.00	18.94
17235.000	33.75	PK	V	20.75	54.50	68.20	13.70
Middle Channel: 5785 MHz							
5785.000	68.39	PK	H	33.41	101.80	N/A	N/A
5785.000	57.42	AV	H	33.41	90.83	N/A	N/A
5785.000	71.22	PK	V	33.41	104.63	N/A	N/A
5785.000	60.35	AV	V	33.41	93.76	N/A	N/A
11570.000	34.11	PK	V	14.80	48.91	74.00	25.09
11570.000	21.29	AV	V	14.80	36.09	54.00	17.91
17355.000	33.82	PK	V	21.72	55.54	68.20	12.66
High Channel: 5825 MHz							
5825.000	68.23	PK	H	33.44	101.67	N/A	N/A
5825.000	57.46	AV	H	33.44	90.90	N/A	N/A
5825.000	71.84	PK	V	33.44	105.28	N/A	N/A
5825.000	61.38	AV	V	33.44	94.82	N/A	N/A
5850.000	31.43	PK	V	33.47	64.90	122.20	57.30
5855.000	30.96	PK	V	33.49	64.45	110.80	46.35
5875.000	30.44	PK	V	33.58	64.02	105.20	41.18
5925.000	29.23	PK	V	33.66	62.89	68.20	5.31
11650.000	34.98	PK	V	15.04	50.02	74.00	23.98
11650.000	21.78	AV	V	15.04	36.82	54.00	17.18
17475.000	33.90	PK	V	22.60	56.50	68.20	11.70

**802.11n ht20:**

Frequency (MHz)	Receiver		Polar (H/V)	Factor (dB/m)	Result (dB $\mu$ V/m)	Limit (dB $\mu$ V/m)	Margin (dB)
	Reading (dB $\mu$ V)	Detector					
Low Channel:				5745	MHz		
5745.000	68.36	PK	H	33.44	101.80	N/A	N/A
5745.000	57.48	AV	H	33.44	90.92	N/A	N/A
5745.000	71.37	PK	V	33.44	104.81	N/A	N/A
5745.000	60.43	AV	V	33.44	93.87	N/A	N/A
5725.000	36.80	PK	V	33.46	70.26	122.20	51.94
5720.000	34.06	PK	V	33.47	67.53	110.80	43.27
5700.000	29.66	PK	V	33.49	63.15	105.20	42.05
5650.000	29.32	PK	V	33.47	62.79	68.20	5.41
11490.000	34.50	PK	V	14.65	49.15	74.00	24.85
11490.000	21.65	AV	V	14.65	36.30	54.00	17.70
17235.000	34.26	PK	V	20.75	55.01	68.20	13.19
Middle Channel:				5785	MHz		
5785.000	68.26	PK	H	33.41	101.67	N/A	N/A
5785.000	57.33	AV	H	33.41	90.74	N/A	N/A
5785.000	71.25	PK	V	33.41	104.66	N/A	N/A
5785.000	60.33	AV	V	33.41	93.74	N/A	N/A
11570.000	34.08	PK	V	14.80	48.88	74.00	25.12
11570.000	21.10	AV	V	14.80	35.90	54.00	18.10
17355.000	34.98	PK	V	21.72	56.70	68.20	11.50
High Channel:				5825	MHz		
5825.000	68.74	PK	H	33.44	102.18	N/A	N/A
5825.000	57.46	AV	H	33.44	90.90	N/A	N/A
5825.000	71.49	PK	V	33.44	104.93	N/A	N/A
5825.000	60.23	AV	V	33.44	93.67	N/A	N/A
5850.000	32.86	PK	V	33.47	66.33	122.20	55.87
5855.000	31.23	PK	V	33.49	64.72	110.80	46.08
5875.000	30.40	PK	V	33.58	63.98	105.20	41.22
5925.000	29.52	PK	V	33.66	63.18	68.20	5.02
11650.000	34.41	PK	V	15.04	49.45	74.00	24.55
11650.000	21.29	AV	V	15.04	36.33	54.00	17.67
17475.000	34.58	PK	V	22.60	57.18	68.20	<b>11.02</b>

**802.11n ht40:**

Frequency (MHz)	Receiver		Polar (H/V)	Factor (dB/m)	Result (dB $\mu$ V/m)	Limit (dB $\mu$ V/m)	Margin (dB)
	Reading (dB $\mu$ V)	Detector					
Low Channel:				5755	MHz		
5755.000	65.72	PK	H	33.43	99.15	N/A	N/A
5755.000	53.69	AV	H	33.43	87.12	N/A	N/A
5755.000	68.44	PK	V	33.43	101.87	N/A	N/A
5755.000	56.96	AV	V	33.43	90.39	N/A	N/A
5725.000	35.21	PK	V	33.46	68.67	122.20	53.53
5720.000	34.18	PK	V	33.47	67.65	110.80	43.15
5700.000	34.20	PK	V	33.49	67.69	105.20	37.51
5650.000	29.35	PK	V	33.47	62.82	68.20	5.38
11510.000	33.43	PK	V	14.65	48.08	74.00	25.92
11510.000	20.58	AV	V	14.65	35.23	54.00	18.77
17265.000	33.82	PK	V	20.91	54.73	68.20	13.47
High Channel:				5795	MHz		
5795.000	65.48	PK	H	33.41	98.89	N/A	N/A
5795.000	53.20	AV	H	33.41	86.61	N/A	N/A
5795.000	68.32	PK	V	33.41	101.73	N/A	N/A
5795.000	56.34	AV	V	33.41	89.75	N/A	N/A
5850.000	39.62	PK	V	33.47	73.09	122.20	49.11
5855.000	29.66	PK	V	33.49	63.15	110.80	47.65
5875.000	29.63	PK	V	33.58	63.21	105.20	41.99
5925.000	29.47	PK	V	33.66	63.13	68.20	5.07
11590.000	33.56	PK	V	14.85	48.41	74.00	25.59
11590.000	20.47	AV	V	14.85	35.32	54.00	18.68
17385.000	33.58	PK	V	22.05	55.63	68.20	12.57

**802.11ac80 Mode:**

Frequency (MHz)	Receiver		Polar (H/V)	Factor (dB/m)	Result (dB $\mu$ V/m)	Limit (dB $\mu$ V/m)	Margin (dB)
	Reading (dB $\mu$ V)	Detector					
Middle Channel:				5775	MHz		
5775.000	62.12	PK	H	33.42	95.54	N/A	N/A
5775.000	49.63	AV	H	33.42	83.05	N/A	N/A
5775.000	63.87	PK	V	33.42	97.29	N/A	N/A
5775.000	50.63	AV	V	33.42	84.05	N/A	N/A
5724.150	30.03	PK	V	33.46	63.49	120.26	56.77
5702.621	30.82	PK	V	33.49	64.31	105.93	41.62
5668.093	30.37	PK	V	33.48	63.85	81.59	17.74
5647.935	29.97	PK	V	33.47	63.44	68.20	4.76
5851.150	30.76	PK	V	33.47	64.23	119.58	55.35
5859.252	31.54	PK	V	33.51	65.05	109.61	44.56
5883.932	31.30	PK	V	33.62	64.92	98.57	33.65
5944.394	31.44	PK	V	33.63	65.07	68.20	3.13
11550.000	33.73	PK	V	14.75	48.48	74.00	25.52
11550.000	20.17	AV	V	14.75	34.92	54.00	19.08
17325.000	33.86	PK	V	21.40	55.26	68.20	12.94

Note:

*Result = Reading + Factor- Distance extrapolation Factor*

*Distance extrapolation Factor = 20 log (specific distance [3m]/test distance [1.5m]) dB= 6.02 dB*

**The worst test plots for Band Edge Measurements (Radiated)**

802.11 ac80 5775MHz was the worst:

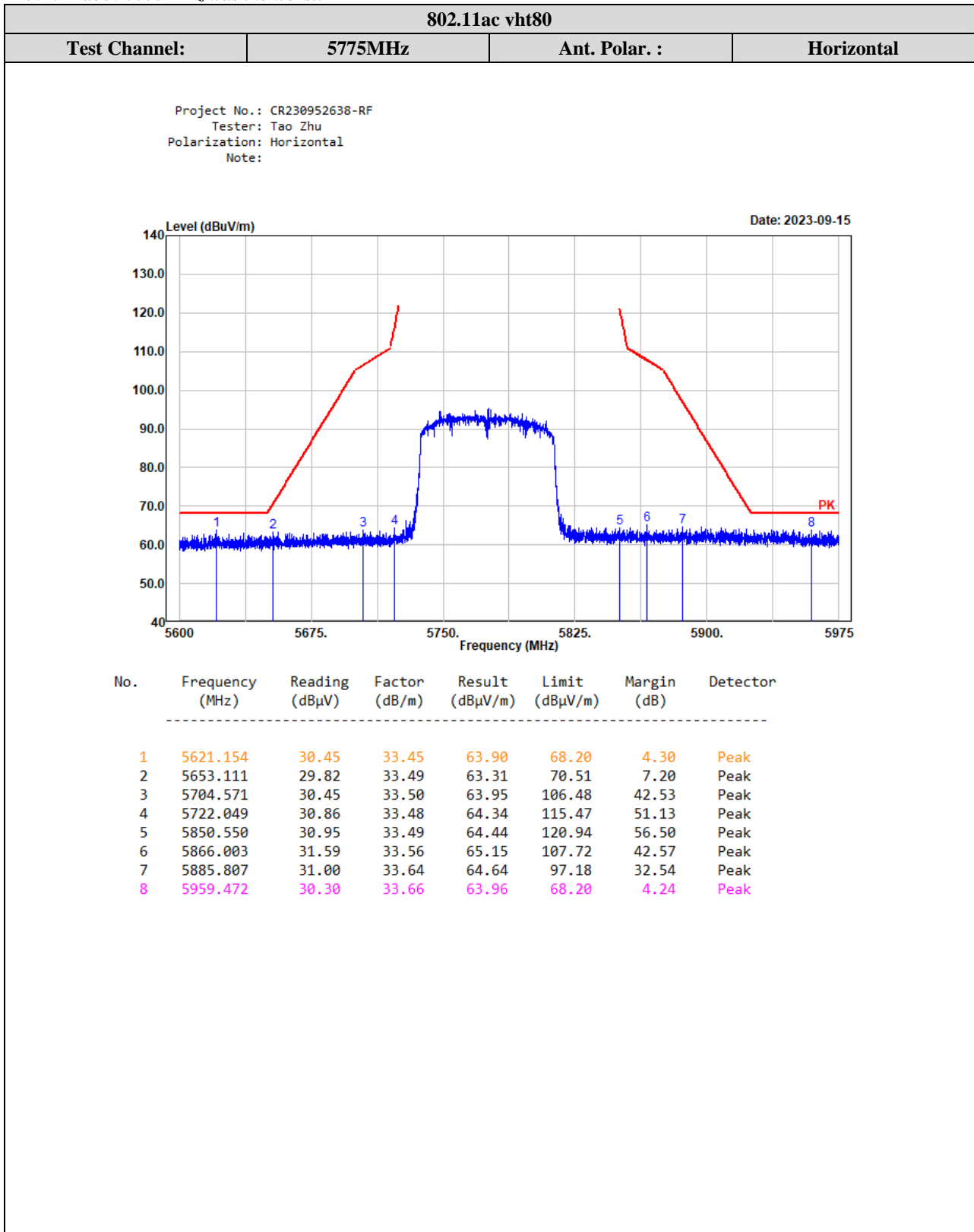



802.11ac vht80

Test Channel: 5775MHz Ant. Polar. : Vertical

Project No.: CR230952638-RF  
 Tester: Tao Zhu  
 Polarization: Vertical  
 Note:

Date: 2023-09-15

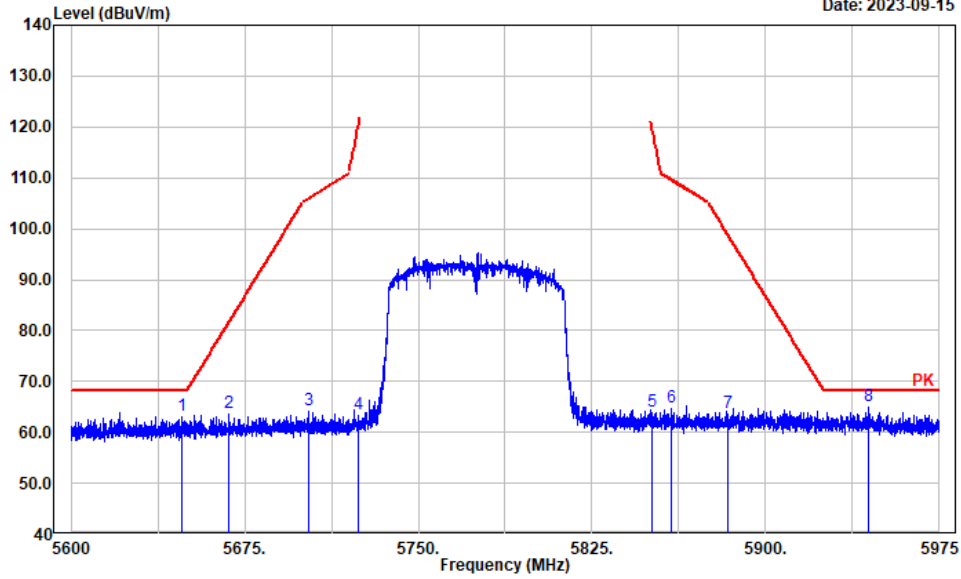

No.	Frequency (MHz)	Reading (dBμV)	Factor (dB/m)	Result (dBμV/m)	Limit (dBμV/m)	Margin (dB)	Detector
1	5647.935	29.97	33.47	63.44	68.20	4.76	Peak
2	5668.093	30.37	33.48	63.85	81.63	17.78	Peak
3	5702.621	30.82	33.49	64.31	105.94	41.63	Peak
4	5724.150	30.03	33.46	63.49	120.26	56.77	Peak
5	5851.150	30.77	33.47	64.24	119.58	55.34	Peak
6	5859.252	31.54	33.51	65.05	109.61	44.56	Peak
7	5883.932	30.13	33.62	63.75	98.57	34.82	Peak
8	5944.394	31.44	33.63	65.07	68.20	3.13	Peak

**Worst Test plots (802.11n ht20 5825 MHz was the worst)**

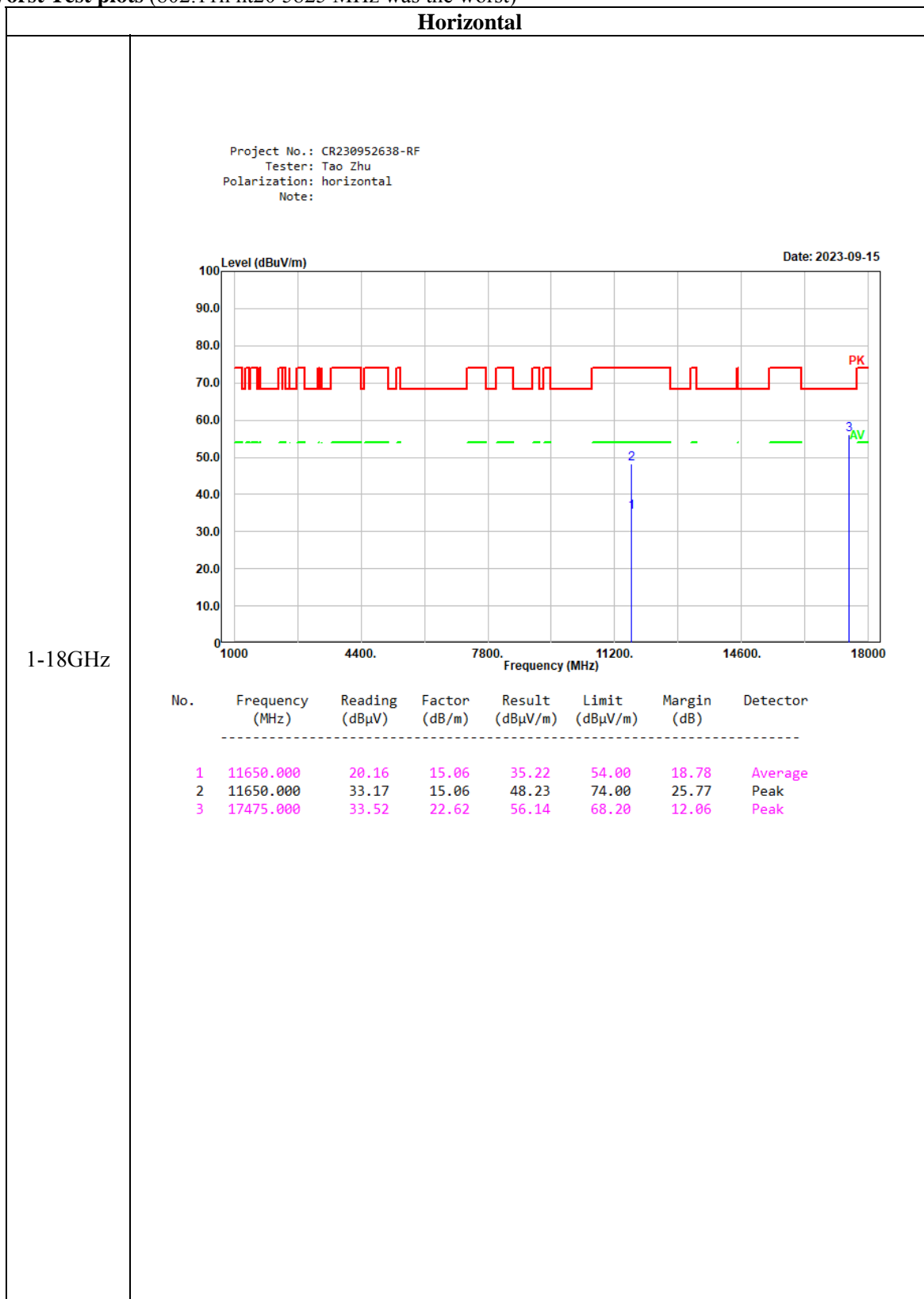

**Horizontal**

Project No.: CR230952638-RF  
 Tester: Tao Zhu  
 Polarization: Horizontal  
 Note:

Date: 2023-09-15

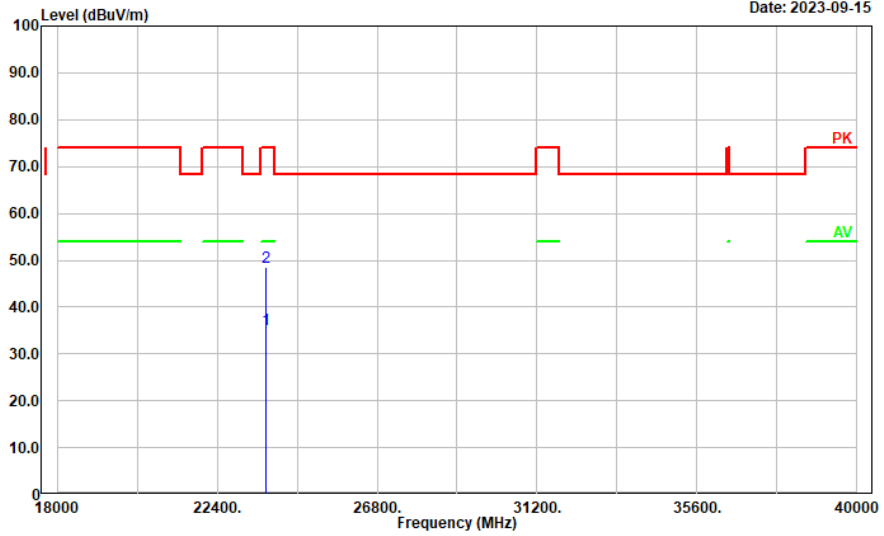

18-40GHz

No.	Frequency (MHz)	Reading (dBμV)	Factor (dB/m)	Result (dBμV/m)	Limit (dBμV/m)	Margin (dB)	Detector
1	23750.000	36.70	-1.44	35.26	54.00	18.74	Average
2	23750.000	49.98	-1.44	48.54	74.00	25.46	Peak

**Vertical**

Project No.: CR230952638-RF  
 Tester: Tao Zhu  
 Polarization: Vertical  
 Note:

Date: 2023-09-15

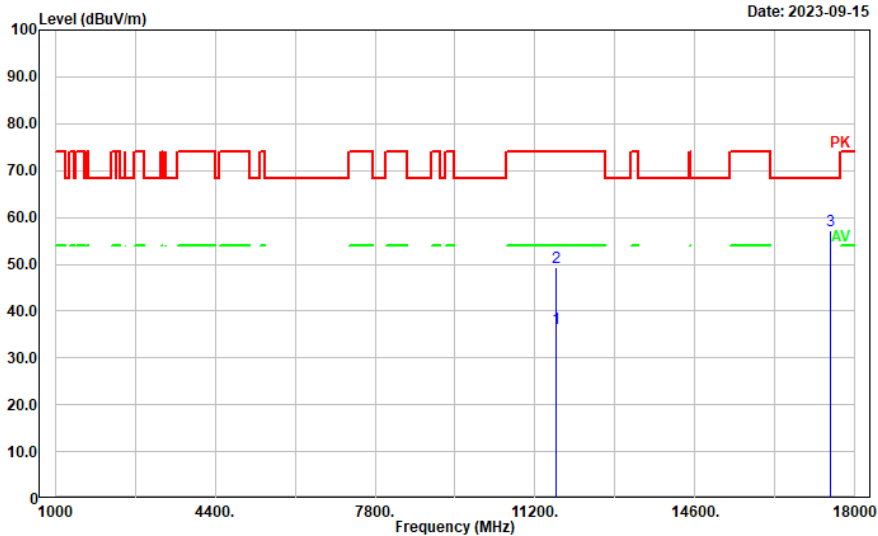

1-18GHz

No.	Frequency (MHz)	Reading (dBμV)	Factor (dB/m)	Result (dBμV/m)	Limit (dBμV/m)	Margin (dB)	Detector
1	11650.000	21.29	15.04	36.33	54.00	17.67	Average
2	11650.000	34.41	15.04	49.45	74.00	24.55	Peak
3	17475.000	34.58	22.60	57.18	68.20	11.02	Peak

**Vertical**

Project No.: CR230952638-RF  
 Tester: Tao Zhu  
 Polarization: Vertical  
 Note:

Date: 2023-09-15

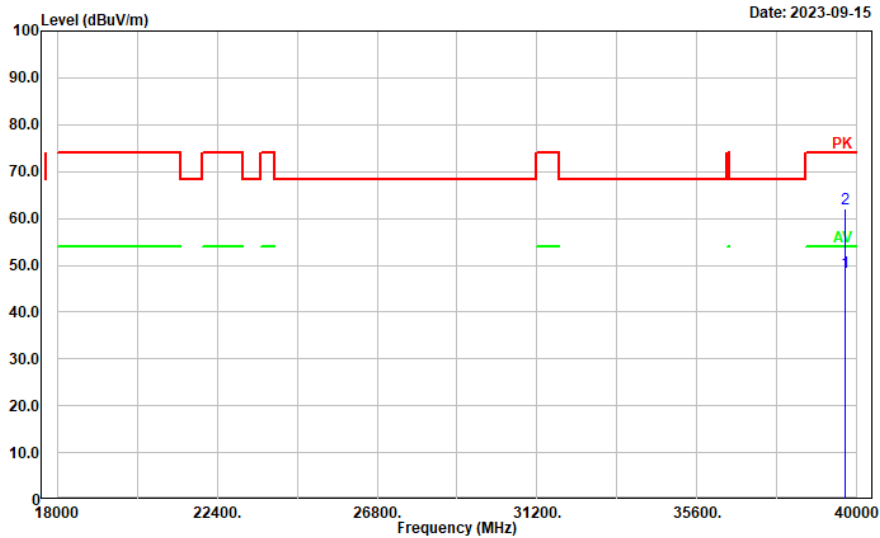

18-40GHz

No.	Frequency (MHz)	Reading (dB $\mu$ V)	Factor (dB/m)	Result (dB $\mu$ V/m)	Limit (dB $\mu$ V/m)	Margin (dB)	Detector
1	39674.340	39.16	9.46	48.62	54.00	5.38	Average
2	39674.340	52.48	9.46	61.94	74.00	12.06	Peak

**4.3 Emission Bandwidth:**

Serial Number:	2B1F-2	Test Date:	2023/9/13
Test Site:	RF	Test Mode:	Transmitting
Tester:	Arthur Su	Test Result:	Pass

**Environmental Conditions:**

Temperature: (°C)	25.9	Relative Humidity: (%)	60	ATM Pressure: (kPa)	100
----------------------	------	------------------------------	----	------------------------	-----

**Test Equipment List and Details:**

Manufacturer	Description	Model	Serial Number	Calibration Date	Calibration Due Date
R&S	Spectrum Analyzer	FSU26	200256	2023/3/31	2024/3/30
zhuoxiang	Coaxial Cable	SMA-178	211001	Each time	N/A
eastsheep	Coaxial Attenuator	2W-SMA-JK-18G	21060301	Each time	N/A

\* Statement of Traceability: China Certification ICT Co., Ltd (Dongguan) attests that all calibrations have been performed, traceable to National Primary Standards and International System of Units (SI).

**Test Data:**

Please refer to the below tables and plots.

**5150~5250MHz:**

Test Modes	Test Frequency (MHz)	26 dB Bandwidth (MHz)	99% Occupied Bandwidth (MHz)
802.11a	5180	21.28	16.48
	5200	20.48	16.48
	5240	21.84	16.48
802.11n ht20	5180	20.72	17.52
	5200	20.64	17.52
	5240	20.8	17.52
802.11n ht40	5190	40.8	36.16
	5230	41.28	36.16
802.11ac vht80	5210	83.2	75.2

**Note:**

The 99% Occupied Bandwidth have not fall into the band 5250-5350MHz, please refer to the test plots of 99% Occupied Bandwidth.

**5725~5850MHz:**

Test Modes	Test Frequency (MHz)	6 dB Bandwidth (MHz)	99% Occupied Bandwidth (MHz)
802.11a	5745	15.2	16.8
	5785	15.2	16.56
	5825	15.2	16.56
802.11n ht20	5745	15.2	17.6
	5785	15.44	17.6
	5825	15.2	17.52
802.11n ht40	5755	34.88	36.16
	5795	35.52	36.16
802.11ac vht80	5775	75.52	75.2

## Note:

1. 6dB Emission Bandwidth Limit:  $\geq 0.5$  MHz
2. the 99% Occupied Bandwidth have not fall into the band 5470-5725MHz, please refer to the test plots of 99% Occupied Bandwidth.

5150-5250MHz:

26dB Emission Bandwidth

<p>802.11a Lowest Channel</p>	<p>ProjectNo.:CR230952638-RF Tester:Arthur Su Date: 13.SEP.2023 21:49:20</p>
<p>802.11a Middle Channel</p>	<p>ProjectNo.:CR230952638-RF Tester:Arthur Su Date: 13.SEP.2023 21:52:08</p>
<p>802.11a Highest Channel</p>	<p>ProjectNo.:CR230952638-RF Tester:Arthur Su Date: 13.SEP.2023 21:54:47</p>



### 26dB Emission Bandwidth

802.11n ht20  
Lowest Channel

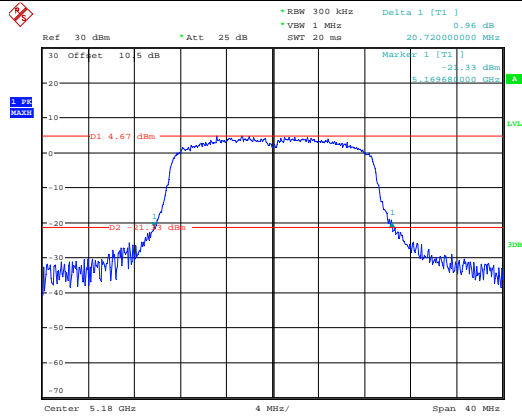

ProjectNo.:CR230952638-RF Tester:Arthur Su  
 Date: 13.SEP.2023 21:57:54

802.11n ht20  
Middle Channel

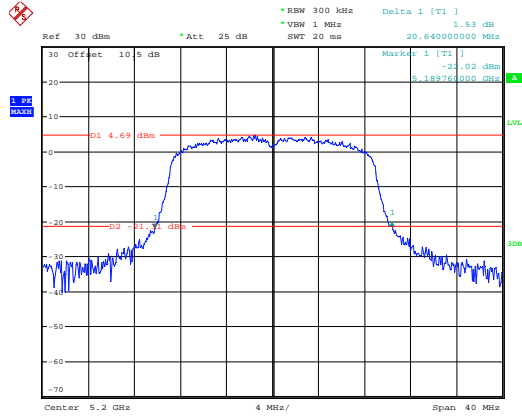

ProjectNo.:CR230952638-RF Tester:Arthur Su  
 Date: 13.SEP.2023 22:00:40

802.11n ht20  
Highest Channel

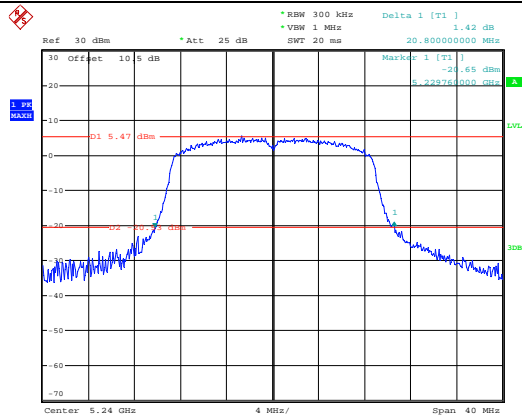

ProjectNo.:CR230952638-RF Tester:Arthur Su  
 Date: 13.SEP.2023 22:04:32

### 26dB Emission Bandwidth

802.11n ht40  
Lowest Channel

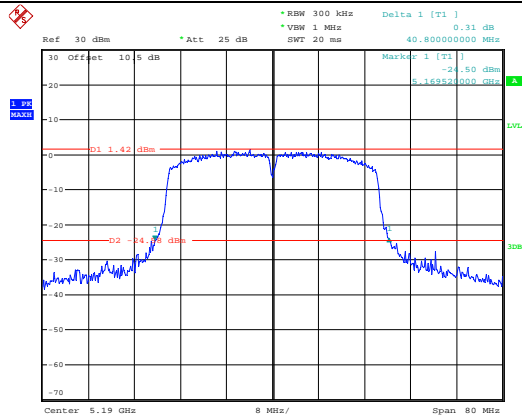

ProjectNo.:CR230952638-RF Tester:Arthur Su  
Date: 13.SEP.2023 22:06:49

802.11n ht40  
Highest Channel

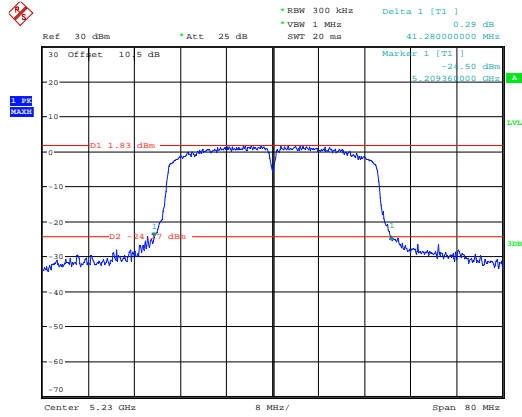

ProjectNo.:CR230952638-RF Tester:Arthur Su  
Date: 13.SEP.2023 22:08:34

802.11ac vht80  
Middle Channel

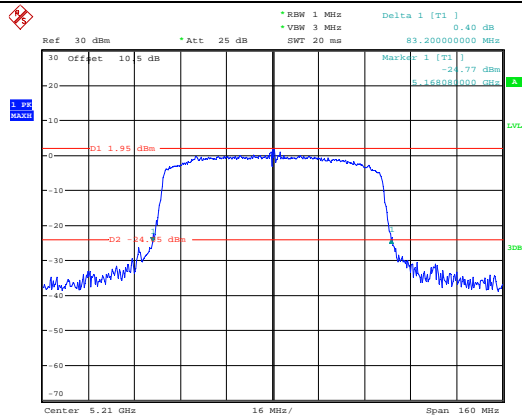

ProjectNo.:CR230952638-RF Tester:Arthur Su  
Date: 13.SEP.2023 22:32:16

**99% Emission Bandwidth**

<p>802.11a Lowest Channel</p>	<p>ProjectNo.:CR230952638-RF Tester:Arthur Su Date: 13.SEP.2023 21:49:40</p>
<p>802.11a Middle Channel</p>	<p>ProjectNo.:CR230952638-RF Tester:Arthur Su Date: 13.SEP.2023 21:52:27</p>
<p>802.11a Highest Channel</p>	<p>ProjectNo.:CR230952638-RF Tester:Arthur Su Date: 13.SEP.2023 21:55:07</p>

**99% Emission Bandwidth**

802.11n ht20  
Lowest Channel

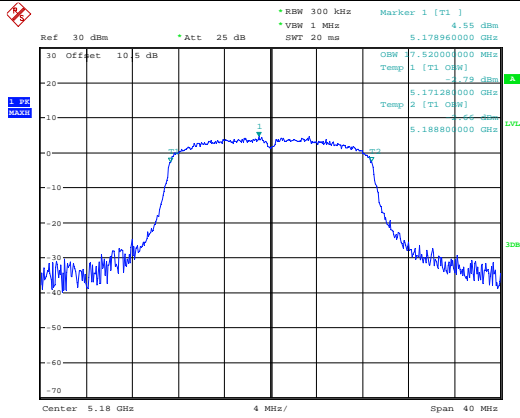

ProjectNo.:CR230952638-RF Tester:Arthur Su  
Date: 13.SEP.2023 21:58:15

802.11n ht20  
Middle Channel

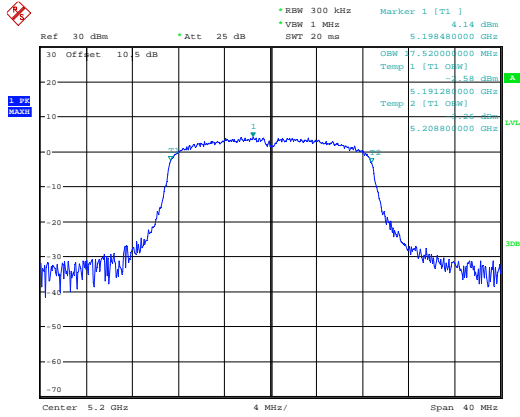

ProjectNo.:CR230952638-RF Tester:Arthur Su  
Date: 13.SEP.2023 22:01:28

802.11n ht20  
Highest Channel

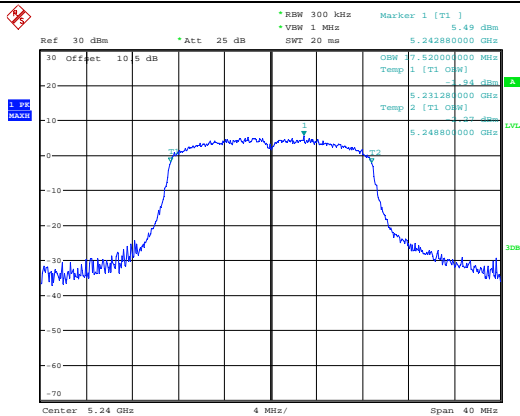

ProjectNo.:CR230952638-RF Tester:Arthur Su  
Date: 13.SEP.2023 22:04:52

**99% Emission Bandwidth**

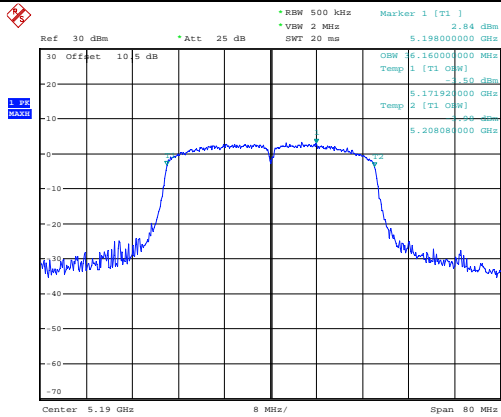
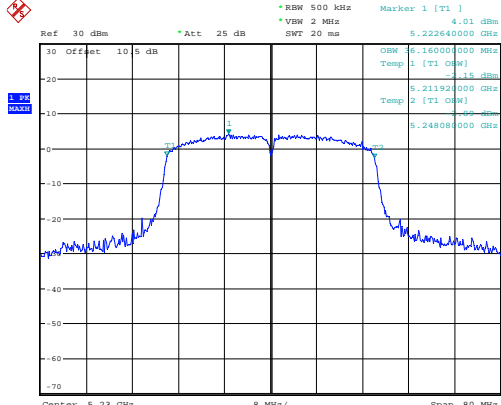
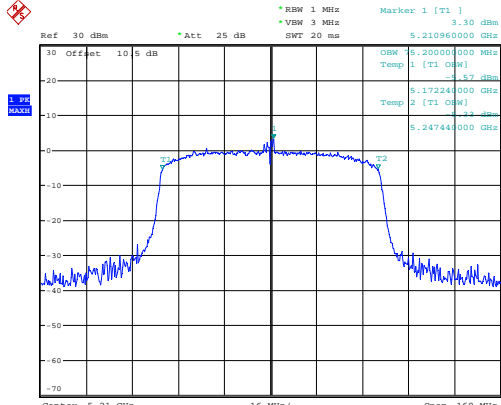
<p>802.11n ht40 Lowest Channel</p>	 <p>ProjectNo.:CR230952638-RF Tester:Arthur Su Date: 13.SEP.2023 22:07:05</p>
<p>802.11n ht40 Highest Channel</p>	 <p>ProjectNo.:CR230952638-RF Tester:Arthur Su Date: 13.SEP.2023 22:08:56</p>
<p>802.11ac vht80 Middle Channel</p>	 <p>ProjectNo.:CR230952638-RF Tester:Arthur Su Date: 13.SEP.2023 22:32:41</p>

5725-5850MHz:

6dB Emission Bandwidth	
<p>802.11a Lowest Channel</p>	<p>ProjectNo.:CR230952638-RF Tester:Arthur Su Date: 13.SEP.2023 22:38:12</p>
<p>802.11a Middle Channel</p>	<p>ProjectNo.:CR230952638-RF Tester:Arthur Su Date: 13.SEP.2023 22:40:42</p>
<p>802.11a Highest Channel</p>	<p>ProjectNo.:CR230952638-RF Tester:Arthur Su Date: 13.SEP.2023 22:42:35</p>

<b>6dB Emission Bandwidth</b>	
<p>802.11n ht20 Lowest Channel</p>	<p>ProjectNo.:CR230952638-RF Tester:Arthur Su Date: 13.SEP.2023 22:45:18</p>
<p>802.11n ht20 Middle Channel</p>	<p>ProjectNo.:CR230952638-RF Tester:Arthur Su Date: 13.SEP.2023 22:47:22</p>
<p>802.11n ht20 Highest Channel</p>	<p>ProjectNo.:CR230952638-RF Tester:Arthur Su Date: 13.SEP.2023 22:50:27</p>

<b>6dB Emission Bandwidth</b>	
802.11n ht40 Lowest Channel	<p>ProjectNo.:CR230952638-RF Tester:Arthur Su Date: 13.SEP.2023 22:53:39</p>
802.11n ht40 Highest Channel	<p>ProjectNo.:CR230952638-RF Tester:Arthur Su Date: 13.SEP.2023 22:55:28</p>
802.11ac vht80 Middle Channel	<p>ProjectNo.:CR230952638-RF Tester:Arthur Su Date: 13.SEP.2023 22:58:04</p>



**99% Emission Bandwidth**

<p>802.11a Lowest Channel</p>	<p>ProjectNo.:CR230952638-RF Tester:Arthur Su Date: 13.SEP.2023 22:38:36</p>
<p>802.11a Middle Channel</p>	<p>ProjectNo.:CR230952638-RF Tester:Arthur Su Date: 13.SEP.2023 22:41:01</p>
<p>802.11a Highest Channel</p>	<p>ProjectNo.:CR230952638-RF Tester:Arthur Su Date: 13.SEP.2023 22:42:53</p>

**99% Emission Bandwidth**

<p>802.11n ht20 Lowest Channel</p>	<p>ProjectNo.:CR230952638-RF Tester:Arthur Su Date: 13.SEP.2023 22:45:38</p>
<p>802.11n ht20 Middle Channel</p>	<p>ProjectNo.:CR230952638-RF Tester:Arthur Su Date: 13.SEP.2023 22:47:41</p>
<p>802.11n ht20 Highest Channel</p>	<p>ProjectNo.:CR230952638-RF Tester:Arthur Su Date: 13.SEP.2023 22:50:45</p>

**99% Emission Bandwidth**

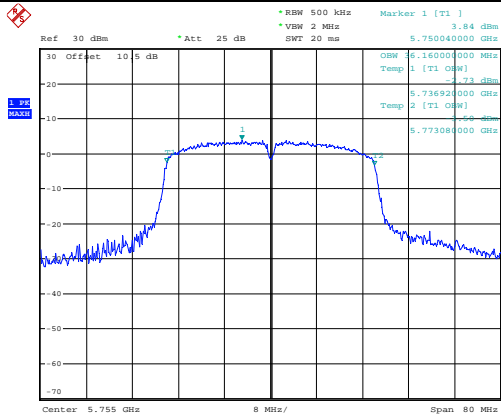
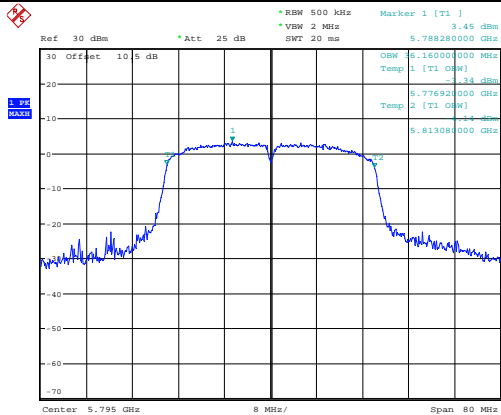
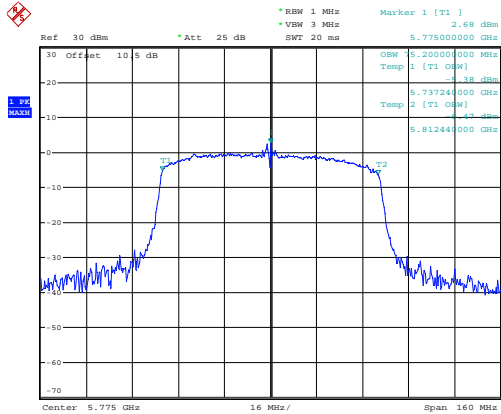
<p>802.11n ht40 Lowest Channel</p>	 <p>ProjectNo.:CR230952638-RF Tester:Arthur Su Date: 13.SEP.2023 22:54:01</p>
<p>802.11n ht40 Highest Channel</p>	 <p>ProjectNo.:CR230952638-RF Tester:Arthur Su Date: 13.SEP.2023 22:55:47</p>
<p>802.11ac vht80 Middle Channel</p>	 <p>ProjectNo.:CR230952638-RF Tester:Arthur Su Date: 13.SEP.2023 22:58:25</p>

**4.4 Maximum Conducted Output Power:**

Serial Number:	2B1F-2	Test Date:	2023/9/13
Test Site:	RF	Test Mode:	Transmitting
Tester:	Arthur Su	Test Result:	Pass

**Environmental Conditions:**

Temperature: (°C)	25.9	Relative Humidity: (%)	60	ATM Pressure: (kPa)	100
----------------------	------	---------------------------	----	------------------------	-----

**Test Equipment List and Details:**

Manufacturer	Description	Model	Serial Number	Calibration Date	Calibration Due Date
zhuoxiang	Coaxial Cable	SMA-178	211001	Each time	N/A
eastsheep	Coaxial Attenuator	2W-SMA-JK-18G	21060301	Each time	N/A
Anritsu	Power Meter	ML2495A	1106009	2023/8/4	2024/8/3
Anritsu	Pulse Power Sensor	MA2411A	10780	2023/8/4	2024/8/3

\* Statement of Traceability: China Certification ICT Co., Ltd (Dongguan) attests that all calibrations have been performed, traceable to National Primary Standards and International System of Units (SI).

**Test Data:**

5150-5250 MHz:

Test Modes	Test Frequency (MHz)	Max. Conducted Average Output Power(dBm)	
		Result	Limit
802.11a	5180	12.67	24
	5200	12.45	24
	5240	13.34	24
802.11n ht20	5180	11.78	24
	5200	11.5	24
	5240	12.46	24
802.11n ht40	5190	11.57	24
	5230	12.67	24
802.11ac vht80	5210	7.89	24

Note: The device is a client device.

5725-5850 MHz:

Test Modes	Test Frequency (MHz)	Max. Conducted Average Output Power(dBm)	
		Result	Limit
802.11a	5745	13.55	30
	5785	12.85	30
	5825	12.41	30
802.11n ht20	5745	12.52	30
	5785	12.01	30
	5825	11.46	30
802.11n ht40	5755	12.27	30
	5795	11.83	30
802.11ac vht80	5775	7.51	30

**4.5 Maximum power spectral density:**

Serial Number:	2B1F-2	Test Date:	2023/9/13
Test Site:	RF	Test Mode:	Transmitting
Tester:	Arthur Su	Test Result:	Pass

**Environmental Conditions:**

Temperature: (°C)	25.9	Relative Humidity: (%)	60	ATM Pressure: (kPa)	100
----------------------	------	---------------------------	----	------------------------	-----

**Test Equipment List and Details:**

Manufacturer	Description	Model	Serial Number	Calibration Date	Calibration Due Date
R&S	Spectrum Analyzer	FSU26	200256	2023/3/31	2024/3/30
zhuoxiang	Coaxial Cable	SMA-178	211001	Each time	N/A
eastsheep	Coaxial Attenuator	2W-SMA-JK-18G	21060301	Each time	N/A

\* Statement of Traceability: China Certification ICT Co., Ltd (Dongguan) attests that all calibrations have been performed, traceable to National Primary Standards and International System of Units (SI).

**Test Data:**

Please refer to the below tables and plots.

**5150~5250MHz:**

Test Modes	Test Frequency (MHz)	Reading (dBm/MHz)	Duty Cycle Factor (dB)	Maximum Power Spectral Density (dBm/MHz)	
				Result	Limit
802.11a	5180	2.01	0.13	2.14	11
	5200	1.75	0.13	1.88	11
	5240	2.58	0.13	2.71	11
802.11n ht20	5180	0.81	0.17	0.98	11
	5200	0.51	0.17	0.68	11
	5240	1.52	0.17	1.69	11
802.11n ht40	5190	-2.68	0.37	-2.31	11
	5230	-1.74	0.37	-1.37	11
802.11ac vht80	5210	-9.94	0.75	-9.19	11

**Note:**

- The device is a client device.
- For PSD test, duty cycle <98%, and duty cycle variations are less than ±2%, KDB 789033 D02 General UNII Test Procedures New Rules v02r01 Method SA-2 should be applied.
- For Duty cycle<98%, and duty cycle be considered to be constant (variations are less than ±2%), the duty cycle factor was added into the result.

**5725-5850 MHz:**

Test Modes	Test Frequency (MHz)	Reading (dBm/500kHz)	Duty Cycle Factor(dB)	Maximum Power Spectral Density (dBm/500kHz)	
				Result	Limit
802.11a	5745	-0.37	0.13	-0.24	30
	5785	-0.86	0.13	-0.73	30
	5825	-1.31	0.13	-1.18	30
802.11n ht20	5745	-1.34	0.17	-1.17	30
	5785	-2.02	0.17	-1.85	30
	5825	-2.54	0.17	-2.37	30
802.11n ht40	5755	-5.14	0.37	-4.77	30
	5795	-5.45	0.37	-5.08	30
802.11ac vht80	5775	-13.11	0.75	-12.36	30

## Note:

1. For PSD test, duty cycle <98%, and duty cycle variations are less than  $\pm 2\%$ , KDB 789033 D02 General UNII Test Procedures New Rules v02r01 Method SA-2 should be applied.
2. For Duty cycle<98%, and Duty cycle be considered to be constant (variations are less than  $\pm 2\%$ ), the duty cycle factor was added into the result.

5150-5250MHz:

Maximum power spectral density

<p>802.11a Lowest Channel</p>	<p>ProjectNo.:CR230952638-RF Tester:Arthur Su Date: 13.SEP.2023 21:51:11</p>
<p>802.11a Middle Channel</p>	<p>ProjectNo.:CR230952638-RF Tester:Arthur Su Date: 13.SEP.2023 21:53:47</p>
<p>802.11a Highest Channel</p>	<p>ProjectNo.:CR230952638-RF Tester:Arthur Su Date: 13.SEP.2023 21:56:00</p>



**Maximum power spectral density**

802.11n ht20  
Lowest Channel

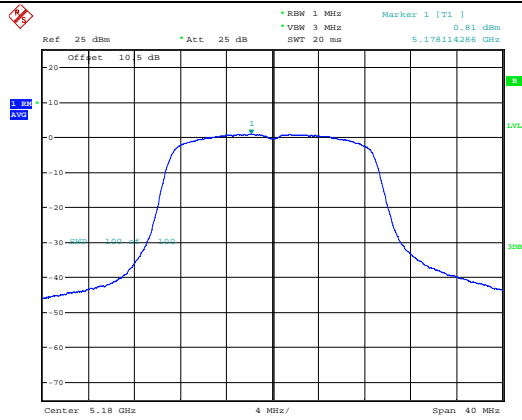

ProjectNo.:CR230952638-RF Tester:Arthur Su  
Date: 13.SEP.2023 22:00:02

802.11n ht20  
Middle Channel

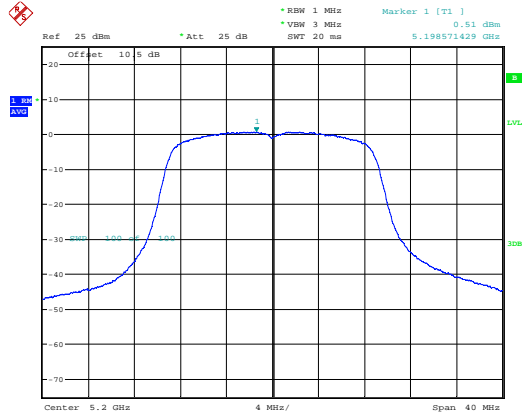

ProjectNo.:CR230952638-RF Tester:Arthur Su  
Date: 13.SEP.2023 22:03:16

802.11n ht20  
Highest Channel

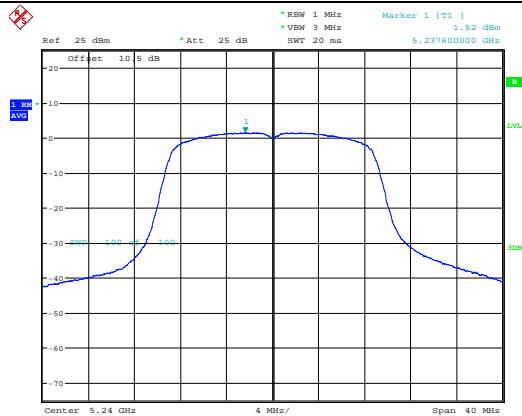

ProjectNo.:CR230952638-RF Tester:Arthur Su  
Date: 13.SEP.2023 22:05:49

**Maximum power spectral density**

802.11n ht40  
Lowest Channel

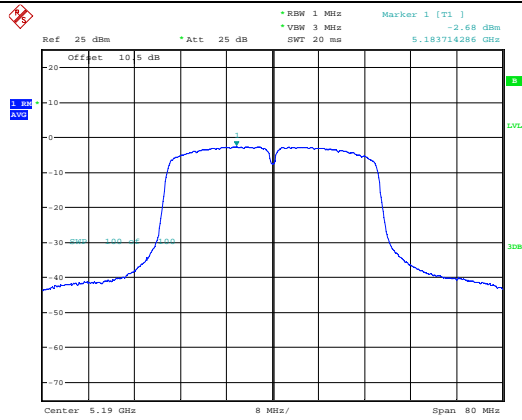

ProjectNo.:CR230952638-RF    Tester:Arthur Su  
Date: 13.SEP.2023    22:07:54

802.11n ht40  
Highest Channel

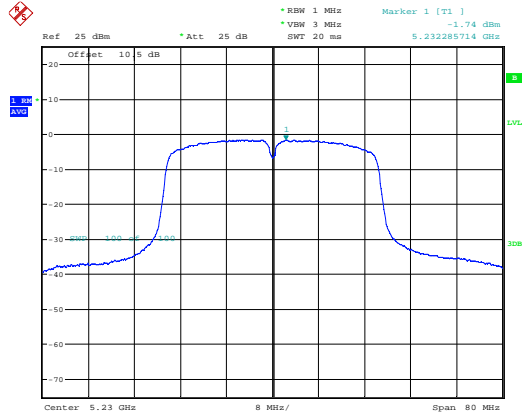

ProjectNo.:CR230952638-RF    Tester:Arthur Su  
Date: 13.SEP.2023    22:13:53

802.11ac vht80  
Middle Channel

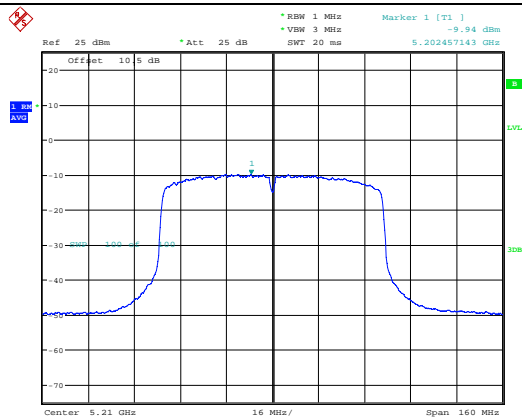

ProjectNo.:CR230952638-RF    Tester:Arthur Su  
Date: 13.SEP.2023    22:34:53

5725-5850MHz

Maximum power spectral density

802.11a  
Lowest Channel

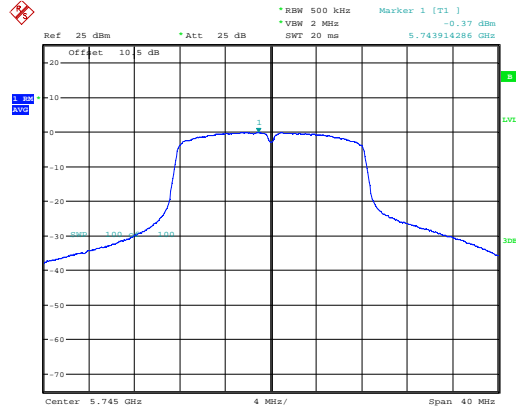

ProjectNo.:CR230952638-RP Tester:Arthur Su  
Date: 13.SEP.2023 22:39:58

802.11a  
Middle Channel

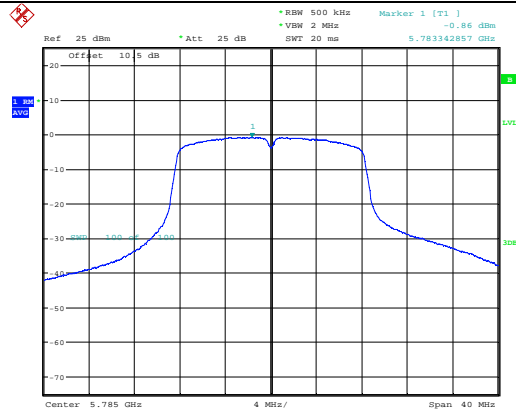

ProjectNo.:CR230952638-RP Tester:Arthur Su  
Date: 13.SEP.2023 22:41:52

802.11a  
Highest Channel

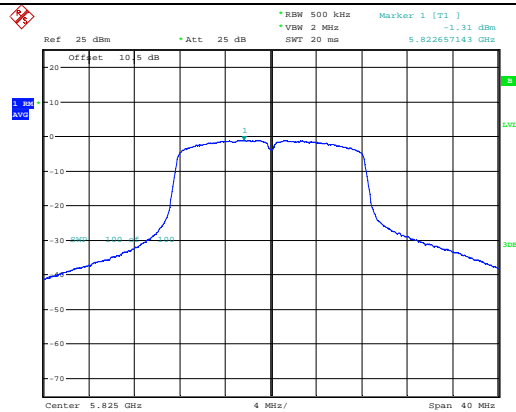

ProjectNo.:CR230952638-RP Tester:Arthur Su  
Date: 13.SEP.2023 22:44:02

### Maximum power spectral density

802.11n ht20  
Lowest Channel

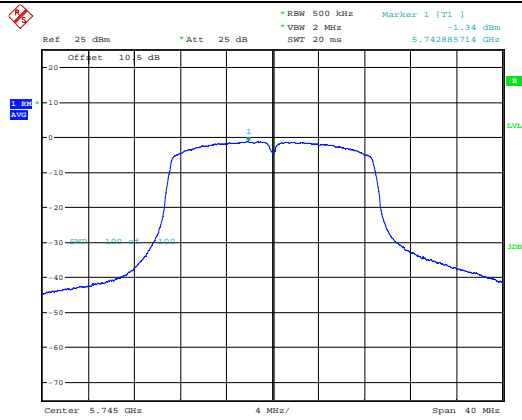

ProjectNo.:CR230952638-RF Tester:Arthur Su  
Date: 13.SEP.2023 22:46:38

802.11n ht20  
Middle Channel

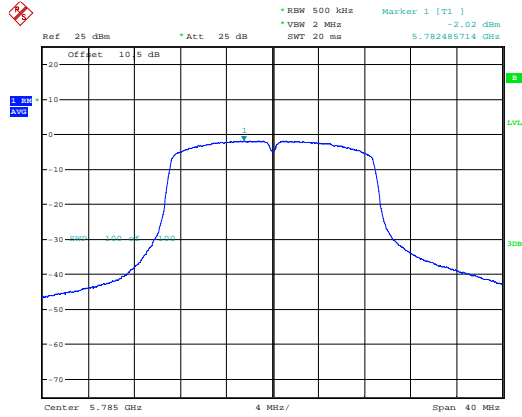

ProjectNo.:CR230952638-RF Tester:Arthur Su  
Date: 13.SEP.2023 22:49:14

802.11n ht20  
Highest Channel

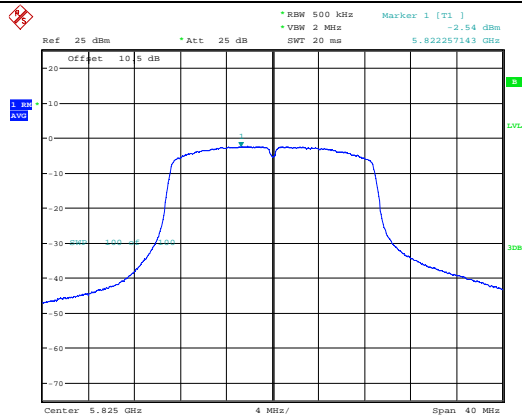

ProjectNo.:CR230952638-RF Tester:Arthur Su  
Date: 13.SEP.2023 22:51:35

**Maximum power spectral density**

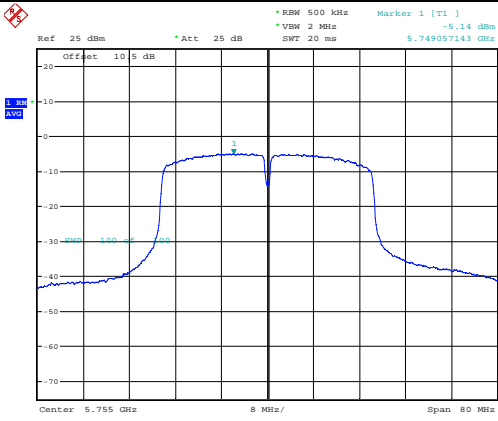
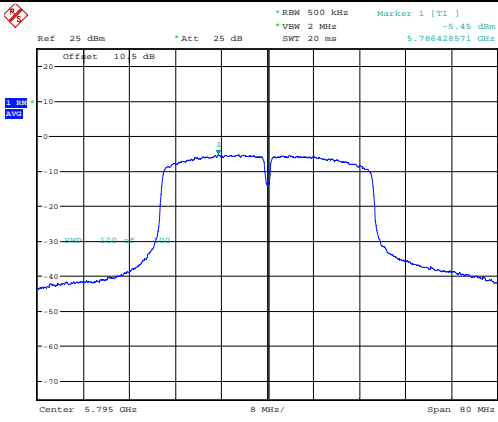
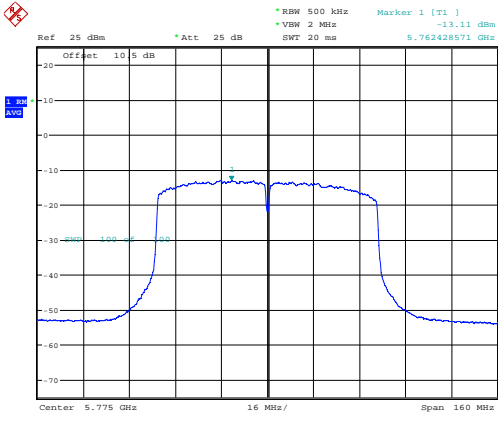
<p>802.11n ht40 Lowest Channel</p>	 <p>ProjectNo.:CR230952638-RF Tester:Arthur Su Date: 13.SEP.2023 22:54:52</p>
<p>802.11n ht40 Highest Channel</p>	 <p>ProjectNo.:CR230952638-RF Tester:Arthur Su Date: 13.SEP.2023 22:56:34</p>
<p>802.11ac vht80 Middle Channel</p>	 <p>ProjectNo.:CR230952638-RF Tester:Arthur Su Date: 13.SEP.2023 23:00:27</p>

**4.6 Duty Cycle:**

Serial Number:	2B1F-2	Test Date:	2023/9/13
Test Site:	RF	Test Mode:	Transmitting
Tester:	Arthur Su	Test Result:	N/A

**Environmental Conditions:**

Temperature: (°C)	25.9	Relative Humidity: (%)	60	ATM Pressure: (kPa)	100
----------------------	------	---------------------------	----	------------------------	-----

**Test Equipment List and Details:**

Manufacturer	Description	Model	Serial Number	Calibration Date	Calibration Due Date
R&S	Spectrum Analyzer	FSU26	200256	2023/3/31	2024/3/30
zhuoxiang	Coaxial Cable	SMA-178	211001	Each time	N/A
eastsheep	Coaxial Attenuator	2W-SMA-JK-18G	21060301	Each time	N/A

\* Statement of Traceability: China Certification ICT Co., Ltd (Dongguan) attests that all calibrations have been performed, traceable to National Primary Standards and International System of Units (SI).

**Test Data:**

Test Modes	Ton (ms)	Ton+off (ms)	Duty cycle (%)	1/T (Hz)	Duty Cycle Factor (dB)	VBW Setting (kHz)
802.11a	2.063	2.127	96.99	485	0.13	1
802.11n ht20	1.922	1.999	96.15	520	0.17	1
802.11n ht40	0.944	1.029	91.74	1059	0.37	2
802.11ac vht80	0.47	0.558	84.23	2128	0.75	3

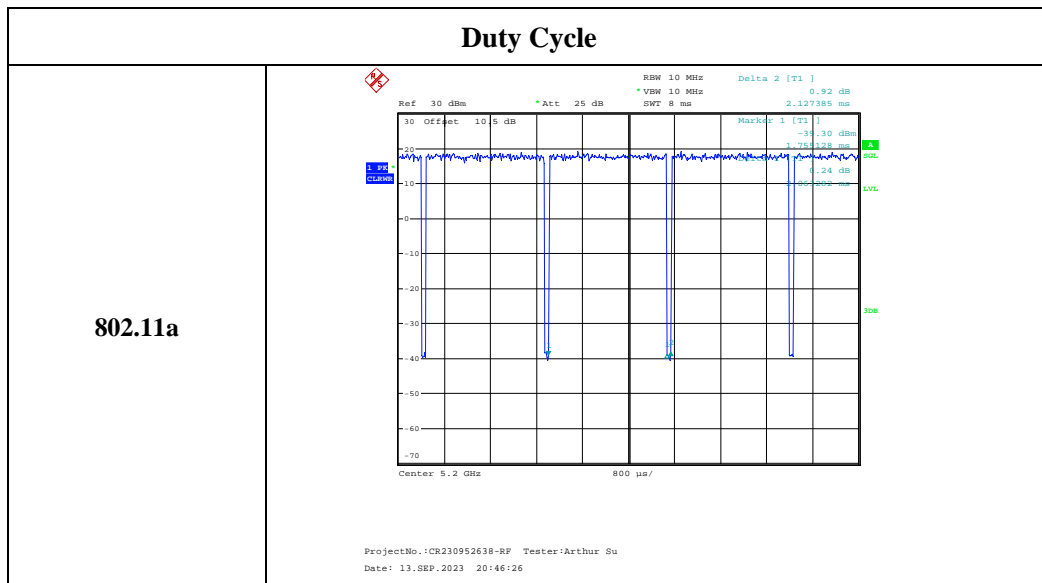

### Duty Cycle

802.11n ht20

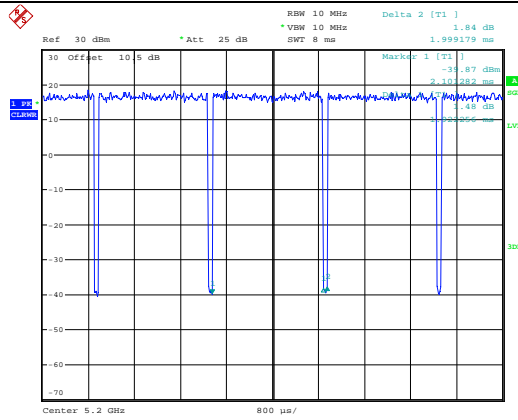

ProjectNo.:CR230952638-RF Tester:Arthur Su  
Date: 13.SEP.2023 20:48:18

802.11n ht40

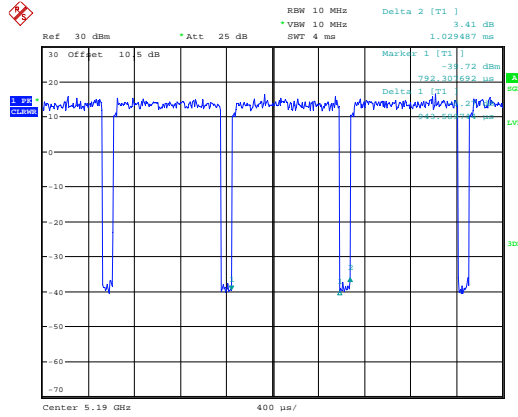

ProjectNo.:CR230952638-RF Tester:Arthur Su  
Date: 13.SEP.2023 20:50:03

802.11ac vht80

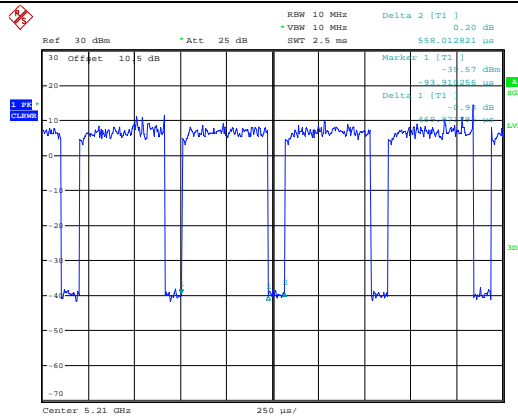

ProjectNo.:CR230952638-RF Tester:Arthur Su  
Date: 13.SEP.2023 20:52:00

## **5. EUT PHOTOGRAPHS**

---

Please refer to the attachment CR230952638-EXP EUT EXTERNAL PHOTOGRAPHS and CR230952638-INP EUT INTERNAL PHOTOGRAPHS



## **6. TEST SETUP PHOTOGRAPHS**

---

Please refer to the attachment CR230952638-00E-TSP TEST SETUP PHOTOGRAPHS.

**===== END OF REPORT =====**