



**中认信通**  
CHINA CERTIFICATION ICT CO., LTD (DONGGUAN)



## TEST REPORT

**Applicant:** CHITECH SHENZHEN TECHNOLOGY CO.,LTD

Address: 101,NO.48,Xiashijia Road,Gongming Town,Guangming  
Dist.,Shenzhen,China

**FCC ID:** 2AXUI-W120

**Product Name:** Tablet PC

**Standard(s):** 47 CFR Part 15, Subpart C(15.247)  
ANSI C63.10-2013  
KDB 558074 D01 15.247 Meas Guidance v05r02

The above device has been tested and found compliant with the requirement of the relative standards by China Certification ICT Co., Ltd (Dongguan)

**Report Number:** CR230952638-00C

**Date Of Issue:** 2023/9/21

**Reviewed By:** Calvin Chen

Title: RF Engineer

**Approved By:** Sun Zhong

Title: Manager

**Test Laboratory:** China Certification ICT Co., Ltd (Dongguan)

No. 113, Pingkang Road, Dalang Town, Dongguan,  
Guangdong, China  
Tel: +86-769-82016888

*Calvin Chen*

*Sun Zhong*

## Test Facility

The Test site used by China Certification ICT Co., Ltd (Dongguan) to collect test data is located on the No. 113, Pingkang Road, Dalang Town, Dongguan, Guangdong, China.

The lab has been recognized as the FCC accredited lab under the KDB 974614 D01 and is listed in the FCC Public Access Link (PAL) database, FCC Registration No.: 442868, the FCC Designation No.: CN1314.

The lab has been recognized by Innovation, Science and Economic Development Canada to test to Canadian radio equipment requirements, the CAB identifier: CN0123.

## Declarations

China Certification ICT Co., Ltd (Dongguan) is not responsible for the authenticity of any test data provided by the applicant. Data included from the applicant that may affect test results are marked with a triangle symbol “▲”. Customer model name, addresses, names, trademarks etc. are not considered data.

Unless otherwise stated the results shown in this test report refer only to the sample(s) tested.

This report cannot be reproduced except in full, without prior written approval of the Company.

This report is valid only with a valid digital signature. The digital signature may be available only under the Adobe software above version 7.0.

This report may contain data that are not covered by the accreditation scope and shall be marked with an asterisk “★”.

## CONTENTS

<b>DOCUMENT REVISION HISTORY .....</b>	<b>5</b>
<b>1. GENERAL INFORMATION .....</b>	<b>6</b>
<b>1.1 PRODUCT DESCRIPTION FOR EQUIPMENT UNDER TEST (EUT) .....</b>	<b>6</b>
<b>1.2 DESCRIPTION OF TEST CONFIGURATION.....</b>	<b>9</b>
1.2.1 EUT Operation Condition:.....	9
1.2.2 Support Equipment List and Details .....	9
1.2.3 Support Cable List and Details .....	9
1.2.4 Block Diagram of Test Setup.....	10
<b>1.3 MEASUREMENT UNCERTAINTY .....</b>	<b>11</b>
<b>2. SUMMARY OF TEST RESULTS .....</b>	<b>12</b>
<b>3. REQUIREMENTS AND TEST PROCEDURES .....</b>	<b>13</b>
<b>3.1 AC LINE CONDUCTED EMISSIONS.....</b>	<b>13</b>
3.1.1 Applicable Standard.....	13
3.1.2 EUT Setup.....	14
3.1.3 EMI Test Receiver Setup .....	14
3.1.4 Test Procedure .....	15
3.1.5 Corrected Amplitude & Margin Calculation.....	15
<b>3.2 RADIATION SPURIOUS EMISSIONS.....</b>	<b>16</b>
3.2.1 Applicable Standard.....	16
3.2.2 EUT Setup.....	16
3.2.3 EMI Test Receiver & Spectrum Analyzer Setup .....	17
3.2.4 Test Procedure .....	17
3.2.5 Corrected Amplitude & Margin Calculation.....	17
<b>3.3 MINIMUM 6 DB EMISSION BANDWIDTH .....</b>	<b>18</b>
3.3.1 Applicable Standard.....	18
3.3.2 EUT Setup.....	18
3.3.3 Test Procedure .....	18
<b>3.4 99% OCCUPIED BANDWIDTH.....</b>	<b>19</b>
3.4.1 EUT Setup.....	19
3.4.2 Test Procedure .....	19
<b>3.5 MAXIMUM CONDUCTED OUTPUT POWER.....</b>	<b>20</b>
3.5.1 Applicable Standard.....	20
3.5.2 EUT Setup.....	20
3.5.3 Test Procedure .....	20
<b>3.6 MAXIMUM POWER SPECTRAL DENSITY .....</b>	<b>21</b>
3.6.1 Applicable Standard.....	21
3.6.2 EUT Setup.....	21
3.6.3 Test Procedure .....	21
<b>3.7 100 KHZ BANDWIDTH OF FREQUENCY BAND EDGE.....</b>	<b>22</b>
3.7.1 Applicable Standard.....	22
3.7.2 EUT Setup.....	22
3.7.3 Test Procedure .....	22

**3.8 DUTY CYCLE ..... 23**  
    3.8.1 EUT Setup..... 23  
    3.8.2 Test Procedure ..... 23  
**3.9 ANTENNA REQUIREMENT..... 23**  
    3.9.1 Applicable Standard..... 23  
    3.9.2 Judgment..... 23  
**4. Test DATA AND RESULTS ..... 24**  
    **4.1 AC LINE CONDUCTED EMISSIONS..... 24**  
    **4.2 RADIATION SPURIOUS EMISSIONS ..... 27**  
    **4.3 MINIMUM 6 DB EMISSION BANDWIDTH ..... 39**  
    **4.4 99% OCCUPIED BANDWIDTH..... 44**  
    **4.5 MAXIMUM CONDUCTED OUTPUT POWER..... 49**  
    **4.6 MAXIMUM POWER SPECTRAL DENSITY ..... 50**  
    **4.7 100 KHZ BANDWIDTH OF FREQUENCY BAND EDGE: ..... 55**  
    **4.8 DUTY CYCLE:..... 60**  
**5. EUT PHOTOGRAPHS ..... 62**  
**6. TEST SETUP PHOTOGRAPHS ..... 63**

## DOCUMENT REVISION HISTORY

Revision Number	Report Number	Description of Revision	Date of Revision
1.0	CR230952638-00C	Original Report	2023/9/21

## 1. GENERAL INFORMATION

### 1.1 Product Description for Equipment under Test (EUT)

<b>EUT Name:</b>	Tablet PC
<b>EUT Model:</b>	W120
<b>Multiple Models:</b>	F39WQ, F39W, W310, W320, W510, W520
<b>Trade Name:</b>	TIBUTA
<b>Operation Frequency:</b>	2412-2462MHz (802.11b/g/n ht20), 2422-2452MHz (802.11n ht40)
<b>Maximum Peak Output Power (Conducted):</b>	17.81 dBm (802.11b/g/n)
<b>Modulation Type:</b>	802.11b: DSSS-DBPSK, DQPSK, CCK 802.11g/n: OFDM-BPSK, QPSK, 16QAM, 64QAM
<b>Rated Input Voltage:</b>	DC 12V from adapter or DC 7.6V from battery
<b>Serial Number:</b>	2B1F-1 (for Emissions Test) 2B1F-2 (for RF Conducted Test)
<b>EUT Received Date:</b>	2023/9/8
<b>EUT Received Status:</b>	Good
Note: The Multiple models are electrically identical with the test model. Please refer to the declaration letter for more detail, which was provided by manufacturer.	

#### Operation Frequency Detail: For 802.11b/g/n ht20:

Channel	Frequency (MHz)	Channel	Frequency (MHz)
1	2412	7	2442
2	2417	8	2447
3	2422	9	2452
4	2427	10	2457
5	2432	11	2462
6	2437	/	/
Per section 15.31(m), the below frequencies were performed the test as below:			
Test Channel		Frequency (MHz)	
Lowest		2412	
Middle		2437	
Highest		2462	

#### For 802.11n ht40:

Channel	Frequency (MHz)	Channel	Frequency (MHz)
3	2422	7	2442
4	2427	8	2447
5	2432	9	2452
6	2437	/	/
Per section 15.31(m), the below frequencies were performed the test as below:			
Test Channel		Frequency (MHz)	
Lowest		2422	
Middle		2437	

Highest	2452
---------	------

**Antenna Information Detail▲:**

Antenna Type	input impedance (Ohm)	Frequency Range	Antenna Gain
FPC	50	2.4~2.5GHz	1.73 dBi
		5.0~5.85GHz	1.65 dBi

The Method of §15.203 Compliance:

- Antenna was permanently attached to the unit.  
 Antenna use a unique type of connector to attach to the EUT.  
 Unit was professionally installed, and installer shall be responsible for verifying that the correct antenna is employed with the unit.

**Accessory Information:**

Accessory Description	Manufacturer	Model	Parameters
Adapter	Shenzhen Sunshine Technological Co.td	XSG-1203000HUS	Input: 100-240V~50/60Hz 0.8A Output: 12V = 3A
keyboard	CHITECH	Unknown	Unknown



## 1.2 Description of Test Configuration

### 1.2.1 EUT Operation Condition:

#### For 802.11b/g/n:

<b>EUT Operation Mode:</b>	The system was configured for testing in Engineering Mode, which was provided by the manufacturer.
<b>Equipment Modifications:</b>	No
<b>EUT Exercise Software:</b>	QRCT.exe

The software was provided by manufacturer. The maximum power was configured as below, that was provided by the manufacturer ▲:

Test Modes	Data Rate	Power Level Setting		
		Lowest Channel	Middle Channel	Highest Channel
802.11b	1Mbps	16	16	16
802.11g	6Mbps	14	14	14
802.11n ht20	MCS0	14	14	14
802.11n ht40	MCS0	14	14	14

The above are the worst-case data rates, which are determined for each mode based upon investigations by measuring the average power and PSD across all data rates, bandwidths, and modulations.

### 1.2.2 Support Equipment List and Details

Manufacturer	Description	Model	Serial Number
DongFeng	Phone	P3	UP3_BSGF187E000165
PHILIPS	Monitor	24PFF5595/T3	XM2A2124000343
PHILIPS	Mouse	SPK7214	M214BQ210411615
IPRO	Earphone	Phonenix 5.0s	EP221126001
SanDisk	TF Card	32 GB	521005904698

### 1.2.3 Support Cable List and Details

Cable Description	Shielding Type	Ferrite Core	Length (m)	From Port	To
HDMI Cable	No	No	1	EUT	Monitor
USB Cable	No	No	0.8	EUT	Phone
Mouse Cable	No	No	1.2	EUT	Mouse
Earphone Cable	No	No	1.2	EUT	Earphone

### 1.2.4 Block Diagram of Test Setup

AC line conducted emissions:

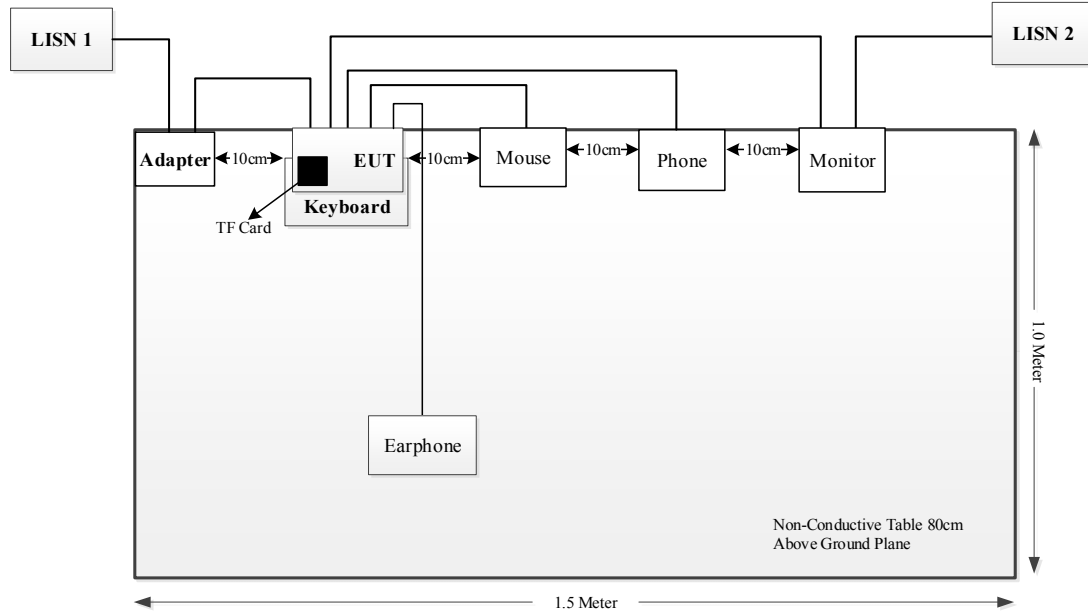

Spurious Emissions:

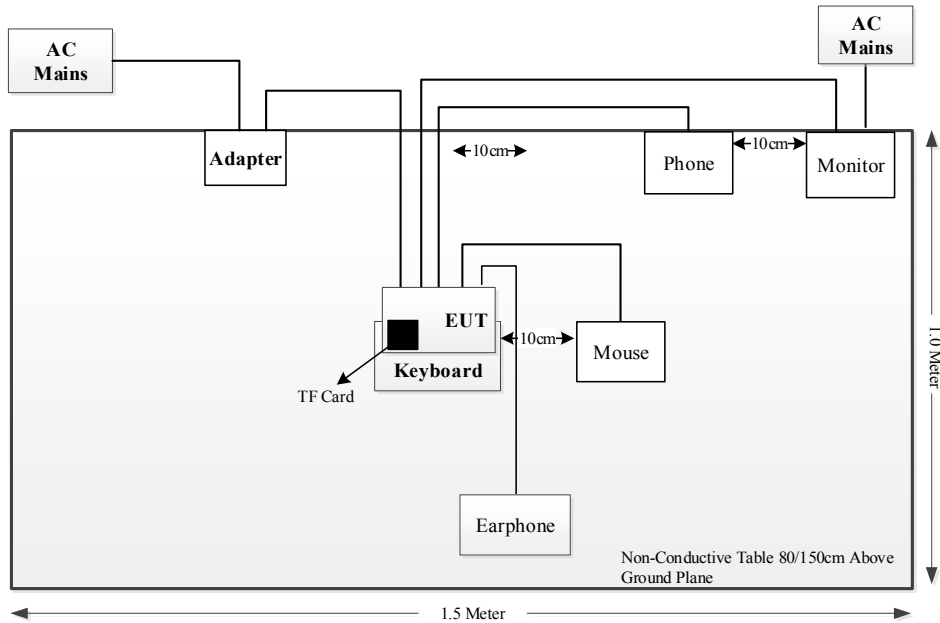

### 1.3 Measurement Uncertainty

Otherwise required by the applicant or Product Regulations, Decision Rule in this report did not consider the uncertainty. The extended uncertainty given in this report is obtained by combining the standard uncertainty times the coverage factor K with the 95% confidence interval.

Parameter	Measurement Uncertainty
Occupied Channel Bandwidth	±5 %
RF output power, conducted	±0.61dB
Power Spectral Density, conducted	±0.61 dB
Unwanted Emissions, radiated	30M~200MHz: 4.15 dB,200M~1GHz: 5.61 dB,1G~6GHz: 5.14 dB, 6G~18GHz: 5.93 dB,18G~26.5G:5.47 dB,26.5G~40G:5.63 dB
Unwanted Emissions, conducted	±1.26 dB
Temperature	±1 °C
Humidity	±5%
DC and low frequency voltages	±0.4%
Duty Cycle	1%
AC Power Lines Conducted Emission	2.8 dB (150 kHz to 30 MHz)

## 2. SUMMARY OF TEST RESULTS

Standard(s) Section	Test Items	Result
§15.207(a)	AC Line Conducted Emissions	Compliant
§15.205, §15.209, §15.247(d)	Spurious Emissions	Compliant
§15.247 (a)(2)	Minimum 6 dB Bandwidth	Compliant
§15.247(b)(3)	Maximum Conducted Output Power	Compliant
§15.247(d)	100 kHz Bandwidth of Frequency Band Edge	Compliant
§15.247(e)	Power Spectral Density	Compliant
§15.203	Antenna Requirement	Compliant

### 3. REQUIREMENTS AND TEST PROCEDURES

#### 3.1 AC Line Conducted Emissions

##### 3.1.1 Applicable Standard

FCC§15.207(a).

(a) Except as shown in paragraphs (b) and (c) of this section, for an intentional radiator that is designed to be connected to the public utility (AC) power line, the radio frequency voltage that is conducted back onto the AC power line on any frequency or frequencies, within the band 150 kHz to 30 MHz, shall not exceed the limits in the following table, as measured using a 50  $\mu$ H/50 ohms line impedance stabilization network (LISN). Compliance with the provisions of this paragraph shall be based on the measurement of the radio frequency voltage between each power line and ground at the power terminal. The lower limit applies at the boundary between the frequency ranges.

Frequency of emission (MHz)	Conducted limit (dB $\mu$ V)	
	Quasi-peak	Average
0.15-0.5	66 to 56*	56 to 46*
0.5-5	56	46
5-30	60	50

\*Decreases with the logarithm of the frequency.

(b) The limit shown in paragraph (a) of this section shall not apply to carrier current systems operating as intentional radiators on frequencies below 30 MHz. In lieu thereof, these carrier current systems shall be subject to the following standards:

(1) For carrier current system containing their fundamental emission within the frequency band 535-1705 kHz and intended to be received using a standard AM broadcast receiver: no limit on conducted emissions.

(2) For all other carrier current systems: 1000  $\mu$ V within the frequency band 535-1705 kHz, as measured using a 50  $\mu$ H/50 ohms LISN.

(3) Carrier current systems operating below 30 MHz are also subject to the radiated emission limits in §15.205, §15.209, §15.221, §15.223, or §15.227, as appropriate.

(c) Measurements to demonstrate compliance with the conducted limits are not required for devices which only employ battery power for operation and which do not operate from the AC power lines or contain provisions for operation while connected to the AC power lines. Devices that include, or make provisions for, the use of battery chargers which permit operating while charging, AC adapters or battery eliminators or that connect to the AC power lines indirectly, obtaining their power through another device which is connected to the AC power lines, shall be tested to demonstrate compliance with the conducted limits.

### 3.1.2 EUT Setup



- Note: 1. Support units were connected to second LISN.  
 2. Both of LISNs (AMN) 80 cm from EUT and at the least 80 cm from other units and other metal planes support units.

The setup of EUT is according with per ANSI C63.10-2013 measurement procedure. The specification used was with the FCC Part 15.207 limits.

The spacing between the peripherals was 10 cm.

The adapter or EUT was connected to the main LISN with a 120 V/60 Hz AC power source.

### 3.1.3 EMI Test Receiver Setup

The EMI test receiver was set to investigate the spectrum from 150 kHz to 30 MHz.

During the conducted emission test, the EMI test receiver was set with the following configurations:

Frequency Range	IF B/W
150 kHz – 30 MHz	9 kHz

### 3.1.4 Test Procedure

The frequency and amplitude of the six highest ac power-line conducted emissions relative to the limit, measured over all the current-carrying conductors of the EUT power cords, and the operating frequency or frequency to which the EUT is tuned (if appropriate), should be reported, unless such emissions are more than 20 dB below the limit. AC power-line conducted emissions measurements are to be separately carried out only on each of the phase (“hot”) line(s) and (if used) on the neutral line(s), but not on the ground [protective earth] line(s). If less than six emission frequencies are within 20 dB of the limit, then the noise level of the measuring instrument at representative frequencies should be reported. The specific conductor of the power-line cord for each of the reported emissions should be identified. Measure the six highest emissions with respect to the limit on each current-carrying conductor of each power cord associated with the EUT (but not the power cords of associated or peripheral equipment that are part of the test configuration). Then, report the six highest emissions with respect to the limit from among all the measurements identifying the frequency and specific current-carrying conductor identified with the emission. The six highest emissions should be reported for each of the current-carrying conductors, or the six highest emissions may be reported over all the current-carrying conductors.

### 3.1.5 Corrected Amplitude & Margin Calculation

The basic equation is as follows:

Result = Reading + Factor

Factor = attenuation caused by cable loss + voltage division factor of AMN

The “**Margin**” column of the following data tables indicates the degree of compliance within the applicable limit. The equation for margin calculation is as follows:

Margin = Limit – Result

## 3.2 Radiation Spurious Emissions

### 3.2.1 Applicable Standard

FCC §15.247 (d);

In any 100 kHz bandwidth outside the frequency band in which the spread spectrum or digitally modulated intentional radiator is operating, the radio frequency power that is produced by the intentional radiator shall be at least 20 dB below that in the 100 kHz bandwidth within the band that contains the highest level of the desired power, based on either an RF conducted or a radiated measurement, provided the transmitter demonstrates compliance with the peak conducted power limits. If the transmitter complies with the conducted power limits based on the use of RMS averaging over a time interval, as permitted under paragraph (b)(3) of this section, the attenuation required under this paragraph shall be 30 dB instead of 20 dB. Attenuation below the general limits specified in §15.209(a) is not required. In addition, radiated emissions which fall in the restricted bands, as defined in §15.205(a), must also comply with the radiated emission limits specified in §15.209(a) (see §15.205(c)).

### 3.2.2 EUT Setup

#### Below 1GHz:

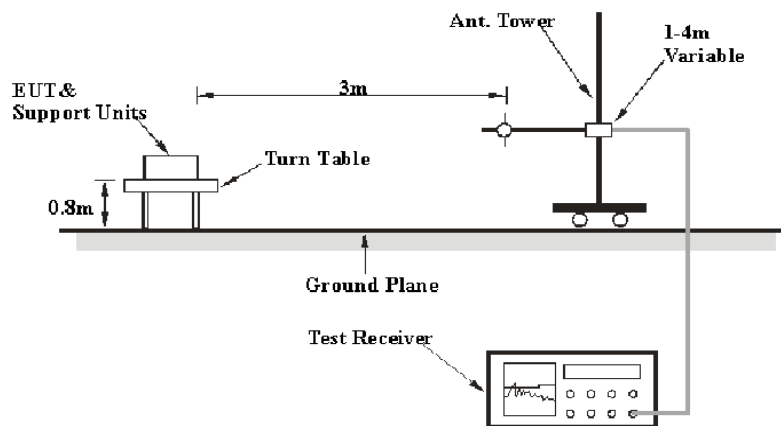

#### Above 1GHz:

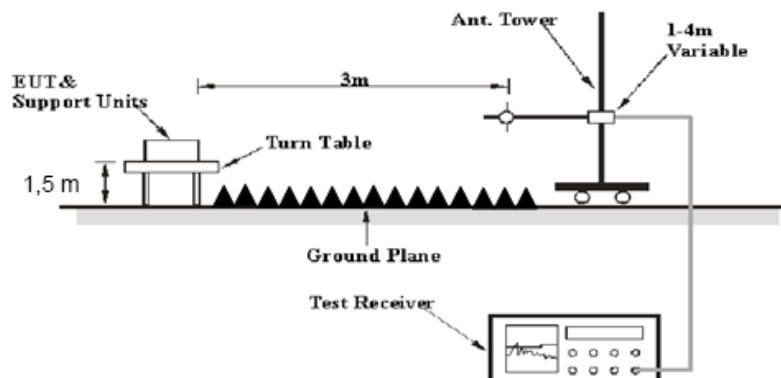

The radiated emissions were performed in the 3 meters distance, using the setup accordance with the ANSI C63.10-2013. The specification used was the FCC 15.209, and FCC 15.247 limits.



The external I/O cables were draped along the test table and formed a bundle 30 to 40 cm long in the middle.

The spacing between the peripherals was 10 cm.

### 3.2.3 EMI Test Receiver & Spectrum Analyzer Setup

The system was investigated from 9 kHz to 25 GHz.

During the radiated emission test, the EMI test receiver & Spectrum Analyzer Setup were set with the following configurations:

9 kHz -1000MHz:

Frequency Range	RBW	Video B/W	Detector
9 kHz – 150 kHz	200 Hz	1 kHz	QP
150 kHz – 30 MHz	9 kHz	30 kHz	QP
30 MHz – 1000 MHz	120 kHz	300 kHz	QP

1GHz- 25GHz:

Measurement	Duty cycle	RBW	Video B/W
PK	Any	1MHz	3 MHz
Ave.	>98%	1MHz	10 Hz
	<98%	1MHz	$\geq 1/T$

Note: T is minimum transmission duration

If the maximized peak measured value complies with under the QP/Average limit more than 6dB, then it is unnecessary to perform an QP/Average measurement.

### 3.2.4 Test Procedure

Maximizing procedure was performed on the highest emissions to ensure that the EUT complied with all installation combinations.

Data was recorded in Quasi-peak detection mode for frequency range of 30 MHz-1 GHz, peak and Average detection modes for frequencies above 1 GHz.

All emissions under the average limit and under the noise floor have not recorded in the report.

### 3.2.5 Corrected Amplitude & Margin Calculation

The basic equation is as follows:

Result = Reading + Factor

Factor = Antenna Factor + Cable Loss- Amplifier Gain

The “**Margin**” column of the following data tables indicates the degree of compliance within the applicable limit. The equation for margin calculation is as follows:

Margin = Limit – Result

### 3.3 Minimum 6 dB Emission Bandwidth

#### 3.3.1 Applicable Standard

FCC §15.247 (a)(2)

Systems using digital modulation techniques may operate in the 902-928 MHz, 2400-2483.5 MHz, and 5725-5850 MHz bands. The minimum 6 dB bandwidth shall be at least 500 kHz.

#### 3.3.2 EUT Setup

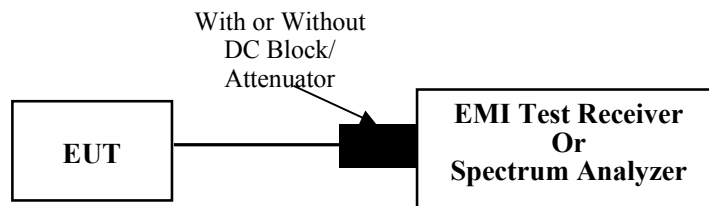

#### 3.3.3 Test Procedure

According to ANSI C63.10-2013 Section 11.8

- a) Set RBW = 100 kHz.
- b) Set the video bandwidth (VBW)  $\geq 3 \times$  RBW.
- c) Detector = Peak.
- d) Trace mode = max hold.
- e) Sweep = auto couple.
- f) Allow the trace to stabilize.
- g) Measure the maximum width of the emission that is constrained by the frequencies associated with the two outermost amplitude points (upper and lower frequencies) that are attenuated by 6 dB relative to the maximum level measured in the fundamental emission.

### 3.4 99% Occupied Bandwidth

#### 3.4.1 EUT Setup

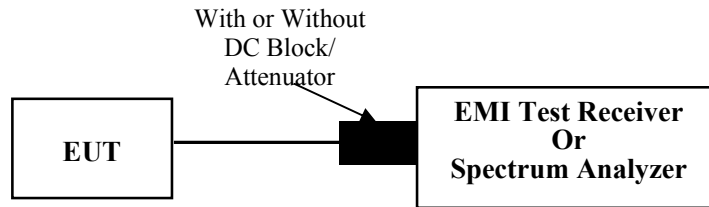

#### 3.4.2 Test Procedure

According to ANSI C63.10-2013 Section 6.9.3

The occupied bandwidth is the frequency bandwidth such that, below its lower and above its upper frequency limits, the mean powers are each equal to 0.5% of the total mean power of the given emission. The following procedure shall be used for measuring 99% power bandwidth:

- a) The instrument center frequency is set to the nominal EUT channel center frequency. The frequency span for the spectrum analyzer shall be between 1.5 times and 5.0 times the OBW.
- b) The nominal IF filter bandwidth (3 dB RBW) shall be in the range of 1% to 5% of the OBW, and VBW shall be approximately three times the RBW, unless otherwise specified by the applicable requirement.
- c) Set the reference level of the instrument as required, keeping the signal from exceeding the maximum input mixer level for linear operation. In general, the peak of the spectral envelope shall be more than  $[10 \log (OBW/RBW)]$  below the reference level. Specific guidance is given in 4.1.5.2.
- d) Step a) through step c) might require iteration to adjust within the specified range.
- e) Video averaging is not permitted. Where practical, a sample detection and single sweep mode shall be used. Otherwise, peak detection and max hold mode (until the trace stabilizes) shall be used.
- f) Use the 99% power bandwidth function of the instrument (if available) and report the measured bandwidth.
- g) If the instrument does not have a 99% power bandwidth function, then the trace data points are recovered and directly summed in linear power terms. The recovered amplitude data points, beginning at the lowest frequency, are placed in a running sum until 0.5% of the total is reached; that frequency is recorded as the lower frequency. The process is repeated until 99.5% of the total is reached; that frequency is recorded as the upper frequency. The 99% power bandwidth is the difference between these two frequencies.
- h) The occupied bandwidth shall be reported by providing plot(s) of the measuring instrument display; the plot axes and the scale units per division shall be clearly labeled. Tabular data may be reported in addition to the plot(s).

### 3.5 Maximum Conducted Output Power

#### 3.5.1 Applicable Standard

FCC §15.247 (b)(3)

For systems using digital modulation in the 902-928 MHz, 2400-2483.5 MHz, and 5725-5850 MHz bands: 1 Watt. As an alternative to a peak power measurement, compliance with the one Watt limit can be based on a measurement of the maximum conducted output power. Maximum Conducted Output Power is defined as the total transmit power delivered to all antennas and antenna elements averaged across all symbols in the signaling alphabet when the transmitter is operating at its maximum power control level. Power must be summed across all antennas and antenna elements. The average must not include any time intervals during which the transmitter is off or is transmitting at a reduced power level. If multiple modes of operation are possible (e.g., alternative modulation methods), the maximum conducted output power is the highest total transmit power occurring in any mode.

#### 3.5.2 EUT Setup

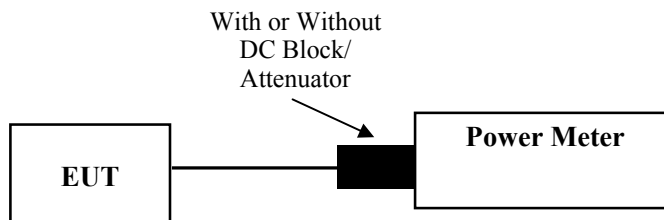

#### 3.5.3 Test Procedure

For Peak Power

According to ANSI C63.10-2013 Section 11.9.1.3

The maximum peak conducted output power may be measured using a broadband peak RF power meter. The power meter shall have a video bandwidth that is greater than or equal to the DTS bandwidth and shall use a fast-responding diode detector.

For Average Power

According to ANSI C63.10-2013 Section 11.9.2.3.2

Method AVGPM-G is a measurement using a gated RF average power meter.

Alternatively, measurements may be performed using a wideband gated RF power meter provided that the gate parameters are adjusted such that the power is measured only when the EUT is transmitting at its maximum power control level. Because the measurement is made only during the ON time of the transmitter, no duty cycle correction factor is required.

### 3.6 Maximum Power Spectral Density

#### 3.6.1 Applicable Standard

FCC §15.247 (e)

For digitally modulated systems, the power spectral density conducted from the intentional radiator to the antenna shall not be greater than 8 dBm in any 3 kHz band during any time interval of continuous transmission. This power spectral density shall be determined in accordance with the provisions of paragraph (b) of this section. The same method of determining the conducted output power shall be used to determine the power spectral density.

#### 3.6.2 EUT Setup

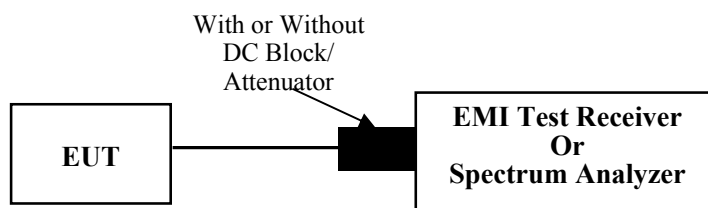

#### 3.6.3 Test Procedure

According to ANSI C63.10-2013 Section 11.10.2

- a) Set analyzer center frequency to DTS channel center frequency.
- b) Set the span to 1.5 times the DTS bandwidth.
- c) Set the RBW to  $3 \text{ kHz} \leq \text{RBW} \leq 100 \text{ kHz}$ .
- d) Set the VBW  $\geq [3 \times \text{RBW}]$ .
- e) Detector = peak.
- f) Sweep time = auto couple.
- g) Trace mode = max hold.
- h) Allow trace to fully stabilize.
- i) Use the peak marker function to determine the maximum amplitude level within the RBW.
- j) If measured value exceeds requirement, then reduce RBW (but no less than 3 kHz) and repeat.

### 3.7 100 kHz Bandwidth of Frequency Band Edge

#### 3.7.1 Applicable Standard

FCC §15.247 (d);

In any 100 kHz bandwidth outside the frequency band in which the spread spectrum or digitally modulated intentional radiator is operating, the radio frequency power that is produced by the intentional radiator shall be at least 20 dB below that in the 100 kHz bandwidth within the band that contains the highest level of the desired power, based on either an RF conducted or a radiated measurement, provided the transmitter demonstrates compliance with the peak conducted power limits. If the transmitter complies with the conducted power limits based on the use of RMS averaging over a time interval, as permitted under paragraph (b)(3) of this section, the attenuation required under this paragraph shall be 30 dB instead of 20 dB. Attenuation below the general limits specified in §15.209(a) is not required. In addition, radiated emissions which fall in the restricted bands, as defined in §15.205(a), must also comply with the radiated emission limits specified in §15.209(a) (see §15.205(c)).

#### 3.7.2 EUT Setup

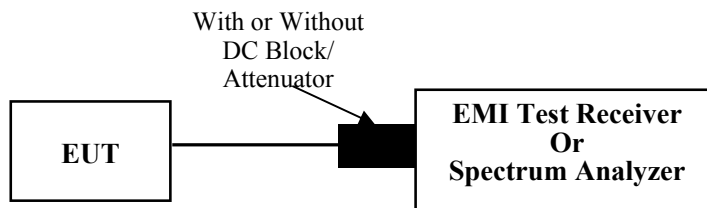

#### 3.7.3 Test Procedure

According to ANSI C63.10-2013 Section 11.11

- a) Set the center frequency and span to encompass frequency range to be measured.
- b) Set the RBW = 100 kHz.
- c) Set the VBW  $\geq [3 \times \text{RBW}]$ .
- d) Detector = peak.
- e) Sweep time = auto couple.
- f) Trace mode = max hold.
- g) Allow trace to fully stabilize.
- h) Use the peak marker function to determine the maximum amplitude level.

Ensure that the amplitude of all unwanted emissions outside of the authorized frequency band (excluding restricted frequency bands) is attenuated by at least the minimum requirements specified in 11.11. Report the three highest emissions relative to the limit.

### 3.8 Duty Cycle

#### 3.8.1 EUT Setup

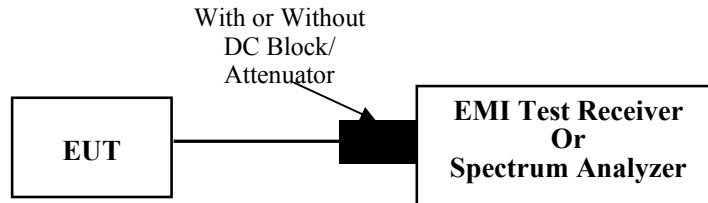

#### 3.8.2 Test Procedure

According to ANSI C63.10-2013 Section 11.6

The zero-span mode on a spectrum analyzer or EMI receiver if the response time and spacing between bins on the sweep are sufficient to permit accurate measurements of the ON and OFF times of the transmitted signal:

- 1) Set the center frequency of the instrument to the center frequency of the transmission.
- 2) Set  $RBW \geq OBW$  if possible; otherwise, set RBW to the largest available value.
- 3) Set  $VBW \geq RBW$ . Set detector = peak or average.
- 4) The zero-span measurement method shall not be used unless both RBW and VBW are  $> 50/T$  and the number of sweep points across duration T exceeds 100. (For example, if VBW and/or RBW are limited to 3 MHz, then the zero-span method of measuring the duty cycle shall not be used if  $T \leq 16.7 \mu s$ .)

### 3.9 Antenna Requirement

#### 3.9.1 Applicable Standard

FCC §15.203

An intentional radiator shall be designed to ensure that no antenna other than that furnished by the responsible party shall be used with the device. The use of a permanently attached antenna or of an antenna that uses a unique coupling to the intentional radiator shall be considered sufficient to comply with the provisions of this section. The manufacturer may design the unit so that a broken antenna can be replaced by the user, but the use of a standard antenna jack or electrical connector is prohibited. This requirement does not apply to carrier current devices or to devices operated under the provisions of §§15.211, 15.213, 15.217, 15.219, 15.221, or §15.236. Further, this requirement does not apply to intentional radiators that must be professionally installed, such as perimeter protection systems and some field disturbance sensors, or to other intentional radiators which, in accordance with §15.31(d), must be measured at the installation site. However, the installer shall be responsible for ensuring that the proper antenna is employed so that the limits in this part are not exceeded.

#### 3.9.2 Judgment

**Compliant.** Please refer to the Antenna Information detail in Section 1.

## 4. Test DATA AND RESULTS

### 4.1 AC Line Conducted Emissions

Serial Number:	2B1F-1	Test Date:	2023/09/13
Test Site:	CE	Test Mode:	Transmitting (Tested at maximum output power mode (802.11n ht40 high channel))
Tester:	Vic Du	Test Result:	Pass

#### Environmental Conditions:

Temperature: (°C)	26.1	Relative Humidity: (%)	67	ATM Pressure: (kPa)	99.6
----------------------	------	---------------------------	----	------------------------	------

#### Test Equipment List and Details:

Manufacturer	Description	Model	Serial Number	Calibration Date	Calibration Due Date
R&S	LISN	ENV216	101134	2023/03/31	2024/03/30
R&S	LISN	ENV216	101132	2023/03/31	2024/03/30
R&S	EMI Test Receiver	ESR3	102726	2023/03/31	2024/03/30
MICRO-COAX	Coaxial Cable	UTIFLEX	C-0200-01	2023/08/06	2024/08/05
Audix	Test Software	E3	190306 (V9)	N/A	N/A

\* Statement of Traceability: China Certification ICT Co., Ltd (Dongguan) attests that all calibrations have been performed, traceable to National Primary Standards and International System of Units (SI).

#### Test Data:

Please refer to the below plots.



Project No.: CR230952638-RF  
 Tester: Vic Du  
 Port: Line  
 Note:

Date: 2023-09-13

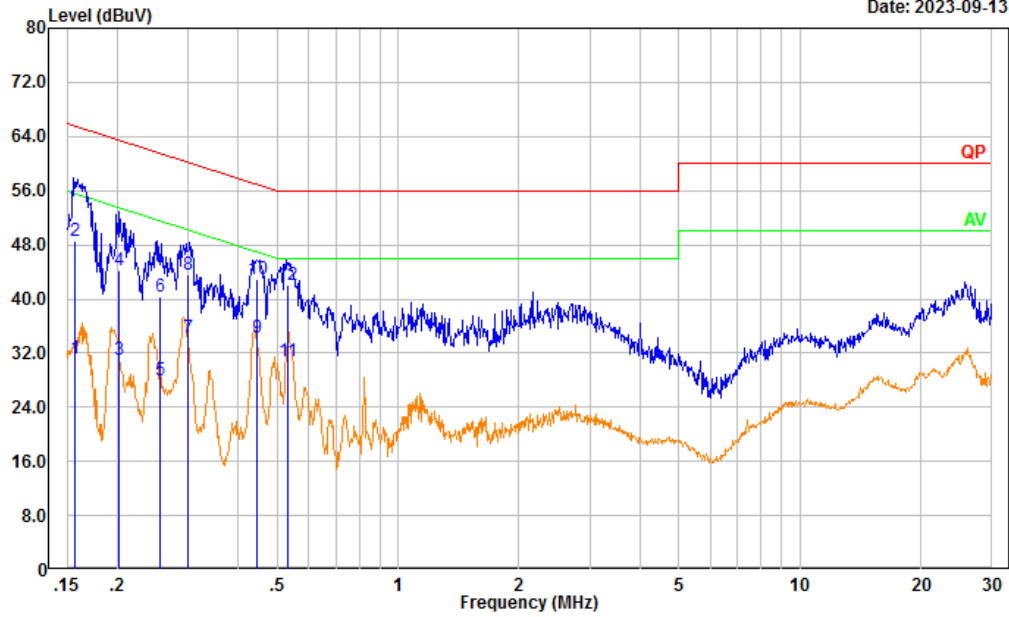

No.	Frequency (MHz)	Reading (dBuV)	Factor (dB)	Result (dBuV)	Limit (dBuV)	Margin (dB)	Detector
1	0.157	21.63	9.61	31.24	55.62	24.38	Average
2	0.157	39.04	9.61	48.65	65.62	16.97	QP
3	0.203	21.29	9.61	30.90	53.50	22.60	Average
4	0.203	34.55	9.61	44.16	63.50	19.34	QP
5	0.256	18.33	9.61	27.94	51.55	23.61	Average
6	0.256	30.75	9.61	40.36	61.55	21.19	QP
7	0.299	24.59	9.61	34.20	50.26	16.06	Average
8	0.299	33.87	9.61	43.48	60.26	16.78	QP
9	0.445	24.54	9.61	34.15	46.97	12.82	Average
10	0.445	33.40	9.61	43.01	56.97	13.96	QP
11	0.530	21.27	9.61	30.88	46.00	15.12	Average
12	0.530	32.47	9.61	42.08	56.00	13.92	QP

Project No.: CR230952638-RF  
 Tester: Vic Du  
 Port: neutral  
 Note:

Date: 2023-09-13

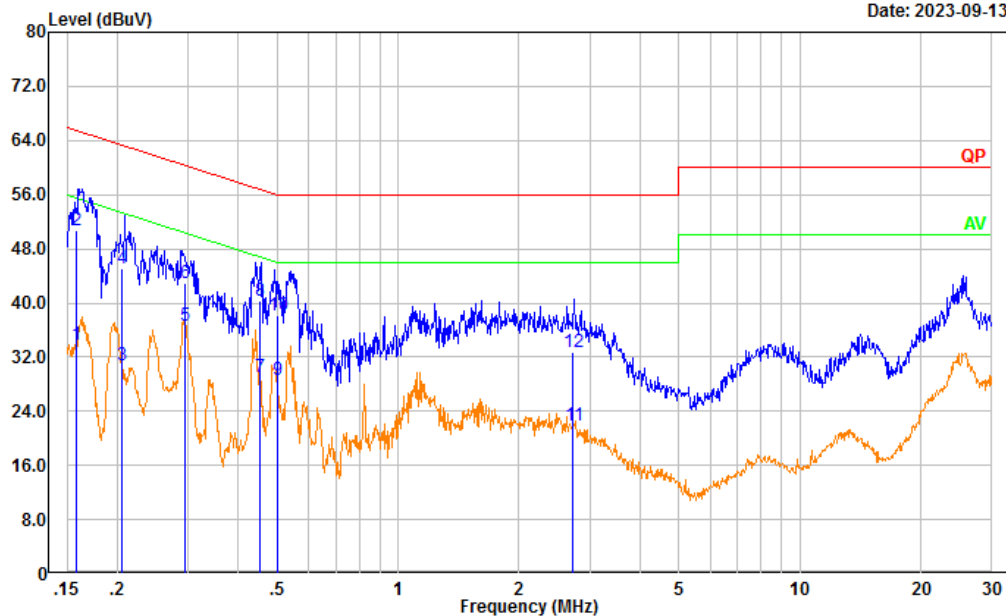

No.	Frequency (MHz)	Reading (dBμV)	Factor (dB)	Result (dBμV)	Limit (dBμV)	Margin (dB)	Detector
1	0.159	24.26	9.61	33.87	55.54	21.67	Average
2	0.159	41.08	9.61	50.69	65.54	14.85	QP
3	0.205	21.08	9.61	30.69	53.40	22.71	Average
4	0.205	35.54	9.61	45.15	63.40	18.25	QP
5	0.295	26.95	9.61	36.56	50.39	13.83	Average
6	0.295	33.33	9.61	42.94	60.39	17.45	QP
7	0.453	19.54	9.61	29.15	46.82	17.67	Average
8	0.453	30.66	9.61	40.27	56.82	16.55	QP
9	0.500	18.95	9.61	28.56	46.00	17.44	Average
10	0.500	28.50	9.61	38.11	56.00	17.89	QP
11	2.730	12.36	9.64	22.00	46.00	24.00	Average
12	2.730	23.16	9.64	32.80	56.00	23.20	QP

## 4.2 Radiation Spurious Emissions

Serial Number:	2B1F-1	Test Date:	2023/9/13~2023/9/14
Test Site:	966-2,966-1	Test Mode:	Transmitting
Tester:	Hugo Huo, Tao Zhu	Test Result:	Pass

### Environmental Conditions:

Temperature: (°C)	24.7~25.5	Relative Humidity: (%)	61~65	ATM Pressure: (kPa)	100
----------------------	-----------	---------------------------	-------	------------------------	-----

### Test Equipment List and Details:

Manufacturer	Description	Model	Serial Number	Calibration Date	Calibration Due Date
EMCO	Passive Loop Antenna	6512	9706-1209	2023/02/15	2026/02/14
Sunol Sciences	Antenna	JB6	A082520-5	2020/10/19	2023/10/18
R&S	EMI Test Receiver	ESR3	102724	2023/3/31	2024/3/30
TIMES MICROWAVE	Coaxial Cable	LMR-600-UltraFlex	C-0470-02	2023/7/16	2024/7/15
TIMES MICROWAVE	Coaxial Cable	LMR-600-UltraFlex	C-0780-01	2023/7/16	2024/7/15
Sonoma	Amplifier	310N	186165	2023/7/16	2024/7/15
ETS-Lindgren	Horn Antenna	3115	9912-5985	2020/10/13	2023/10/12
R&S	Spectrum Analyzer	FSV40	101591	2023/3/31	2024/3/30
MICRO-COAX	Coaxial Cable	UFA210A-1-1200-70U300	217423-008	2023/8/6	2024/8/5
MICRO-COAX	Coaxial Cable	UFA210A-1-2362-300300	235780-001	2023/8/6	2024/8/5
Mini	Pre-amplifier	ZVA-183-S+	5969001149	2022/11/9	2023/11/8
Audix	Test Software	E3	201021 (V9)	N/A	N/A
PASTERNAK	Horn Antenna	PE9852/2F-20	112002	2021/2/5	2024/2/4
Quinstar	Preamplifier	QLW-18405536-JO	15964001005	2022/9/16	2023/9/15
MICRO-COAX	Coaxial Cable	UFB142A-1-2362-200200	235772-001	2023/8/6	2024/8/5
E-Microwave	Band Rejection Filter	2400-2483.5MHz	OE01902424	2023/8/6	2024/8/5
Mini Circuits	High Pass Filter	VHF-6010+	31119	2023/8/6	2024/8/5

\* Statement of Traceability: China Certification ICT Co., Ltd (Dongguan) attests that all calibrations have been performed, traceable to National Primary Standards and International System of Units (SI).

**Test Data:**

Please refer to the below table and plots.

The maximum value of the fundamental on the X-axis:99.95dB $\mu$ V\*(worst case position);

The maximum value of the fundamental on the Y-axis:99.08dB $\mu$ V;

The maximum value of the fundamental on the Z-axis:99.08dB $\mu$ V.

(The pre-scan performed on 802.11n ht40 mode high channel 2452MHz)

After pre-scan in the X, Y and Z axes of orientation, the worst case X is below:

**1) 9kHz~30MHz**

The amplitude of spurious emissions attenuated more than 20 dB below the permissible value is not required to be report.

2) 30MHz-1GHz (Tested at maximum output power mode (802.11n ht40 high channel))

Project No.: CR230952638-RF  
 Tester: Hugo Huo  
 Polarization: horizontal  
 Note:

Date: 2023-09-13

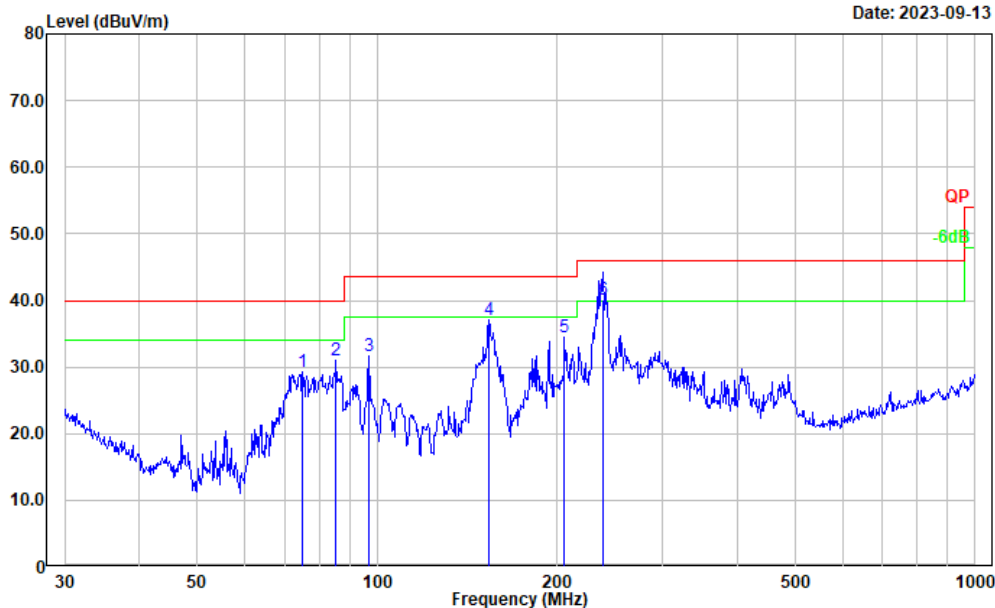

No.	Frequency (MHz)	Reading (dBμV)	Factor (dB/m)	Result (dBμV/m)	Limit (dBμV/m)	Margin (dB)	Detector
1	74.919	46.18	-16.92	29.26	40.00	10.74	Peak
2	85.298	48.17	-17.19	30.98	40.00	9.02	Peak
3	96.775	46.69	-15.13	31.56	43.50	11.94	Peak
4	153.739	49.02	-12.01	37.01	43.50	6.49	Peak
5	205.675	46.79	-12.37	34.42	43.50	9.08	Peak
6	239.147	53.16	-13.03	40.13	46.00	5.87	QP

Project No.: CR230952638-RF  
 Tester: Hugo Huo  
 Polarization: vertical  
 Note:

Date: 2023-09-13

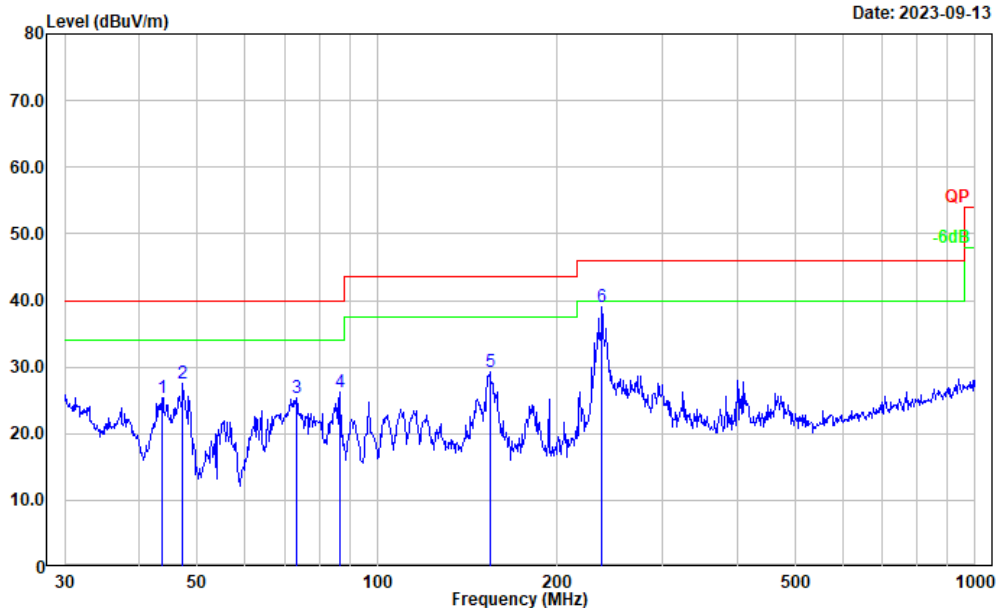

No.	Frequency (MHz)	Reading (dBμV)	Factor (dB/m)	Result (dBμV/m)	Limit (dBμV/m)	Margin (dB)	Detector
1	43.659	38.73	-13.46	25.27	40.00	14.73	Peak
2	47.326	43.14	-15.62	27.52	40.00	12.48	Peak
3	73.103	42.06	-16.75	25.31	40.00	14.69	Peak
4	86.807	43.33	-17.10	26.23	40.00	13.77	Peak
5	154.279	41.33	-12.03	29.30	43.50	14.20	Peak
6	237.476	52.03	-13.05	38.98	46.00	7.02	Peak

**3) 1-25GHz:  
802.11b Mode:**

Frequency (MHz)	Receiver		Polar (H/V)	Factor (dB/m)	Result (dB $\mu$ V/m)	Limit (dB $\mu$ V/m)	Margin (dB)
	Reading (dB $\mu$ V)	Detector					
Low Channel: 2412 MHz							
2412.000	68.14	PK	H	31.53	99.67	N/A	N/A
2412.000	65.48	AV	H	31.53	97.01	N/A	N/A
2412.000	68.72	PK	V	31.53	100.25	N/A	N/A
2412.000	65.63	AV	V	31.53	97.16	N/A	N/A
2390.000	27.47	PK	V	31.46	58.93	74.00	15.07
2390.000	14.09	AV	V	31.46	45.55	54.00	8.45
4824.000	38.65	PK	V	10.94	49.59	74.00	24.41
4824.000	25.47	AV	V	10.94	36.41	54.00	17.59
7236.000	34.57	PK	V	14.44	49.01	74.00	24.99
7236.000	21.33	AV	V	14.44	35.77	54.00	18.23
Middle Channel: 2437 MHz							
2437.000	68.68	PK	H	31.60	100.28	N/A	N/A
2437.000	65.87	AV	H	31.60	97.47	N/A	N/A
2437.000	69.54	PK	V	31.60	101.14	N/A	N/A
2437.000	66.21	AV	V	31.60	97.81	N/A	N/A
4874.000	38.74	PK	V	11.05	49.79	74.00	24.21
4874.000	25.67	AV	V	11.05	36.72	54.00	17.28
7311.000	34.58	PK	V	14.80	49.38	74.00	24.62
7311.000	21.23	AV	V	14.80	36.03	54.00	17.97
High Channel: 2462MHz							
2462.000	69.85	PK	H	31.63	101.48	N/A	N/A
2462.000	66.47	AV	H	31.63	98.10	N/A	N/A
2462.000	70.25	PK	V	31.63	101.88	N/A	N/A
2462.000	67.36	AV	V	31.63	98.99	N/A	N/A
2483.500	27.46	PK	V	31.64	59.10	74.00	14.90
2483.500	14.28	AV	V	31.64	45.92	54.00	8.08
4924.000	39.45	PK	V	11.18	50.63	74.00	23.37
4924.000	26.54	AV	V	11.18	37.72	54.00	16.28
7386.000	34.52	PK	V	14.89	49.41	74.00	24.59
7386.000	21.41	AV	V	14.89	36.30	54.00	17.70

**802.11g Mode:**

Frequency (MHz)	Receiver		Polar (H/V)	Factor (dB/m)	Result (dB $\mu$ V/m)	Limit (dB $\mu$ V/m)	Margin (dB)
	Reading (dB $\mu$ V)	Detector					
Low Channel: 2412 MHz							
2412.000	69.86	PK	H	31.53	101.39	N/A	N/A
2412.000	58.72	AV	H	31.53	90.25	N/A	N/A
2412.000	70.51	PK	V	31.53	102.04	N/A	N/A
2412.000	59.89	AV	V	31.53	91.42	N/A	N/A
2390.000	27.38	PK	V	31.46	58.84	74.00	15.16
2390.000	14.54	AV	V	31.46	46.00	54.00	8.00
4824.000	38.65	PK	V	10.94	49.59	74.00	24.41
4824.000	25.47	AV	V	10.94	36.41	54.00	17.59
7236.000	34.27	PK	V	14.44	48.71	74.00	25.29
7236.000	21.32	AV	V	14.44	35.76	54.00	18.24
Middle Channel: 2437 MHz							
2437.000	70.42	PK	H	31.60	102.02	N/A	N/A
2437.000	59.54	AV	H	31.60	91.14	N/A	N/A
2437.000	70.82	PK	V	31.60	102.42	N/A	N/A
2437.000	59.38	AV	V	31.60	90.98	N/A	N/A
4874.000	38.66	PK	V	11.05	49.71	74.00	24.29
4874.000	25.25	AV	V	11.05	36.30	54.00	17.70
7311.000	34.78	PK	V	14.80	49.58	74.00	24.42
7311.000	21.30	AV	V	14.80	36.10	54.00	17.90
High Channel: 2462MHz							
2462.000	70.25	PK	H	31.63	101.88	N/A	N/A
2462.000	59.33	AV	H	31.63	90.96	N/A	N/A
2462.000	71.41	PK	V	31.63	103.04	N/A	N/A
2462.000	60.47	AV	V	31.63	92.10	N/A	N/A
2483.500	27.53	PK	V	31.64	59.17	74.00	14.83
2483.500	14.44	AV	V	31.64	46.08	54.00	7.92
4924.000	39.67	PK	V	11.18	50.85	74.00	23.15
4924.000	26.53	AV	V	11.18	37.71	54.00	16.29
7386.000	34.72	PK	V	14.89	49.61	74.00	24.39
7386.000	21.47	AV	V	14.89	36.36	54.00	17.64



**802.11n ht20 Mode:**

Frequency (MHz)	Receiver		Polar (H/V)	Factor (dB/m)	Result (dB $\mu$ V/m)	Limit (dB $\mu$ V/m)	Margin (dB)
	Reading (dB $\mu$ V)	Detector					
Low Channel: 2412 MHz							
2412.000	69.72	PK	H	31.53	101.25	N/A	N/A
2412.000	58.73	AV	H	31.53	90.26	N/A	N/A
2412.000	70.39	PK	V	31.53	101.92	N/A	N/A
2412.000	59.68	AV	V	31.53	91.21	N/A	N/A
2390.000	27.45	PK	V	31.46	58.91	74.00	15.09
2390.000	14.66	AV	V	31.46	46.12	54.00	7.88
4824.000	38.87	PK	V	10.94	49.81	74.00	24.19
4824.000	25.48	AV	V	10.94	36.42	54.00	17.58
7236.000	34.72	PK	V	14.44	49.16	74.00	24.84
7236.000	21.52	AV	V	14.44	35.96	54.00	18.04
Middle Channel: 2437 MHz							
2437.000	69.66	PK	H	31.60	101.26	N/A	N/A
2437.000	58.42	AV	H	31.60	90.02	N/A	N/A
2437.000	70.17	PK	V	31.60	101.77	N/A	N/A
2437.000	59.38	AV	V	31.60	90.98	N/A	N/A
4874.000	39.63	PK	V	11.05	50.68	74.00	23.32
4874.000	26.40	AV	V	11.05	37.45	54.00	16.55
7311.000	34.21	PK	V	14.80	49.01	74.00	24.99
7311.000	21.32	AV	V	14.80	36.12	54.00	17.88
High Channel: 2462MHz							
2462.000	69.78	PK	H	31.63	101.41	N/A	N/A
2462.000	58.63	AV	H	31.63	90.26	N/A	N/A
2462.000	70.74	PK	V	31.63	102.37	N/A	N/A
2462.000	59.62	AV	V	31.63	91.25	N/A	N/A
2483.500	27.44	PK	V	31.64	59.08	74.00	14.92
2483.500	14.52	AV	V	31.64	46.16	54.00	7.84
4924.000	39.17	PK	V	11.18	50.35	74.00	23.65
4924.000	26.39	AV	V	11.18	37.57	54.00	16.43
7386.000	34.41	PK	V	14.89	49.30	74.00	24.70
7386.000	21.20	AV	V	14.89	36.09	54.00	17.91

**802.11n ht40 Mode:**

Frequency (MHz)	Receiver		Polar (H/V)	Factor (dB/m)	Result (dB $\mu$ V/m)	Limit (dB $\mu$ V/m)	Margin (dB)
	Reading (dB $\mu$ V)	Detector					
Low Channel: 2422 MHz							
2422.000	65.58	PK	H	31.56	97.14	N/A	N/A
2422.000	54.71	AV	H	31.56	86.27	N/A	N/A
2422.000	66.17	PK	V	31.56	97.73	N/A	N/A
2422.000	55.78	AV	V	31.56	87.34	N/A	N/A
2390.000	28.15	PK	V	31.46	59.61	74.00	14.39
2390.000	14.87	AV	V	31.46	46.33	54.00	7.67
4844.000	38.45	PK	V	10.96	49.41	74.00	24.59
4844.000	25.32	AV	V	10.96	36.28	54.00	17.72
7266.000	34.72	PK	V	14.63	49.35	74.00	24.65
7266.000	21.48	AV	V	14.63	36.11	54.00	17.89
Middle Channel: 2437 MHz							
2437.000	66.38	PK	H	31.60	97.98	N/A	N/A
2437.000	55.41	AV	H	31.60	87.01	N/A	N/A
2437.000	67.83	PK	V	31.60	99.43	N/A	N/A
2437.000	56.34	AV	V	31.60	87.94	N/A	N/A
4874.000	38.66	PK	V	11.05	49.71	74.00	24.29
4874.000	24.72	AV	V	11.05	35.77	54.00	18.23
7311.000	34.38	PK	V	14.80	49.18	74.00	24.82
7311.000	21.46	AV	V	14.80	36.26	54.00	17.74
High Channel: 2452MHz							
2452.000	67.50	PK	H	31.63	99.13	N/A	N/A
2452.000	56.48	AV	H	31.63	88.11	N/A	N/A
2452.000	68.32	PK	V	31.63	99.95	N/A	N/A
2452.000	57.33	AV	V	31.63	88.96	N/A	N/A
2483.500	30.15	PK	V	31.64	61.79	74.00	12.21
2483.500	15.77	AV	V	31.64	47.41	54.00	6.59
4904.000	39.57	PK	V	11.14	50.71	74.00	23.29
4904.000	26.79	AV	V	11.14	37.93	54.00	16.07
7356.000	34.17	PK	V	14.80	48.97	74.00	25.03
7356.000	21.82	AV	V	14.80	36.62	54.00	17.38

**Worst Test plots (802.11n ht40 high channel was the worst)**

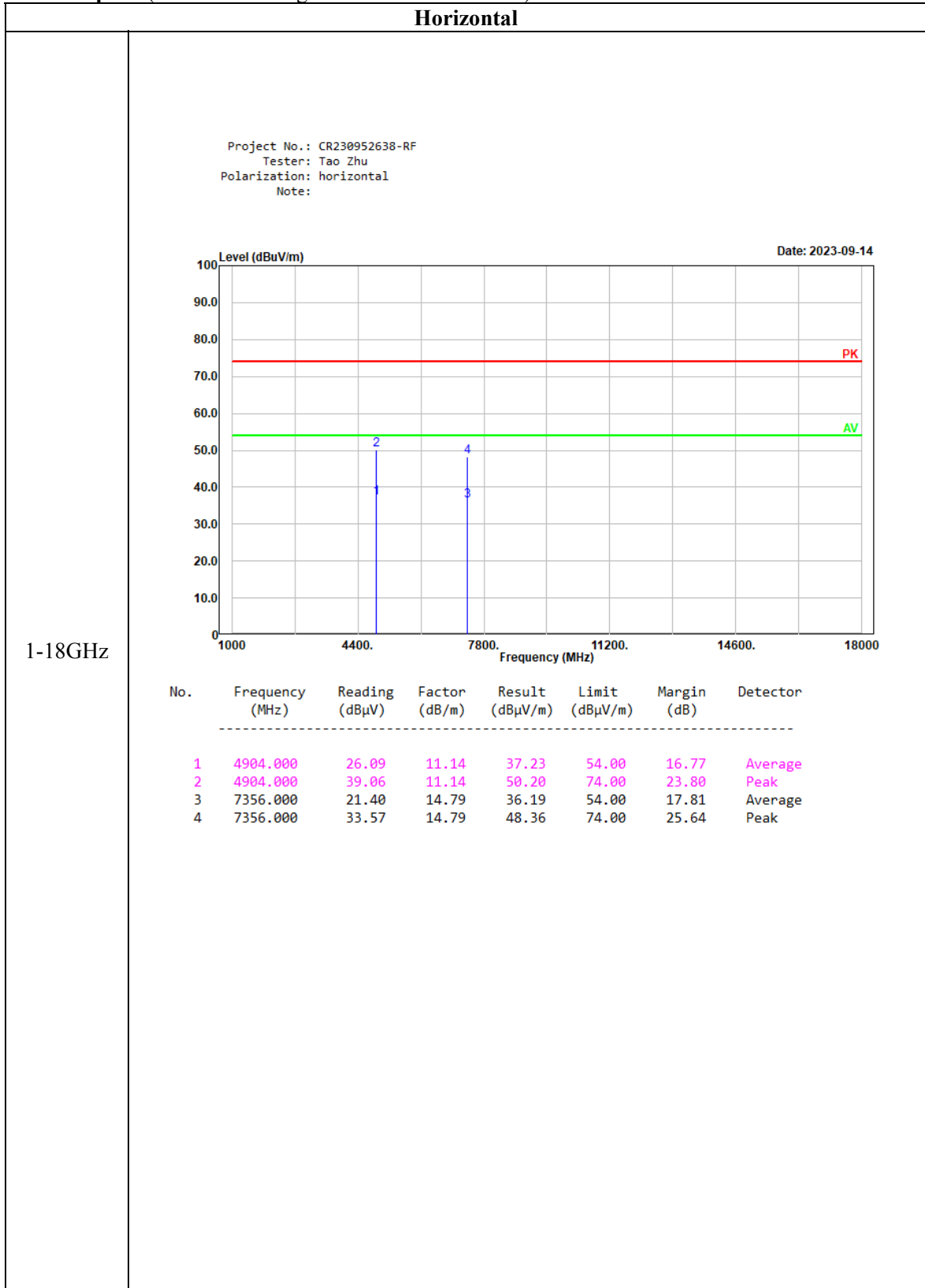

**Horizontal**

Project No.: CR230952638-RF  
 Tester: Tao Zhu  
 Polarization: Horizontal  
 Note:

Date: 2023-09-14

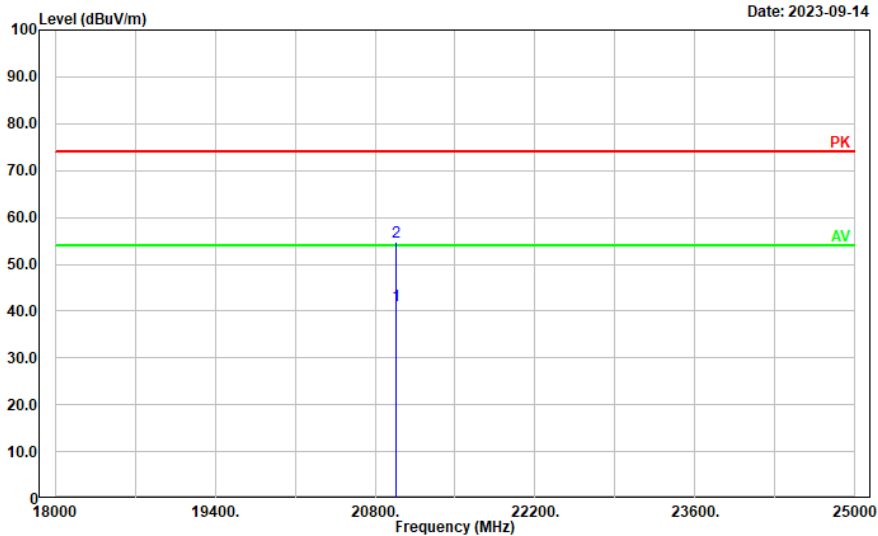

18-25GHz

No.	Frequency (MHz)	Reading (dBμV)	Factor (dB/m)	Result (dBμV/m)	Limit (dBμV/m)	Margin (dB)	Detector
1	20982.600	36.65	4.56	41.21	54.00	12.79	Average
2	20982.600	50.23	4.56	54.79	74.00	19.21	Peak

**Vertical**

Project No.: CR230952638-RF  
 Tester: Tao Zhu  
 Polarization: Vertical  
 Note:

Date: 2023-09-14

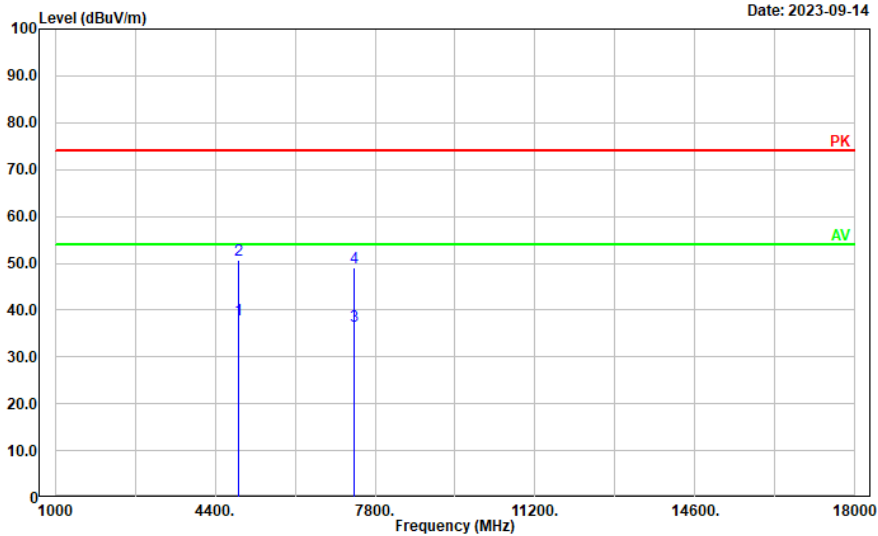

1-18GHz

No.	Frequency (MHz)	Reading (dBμV)	Factor (dB/m)	Result (dBμV/m)	Limit (dBμV/m)	Margin (dB)	Detector
1	4904.000	26.79	11.14	37.93	54.00	16.07	Average
2	4904.000	39.57	11.14	50.71	74.00	23.29	Peak
3	7356.000	21.82	14.79	36.61	54.00	17.39	Average
4	7356.000	34.17	14.79	48.96	74.00	25.04	Peak

**Vertical**

Project No.: CR230952638-RF  
 Tester: Tao Zhu  
 Polarization: Vertical  
 Note:

Date: 2023-09-14

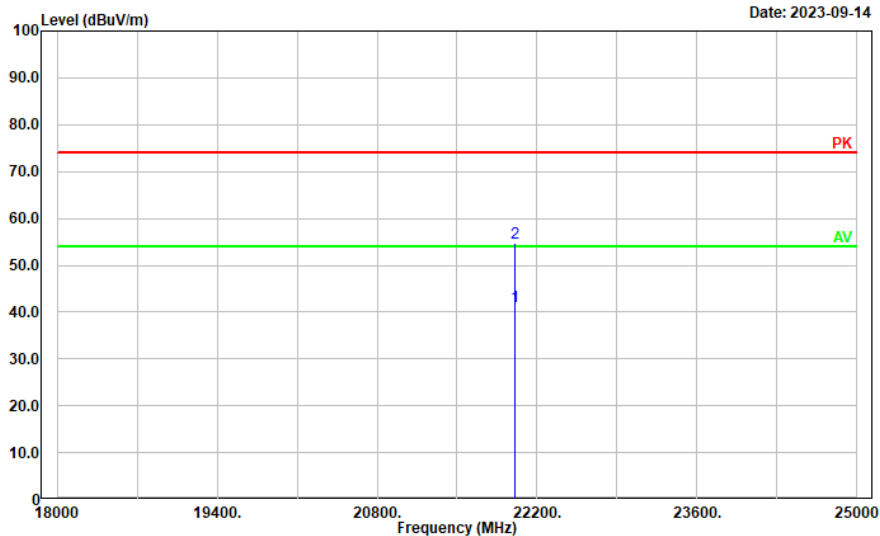

18-25GHz

No.	Frequency (MHz)	Reading (dBμV)	Factor (dB/m)	Result (dBμV/m)	Limit (dBμV/m)	Margin (dB)	Detector
1	22007.600	36.79	4.51	41.30	54.00	12.70	Average
2	22007.600	50.14	4.51	54.65	74.00	19.35	Peak

**4.3 Minimum 6 dB Emission Bandwidth**

Serial Number:	2B1F-2	Test Date:	2023/9/13
Test Site:	RF	Test Mode:	Transmitting
Tester:	Arthur Su	Test Result:	Pass

**Environmental Conditions:**

Temperature: (°C)	25.9	Relative Humidity: (%)	60	ATM Pressure: (kPa)	100
----------------------	------	------------------------------	----	------------------------	-----

**Test Equipment List and Details:**

Manufacturer	Description	Model	Serial Number	Calibration Date	Calibration Due Date
R&S	Spectrum Analyzer	FSU26	200256	2023/3/31	2024/3/30
zhuoxiang	Coaxial Cable	SMA-178	211001	Each time	N/A
eastsheep	Coaxial Attenuator	2W-SMA-JK-18G	21060301	Each time	N/A

\* Statement of Traceability: China Certification ICT Co., Ltd (Dongguan) attests that all calibrations have been performed, traceable to National Primary Standards and International System of Units (SI).

**Test Data:**

Test Modes	Test Frequency (MHz)	6 dB Bandwidth (MHz)	Limit (MHz)
802.11b	2412	8.08	0.5
	2437	8	0.5
	2462	7.6	0.5
802.11g	2412	15.2	0.5
	2437	15.12	0.5
	2462	15.12	0.5
802.11n ht20	2412	15.2	0.5
	2437	14.88	0.5
	2462	15.2	0.5
802.11n ht40	2422	35.68	0.5
	2437	34.08	0.5
	2452	34.08	0.5

Please refer to the below plots:

<b>6dB Emission Bandwidth</b>	
<p>802.11b Lowest Channel</p>	<p>ProjectNo.:CR230952638-RF Tester:Arthur Su Date: 13.SEP.2023 19:54:53</p>
<p>802.11b Middle Channel</p>	<p>ProjectNo.:CR230952638-RF Tester:Arthur Su Date: 13.SEP.2023 19:56:30</p>
<p>802.11b Highest Channel</p>	<p>ProjectNo.:CR230952638-RF Tester:Arthur Su Date: 13.SEP.2023 19:57:54</p>



<b>6dB Emission Bandwidth</b>	
802.11g Lowest Channel	<p>ProjectNo.:CR230952638-RF Tester:Arthur Su Date: 13.SEP.2023 19:59:45</p>
802.11g Middle Channel	<p>ProjectNo.:CR230952638-RF Tester:Arthur Su Date: 13.SEP.2023 20:01:31</p>
802.11g Highest Channel	<p>ProjectNo.:CR230952638-RF Tester:Arthur Su Date: 13.SEP.2023 20:03:01</p>

<b>6dB Emission Bandwidth</b>	
802.11n ht20 Lowest Channel	<p>ProjectNo.:CR230952638-RF Tester:Arthur Su Date: 13.SEP.2023 20:05:03</p>
802.11n ht20 Middle Channel	<p>ProjectNo.:CR230952638-RF Tester:Arthur Su Date: 13.SEP.2023 20:07:15</p>
802.11n ht20 Highest Channel	<p>ProjectNo.:CR230952638-RF Tester:Arthur Su Date: 13.SEP.2023 20:08:48</p>

6dB Emission Bandwidth	
<p>802.11n ht40 Lowest Channel</p>	<p>ProjectNo.:CR230952638-RF Tester:Arthur Su Date: 13.SEP.2023 20:10:44</p>
<p>802.11n ht40 Middle Channel</p>	<p>ProjectNo.:CR230952638-RF Tester:Arthur Su Date: 13.SEP.2023 20:13:33</p>
<p>802.11n ht40 Highest Channel</p>	<p>ProjectNo.:CR230952638-RF Tester:Arthur Su Date: 13.SEP.2023 20:15:47</p>

**4.4 99% Occupied Bandwidth**

Serial Number:	2B1F-2	Test Date:	2023/9/13
Test Site:	RF	Test Mode:	Transmitting
Tester:	Arthur Su	Test Result:	N/A

**Environmental Conditions:**

Temperature: (°C)	25.9	Relative Humidity: (%)	60	ATM Pressure: (kPa)	100
----------------------	------	---------------------------	----	------------------------	-----

**Test Equipment List and Details:**

Manufacturer	Description	Model	Serial Number	Calibration Date	Calibration Due Date
R&S	Spectrum Analyzer	FSU26	200256	2023/3/31	2024/3/30
zhuoxiang	Coaxial Cable	SMA-178	211001	Each time	N/A
eastsheep	Coaxial Attenuator	2W-SMA-JK-18G	21060301	Each time	N/A

\* Statement of Traceability: China Certification ICT Co., Ltd (Dongguan) attests that all calibrations have been performed, traceable to National Primary Standards and International System of Units (SI).

**Test Data:**

Test Modes	Test Channel	Test Frequency (MHz)	99% Occupied Bandwidth (MHz)
802.11b	Lowest	2412	13.12
	Middle	2437	13.12
	Highest	2462	13.12
802.11g	Lowest	2412	16.4
	Middle	2437	16.48
	Highest	2462	16.48
802.11n ht20	Lowest	2412	17.52
	Middle	2437	17.44
	Highest	2462	17.44
802.11n ht40	Lowest	2422	36.16
	Middle	2437	36.16
	Highest	2452	36.16

Please refer to the below plots:

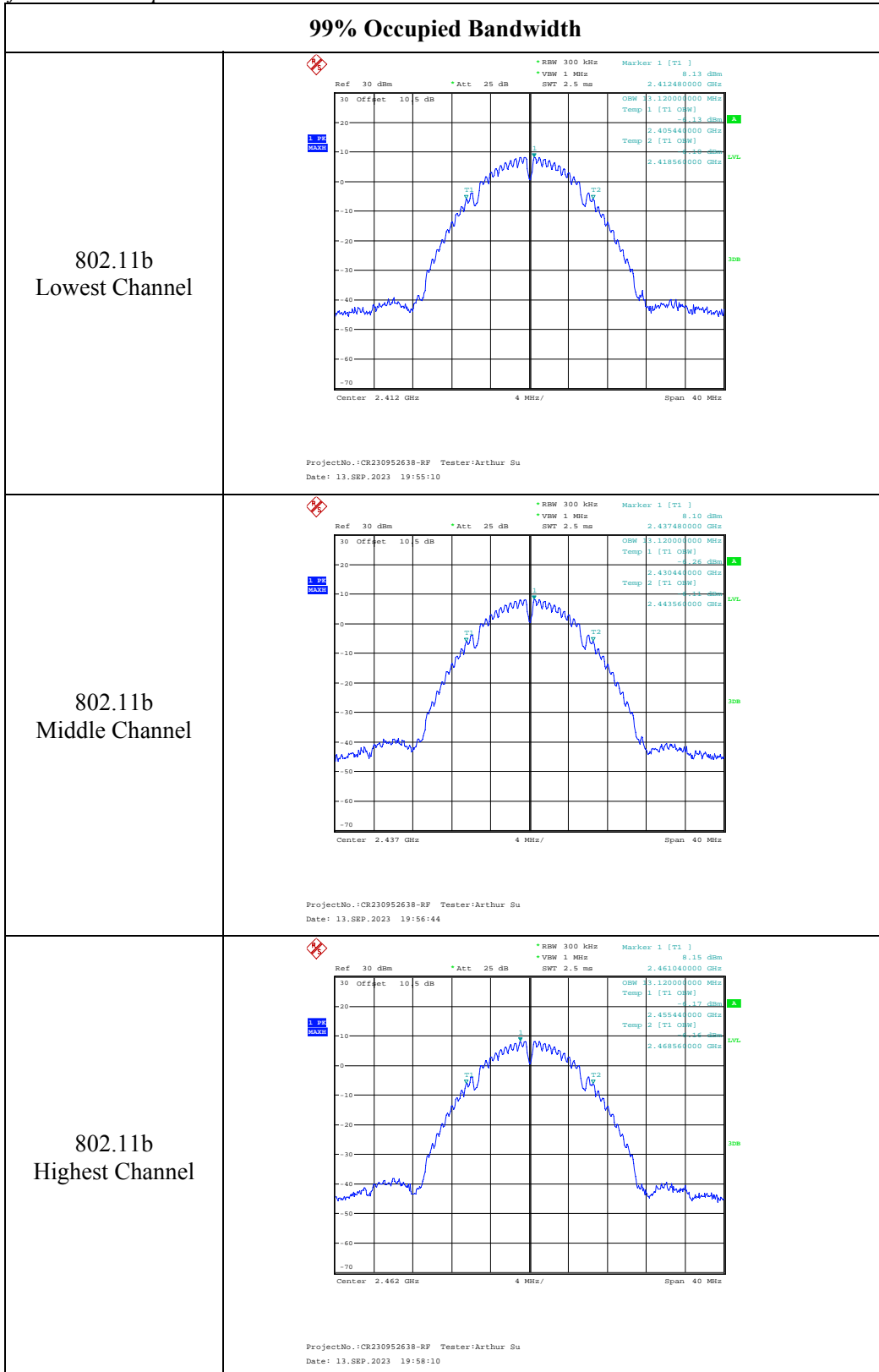

### 99% Occupied Bandwidth

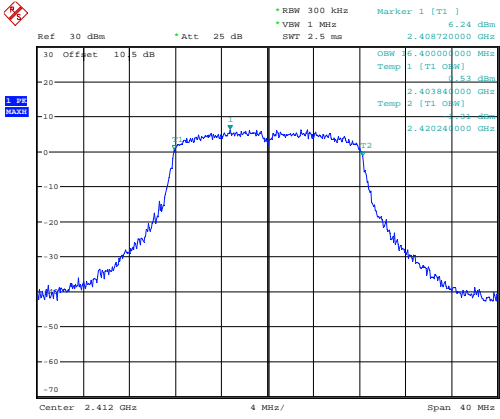
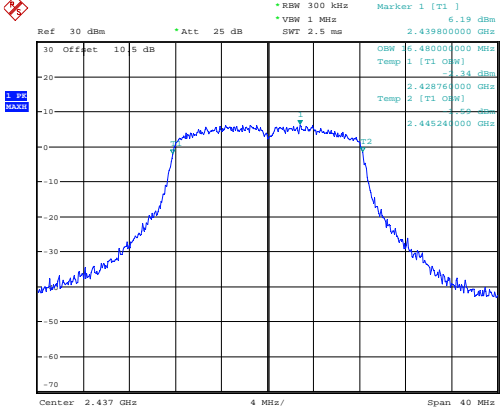
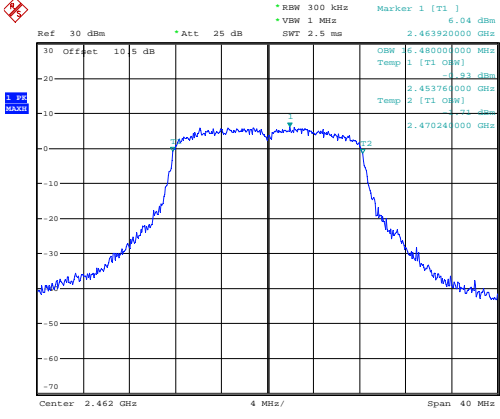
<p>802.11g Lowest Channel</p>	 <p>ProjectNo.:CR230952638-RF Tester:Arthur Su Date: 13.SEP.2023 20:00:06</p>
<p>802.11g Middle Channel</p>	 <p>ProjectNo.:CR230952638-RF Tester:Arthur Su Date: 13.SEP.2023 20:01:49</p>
<p>802.11g Highest Channel</p>	 <p>ProjectNo.:CR230952638-RF Tester:Arthur Su Date: 13.SEP.2023 20:03:20</p>

**99% Occupied Bandwidth**

802.11n ht20  
Lowest Channel

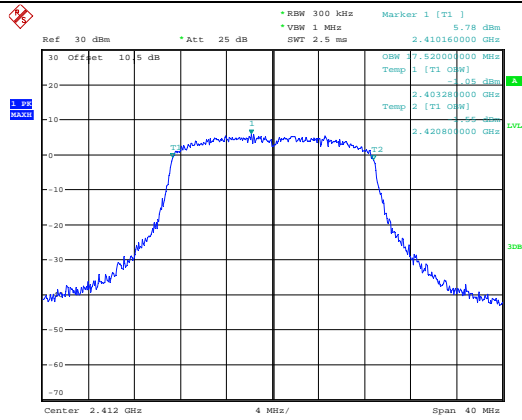

ProjectNo.:CR230952638-RF Tester:Arthur Su  
Date: 13.SEP.2023 20:05:26

802.11n ht20  
Middle Channel

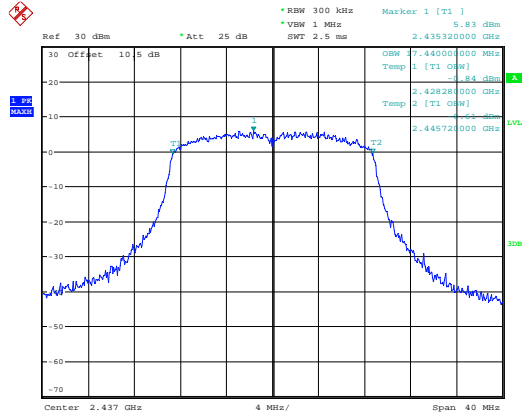

ProjectNo.:CR230952638-RF Tester:Arthur Su  
Date: 13.SEP.2023 20:07:34

802.11n ht20  
Highest Channel

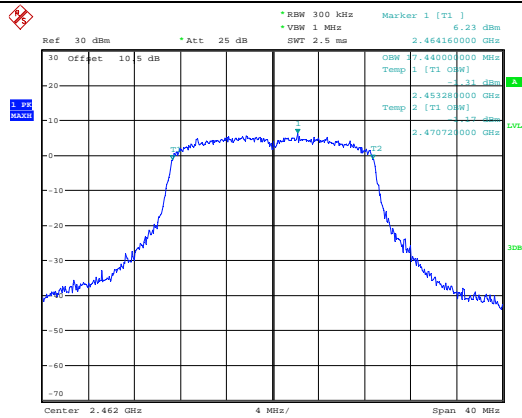

ProjectNo.:CR230952638-RF Tester:Arthur Su  
Date: 13.SEP.2023 20:09:05

**99% Occupied Bandwidth**

802.11n ht40  
Lowest Channel

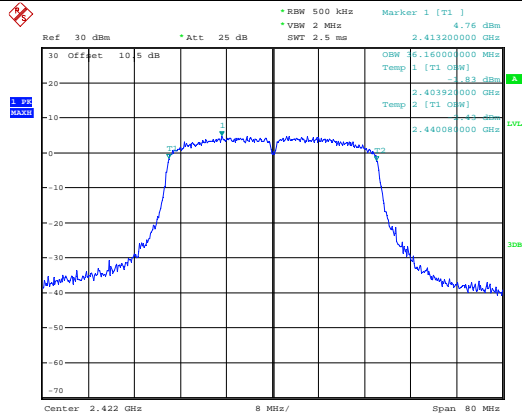

ProjectNo.:CR230952638-RF Tester:Arthur Su  
Date: 13.SEP.2023 20:11:03

802.11n ht40  
Middle Channel

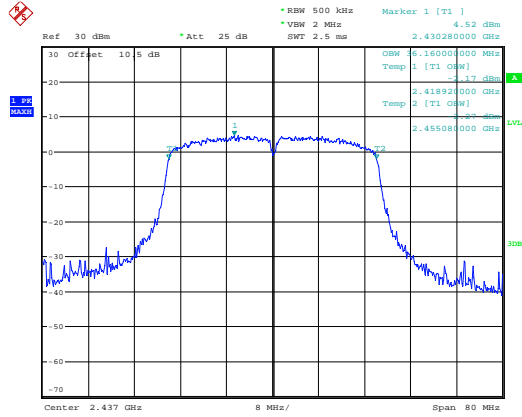

ProjectNo.:CR230952638-RF Tester:Arthur Su  
Date: 13.SEP.2023 20:13:53

802.11n ht40  
Highest Channel

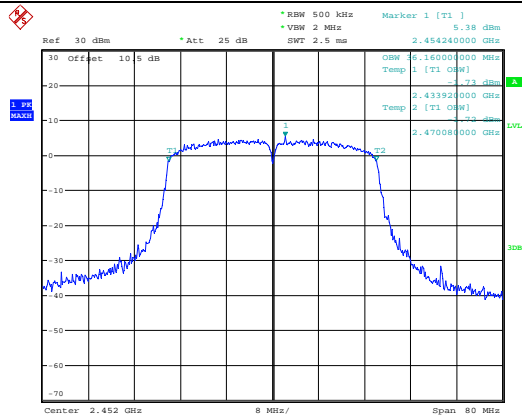

ProjectNo.:CR230952638-RF Tester:Arthur Su  
Date: 13.SEP.2023 20:16:13



**4.5 Maximum Conducted Output Power**

Serial Number:	2B1F-2	Test Date:	2023/9/13
Test Site:	RF	Test Mode:	Transmitting
Tester:	Arthur Su	Test Result:	Pass

**Environmental Conditions:**

Temperature: (°C)	25.9	Relative Humidity: (%)	60	ATM Pressure: (kPa)	100
----------------------	------	---------------------------	----	------------------------	-----

**Test Equipment List and Details:**

Manufacturer	Description	Model	Serial Number	Calibration Date	Calibration Due Date
zhuoxiang	Coaxial Cable	SMA-178	211001	Each time	N/A
eastsheep	Coaxial Attenuator	2W-SMA-JK-18G	21060301	Each time	N/A
Anritsu	Power Meter	ML2495A	1106009	2023/8/4	2024/8/3
Anritsu	Pulse Power Sensor	MA2411A	10780	2023/8/4	2024/8/3

\* Statement of Traceability: China Certification ICT Co., Ltd (Dongguan) attests that all calibrations have been performed, traceable to National Primary Standards and International System of Units (SI).

**Test Data:**

Test Modes	Test Frequency (MHz)	Maximum Conducted Average Output Power (dBm)	Maximum Conducted Peak Output Power (dBm)	Limit (dBm)
802.11b	2412	13.69	16.21	30
	2437	13.75	16.19	30
	2462	13.71	16.12	30
802.11g	2412	11.89	17.52	30
	2437	11.85	17.64	30
	2462	11.84	17.59	30
802.11n ht20	2412	11.68	17.57	30
	2437	11.67	17.68	30
	2462	11.62	17.67	30
802.11n ht40	2422	11.43	17.79	30
	2437	11.41	17.73	30
	2452	11.45	17.81	30

**4.6 Maximum Power Spectral Density**

Serial Number:	2B1F-2	Test Date:	2023/9/13
Test Site:	RF	Test Mode:	Transmitting
Tester:	Arthur Su	Test Result:	Pass

**Environmental Conditions:**

Temperature: (°C)	25.9	Relative Humidity: (%)	60	ATM Pressure: (kPa)	100
----------------------	------	------------------------------	----	------------------------	-----

**Test Equipment List and Details:**

Manufacturer	Description	Model	Serial Number	Calibration Date	Calibration Due Date
R&S	Spectrum Analyzer	FSU26	200256	2023/3/31	2024/3/30
zhuoxiang	Coaxial Cable	SMA-178	211001	Each time	N/A
eastsheep	Coaxial Attenuator	2W-SMA-JK-18G	21060301	Each time	N/A

\* Statement of Traceability: China Certification ICT Co., Ltd (Dongguan) attests that all calibrations have been performed, traceable to National Primary Standards and International System of Units (SI).

**Test Data:**

Test Channel	Test Frequency (MHz)	Power Spectral Density (dBm/3kHz)	Limit (dBm/3kHz)
802.11b	2412	-5.95	8.00
	2437	-6.81	8.00
	2462	-5.36	8.00
802.11g	2412	-11.28	8.00
	2437	-11.27	8.00
	2462	-10.06	8.00
802.11n ht20	2412	-11.64	8.00
	2437	-10.8	8.00
	2462	-11.1	8.00
802.11n ht40	2422	-14.02	8.00
	2437	-13.47	8.00
	2452	-14.25	8.00

Please refer to the below plots:

Maximum power spectral density	
<p>802.11b Lowest Channel</p>	<p>ProjectNo.:CR230952638-RF Tester:Arthur Su Date: 13.SEP.2023 19:55:35</p>
<p>802.11b Middle Channel</p>	<p>ProjectNo.:CR230952638-RF Tester:Arthur Su Date: 13.SEP.2023 19:57:05</p>
<p>802.11b Highest Channel</p>	<p>ProjectNo.:CR230952638-RF Tester:Arthur Su Date: 13.SEP.2023 19:58:31</p>

### Maximum power spectral density

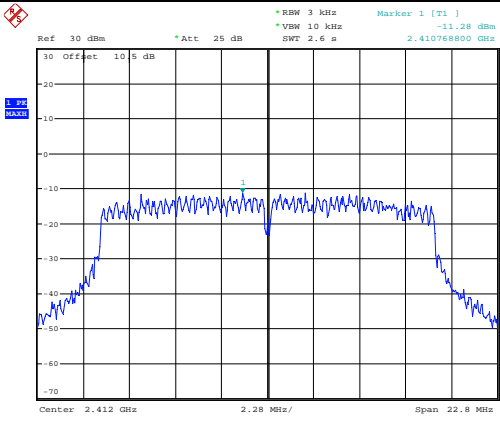
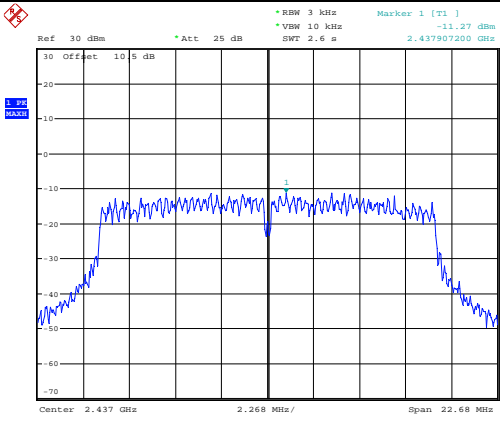
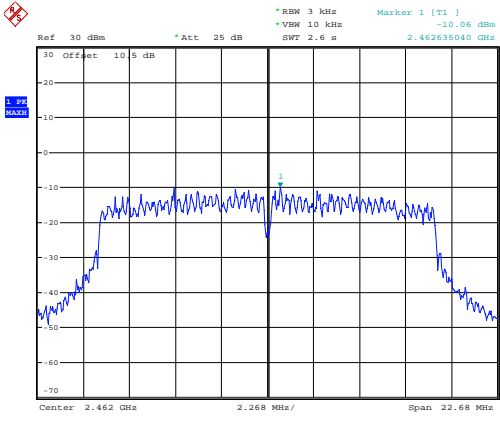
<p>802.11g Lowest Channel</p>	 <p>ProjectNo.:CR230952638-RF Tester:Arthur Su Date: 13.SEP.2023 20:00:43</p>
<p>802.11g Middle Channel</p>	 <p>ProjectNo.:CR230952638-RF Tester:Arthur Su Date: 13.SEP.2023 20:02:23</p>
<p>802.11g Highest Channel</p>	 <p>ProjectNo.:CR230952638-RF Tester:Arthur Su Date: 13.SEP.2023 20:03:57</p>

**Maximum power spectral density**

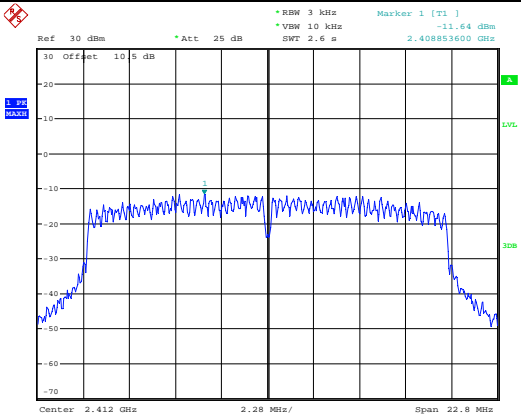
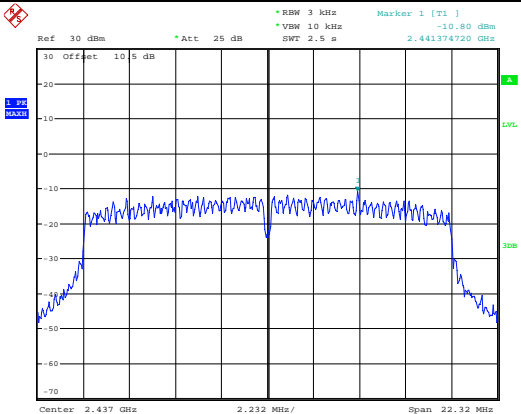
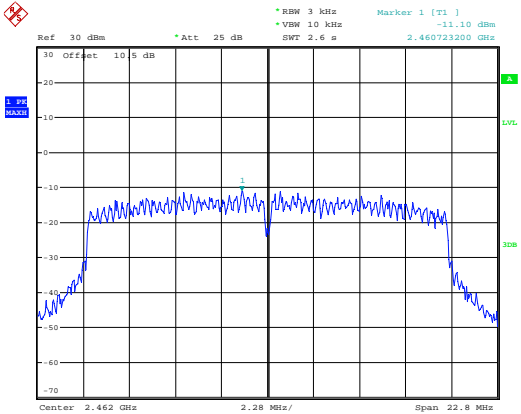
<p>802.11n ht20 Lowest Channel</p>	 <p>ProjectNo.:CR230952638-RF Tester:Arthur Su Date: 13.SEP.2023 20:05:59</p>
<p>802.11n ht20 Middle Channel</p>	 <p>ProjectNo.:CR230952638-RF Tester:Arthur Su Date: 13.SEP.2023 20:08:13</p>
<p>802.11n ht20 Highest Channel</p>	 <p>ProjectNo.:CR230952638-RF Tester:Arthur Su Date: 13.SEP.2023 20:09:40</p>

**Maximum power spectral density**

802.11n ht40  
Lowest Channel

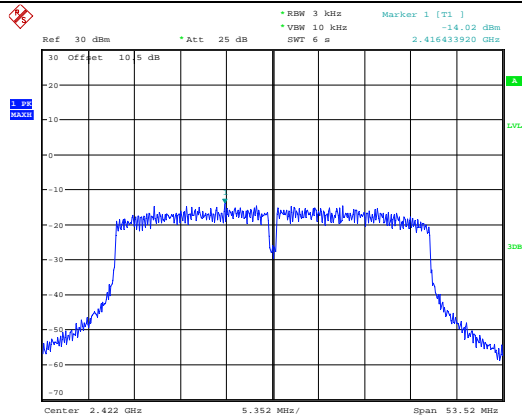

ProjectNo.:CR230952638-RF    Tester:Arthur Su  
 Date: 13.SEP.2023    20:12:39

802.11n ht40  
Middle Channel

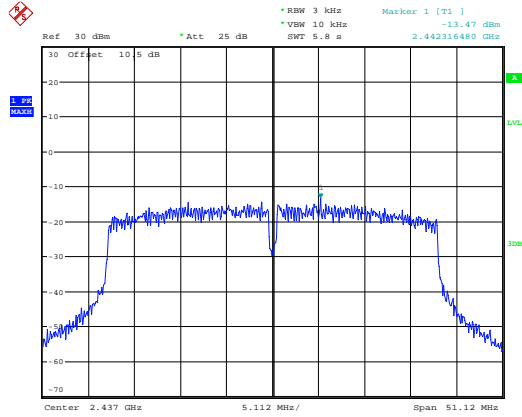

ProjectNo.:CR230952638-RF    Tester:Arthur Su  
 Date: 13.SEP.2023    20:15:02

802.11n ht40  
Highest Channel

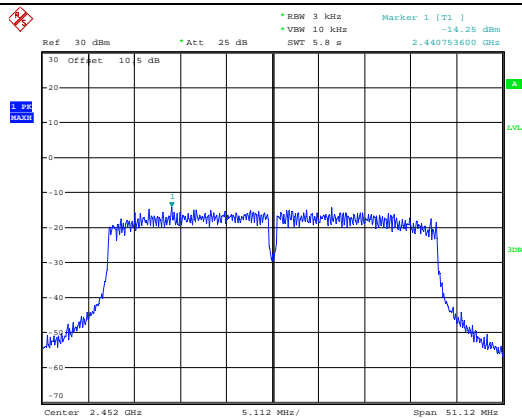

ProjectNo.:CR230952638-RF    Tester:Arthur Su  
 Date: 13.SEP.2023    20:17:20

**4.7 100 kHz Bandwidth of Frequency Band Edge:**

Serial Number:	2B1F-2	Test Date:	2023/9/13
Test Site:	RF	Test Mode:	Transmitting
Tester:	Arthur Su	Test Result:	Pass

**Environmental Conditions:**

Temperature: (°C)	25.9	Relative Humidity: (%)	60	ATM Pressure: (kPa)	100
----------------------	------	---------------------------	----	------------------------	-----

**Test Equipment List and Details:**

Manufacturer	Description	Model	Serial Number	Calibration Date	Calibration Due Date
R&S	Spectrum Analyzer	FSU26	200256	2023/3/31	2024/3/30
zhuoxiang	Coaxial Cable	SMA-178	211001	Each time	N/A
eastsheep	Coaxial Attenuator	2W-SMA-JK-18G	21060301	Each time	N/A

*\* Statement of Traceability: China Certification ICT Co., Ltd (Dongguan) attests that all calibrations have been performed, traceable to National Primary Standards and International System of Units (SI).*

**Test Data:**

*Please refer to the below plots.*

### 100 kHz Bandwidth of Frequency Band Edge

802.11b  
Lowest Band edge

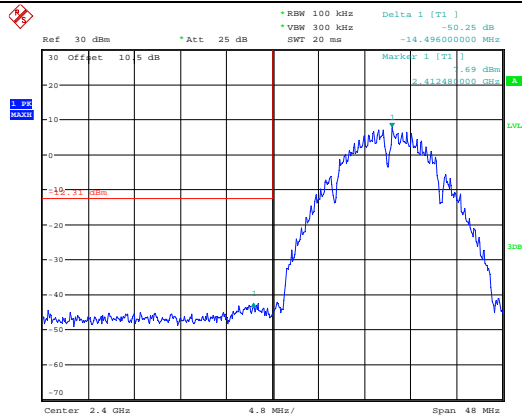

ProjectNo.:CR230952638-RF    Tester:Arthur Su  
 Date: 13.SEP.2023 19:55:53

802.11b  
Highest Band edge

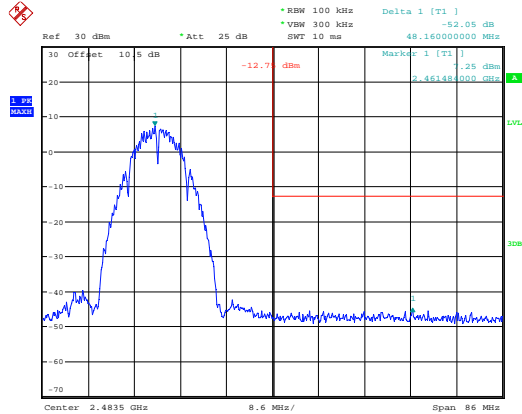

ProjectNo.:CR230952638-RF    Tester:Arthur Su  
 Date: 13.SEP.2023 19:58:46



### 100 kHz Bandwidth of Frequency Band Edge

802.11g  
Lowest Band edge

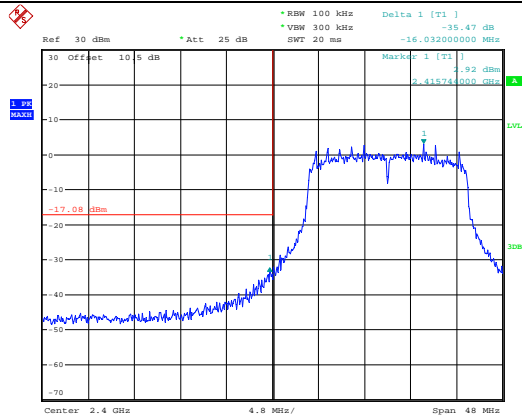

ProjectNo.:CR230952638-RF Tester:Arthur Su  
 Date: 13.SEP.2023 20:00:58

802.11g  
Highest Band edge

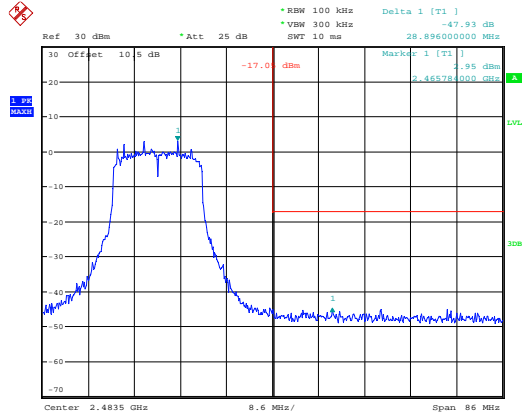

ProjectNo.:CR230952638-RF Tester:Arthur Su  
 Date: 13.SEP.2023 20:04:13

**100 kHz Bandwidth of Frequency Band Edge**

802.11n ht20  
Lowest Band edge

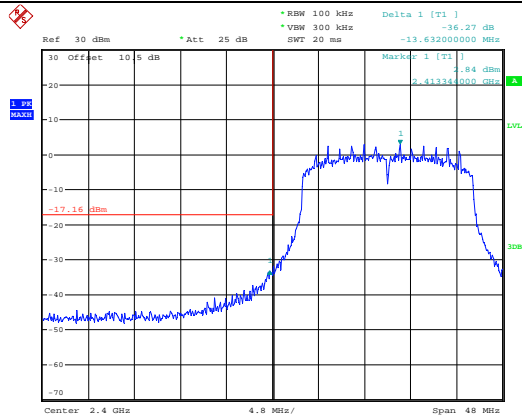

ProjectNo.:CR230952638-RF Tester:Arthur Su  
 Date: 13.SEP.2023 20:06:19

802.11n ht20  
Highest Band edge

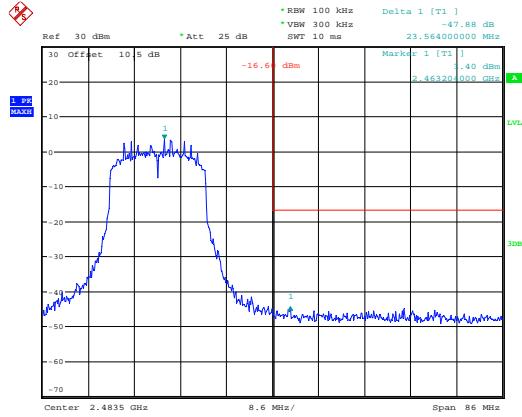

ProjectNo.:CR230952638-RF Tester:Arthur Su  
 Date: 13.SEP.2023 20:10:01

### 100 kHz Bandwidth of Frequency Band Edge

802.11n ht40  
Lowest Band edge

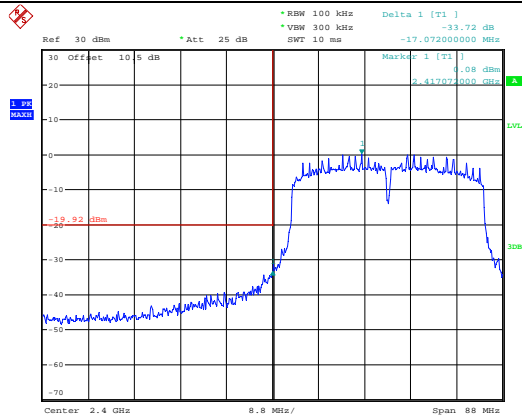

ProjectNo.:CR230952638-RF    Tester:Arthur Su  
 Date: 13.SEP.2023 20:13:00

802.11n ht40  
Highest Band edge

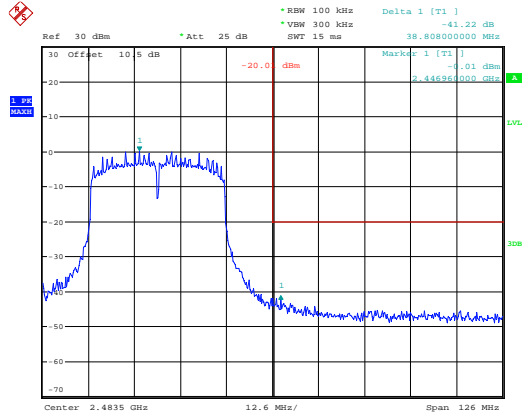

ProjectNo.:CR230952638-RF    Tester:Arthur Su  
 Date: 13.SEP.2023 20:17:42

**4.8 Duty Cycle:**

Serial Number:	2B1F-2	Test Date:	2023/9/13
Test Site:	RF	Test Mode:	Transmitting
Tester:	Arthur Su	Test Result:	N/A

Environmental Conditions:					
Temperature: (°C)	25.9	Relative Humidity: (%)	60	ATM Pressure: (kPa)	100

**Test Equipment List and Details:**

Manufacturer	Description	Model	Serial Number	Calibration Date	Calibration Due Date
R&S	Spectrum Analyzer	FSU26	200256	2023/3/31	2024/3/30
zhuoxiang	Coaxial Cable	SMA-178	211001	Each time	N/A
eastsheep	Coaxial Attenuator	2W-SMA-JK-18G	21060301	Each time	N/A

\* Statement of Traceability: China Certification ICT Co., Ltd (Dongguan) attests that all calibrations have been performed, traceable to National Primary Standards and International System of Units (SI).

**Test Data:**

Test Modes	Ton (ms)	Ton+off (ms)	Duty cycle (%)	1/T (Hz)	VBW Setting (kHz)
802.11b	100	100	100.00	10	0.01
802.11g	2.063	2.153	95.82	485	1
802.11n ht20	1.917	1.985	96.57	522	1
802.11n ht40	0.944	1.033	91.38	1059	2

Please refer to the below plots:

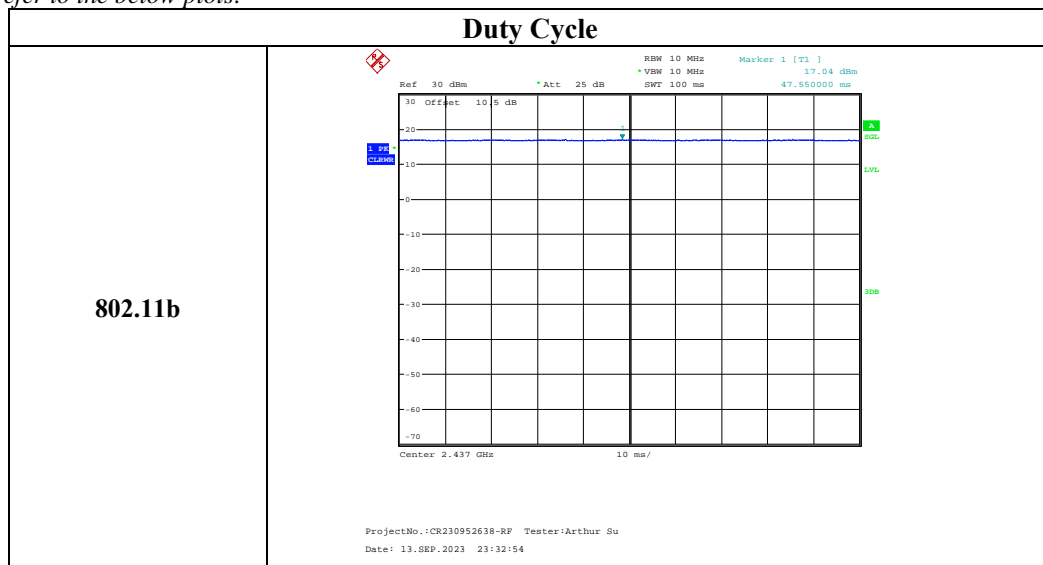

802.11g

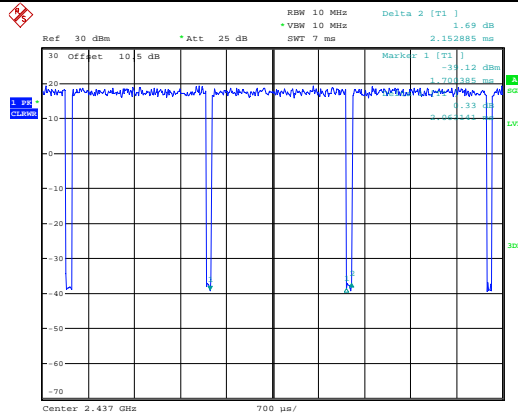

## **5. EUT PHOTOGRAPHS**

---

Please refer to the attachment CR230952638-EXP EUT EXTERNAL PHOTOGRAPHS and CR230952638-INP EUT INTERNAL PHOTOGRAPHS

## **6. TEST SETUP PHOTOGRAPHS**

---

Please refer to the attachment CR230952638-00C-TSP TEST SETUP PHOTOGRAPHS.

**===== END OF REPORT =====**