

Antenna specification

Antenna Sample Confirmation From

Name of supplier	ShenZhen Aihui Technology Co. , Ltd				
Customer name	Ji mo ke				
Sample name	K1-K2-K3				
model	FPC				
Sample size	The main antenna (0.81) is black with a line length of 100mm. (4 generation terminal) The secondary antenna (0.81) is gray with a length of 136mm. (4 generation terminal)				
Inspection item	Performance test	Visual inspection	Structure	In the news	Test results
Notes					
Quality Audit		Project Audit		Business confirmation	
The following is to be completed by the client					

Customer feedback	
Customer signature/seal	 date:

Antenna Test Report

Test Unit: Shenzhen Aihui Technology Co. , Ltd.			
Materials	FPC		
Antenna form	PIFA	Polarization mode	Linear
Application scenario	2400Mhz-2500Mhz 5100Mhz-5850Mhz		
Working band	2400Mhz-2500Mhz 5100Mhz-5850Mhz	VSWR	≤2

Shenzhen Aihui Technology Co. , Ltd.

Power	Max: 2W	Impedance	50Ω
dBi	≥2dBi		
Test Equipment	HPE5071C、Shielding Room、3D automatic turntable		
<p>Antenna Description::</p> <p>1. Grounding processing and picture description: no</p> <p>2. Need to change the motherboard to match: no</p> <ul style="list-style-type: none">● Test voltage: 3.6V, check the antenna contact is good before testing.● The RF cable of the integrated tester is kept in a natural state and can not be curled. <p>Specification:test the specified power level, all indicators must conform to the specifications.</p>			

1. Project Image

2. Test Fixture

3. Antenna matching circuit

4. S11 test

5. Antenna passive efficiency and gain

6. Darkroom test equipment and data

7. Schematic diagram of antenna assembly

8. Antenna environment handling

9. Antenna mass production index

10. Structural drawing

1. Project Image

The final verification antenna performance prototype in our company for at least one year, easy to analyze and solve the problem of antenna mass production, to ensure the quality of antenna shipment

2. Test Fixture

Objective: to test the passive parameters of antenna as accurately as possible. Making

Method: the handset is made of a 50 ohm coaxial cable, one end of which is connected to the test point of the back end of the matching circuit of the handset motherboard (front end of the RF test hole) , and the other end is connected to the SMA joint. The diagram is as follows:

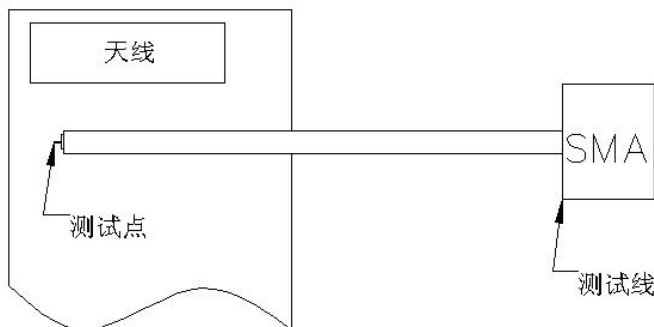

3. Antenna matching circuit

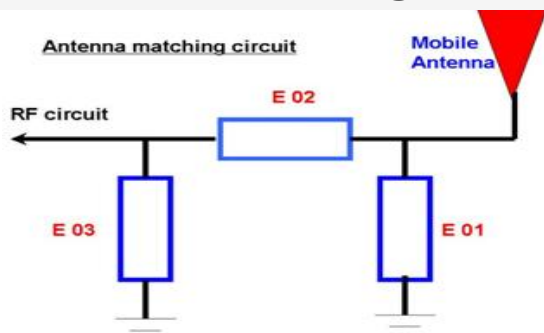

Modify

E01	E02	E03
No	No	No

Note: The match is unmodified.

4.S11 test

4.0 4.0s11 test method description of test equipment: Network Analyzer (E5071C) test method: a 50 ohm CABLE is used to export from the instrument test port. The SMA connector for connecting the handset is calibrated using a calibration piece, record the echo loss and standing wave ratio corresponding to the relevant frequency points. The test schematic is as follows:

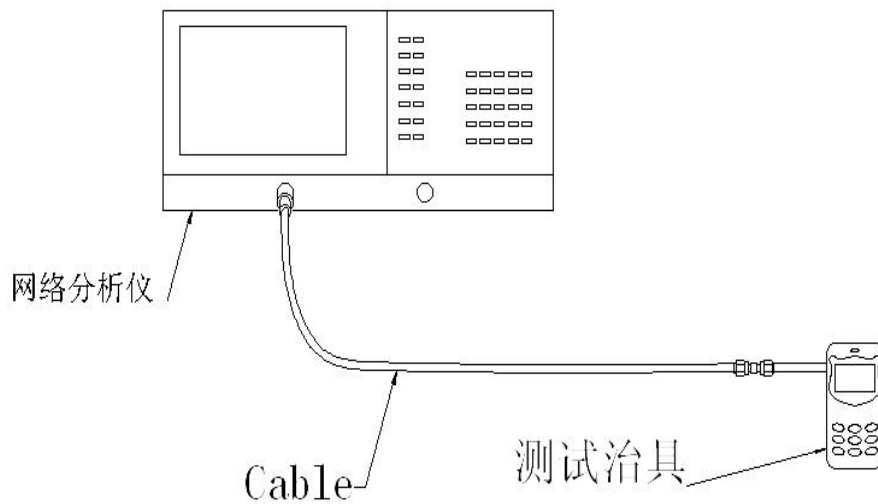

4.1 SWR

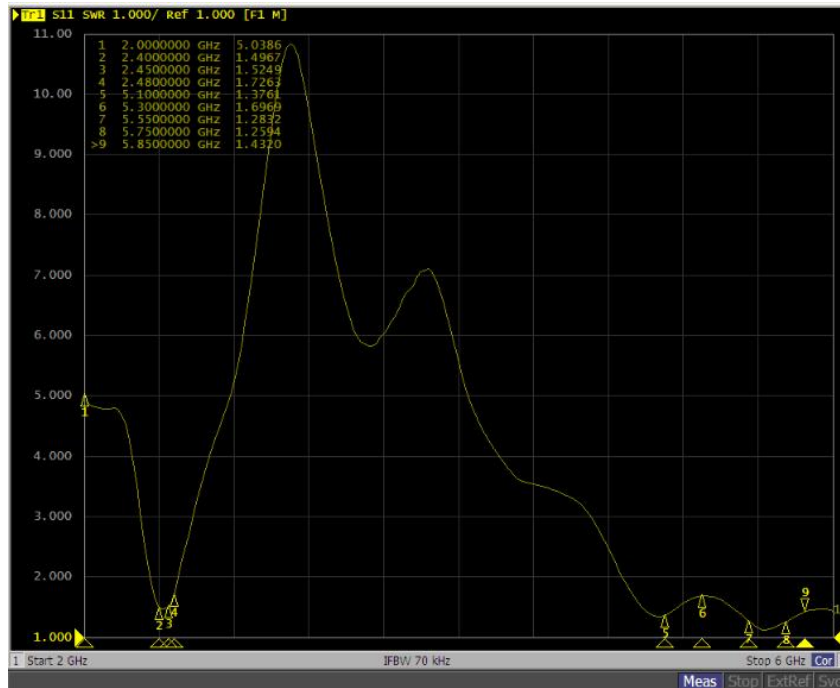

5. Test Equipment

Test system: shielded darkroom

The temperature was $22^{\circ}\text{C} \pm 3^{\circ}\text{C}$ and the humidity was $50\% \pm 15\%$

Test equipment: when testing passive data, use the Network analyzer AGILENTE5071C to test active data, use the omnibus CMW500

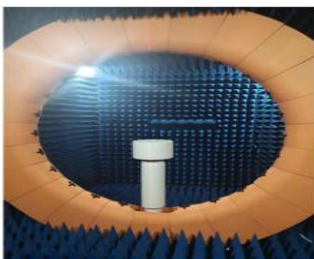

nce and
Shenzhen

6.Active antenna test data

Frequency Band	2.4GWIFI-B 模			5GWIFI-A 模		
channel	L	M	H	L	M	H
TRP	11.8	12.5	12.3	11.4	11.5	11.3
TIS			-70.5			-69.1
Frequency Band	2.4WIFI-G 模			2.4WIFI-N 模		
channel	L	M	H	L	M	H
TRP	11.4	10.8	11.3	10.5	10.3	10.4
TIS			-67.5			-66.3

Freq(MHz)	Efficiency (%)	Gain (dBi)
2400	55.4	1.14
2410	54.2	1.06
2420	53.9	0.58

Shenzhen Aihui Technology Co. , Ltd.

2430	57.1	1.11
2440	56.3	1.30
2450	55.4	1.25
2460	50.8	1.30
2470	51.4	1.05
2480	50.6	0.98

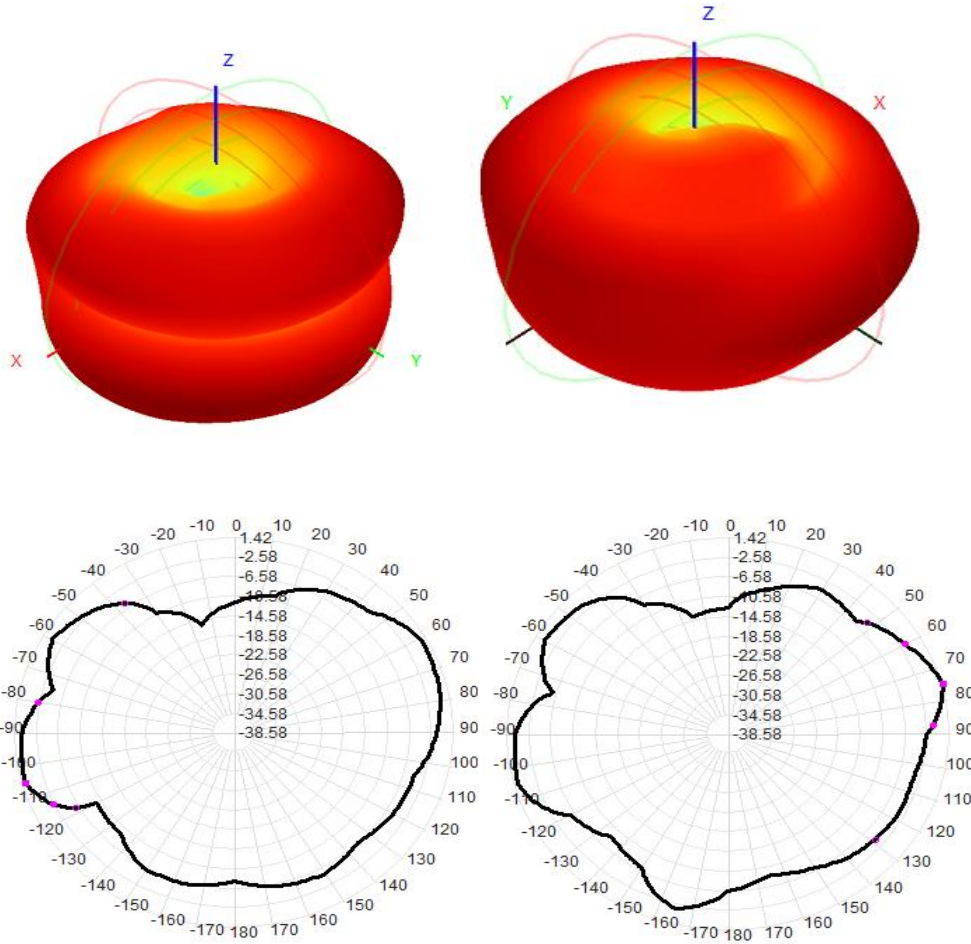

Address: 402TEL: 0755-23203435fax: 0755-23203435, Block C, Juxin Science and Technology Industrial Park, Nanchang community, xixiang, Baoan District, Shenzhen

Shenzhen Aihui Technology Co. , Ltd.

Freq(MHz)	Efficiency (%)	Gain (dBi)
5000	52.4	1.07
5100	50.6	1.25
5200	54.3	1.30
5300	51.9	1.08
5400	52.3	1.55
5500	50.9	1.42
5600	49.6	1.30
5700	48.7	1.26
5800	49.3	1.08

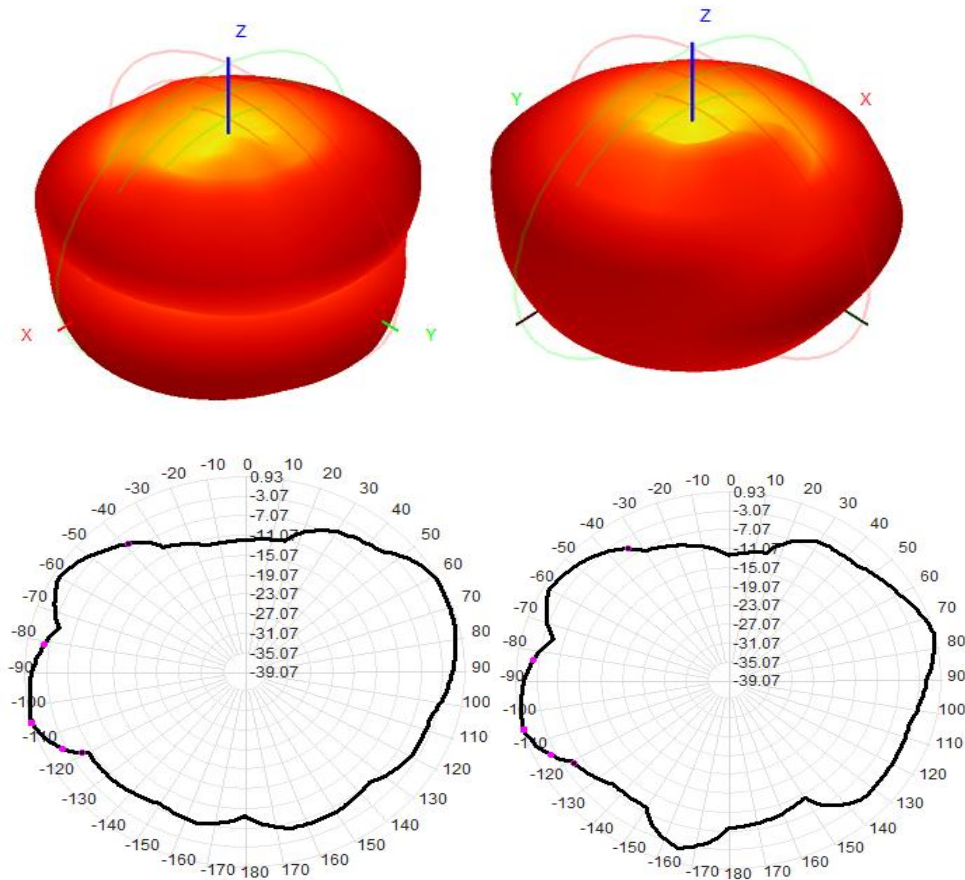

7. Antenna environment handling

The original environment, we do not do processing

8. Antenna mass production index

When the antenna is mass-produced, the standing wave ratio is taken as the mass-produced test standard.

Based on the differences of the project itself, the following criteria are given:

Frequency	Standard for volume production
2400 MHZ -2500MHZ 5100 MHZ-5850 MHZ	VSWR (Mass Production performance) & LT; VSWR(recognition performance) 0.5
1575 MHZ -5800MHZ	VSWR (Mass Production performance) & LT; VSWR(recognition performance) 0.5

10. Structural drawings

Shenzhen Aihui Technology Co. , Ltd.

