

# FCC PART 15 SUBPART C

Magnetic Wireless Car Charger Holder

Model No.: MG1 Pro

FCC ID: 2AXTH-MG1PRO

Report No.: NCT24008083-1

Issue Date: 2024-01-25

*Prepared for*

Shenzhen Caibo Technology Co., Ltd.

F4, Building 30, Fifth Industrial Zone, Huaide Cuigang Industrial Park, Fu Yong,  
Bao'an District, Shenzhen, China

*Prepared by*

Shenzhen NCT Testing Technology Co., Ltd.

A101&2F B2, Fuqiao 6th Area, Xintian Community, Fuhai Street, Baoan District,  
Shenzhen, People's Republic of China

TEL: 400-8868-419

FAX: 86-755-27790922

**TABLE OF CONTENT**

<b>Test Report Description</b>	<b>Page</b>
<b>1. SUMMARY OF TEST RESULTS</b> .....	<b>5</b>
<b>2. GENERAL INFORMATION</b> .....	<b>6</b>
2.1. Description of Device (EUT) .....	6
2.2. Description of Support Units .....	6
2.3. Independent Operation Modes .....	7
2.4. Description of Test Facility .....	7
2.5. Measurement Uncertainty .....	8
<b>3. MEASURING DEVICE AND TEST EQUIPMENT</b> .....	<b>9</b>
<b>4. 20DB BANDWIDTH</b> .....	<b>11</b>
4.1. Test Procedure .....	11
4.2. Test Results .....	11
<b>POWER LINE CONDUCTED EMISSION MEASUREMENT</b> .....	<b>12</b>
4.3. Block Diagram of Test Setup .....	12
4.4. Limits .....	12
4.5. Test Procedure .....	12
4.6. Measuring Results .....	13
<b>5. RADIATED EMISSION TEST</b> .....	<b>16</b>
5.1. Measurement Procedure .....	16
5.2. Test SET-UP (Block Diagram of Configuration) .....	16
5.3. Radiated Emission Limit .....	17
5.4. Measurement Result .....	19
<b>7. TEST PHOTOGRAPHS AND EUT PHOTOGRAPHS</b> .....	<b>23</b>

## TEST REPORT DESCRIPTION

Applicant : Shenzhen Caibo Technology Co., Ltd.  
Address : F4, Building 30, Fifth Industrial Zone, Huaide Cuigang Industrial Park, Fu Yong, Bao'an District, Shenzhen, China  
Manufacturer : Shenzhen Caibo Technology Co., Ltd.  
Address : F4, Building 30, Fifth Industrial Zone, Huaide Cuigang Industrial Park, Fu Yong, Bao'an District, Shenzhen, China  
Factory: Shenzhen Caibo Technology Co., Ltd.  
Address: F4, Building 30, Fifth Industrial Zone, Huaide Cuigang Industrial Park, Fu Yong, Bao'an District, Shenzhen, China  
EUT : Magnetic Wireless Car Charger Holder  
Model Name : MG1 Pro  
Trademark : KOAKUMA

Measurement Procedure Used:

APPLICABLE STANDARDS	
STANDARD	TEST RESULT
FCC 47 CFR Part 15, Subpart C	PASS

The above equipment was tested by Shenzhen NCT Testing Technology Co., Ltd. The test data, data evaluation, test procedures, and equipment configurations shown in this report were made in accordance with the procedures given in ANSI C63.10 (2013) and the energy emitted by the sample EUT tested as described in this report is in compliance with conducted and radiated emission limits of FCC Rules Part 15C

The test results of this report relate only to the tested sample identified in this report.

Test Engineer:

*Keven Wu*

Keven Wu / Engineer

Technical Manager:

*Henry Wang*

Henry Wang / Manager



**Modified Information**

Version	Report No.	Revision Data	Summary

**1. SUMMARY OF TEST RESULTS**

Test Item	Section in CFR 47	Result
Antenna requirement	15.203	Pass
AC Power Line Conducted Emission	15.207	Pass
Spurious Emission	15.209(a)(f)	Pass
20dB Bandwidth	15.215	Pass

## 2. GENERAL INFORMATION

### 2.1. Description of Device (EUT)

EUT	:	Wireless Charger
Model Number	:	MG1 Pro
Serial Number	:	N/A
Mode difference	:	N/A
Power Rating	:	Input: DC 5V/2A, 9V/2A Wireless Output: 5W,7.5W,10W,15W
Operation Frequency for WPT	:	115-205KHz
Modulation	:	ASK
Antenna Type:	:	Coil Antenna
Date of Received	:	2024-01-15
Date of Test	:	2024-01-15 to 2024-01-19

### 2.2. Description of Support Units

The EUT has been tested as an independent unit together with other necessary accessories or support units. The following support units or accessories were used to form a representative test configuration during the tests.

Item	Equipment	Mfr/Brand	Model/Type No.	Series No.	Note
E-1	wireless charging load	YBZ	HW-200200ZP1	N/A	Auxiliary
E-2	HUAWEI QUICK CHARGE	HUAWEI	HW-200200ZP1	JN67LSN7N0 3451	Auxiliary

- Note:
- (1)The support equipment was authorized by Declaration of Confirmation.
  - (2)For detachable type I/O cable should be specified the length in cm in 『Length』 column.

### 2.3. Independent Operation Modes

No.	Emission test modes
Mode1	Wireless Output(5W)
Mode2	Wireless Output(7.5W)
Mode3	Wireless Output(10W)
Mode4	Wireless Output(15W)
Mode5	Stand by

**Note:** All modes have been tested, only the data reflecting the worst test mode is included in the report.

### 2.4. Description of Test Facility

#### Site Description

EMC Lab. : Accredited by CNAS, 2022-09-27  
The certificate is valid until 2028.01.07  
The Laboratory has been assessed and proved to be in compliance with  
CNAS-CL01:2006 (identical to ISO/IEC 17025:2017)  
The Certificate Registration Number is L8251

Designation Number: CN1347  
Test Firm Registration Number: 894804  
Accredited by A2LA, June 14, 2023  
The Certificate Registration Number is 6837.01

Accredited by Industry Canada, November 09, 2018  
The Conformity Assessment Body Identifier is CN0150  
Company Number: 30806

Name of Firm : Shenzhen NCT Testing Technology Co., Ltd.  
Site Location : A101&2F B2, Fuqiao 6th Area, Xintian Community, Fuhai Street, Baoan District, Shenzhen, People's Republic of China

## 2.5. Measurement Uncertainty

Parameter	Uncertainty
RF output power, conducted	±1.0dB
Power Spectral Density, conducted	±2.2dB
Radio Frequency	± 1 x 10 <sup>-6</sup>
Bandwidth	± 1.5 x 10 <sup>-6</sup>
Time	±2%
Duty Cycle	±2%
Temperature	±1°C
Humidity	±5%
DC and low frequency voltages	±3%
Conducted Emissions (150kHz~30MHz)	±3.24dB
Radiated Emission(30MHz~1GHz)	±5.03dB
Radiated Emission(1GHz~25GHz)	±4.74dB
Radiated spurious emissions (9kHz~30MHz)	±4.3dB



### 3. MEASURING DEVICE AND TEST EQUIPMENT

#### Radiated emission & Radio Frequency Test Equipment

Name	Model No.	Serial No.	Manufacturer	Date of Cal.	Due Date
966 Shielded Room	966 Room	/	EMToni	2022/5/31	2025/5/30
EMI Test Receiver	ESCI	101178	Rohde & Schwarz	2023/6/21	2024/6/20
Spectrum Analyze (10Hz-26.5GHz)	N9020A	MY50510202	Agilent	2023/6/21	2024/6/20
Amplifi (30MHz-1GHz)	BBV 9743 B	00374	SCHNARZBECK	2023/6/21	2024/6/20
Bilog Antenna (30MHz-1GHz)	VULB9162	00473	SCHNARZBECK	2023/3/19	2025/3/18
Horn antenna (1GHz-18GHz)	BBHA 9120 D	02622	SCHNARZBECK	2023/3/19	2025/3/18
Pream plifier (1GHz-18GHz)	BBV 9718D	0024	SCHNARZBECK	2023/6/21	2024/6/20
Spectrum Analyze (10Hz-40GHz)	FSV 40	100952	Rohde & Schwarz	2023/6/21	2024/6/20
Pream plifier (18GHz-40GHz)	BBV 9721	0056	SCHNARZBECK	2023/6/21	2024/6/20
Double Ridge Guide Horn Antenna (18GHz-40GHz)	SAS-574	588	A.H.System	2023/3/19	2025/3/18
Loop Antenna (9KHz-30MHz)	FMZB1519B	014	SCHNARZBECK	2023/6/21	2024/6/20
Amplifier (9KHz-30MHz)	CVP 9222 C	00109	SCHNARZBECK	2023/6/21	2024/6/20
MXG Signal Analyzer	N9020A	101178	Agilent	2023/6/21	2024/6/20
MXG Vector Signal Generator	N5182A	MY50510202	Agilent	2023/6/21	2024/6/20
MXG Analog Signal Generator	N5181A	00374	Agilent	2023/6/21	2024/6/20
Power Sensor	TR1029-2	00473	Techoy	2023/6/21	2024/6/20
RF Swith	TR1029-1	02622	Techoy	2023/6/21	2024/6/20
Cable	DA800- 4000MM	NA	DA	2023/6/21	2024/6/20
Cable	DA800- 11000MM	NA	DA	2023/6/21	2024/6/20

## Conducted emission Test Equipment

Name	Model No.	Serial No.	Manufacturer	Date of Cal.	Due Date
944 Shielded Room	944 Room	/	EMToni	2022/5/31	2025/5/30
EMI Test Receiver	ESPI	101604	Rohde & Schwarz	2023/6/21	2024/6/20
LISN	ENV 216	102796	Rohde & Schwarz	2023/6/21	2024/6/20
LISN	VN1-13S	004023	CRANAGE	2023/6/21	2024/6/20
Cable	RG223-1500MM	NA	RG	2023/6/21	2024/6/20

## Other

Item	Name	Manufacturer	Model	Software version
1	EMC Conduction Test System	AUDIX	e3	6.120718
2	EMC radiation test system	AUDIX	e3	6.120718
3	RF test system	TACHOY	RFTest	V1.0.0
4	RF communication test system	TACHOY	RFTest	V1.0.0

## 4. 20DB BANDWIDTH

### 4.1. Test Procedure

Set to the maximum power setting and enable the EUT transmit continuously  
 Set RBW = 300Hz.  
 Set the video bandwidth (VBW) =1KHz.  
 Set Span= 5KHz  
 Set Detector = Peak.  
 Set Trace mode = max hold.  
 Set Sweep = auto couple.  
 Measure and record the results in the test report.

### 4.2. Test Results

All of the listed pre-test mode were tested, only the data of the worst mode (Mode4) is recorded in the report

	Frequency (KHz)	20dB bandwidth (Hz)	99% bandwidth (Hz)	Result
For Phone	144.555	754	643	Pass

For Phone

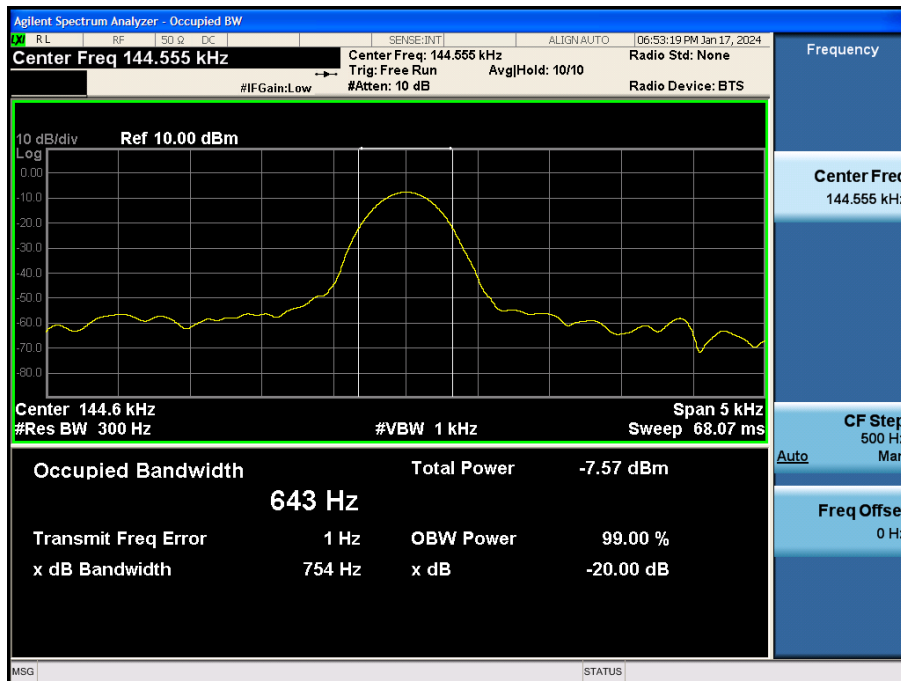

## POWER LINE CONDUCTED EMISSION MEASUREMENT

### 4.3. Block Diagram of Test Setup

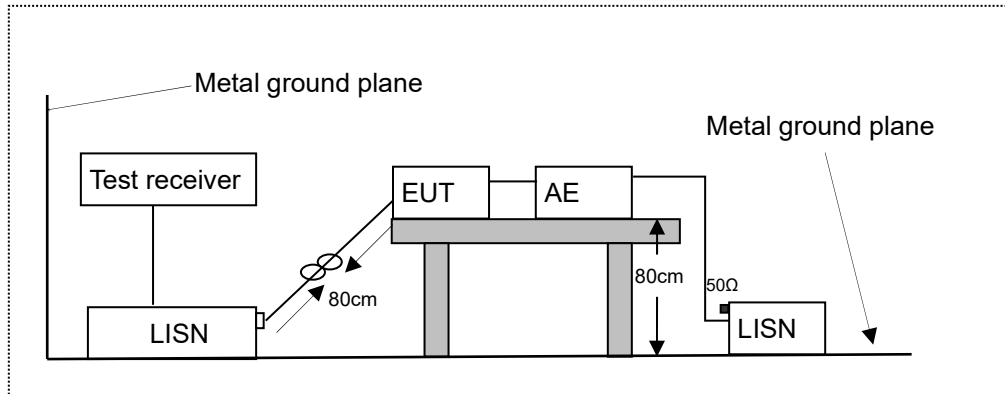

LISN: Line Impedance Stabilization Network  
 AE: Associated equipment  
 EUT: Equipment under test

### 4.4. Limits

FCC Part 15.207

Frequency (MHz)	Limit (dB $\mu$ V)	
	Quasi-peak Level	Average Level
0.15 ~ 0.50	66.0 ~ 56.0 *	56.0 ~ 46.0 *
0.50 ~ 5.00	56.0	46.0
5.00 ~ 30.00	60.0	50.0

NOTE1-The lower limit shall apply at the transition frequencies.  
 NOTE2-The limit decreases linearly with the logarithm of the frequency in the range 0.15MHz to 0.50MHz.

### 4.5. Test Procedure

The EUT was placed on a desk 0.8 m height from the metal ground plane and 0.4 m from the conducting wall of the shielding room and it was kept at least 0.8 m from any other grounded conducting surface. The size of the table will nominally be 1.5 m x1.0 m.

The rear of the arrangement shall be flush with the back of the supporting tabletop unless that would not be possible or typical of normal use.

All units of equipment forming the system under test (includes the EUT as well as connected peripherals and associated equipment or devices) shall be arranged such that a nominal 0.1 m separation is achieved between the neighboring units.

Connect EUT to the power mains through a line impedance stabilization network (LISN). Where the mains cable supplied by the manufacturer is longer than 1 m, the excess should be folded at the centre into a bundle no longer than 0.4 m, so that its length is shortened to 1 m.

All the support units are connecting to the other LISN.

The LISN provides 50 ohm coupling impedance for the measuring instrument.

Both sides of AC line were checked for maximum conducted interference.

The frequency range from 150 kHz to 30 MHz was sweep.

Set the test-receiver system to quasi peak detect function and average detect function, and to measure the conducted emissions values.

Test results were obtained from the following equation:

Emission Level (dB $\mu$ V) = LISN Factor (dB) + Cable Loss (dB) + Reading (dB $\mu$ V)

Margin (dB) = Emission Level (dB $\mu$ V) - Limit (dB $\mu$ V)

#### 4.6. Measuring Results

**PASS.**

Temperature:	26°C	Relative Humidity:	41%
Pressure:	101kPa	Phase :	L
Test Voltage :	AC 120V/60Hz	Mode:	Mode 1

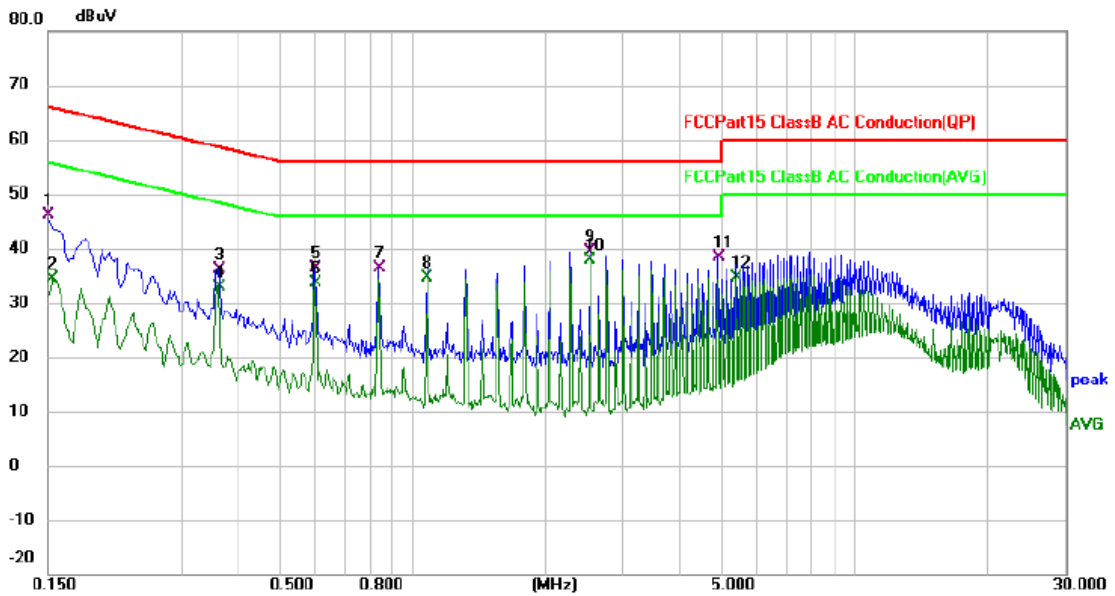

No.	Mk.	Freq. MHz	Reading Level dBuV	Correct Factor dB	Measure- ment dBuV	Limit dBuV	Over dB	Detector	Comment
1		0.1500	35.17	11.04	46.21	66.00	-19.79	QP	
2		0.1539	23.29	11.04	34.33	55.79	-21.46	AVG	
3		0.3620	25.40	10.72	36.12	58.68	-22.56	QP	
4		0.3620	22.14	10.72	32.86	48.68	-15.82	AVG	
5		0.6020	25.64	10.72	36.36	56.00	-19.64	QP	
6		0.6020	22.80	10.72	33.52	46.00	-12.48	AVG	
7		0.8420	25.68	10.74	36.42	56.00	-19.58	QP	
8		1.0820	23.97	10.74	34.71	46.00	-11.29	AVG	
9		2.5220	28.69	10.79	39.48	56.00	-16.52	QP	
10	*	2.5220	27.19	10.79	37.98	46.00	-8.02	AVG	
11		4.9060	27.40	10.86	38.26	56.00	-17.74	QP	
12		5.3819	23.61	11.07	34.68	50.00	-15.32	AVG	

**Notes:**

1. An initial pre-scan was performed on the line and neutral lines with peak detector.
2. Quasi-Peak and Average measurement were performed at the frequencies with maximized peak emission.
3. Measurement Level = Reading level + Correct Factor

Temperature:	26°C	Relative Humidity:	41%
Pressure:	101kPa	Phase :	N
Test Voltage :	AC 120V/60Hz	Mode:	Mode 1

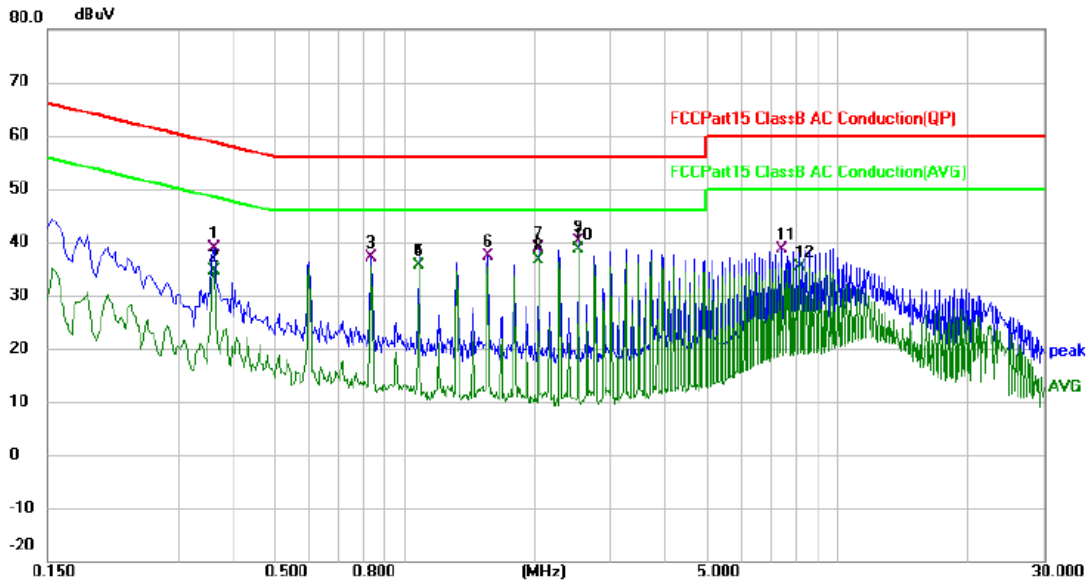

No. Mk.	Freq. MHz	Reading Level dBuV	Correct Factor dB	Measurement dBuV	Limit dBuV	Over dB	Detector	Comment
1	0.3620	28.06	10.74	38.80	58.68	-19.88	QP	
2	0.3620	23.77	10.74	34.51	48.68	-14.17	AVG	
3	0.8420	26.31	10.76	37.07	56.00	-18.93	QP	
4	1.0820	24.77	10.76	35.53	46.00	-10.47	AVG	
5	1.0820	24.77	10.76	35.53	46.00	-10.47	AVG	
6	1.5620	26.70	10.78	37.48	56.00	-18.52	QP	
7	2.0420	28.15	10.78	38.93	56.00	-17.07	QP	
8	2.0420	25.97	10.78	36.75	46.00	-9.25	AVG	
9	2.5220	29.21	10.80	40.01	56.00	-15.99	QP	
10 *	2.5220	27.79	10.80	38.59	46.00	-7.41	AVG	
11	7.4460	27.54	11.01	38.55	60.00	-21.45	QP	
12	8.1660	24.32	11.05	35.37	50.00	-14.63	AVG	

**Notes:**

1. An initial pre-scan was performed on the line and neutral lines with peak detector.
2. Quasi-Peak and Average measurement were performed at the frequencies with maximized peak emission.
3. Measurement Level = Reading level + Correct Factor

## 5. RADIATED EMISSION TEST

### 5.1. Measurement Procedure

1. The EUT was placed on a turn table which is 0.8m above ground plane.
2. Maximum procedure was performed on the six highest emissions to ensure EUT compliance.
3. And also, each emission was to be maximized by changing the polarization of receiving antenna both horizontal and vertical.
4. Repeat above procedures until all frequency measured were complete.
5. Use the following receiver/spectrum analyzer settings:  
Span = wide enough to fully capture the emission being measured  
RBW=200Hz for 9KHz to 150KHz,  
RBW=9kHz for 150KHz to 30MHz,  
RBW=120KHz for 30MHz to 1GHz  
VBW  $\geq$  3\*RBW  
Sweep = auto  
Detector function = QP  
Trace = max hold

### 5.2. Test SET-UP (Block Diagram of Configuration)

(A) Radiated Emission Test Set-Up, Frequency Below 30MHz

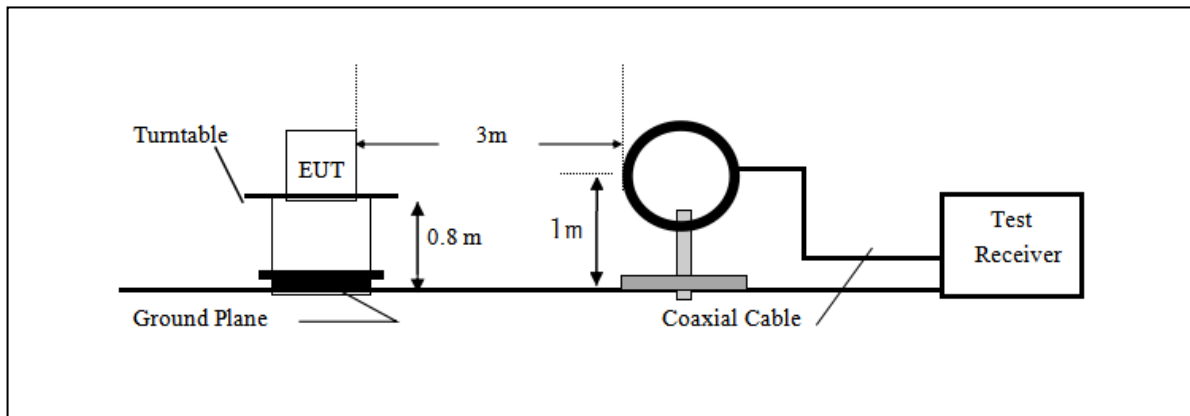



(B) Radiated Emission Test Set-Up, Frequency Below 1000MHz

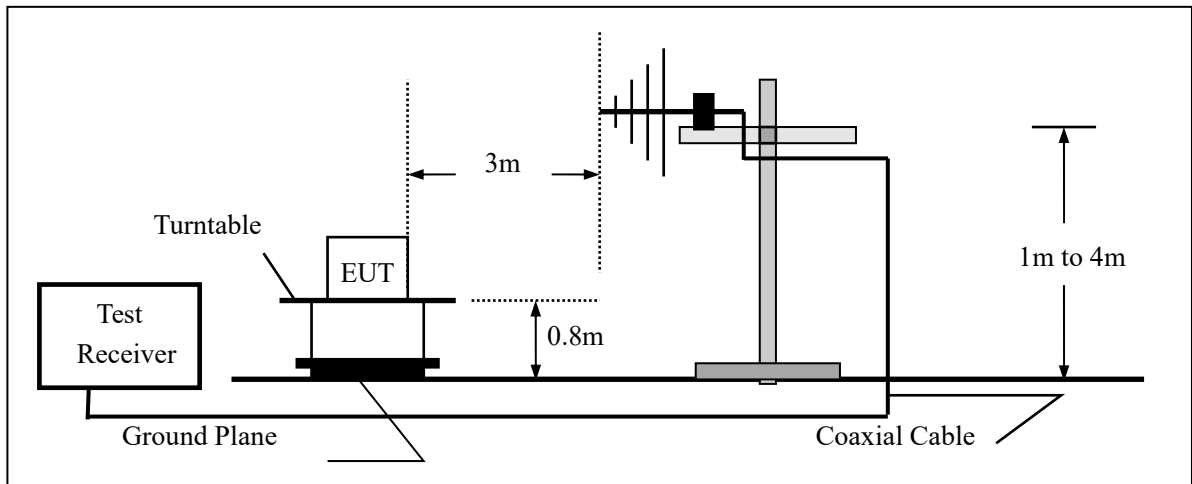

**5.3. Radiated Emission Limit**

The emissions from an intentional radiator shall not exceed the field strength levels specified in the following table 15.209(a):

FCC Part 15.209				
Frequency (MHz)	Field Strength Limitation		Field Strength Limitation Frequency tion at 3m Measurement Dist	
	(uV/m)	Dist	(uV/m)	(dBuV/m)
0.009 – 0.490	$2400 / F(\text{KHz})$	300m	$10000 * 2400/F(\text{KHz})$	$20\log 2400/F(\text{KHz}) + 80$
0.490 – 1.705	$24000 / F(\text{KHz})$	30m	$100 * 24000/F(\text{KHz})$	$20\log 24000/F(\text{KHz}) + 40$
1.705 – 30.00	30	30m	$100 * 30$	$20\log 30 + 40$
30.0 – 88.0	100	3m	100	$20\log 100$
88.0 – 216.0	150	3m	150	$20\log 150$
216.0 – 960.0	200	3m	200	$20\log 200$
Above 960.0	500	3m	500	$20\log 500$

## 15.205 Restricted bands of operation

MHz	MHz	MHz	GHz
0.090 - 0.110	16.42 - 16.423	399.9 - 410	4.5 - 5.15
<sup>1</sup> 0.495 - 0.505	16.69475 - 16.69525	608 - 614	5.35 - 5.46
2.1735 - 2.1905	16.80425 - 16.80475	960 - 1240	7.25 - 7.75
4.125 - 4.128	25.5 - 25.67	1300 - 1427	8.025 - 8.5
4.17725 - 4.17775	37.5 - 38.25	1435 - 1626.5	9.0 - 9.2
4.20725 - 4.20775	73 - 74.6	1645.5 - 1646.5	9.3 - 9.5
6.215 - 6.218	74.8 - 75.2	1660 - 1710	10.6 - 12.7
6.26775 - 6.26825	108 - 121.94	1718.8 - 1722.2	13.25 - 13.4
6.31175 - 6.31225	123 - 138	2200 - 2300	14.47 - 14.5
8.291 - 8.294	149.9 - 150.05	2310 - 2390	15.35 - 16.2
8.362 - 8.366	156.52475 - 156.52525	2483.5 - 2500	17.7 - 21.4
8.37625 - 8.38675	156.7 - 156.9	2690 - 2900	22.01 - 23.12
8.41425 - 8.41475	162.0125 - 167.17	3260 - 3267	23.6 - 24.0
12.29 - 12.293	167.72 - 173.2	3332 - 3339	31.2 - 31.8
12.51975 - 12.52025	240 - 285	3345.8 - 3358	36.43 - 36.5
12.57675 - 12.57725	322 - 335.4	3600 - 4400	( <sup>2</sup> )

- Remark:
1. Emission level in dBuV/m=20 log (uV/m)
  2. Measurement was performed at an antenna to the closed point of EUT distance of meters.
  3. Only spurious frequency is permitted to locate within the Restricted Bands specified in provision of  $\xi$  15.205, and the emissions located in restricted bands also comply with 15.209 limit.

## 5.4. Measurement Result

Measurement data:

Note: Limit dBuV/m @3m = Limit dBuV/m @300m+ 80

Limit dBuV/m @3m = Limit dBuV/m @30m + 40

9 kHz~30 MHz

Temperature:	22.5°C	Relative Humidity:	43%
Pressure:	101kPa		
Test Voltage :	AC 120V/60Hz	Mode:	Mode 4

Mode4 / Polarization: coaxial

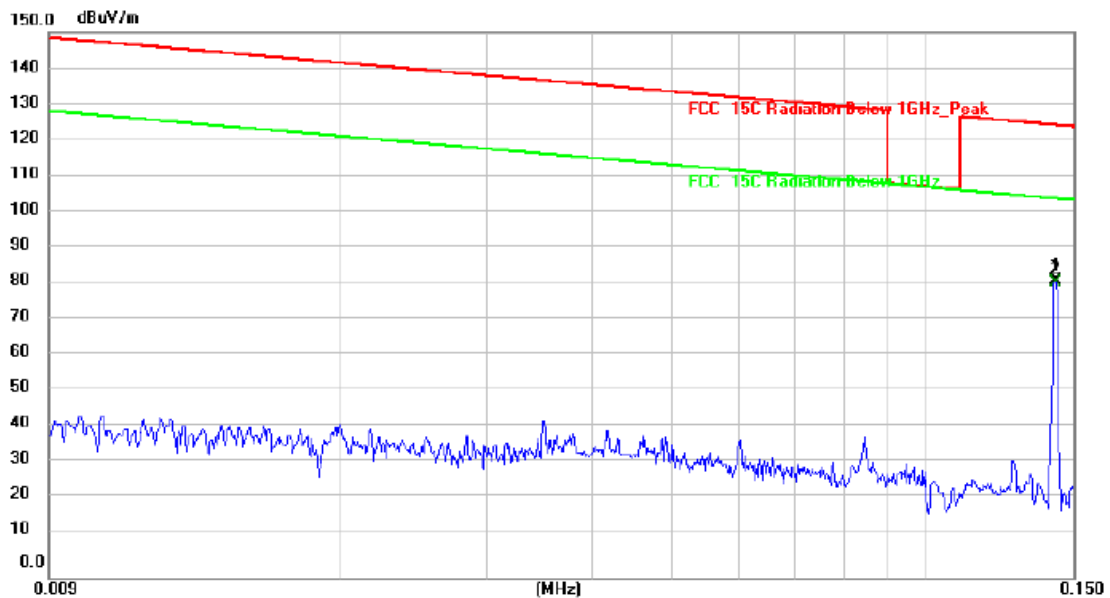

No.	Mk.	Freq.	Reading Level	Correct Factor	Measurement	Limit	Over	Detector	Comment
		MHz	dBuV	dB	dBuV/m	dBuV/m	dB		
1		0.1426	61.69	20.23	81.92	124.54	-42.62	peak	
2	*	0.1426	61.02	20.23	81.25	104.54	-23.29	AVG	

Mode4 / Polarization: coaxial

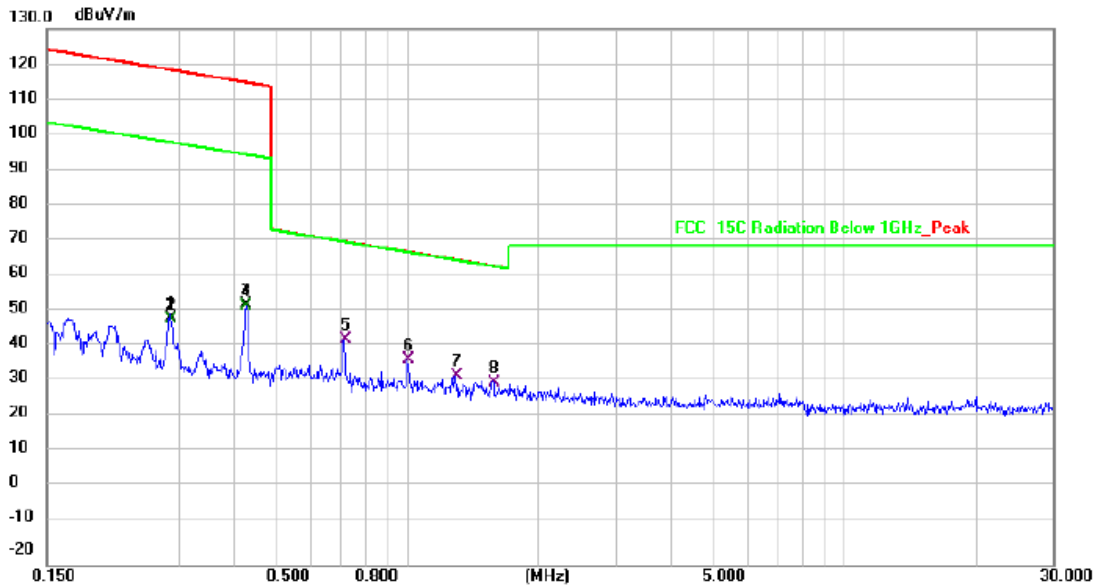

No.	Mk.	Freq. MHz	Reading Level dBuV	Correct Factor dB	Measure- ment dBuV/m	Limit dBuV/m	Over dB	Detector	Comment
1		0.2863	29.03	20.31	49.34	118.48	-69.14	peak	
2		0.2863	28.54	20.31	48.85	98.48	-49.63	AVG	
3		0.4282	32.67	20.35	53.02	114.97	-61.95	peak	
4		0.4282	32.11	20.35	52.46	94.97	-42.51	AVG	
5	*	0.7160	22.68	20.46	43.14	70.51	-27.37	QP	
6		0.9997	16.96	20.57	37.53	67.62	-30.09	QP	
7		1.2892	12.42	20.59	33.01	65.42	-32.41	QP	
8		1.5766	10.44	20.61	31.05	63.68	-32.63	QP	

Note:

Pre-scan in the all of mode, the worst case in of was recorded.

Factor = antenna factor + cable loss – pre-amplifier.

Margin = Emission Level- Limit.

30MHz-1GHz:

Temperature:	22.5°C	Relative Humidity:	43%
Pressure:	101 kPa	Polarization:	Horizontal
Test Voltage:	AC 120V/60Hz	Mode:	Mode 3

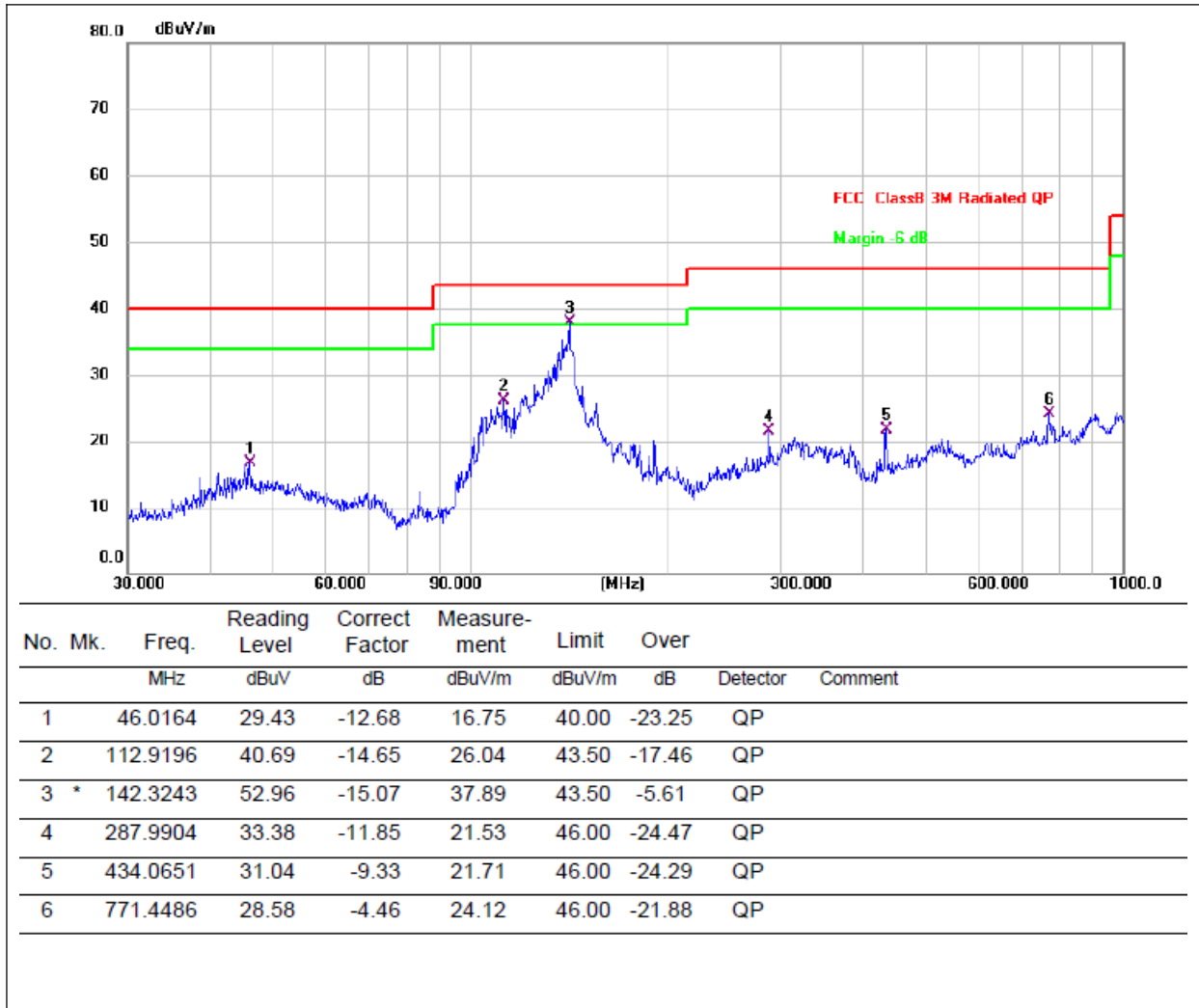

Temperature:	22.5°C	Relative Humidity:	43%
Pressure:	101 kPa	Polarization:	Vertical
Test Voltage:	AC 120V/60Hz	Mode:	Mode 3

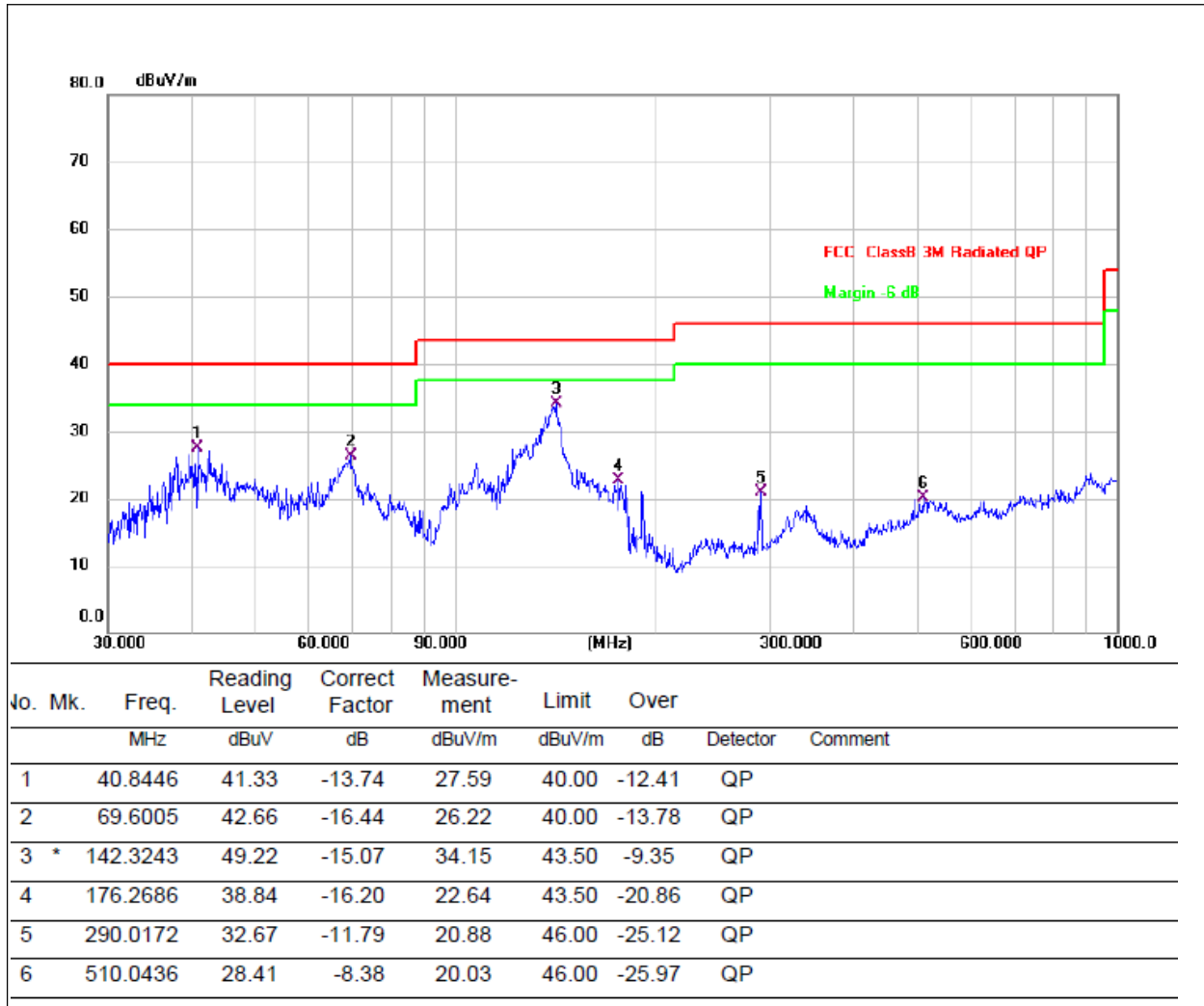

Remarks:

1. Final Level = Receiver Read level + Antenna Factor + Cable Loss – Preamplifier Factor
2. The emission levels of other frequencies are very lower than the limit and not show in test report.

## 7. TEST PHOTOGRAPHS AND EUT PHOTOGRAPHS

Please the attachment for details.

-----The end-----