

# dCC (DIGITAL CONTROL CENTER)

## JOGBOX – CORDLESS AND TETHERED VERSIONS

### USER MANUAL



© Copyright April 2020 Hexagon Manufacturing Intelligence

All rights reserved. Hexagon Manufacturing Intelligence is part of Hexagon. Other brands and product names are trademarks of their respective owners. Hexagon Manufacturing Intelligence believes the information in this publication is accurate as of its publication date. Such information is subject to change without notice

What is documented in this manual is a product of **Hexagon Metrology, Inc.**

**Hexagon Manufacturing Intelligence**

Strada del Portone, 113  
10095 Grugliasco (TO), Italy  
Tel.: (+39) 011 4025 111  
Internet: <http://www.HexagonMI.com>

**Hexagon Manufacturing Intelligence**

250 Circuit Drive  
North Kingstown, RI 02852, U.S.A.  
Tel.: +1 (800) 766-4673  
Internet: <http://www.HexagonMI.com>

**Hexagon Manufacturing Intelligence**

Siegmund-Hiepe- Strasse 2-12,  
35578 Wetzlar, Germany  
Tel.: +49 (0) 6441 207 0  
Internet: <http://www.HexagonMI.com>

**Hexagon Manufacturing Intelligence**

188 Zhuzhou Road  
Qingdao, 266101,  
P.R. China  
Tel.: +86 (532) 870-2188  
Internet: <http://www.HexagonMI.com.cn>

Hexagon Manufacturing Intelligence helps industrial manufacturers develop the disruptive technologies of today and the life-changing products of tomorrow. As a leading metrology and manufacturing solution specialist, our expertise in sensing, thinking and acting – the collection, analysis and active use of measurement data – gives our customers the confidence to increase production speed and accelerate productivity while enhancing product quality.

Through a network of local service centers, production facilities and commercial operations across five continents, we are shaping smart change in manufacturing to build a world where quality drives productivity. For more information, visit [hexagonMI.com](http://hexagonMI.com).

Hexagon Manufacturing Intelligence is part of Hexagon (Nasdaq Stockholm: HEXA B; [hexagon.com](http://hexagon.com)), a leading global provider of information technologies that drive quality and productivity improvements across geospatial and industrial enterprise applications.

# Contents

<b>Contents</b> .....	<b>iii</b>
<b>Preface</b> .....	<b>5</b>
Documentation Provided with the Jogbox.....	6
User Manual.....	6
Conventions .....	6
<b>Safety Information</b> .....	<b>7</b>
EMERGENCY STOP .....	7
2.5. Warnings .....	8
2.6. Safety Devices .....	9
<b>Overview</b> .....	<b>10</b>
Dimensions.....	12
Operation.....	14
EMERGENCY STOP .....	14
SPEED CONTROL .....	14
ENABLE .....	14
JOYSTICK .....	14
MACHINE START .....	14
Keypad .....	15
TOUCHSCREEN DISPLAY .....	18
<b>Appendix A – Battery Replacement</b> .....	<b>27</b>
<b>Appendix B - Glossary</b> .....	<b>28</b>
<b>Declaration of Conformity</b> .....	<b>29</b>
Declaration of Conformity – Applies to European Union.....	29



# Preface

dCC is an operator control pendant often referred to as a jogbox for a Coordinate Measuring Machine (CMM). The pendant allows the operator to move the sensor portion of the CMM to a desired location in the work volume. In addition to driving the machine, dCC allows the operator to pull up part programs on the embedded tablet in the pendant. dCC is available either as a tethered wired version or a wireless version.

This manual was written for Customers who own or intend to purchase the Hexagon Manufacturing Intelligence (hereafter referred to simply as Hexagon) dCC Jogbox (hereafter referred to simply as Jogbox).

This document is a supplement to the operating manual of the CMM. Only after you have read and understood both will you be able to operate the CMM safely with the Jogbox. Which functions you can run from the Jogbox depends on which CMM is connected to it. Therefore, you will find the machine-specific functions in the operating manual of the CMM that is connected to the Jogbox.

Keep the user manual in such a way that it is accessible when required. Ensure that the user manual is always complete and in a readable state. The information it contains is essential to ensure the safety of the equipment and personnel operating it. We therefore recommend you read it carefully before proceeding to use the Jogbox or carrying out maintenance activities.

This documentation is only valid for the versions of the Jogbox described here. The figures and drawings shown are not to scale. All dimensions are in millimeters. This user manual does not claim to be a comprehensive technical description. All the information on the functionalities and specifications hold good only in conjunction with the original accessories of the manufacturer.

This Jogbox is intended for use for operating CMMs that are equipped with a DC and B3C controller.



Note. You may print as many copies of this copyrighted manual as desired for personal use.



Note. Due to continuous product development, the images included in this manual may not resemble the customer's configuration.

## Documentation Provided with the Jogbox

The information provided with the Jogbox offers a wide range of solutions for getting to know and using its functions.

The Jogbox comes with a USB key containing the following documentation.

### User Manual

Contains essential information on how to use the Jogbox safely and efficiently. The manual includes a detailed description of the Jogbox, the instructions for use, and the routine maintenance procedures recommended by Hexagon. This document is provided in the form of a PDF file.

## Conventions

In this documentation, the safety references according to DIN ISO 3864-2 are marked as follows:



### **Danger**

Indicates a hazardous situation that, if not avoided, will result in death or serious injury.



### **Warning**

Indicates a hazardous situation that, if not avoided, could result in death or serious injury.



### **Caution**

Indicates a hazardous situation that, if not avoided, could result in minor or moderate injury or damage to equipment.



### **Notice**

Is used to address practices not related to physical injury.



Note. Tip to make your work easier or reference to further information.

# Safety Information

All the operations described in this document for which you are responsible must be performed in respect of the national, local and company safety regulations.

**In case of conflict with said directives, please contact Hexagon.**

## Purpose-conformant use

The jogbox is available as a tethered or wireless version. In any event, the wireless version shall be able to be operated in a tethered configuration (Cable will supply power only). The wireless communications between the jogbox and the PC as well as the wireless communications between the jogbox and the controller shall be encrypted to avoid hacking or monitoring of signals. The Jogbox is used for operating CMMs that are equipped with a DC and B3C controller. With the Jogbox you can move the axes manually using the joysticks. In addition, you can input and transmit editing commands and commands to the application software of the CMM.

## Impermissible use

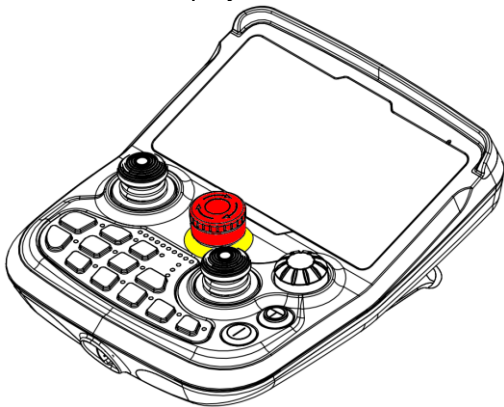
错误!未找到引用源。 identifies the location of the cell components.

## EMERGENCY STOP

To initiate an emergency stop:

1. Press the emergency stop button till it clicks into the lower locked position.

The drives of the CMM are immediately stopped. A corresponding message regarding the fault is shown in the display and notification area.



## Recovering From an E-Stop:

Switch to the operating mode Switched on.

1. Rectify the cause of the emergency stop.
2. Turn the “Emergency stop button” clockwise till the lock of the button gets released.
3. Press the “Reset” button.

The current coordinates of the axes are shown in the display and notification area. The Jogbox has toggled into the “Switched on” operating mode.

## 2.5. Warnings



### **Danger**

When removing covers or parts (except parts removable by hand), live parts can be uncovered and touched. Pay attention to all contacts.



### **Danger**

In case specific maintenance or repair works must be carried out on the open machine with power switched on, this work should be undertaken by authorized personnel only.



### **Danger**

Make sure to use exclusively fuses of the specified type and nominal current.



### **Danger**

Basically, all international and national safety standards have to be observed. Repair operations are to be carried out by authorized personnel of Hexagon Metrology GmbH only. The warranty expires in the event of unauthorized tampering with the System.



### **Danger**

If the safety operation of the system cannot be ensured, the machine must be put to a standstill and to be secured against unintended use.

In this case, please contact Hexagon



## 2.6. Safety Devices



### **Danger**

The system is equipped with specific safety devices for operator protection. These devices should never be put out of use, not even partially.  
Any infraction can lead to physical injuries!

All safety devices have to be checked regularly for correct operation. Possible malfunctions have to be reported immediately to our local subsidiary.  
Refer to the corresponding operating instructions for further information on our safety devices.



### **Notice**

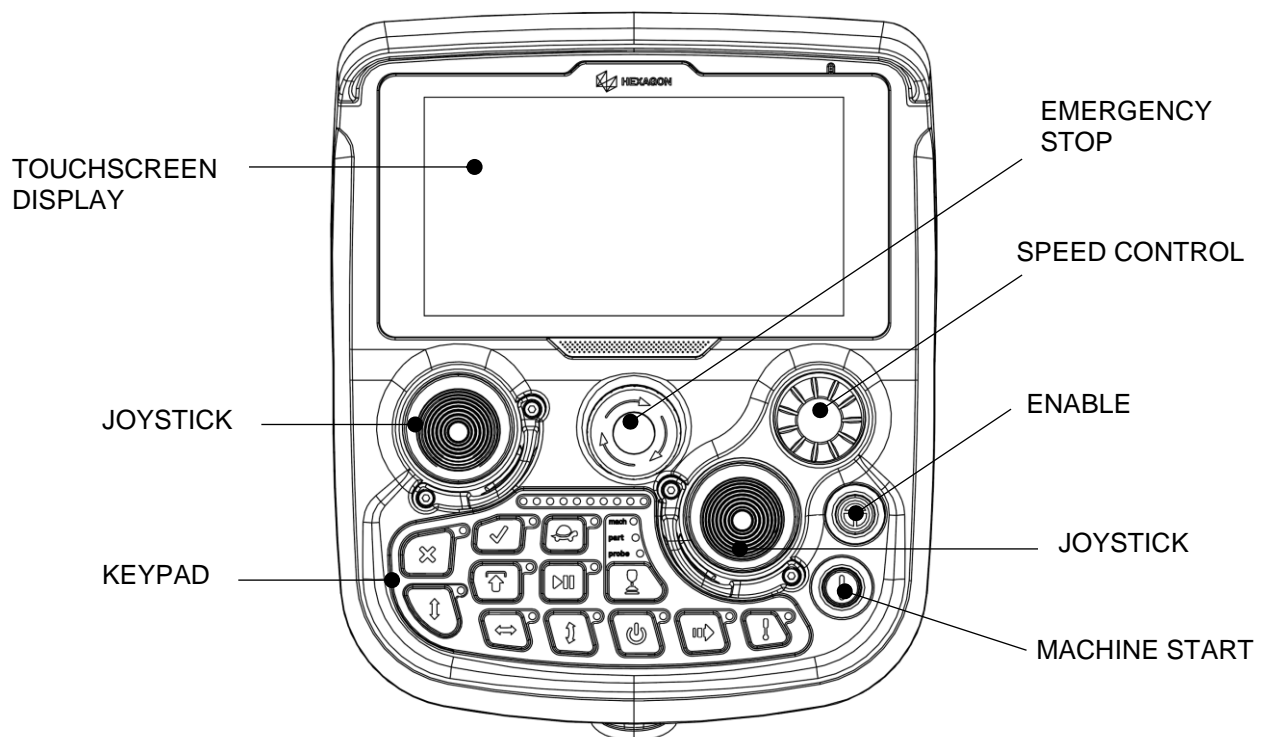
Please observe the safety guidelines of the operating instructions of the machine.

# Overview

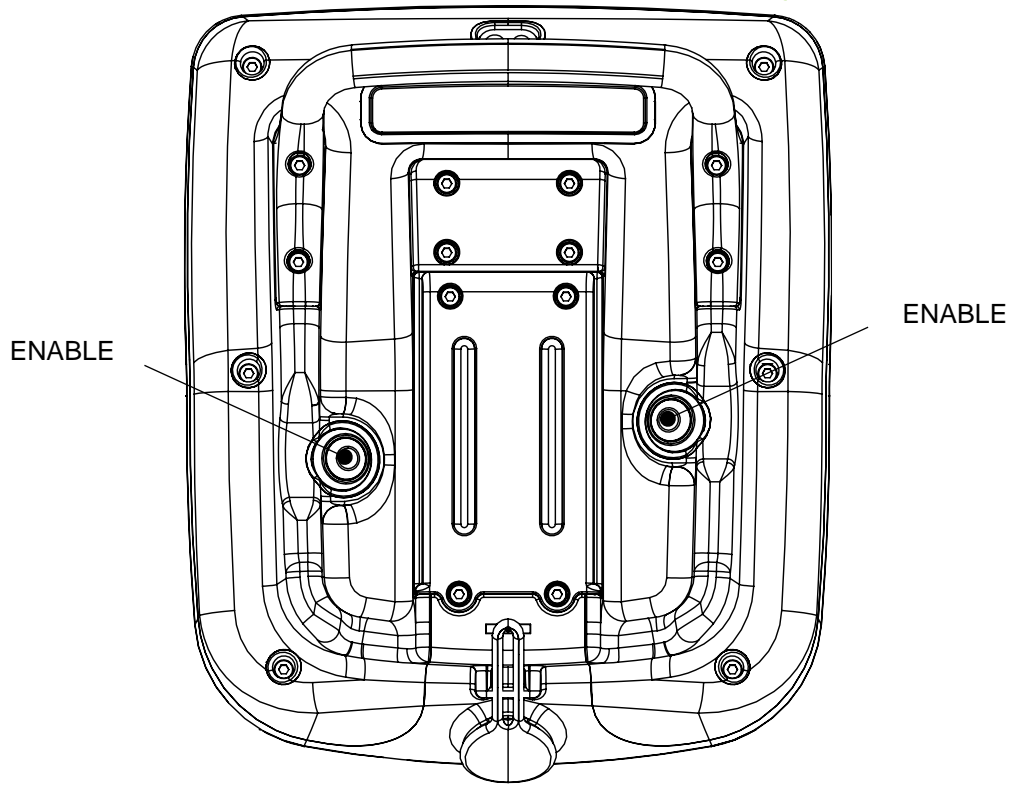
JogBox tethered and JogBox wireless with Base station

The JogBox is a wireless interaction platform for all Hexagon CMM's. It improves user experience, provides advanced functionality and allows for future enhancement, customization, and integration with the HMI Ecosystem.

- The jogbox features a *Windows 10* Tablet with virtual buttons in addition to physical buttons similar to standard Jogboxes.
- Capability to run wireless or tethered.
- Wireless version will have tethered back up capability.
- Capable of Supporting DC and B3C Controllers
- Asymmetrical Thumb Stick Design

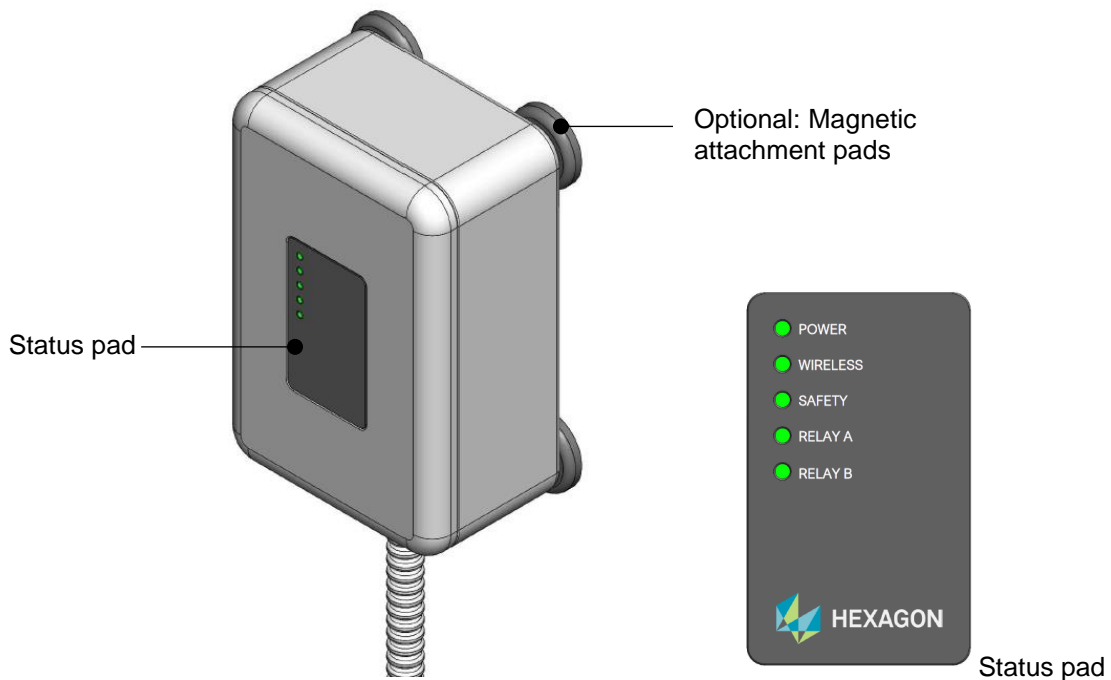


**Figure 1 - The Jogbox - Front**



**Figure 2 - The Jogbox - Rear**

Radio Base Station :  
Connects to the controller and allows the jogbox to communicate with the controller.



## Dimensions



Compact housing design featuring a 5.7" touch panel.

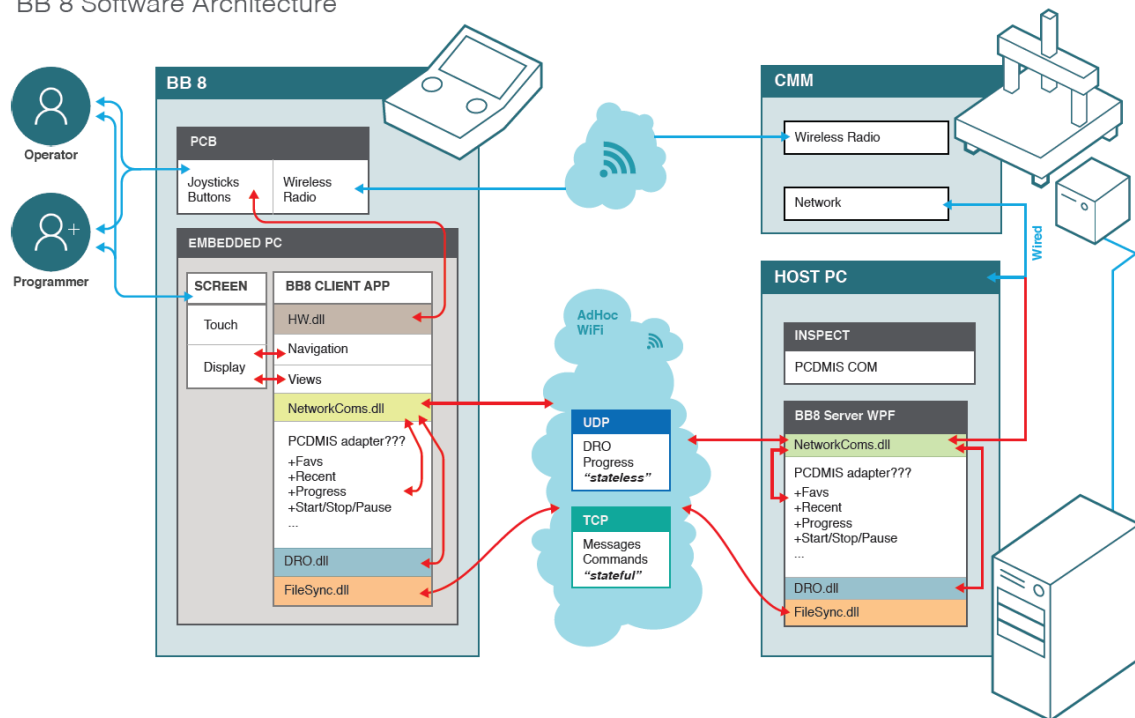
Jogbox	Weight:
Wireless	1.55 kg (3.42 lb)
Tethered	1.40 kg (3.09 lb)

Power Requirements	24V
Software requirements	Windows 10
BATTERY	Lithium rechargeable
BATTERY LIFE	8 HOUR

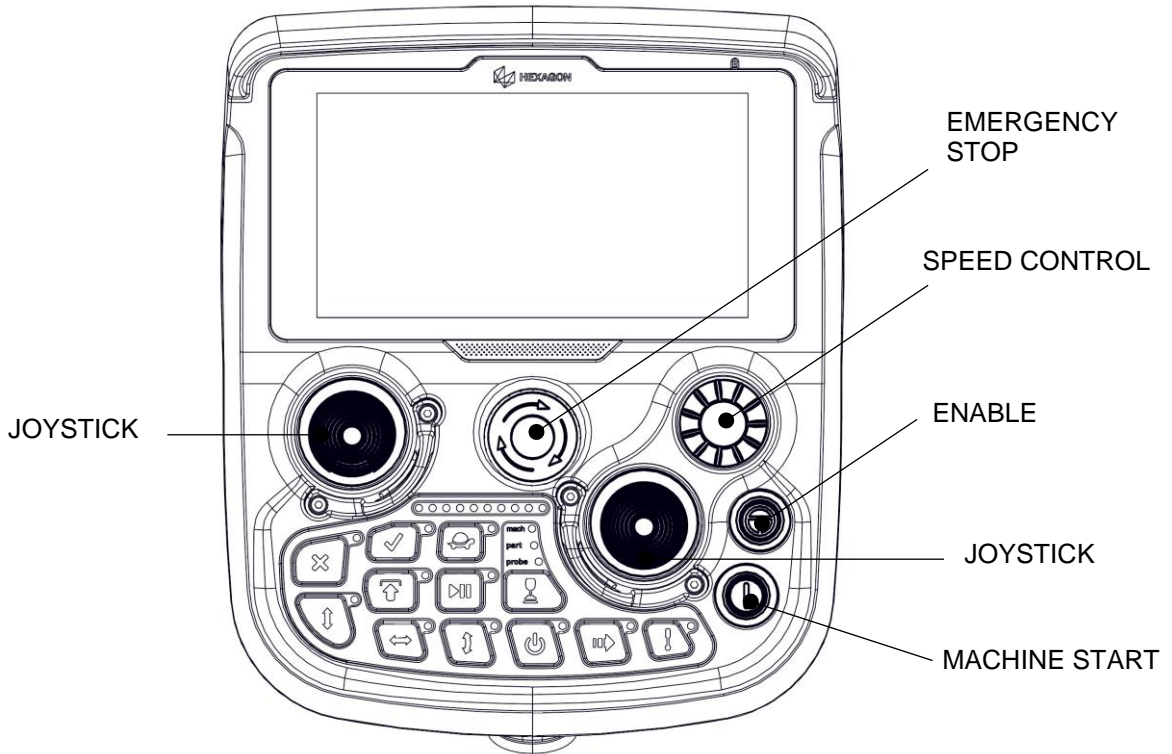


## BB 8 Software Architecture

### BB 8 Software Architecture



## Operation



### EMERGENCY STOP

This latching pushbutton causes an ESTOP condition when depressed. The Emergency Stop button is connected so that it interrupts the supply to the motor drive circuits by de-energizing a control relay. Joystick control is unavailable in this condition. To re-enable system, the ESTOP pushbutton must be unlatched; to do this rotate it clockwise 1/4 turn. Program may need to be reloaded and the MACH START pushbutton depressed (for about 2 seconds) after the cause of the emergency stop is rectified.

### SPEED CONTROL

This knob allows for a variable increase or decrease of machine movement.

### ENABLE

Must be pressed and held while deflecting the joystick to allow the machine to move. This prevents unwanted movement. This button has no function in jogbox mode as the CMM has control of this button.

### JOYSTICK

Provides operator with an independent means of moving the machine's axes at variable speeds. A connection to the three DC servo motors within the controller allows independent axis selection and movement. The joystick will move the probe along the machine's axes in a plus or minus direction as indicated on the portable station. The machine is moved axially by depressing the appropriate axis button and deflecting the joystick in the desired direction.

### MACHINE START

Depress and hold for about 1 second to enable power to the servo drive system. This must be pressed to start homing procedure.

## Keypad

The JOGBOX keypad contains controls for operating the machine. The symbols in the following list of functions refer to the symbols on the Keypad diagram. The functions of these buttons are:



**PROBE ENABLE:** This informs the operator of one of the following three conditions:

- **NOT ILLUMINATED** - The probe is enabled, but the controller will not report hits. Note: Since all probe signals are ignored by the controller, the machine will not stop moving after the probe has registered a hit.



Attempting to take points while this condition exists may result in damage to probe.

- **ILLUMINATED** - The probe is enabled and the host computer is ready to accept a point location.
- **FLASHING** - This temporarily disables probe. This feature is useful when manually aligning a part to a machine axis or when cleaning a probe tip. Hits taken will not be recorded. Re-enabling the probe changes the indicator light from flashing to illuminated.

**SHIFT:** This is used to access the lower registers of buttons with two fields. (X/A, Y/B, Z/W, LOCK/UNLOCK, RUN/HOLD). When active, the lower registers can be accessed. W is for other machines with optional rotary tables.



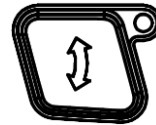
Power On/Off:



### AXES BUTTONS

This constrains movement of the machine to the selected axes when the joystick is deflected. Axes with illuminated LED's are active. When SHIFT is active, the upper register X-, Y- and Z-axis cannot be activated but the lower register A- and B- axis can be, if available. X-, Y- and Z-axis represent the axes of the machine. A- and B- refer to the axes of the motorized wrist.

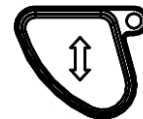
**Z AXIS:** Must be pressed to unlock Z joystick enable. This prevents unwanted movement.



**X AXIS:** Must be pressed to unlock X joystick enable. This prevents unwanted movement.



**Y AXIS:** Must be pressed to unlock Y joystick enable. This prevents unwanted movement.



**DEL PNT:** This will delete last point manually taken.



**MOVE POINT:** This button is used to learn positional moves, enter points or to continue program execution when prompted. When learning positional moves or entering points, the coordinate values at that location are recorded when "Move Point" is pressed. The function of this button is software dependent.

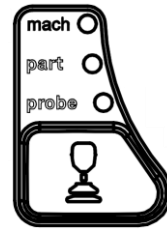


**RUN/HOLD:** This is a two function button: the HOLD button stops program execution, accessed by pressing this button with SHIFT inactive. RUN resumes execution of a program placed in HOLD state, activated by SHIFT (lighting SHIFT LED) then pressing RUN; RUN LED lights.



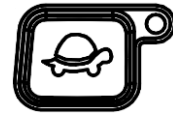


**JOG MODE:** PROBE/PART/MACH LEDs light to identify each motion mode that machine is in. These settings can be toggled to vary the way probe is manually steered. This promotes probe contact at right angles to part, which improves measuring accuracy and repeatability.



- **MACH:** WHEN THIS LED IS LIT, PROBE MOVES IN THE
  - MACHINE'S COORDINATE SYSTEM. THIS IS THE DEFAULT POSITION.
- **PART:** WHEN THIS LED IS LIT, PROBE MOVES ACCORDING
  - TO THE PART COORDINATE SYSTEM.
- **PROBE:** WHEN SUPPORTED THIS LED IS LIT, THE PROBE
  - MOVES IN LINE WITH ITS OWN CENTER AXIS.

**SLOW:** This button enables either slow machine movement (LED illuminated) or fast machine movement (LED extinguished).

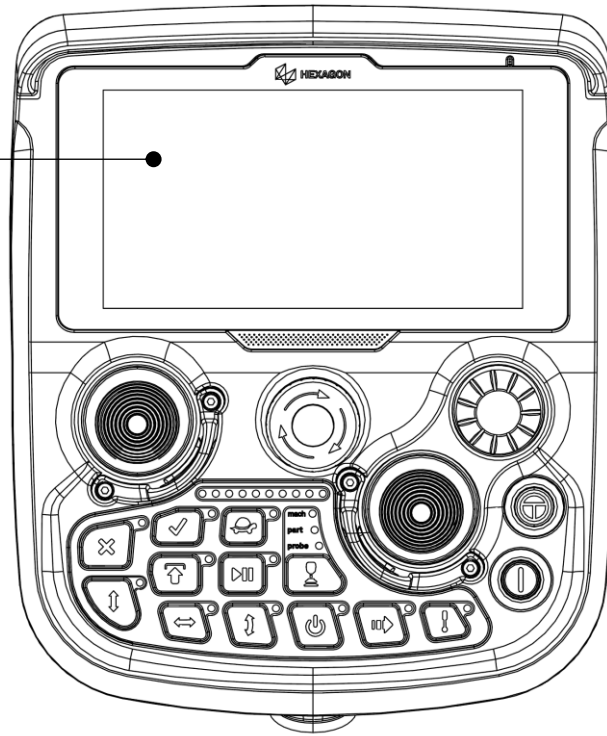


**DONE:** This is used to accept and register software commands. The function of this button is software dependent.



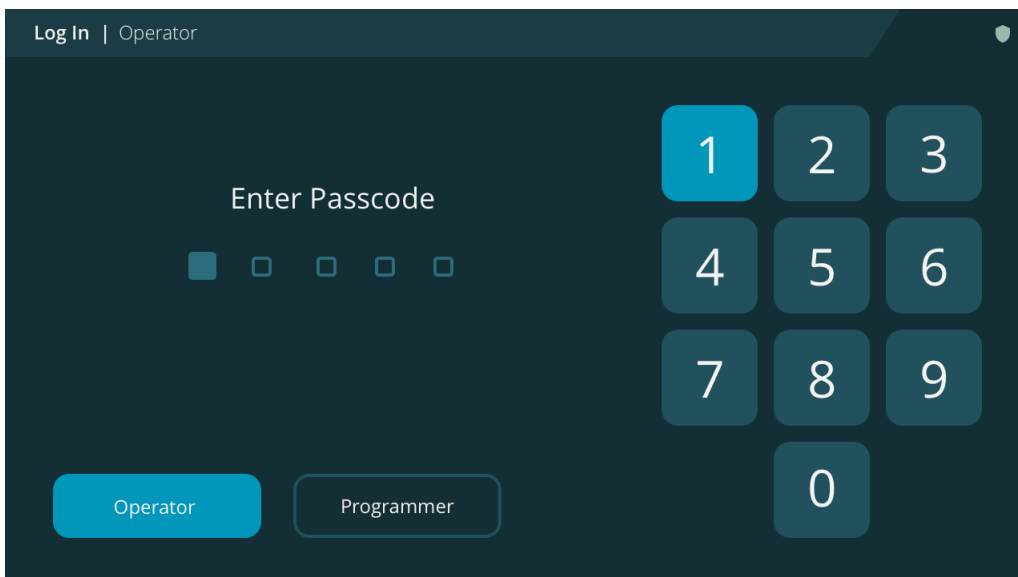
## TOUCHSCREEN DISPLAY

TOUCHSCREEN  
DISPLAY



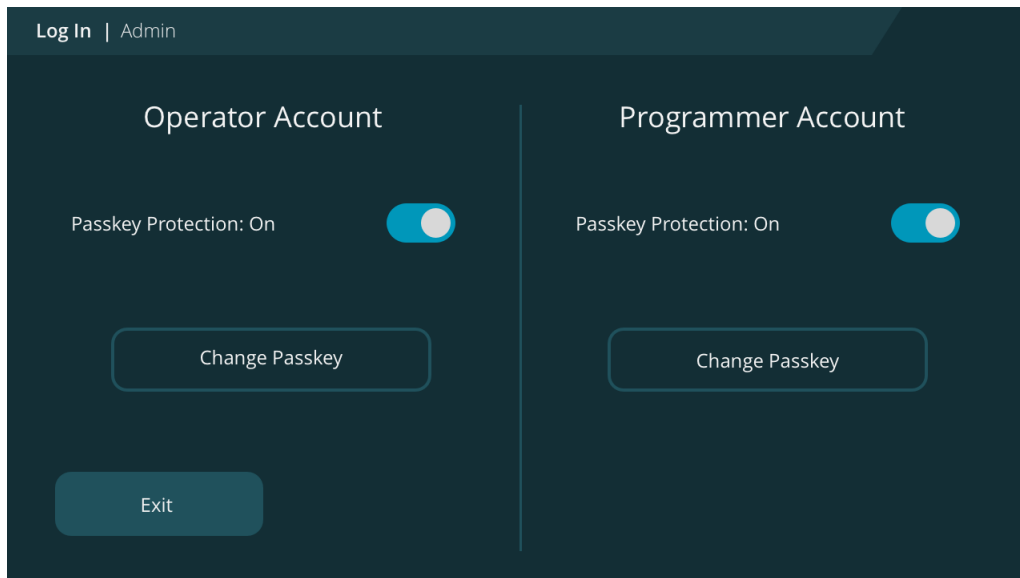
### Log In

Enter Passcode

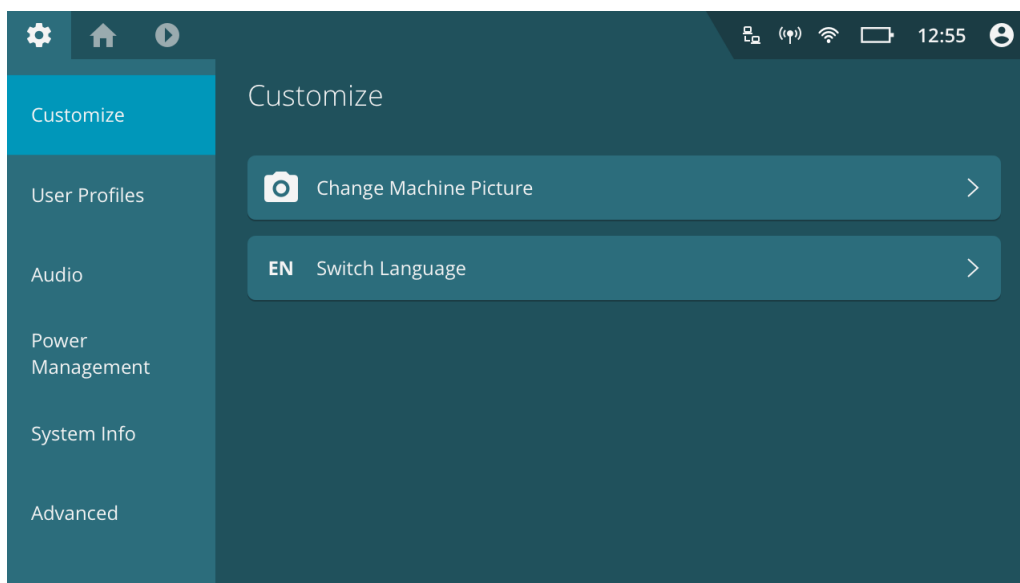


- Operator
- Programmer

## Change Passkey

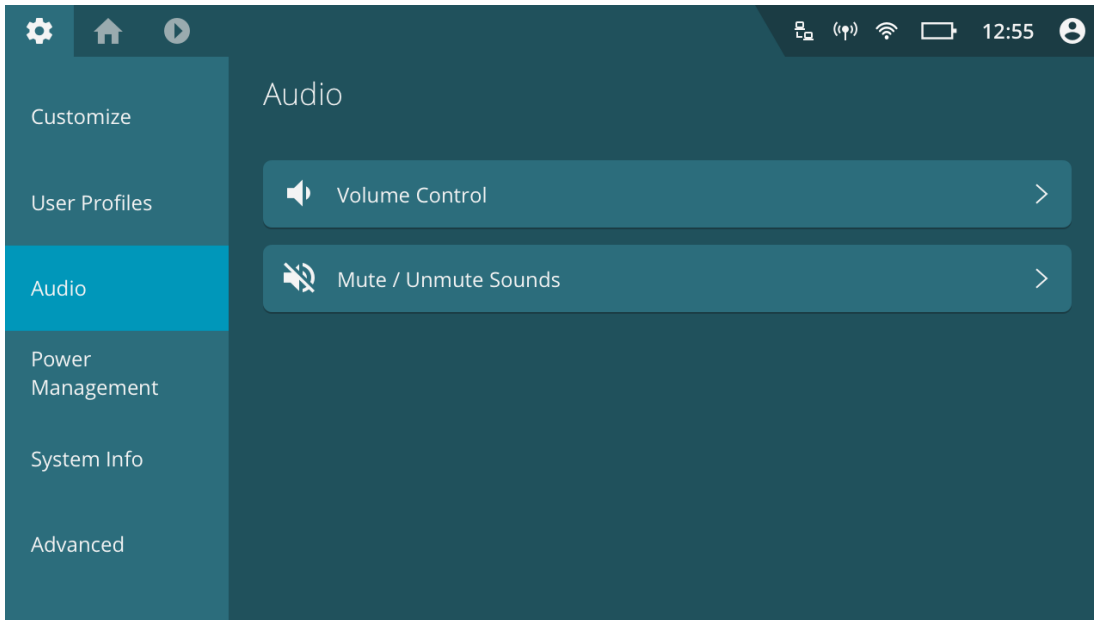


## Setting – Customize



- Change Machine Picture
- Language
- Zero Joysticks
- Set Logout time

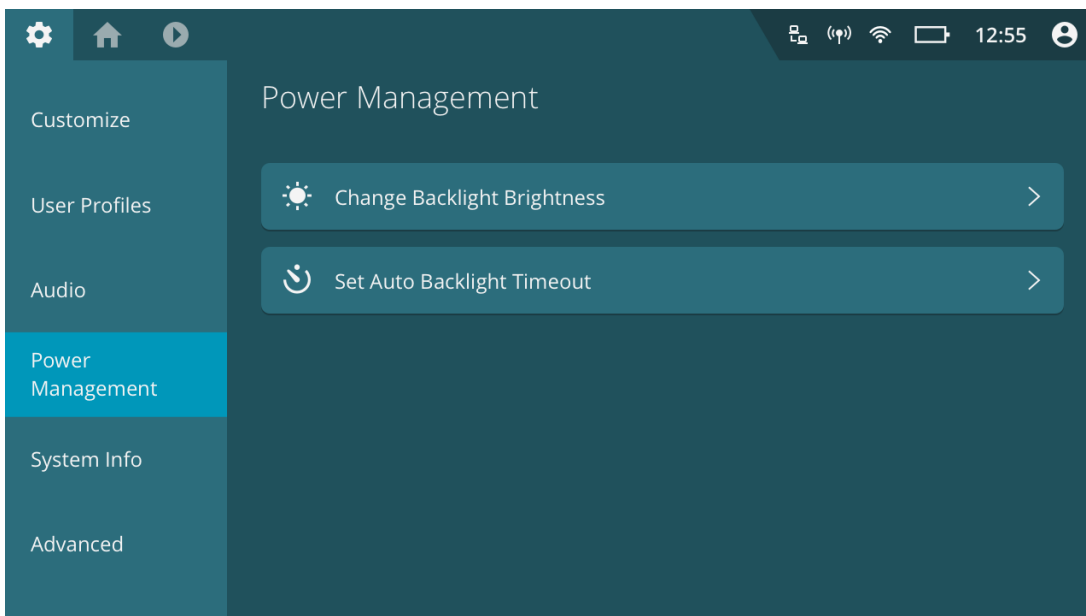
## Audio - Notification sounds

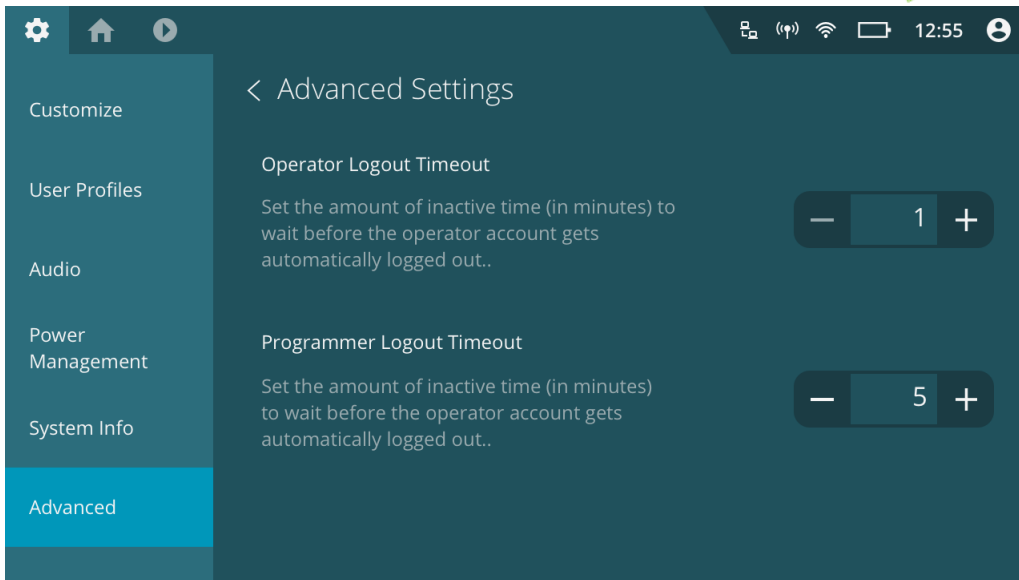


- Volume
- Mute

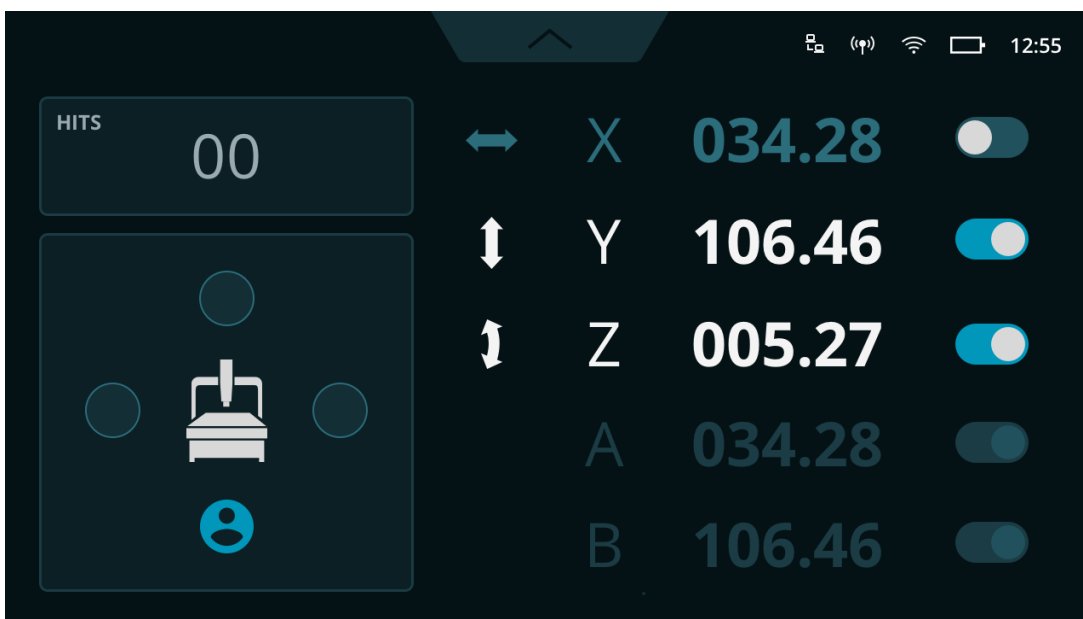
## Power Management

- Change Backlight Brightness
- Set Auto Backlight Timeout





Position – set the operator position

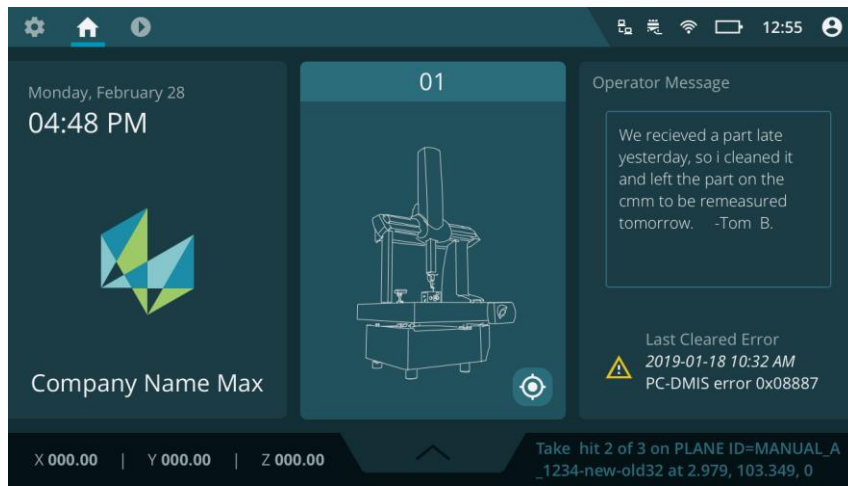


Check for updates



- Swipe left to go to the Home page

## Home Page

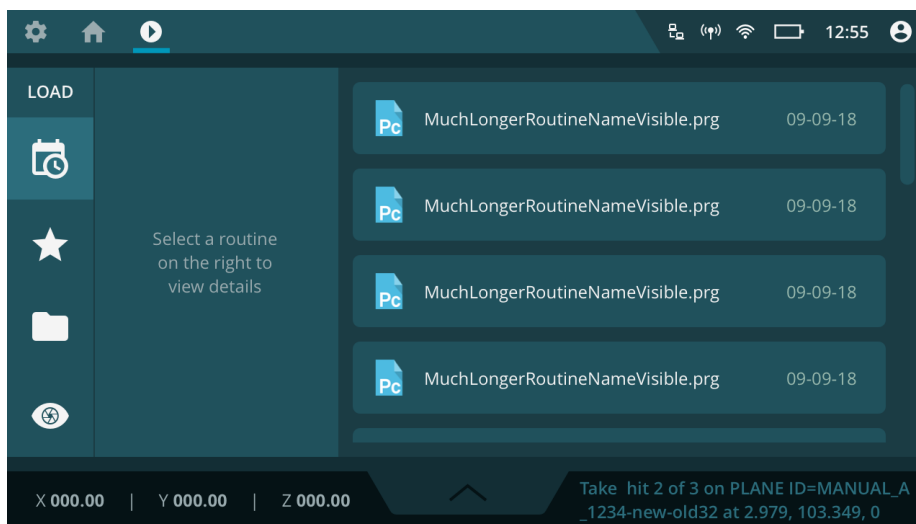



- Swipe right to return to the Settings page

- Type/Model of CMM
- User Data
- Interactive jogbox Manual
- Machine Name
- User Type




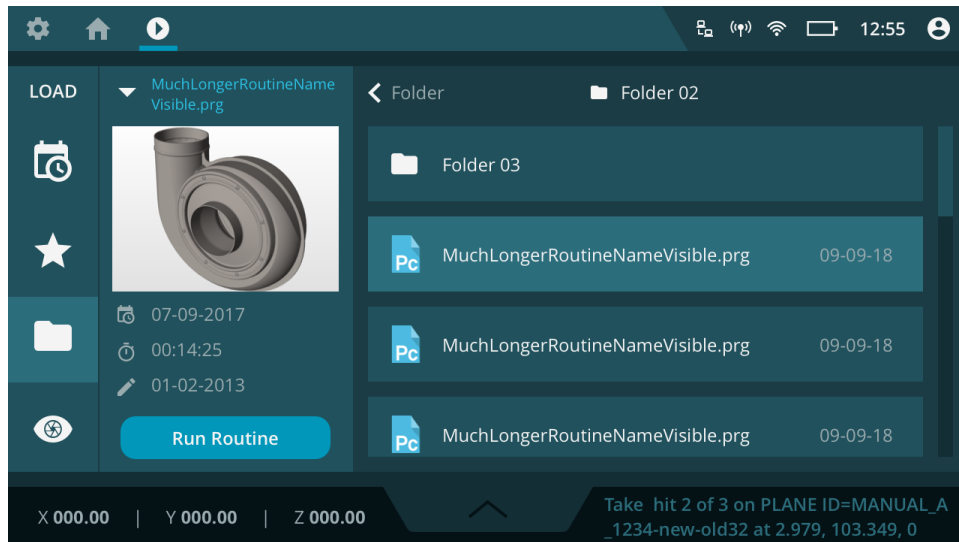
- Swipe right to go to the Routine page



-  Swipe down to go to the JOGMode

### Routine Page

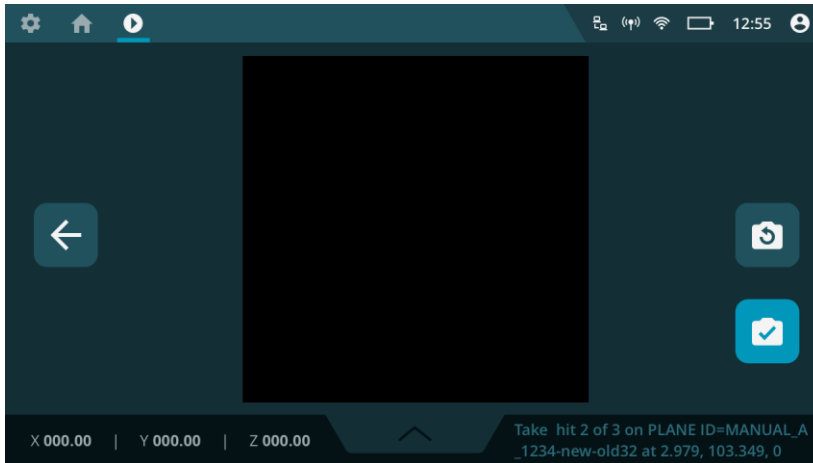
-  Swipe left to return to the Home page
- Run Routine




- Load Edit programs
  - Load recent programs
  - Load favorite programs
  - Browse programs
- View Routine - Results




- Take picture - Camera Live View






- Open Routine

-  Swipe down to go to the JOGMode

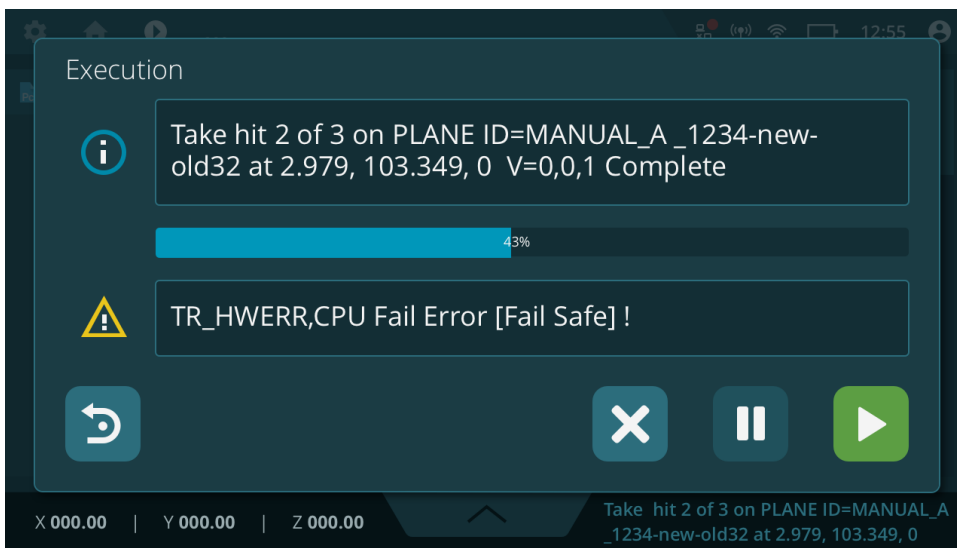
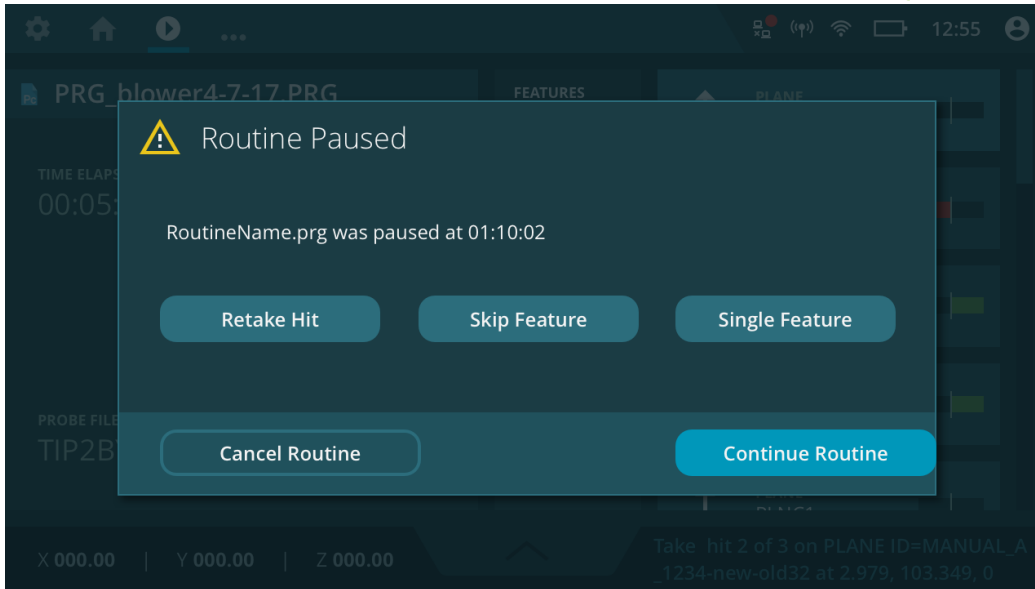
Run

-  Swipe down to go to the JOGMode

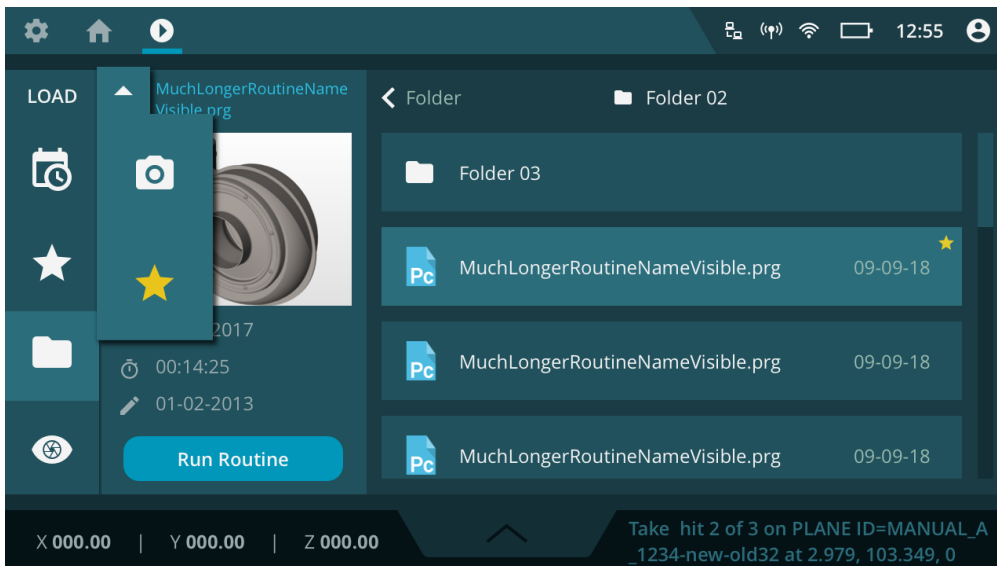
JOGMode XYZ

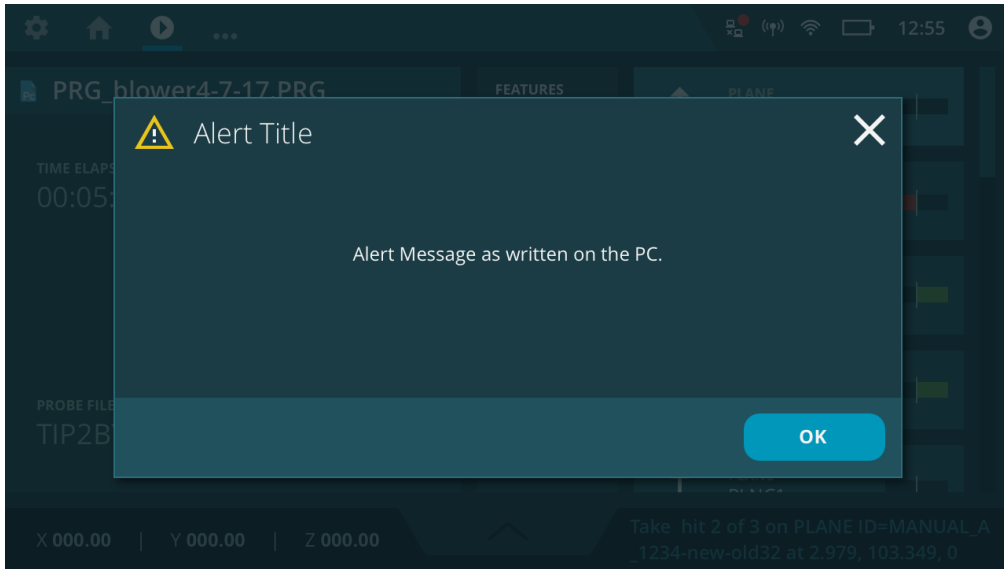
-  Swipe right to go to the JOGModeWABC
-  Swipe right to return to JOGMode XYZ
-  Swipe up to return to the previous page





Take picture / Favorite

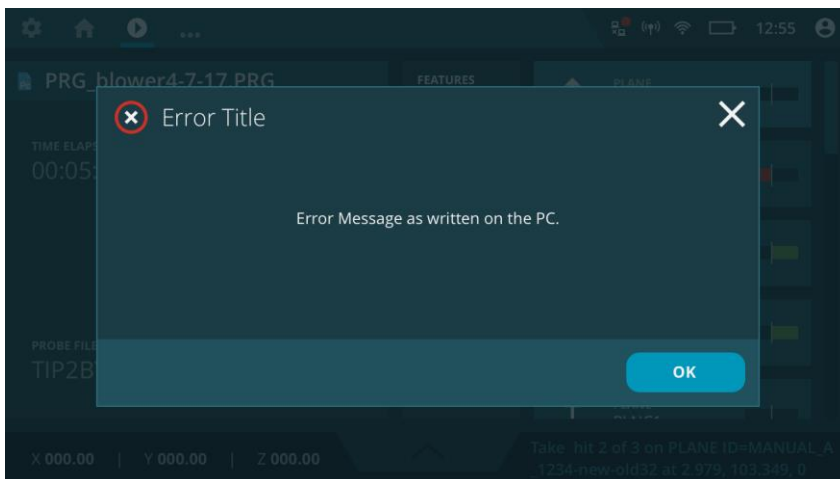




#### Alert (Popup)

- Crash Detected
- Controller Error
- Software Error

Resolve/Close/Dismiss Alert, returns to previous screen



# Appendix A – Battery Replacement

Only personnel trained in proper handling and disposal should replace the Lithium batteries.

Replace only with Lithium batteries of the same type from Hexagon and no others.



## **Danger**

Do not handle the Lithium batteries without protection gear.



## **Warning**

Batteries may explode is damaged.



# Appendix B - Glossary

Text...

# Declaration of Conformity

Declaration of Conformity – Applies to European Union  
The

# FCC Statement

## **FCC 15.19 (a) (3)**

This device complies with part 15 of the FCC rules. Operation is subject to the following two conditions: (1) this device may not cause harmful interference, and (2) this device must accept any interference received, including interference that may cause undesired operation.

## **FCC 15.21**

**NOTE:** The manufacturer is not responsible for any radio or TV interference caused by unauthorized modifications to this equipment. Such modifications could void the user's authority to operate the equipment.

## **FCC 15.105**

**NOTE:** This equipment has been tested and found to comply with the limits for a Class B digital device, pursuant to part 15 of the FCC Rules. These limits are designed to provide reasonable protection against harmful interference in a residential installation. This equipment generates uses and can radiate radio frequency energy and, if not installed and used in accordance with the instructions, may cause harmful interference to radio communications. However, there is no guarantee that interference will not occur in a particular installation. If this equipment does cause harmful interference to radio or television reception, which can be determined by turning the equipment off and on, the user is encouraged to try to correct the interference by one or more of the following measures:

- Reorient or relocate the receiving antenna.
- Increase the separation between the equipment and receiver.
- Connect the equipment into an outlet on a circuit different from that to which the receiver is connected.
- Consult the dealer or an experienced radio/TV technician for help
- This device and its antenna(s) must not be co-located or operating in conjunction with any other antenna or transmitter.

## **RF Exposure Information and Statement**

The SAR limit of USA (FCC) is 1.6 W/kg averaged over one gram of tissue. Device (FCC ID: 2AXRK-HEX01DCC) has also been tested against this SAR limit. This device was tested for typical body-worn operations kept 10mm from the body. To maintain compliance with FCC RF exposure requirements, use accessories that maintain a 10mm separation distance between the user's body. The use of belt clips, holsters and similar accessories should not contain metallic components in its assembly. The use of accessories that do not satisfy these requirements may not comply with FCC RF exposure requirements, and should be avoided.

---

## 5G Wi-Fi Restriction information

Operation in the band 5150-5350MHz is only for indoor use to reduce the potential for harmful interference to co-channel mobile satellite systems.

# IC statement

This device complies with RSS-247 and RSS-210 of Industry Canada. Operation is subject to the following two conditions: (1) this device may not cause harmful interference, and (2) this device must accept any interference received, including interference that may cause undesired operation.

Le présent appareil est conforme aux CNR d'Industrie Canada applicables aux appareils radio exempts de licence. L'exploitation est autorisée aux deux conditions suivantes: (1) l'appareil ne doit pas produire de brouillage, et (2) l'utilisateur de l'appareil doit accepter tout brouillage radioélectrique subi, même si le brouillage est susceptible d'en compromettre le fonctionnement.

This Class B digital apparatus complies with Canadian ICES-003.

Cet appareil numérique de la classe B est conforme à la norme NMB-003 du Canada.



[www.hexagonMI.com](http://www.hexagonMI.com)

