



# Radio Test Report

## FCC ID: 2AXQX-4001340

**Report No.** : TBR-C-202204-0403-31  
**Applicant** : Marpac, LLC  
**Equipment Under Test (EUT)**  
**EUT Name** : Rohm Voyager, Rohm+  
**Model No.** : 4001340  
**Series Model No.** : 4001341  
**Brand Name** : Yogasleep  
**Sample ID** : 202204-0403-3-1#&202204-0403-3-2#  
**Receipt Date** : 2022-07-10  
**Test Date** : 2022-07-10 to 2022-07-28  
**Issue Date** : 2022-07-28  
**Standards** : FCC Part 15 Subpart C 15.247  
**Test Method** : ANSI C63.10: 2013  
KDB 558074 D01 15.247 Meas Guidance v05r02  
**Conclusions** : **PASS**

In the configuration tested, the EUT complied with the standards specified above.

**Witness Engineer** : 

Seven Wu

**Engineer Supervisor** : 

Ivan Su

**Engineer Manager** : 

Ray Lai

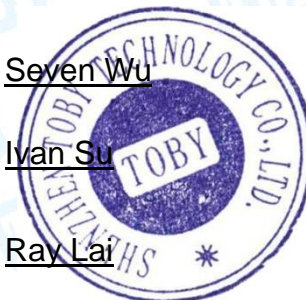

This report details the results of the testing carried out on one sample. The results contained in this test report do not relate to other samples of the same product. The manufacturer should ensure that all products in series production are in conformity with the product sample detailed in the report.

# Contents

**CONTENTS.....2**

**1. GENERAL INFORMATION ABOUT EUT .....5**

1.1 Client Information.....5

1.2 General Description of EUT (Equipment Under Test) .....5

1.3 Block Diagram Showing the Configuration of System Tested.....7

1.4 Description of Support Units .....7

1.6 Description of Test Software Setting .....9

1.7 Measurement Uncertainty .....9

1.8 Test Facility.....10

**2. TEST SUMMARY .....11**

**3. TEST SOFTWARE.....11**

**4. TEST EQUIPMENT .....12**

**5. CONDUCTED EMISSION.....13**

5.1 Test Standard and Limit.....13

5.2 Test Setup.....13

5.3 Test Procedure.....13

5.4 Deviation From Test Standard.....14

5.5 EUT Operating Mode .....14

5.6 Test Data.....14

**6. RADIATED AND CONDUCTED UNWANTED EMISSIONS.....15**

6.1 Test Standard and Limit.....15

6.2 Test Setup.....15

6.3 Test Procedure.....17

6.4 Deviation From Test Standard.....18

6.5 EUT Operating Mode .....18

6.6 Test Data.....18

**7. EMISSIONS IN RESTRICTED BANDS .....19**

7.1 Test Standard and Limit.....19

7.2 Test Setup.....19

7.3 Test Procedure.....20

7.4 Deviation From Test Standard.....21

7.5 EUT Operating Mode .....21

7.6 Test Data.....21

**8. 99% OCCUPIED AND 20DB BANDWIDTH.....22**

8.1 Test Standard and Limit.....22

8.2 Test Setup.....22

8.3 Test Procedure.....22

8.4 Deviation From Test Standard.....23

8.5 EUT Operating Mode .....23

8.6 Test Data.....23

---

<b>9.</b>	<b>PEAK OUTPUT POWER TEST.....</b>	<b>24</b>
9.1	Test Standard and Limit.....	24
9.2	Test Setup.....	24
9.3	Test Procedure.....	24
9.4	Deviation From Test Standard.....	25
9.5	EUT Operating Mode .....	25
9.6	Test Data.....	25
<b>10.</b>	<b>CARRIER FREQUENCY SEPARATION.....</b>	<b>26</b>
10.1	Test Standard and Limit .....	26
10.2	Test Setup.....	26
10.3	Test Procedure.....	26
10.4	Deviation From Test Standard.....	27
10.5	Antenna Connected Construction.....	27
10.6	Test Data.....	27
<b>11.</b>	<b>TIME OF OCCUPANCY (DWELL TIME).....</b>	<b>28</b>
11.1	Test Standard and Limit .....	28
11.2	Test Setup.....	28
11.3	Test Procedure.....	28
11.4	Deviation From Test Standard.....	29
11.5	Antenna Connected Construction.....	29
11.6	Test Data.....	29
<b>12.</b>	<b>NUMBER OF HOPPING FREQUENCIES.....</b>	<b>30</b>
12.1	Test Standard and Limit .....	30
12.2	Test Setup.....	30
12.3	Test Procedure.....	30
12.4	Deviation From Test Standard.....	31
12.5	Antenna Connected Construction.....	31
12.6	Test Data.....	31
<b>13.</b>	<b>ANTENNA REQUIREMENT.....</b>	<b>32</b>
13.1	Test Standard and Limit .....	32
13.2	Deviation From Test Standard.....	32
13.3	Antenna Connected Construction.....	32
13.4	Test Data.....	32
<b>14.</b>	<b>PHOGRAPHS-CONSTRUCTIONAL DETAILS.....</b>	<b>33</b>
<b>15.</b>	<b>PHOTOGRAPHS-TEST SETUP .....</b>	<b>37</b>
	<b>ATTACHMENT A-- CONDUCTED EMISSION TEST DATA .....</b>	<b>39</b>
	<b>ATTACHMENT B--UNWANTED EMISSIONS DATA .....</b>	<b>41</b>



# 1. General Information about EUT

## 1.1 Client Information

<b>Applicant</b>	:	Marpac, LLC
<b>Address</b>	:	2015 Capital Drive, Wilmington, NC 28405
<b>Manufacturer</b>	:	Shen zhen Hi-FiD Electronics Tech Co., Ltd
<b>Address</b>	:	4F~ 5F B7 & 3F B17, Hengfeng Industrial Town, Zhoushi Road, Bao'an District, Shenzhen City, China. 518126.

## 1.2 General Description of EUT (Equipment Under Test)

<b>EUT Name</b>	:	Rohm Voyager, Rohm+	
<b>HVIN/Models No.</b>	:	4001340, 4001341	
<b>Model Different</b>	:	All these models are identical in the same PCB, layout and electrical circuit, the only difference is appearance colors.	
<b>Product Description</b>	:	Operation Frequency:	Bluetooth 5.0(BDR+EDR): 2402MHz~2480MHz
		Number of Channel:	79 channels
		Antenna Gain:	-0.58dBi PCB Antenna
		Modulation Type:	GFSK(1Mbps) $\pi$ /4-DQPSK(2Mbps) 8-DPSK(3Mbps)
<b>Power Rating</b>	:	Input: DC 5V/1A DC 3.7V by 1200mAh Li-ion battery	
<b>Software Version</b>	:	----	
<b>Hardware Version</b>	:	----	
<b>Remark:</b>			
(1)The antenna gain and adapter provided by the applicant, the verified for the RF conduction test provided by TOBY test lab.			
(2)For a more detailed features description, please refer to the manufacturer's specifications or the User's Manual.			
(3)Antenna information provided by the applicant.			

(4)Channel List:

Bluetooth Channel List					
Channel	Frequency (MHz)	Channel	Frequency (MHz)	Channel	Frequency (MHz)
00	2402	27	2429	54	2456
01	2403	28	2430	55	2457
02	2404	29	2431	56	2458
03	2405	30	2432	57	2459
04	2406	31	2433	58	2460
05	2407	32	2434	59	2461
06	2408	33	2435	60	2462
07	2409	34	2436	61	2463
08	2410	35	2437	62	2464
09	2411	36	2438	63	2465
10	2412	37	2439	64	2466
11	2413	38	2440	65	2467
12	2414	39	2441	66	2468
13	2415	40	2442	67	2469
14	2416	41	2443	68	2470
15	2417	42	2444	69	2471
16	2418	43	2445	70	2472
17	2419	44	2446	71	2473
18	2420	45	2447	72	2474
19	2421	46	2448	73	2475
20	2422	47	2449	74	2476
21	2423	48	2450	75	2477
22	2424	49	2451	76	2478
23	2425	50	2452	77	2479
24	2426	51	2453	78	2480
25	2427	52	2454		
26	2428	53	2455		

### 1.3 Block Diagram Showing the Configuration of System Tested

**Conducted Test**

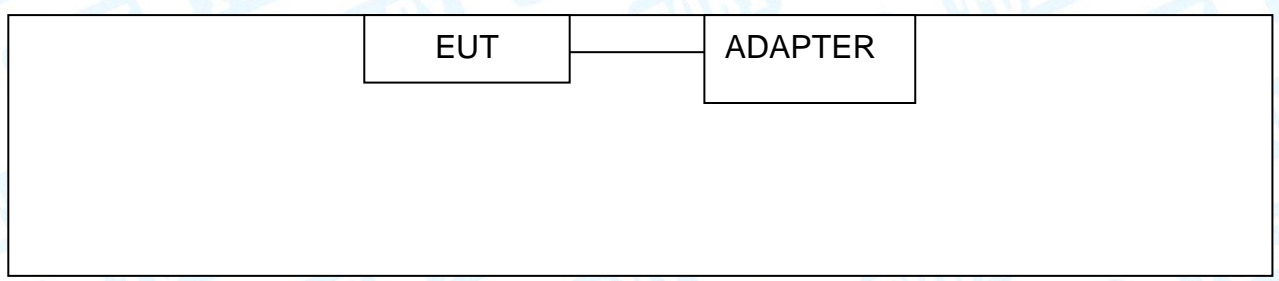

**Radiated Test**

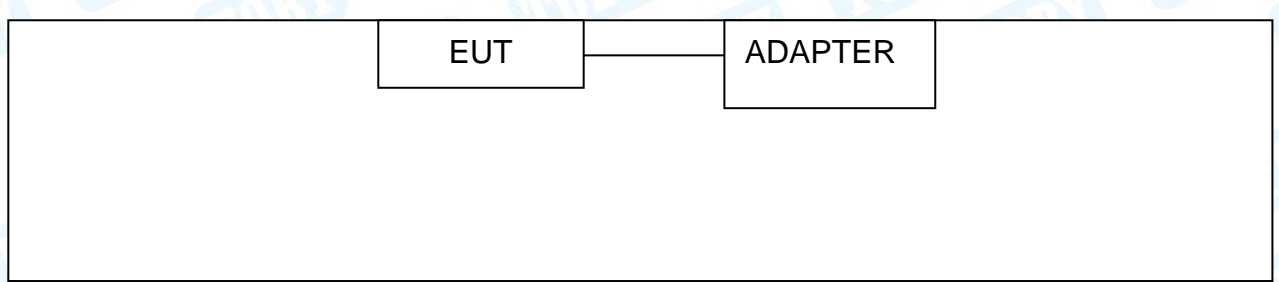

### 1.4 Description of Support Units

Equipment Information				
Name	Model	FCC ID/VOC	Manufacturer	Used “√”
---	---	---	---	---
Cable Information				
Number	Shielded Type	Ferrite Core	Length	Note
Cable 1	Yes	NO	1.05M	Accessory

## 1.5 Description of Test Mode

To investigate the maximum EMI emission characteristics generated from EUT, the test system was pre-scanning tested based on the consideration of following EUT operation mode or test configuration mode which possibly have effect on EMI emission level. Each of these EUT operation mode(s) or test configuration mode(s) mentioned below was evaluated respectively.

For Conducted Test	
Final Test Mode	Description
Mode 1	Charging + TX GFSK Mode Channel 00
For Radiated Test	
Final Test Mode	Description
Mode 1	TX GFSK Mode Channel 00
Mode 2	TX Mode(GFSK) Channel 00/39/78
Mode 3	TX Mode( $\pi/4$ -DQPSK) Channel 00/39/78
Mode 4	TX Mode(8-DPSK) Channel 00/39/78
Mode 5	Hopping Mode(GFSK)
Mode 6	Hopping Mode( $\pi/4$ -DQPSK)
Mode 7	Hopping Mode(8-DPSK)

**Note:**

- (1) For all test, we have verified the construction and function in typical operation. And all the test modes were carried out with the EUT in transmitting operation in maximum power with all kinds of data rate.  
According to ANSI C63.10 standards, the measurements are performed at the highest, middle, lowest available channels, and the worst case data rate as follows:  
 TX Mode: GFSK (1 Mbps)  
 TX Mode:  $\pi/4$ -DQPSK (2 Mbps)  
 TX Mode: 8-DPSK (3 Mbps)
- (2) During the testing procedure, the continuously transmitting with the maximum power mode was programmed by the customer.
- (3) The EUT is considered a portable unit; in normal use it was positioned on X-plane. The worst case was found positioned on X-plane. Therefore only the test data of this X-plane was used for radiated emission measurement test.



### 1.6 Description of Test Software Setting

During testing channel & Power controlling software provided by the customer was used to control the operating channel as well as the output power level. The RF output power selection is for the setting of RF output power expected by the customer and is going to be fixed on the firmware of the final end product power parameters of RF setting.

Test Software Version	FCC_assist_1.0.2.2		
Frequency	2402 MHz	2441MHz	2480 MHz
GFSK	DEF	DEF	DEF
$\pi/4$ -DQPSK	DEF	DEF	DEF
8-DPSK	DEF	DEF	DEF

### 1.7 Measurement Uncertainty

The reported uncertainty of measurement  $y \pm U$ , where expanded uncertainty  $U$  is based on a standard uncertainty multiplied by a coverage factor of  $k=2$ , providing a level of confidence of approximately 95 %.

Test Item	Parameters	Expanded Uncertainty ( $U_{Lab}$ )
Conducted Emission	Level Accuracy: 9kHz~150kHz 150kHz to 30MHz	$\pm 3.50$ dB $\pm 3.10$ dB
Radiated Emission	Level Accuracy: 9kHz to 30 MHz	$\pm 4.60$ dB
Radiated Emission	Level Accuracy: 30MHz to 1000 MHz	$\pm 4.50$ dB
Radiated Emission	Level Accuracy: Above 1000MHz	$\pm 4.20$ dB

## 1.8 Test Facility

The testing report were performed by the Shenzhen Toby Technology Co., Ltd., in their facilities located at 1/F., Building 6, Rundongsheng Industrial Zone, Longzhu, Xixiang, Bao'an District, Shenzhen, Guangdong, China. At the time of testing, the following bodies accredited the Laboratory:

### **CNAS (L5813)**

The Laboratory has been accredited by CNAS to ISO/IEC 17025: 2017 General Requirements for the Competence of Testing and Calibration Laboratories for the competence in the field of testing. And the Registration No.: CNAS L5813.

### **A2LA Certificate No.: 4750.01**

The laboratory has been accredited by American Association for Laboratory Accreditation(A2LA) to ISO/IEC 17025: 2017 General Requirements for the Competence of Testing and Calibration Laboratories for the technical competence in the field of Electrical Testing. And the A2LA Certificate No.: 4750.01.FCC Accredited Test Site Number: 854351. Designation Number: CN1223.

### **IC Registration No.: (11950A)**

The Laboratory has been registered by Certification and Engineering Bureau of Industry Canada for radio equipment testing. The site registration: Site# 11950A. CAB identifier: CN0056.

## 2. Test Summary

Standard Section		Test Item	Test Sample(s)	Judgment	Remark
FCC	IC				
FCC 15.207(a)	RSS-Gen 8.8	Conducted Emission	202204-0403-3-1#	PASS	N/A
FCC 15.209 & 15.247(d)	RSS-Gen 8.9 & RSS 247 5.5	Radiated Unwanted Emissions	202204-0403-3-1#	PASS	N/A
FCC 15.203	RSS-247 6.8	Antenna Requirement	202204-0403-3-2#	PASS	N/A
FCC 15.247(a)	RSS-Gen 6.7 RSS 247 5.1 (1)	99% Occupied Bandwidth & 20dB Bandwidth	202204-0403-3-2#	PASS	N/A
FCC 15.247(b)(1)	RSS 247 5.4 (2)	Peak Output Power	202204-0403-3-2#	PASS	N/A
FCC 15.247(a)(1)	RSS 247 5.1 (2)	Carrier frequency separation	202204-0403-3-2#	PASS	N/A
FCC 15.247(a)(1)	RSS 247 5.1 (4)	Time of occupancy	202204-0403-3-2#	PASS	N/A
FCC 15.247(b)(1)	RSS 247 5.1 (4)	Number of Hopping Frequency	202204-0403-3-2#	PASS	N/A
FCC 15.247(d)	RSS-Gen 8.10 RSS-247 5.5	Band Edge	202204-0403-3-2#	PASS	N/A
FCC 15.207(a)	RSS-247 5.5	Conducted Unwanted Emissions	202204-0403-3-2#	PASS	N/A
FCC 15.205	RSS-Gen 8.10	Emissions in Restricted Bands	202204-0403-3-2#	PASS	N/A
/	/	On Time and Duty Cycle	202204-0403-3-2#	/	N/A

**Note:** N/A is an abbreviation for Not Applicable.

## 3. Test Software

Test Item	Test Software	Manufacturer	Version No.
Conducted Emission	EZ-EMC	EZ	CDI-03A2
Radiation Emission	EZ-EMC	EZ	FA-03A2RE
Radiation Emission	EZ-EMC	EZ	FA-03A2RE+
RF Conducted Measurement	MTS-8310	MWRFtest	V2.0.0.0
RF Test System	JS1120	Tonscend	V2.6.88.0336

## 4. Test Equipment

Conducted Emission Test					
Equipment	Manufacturer	Model No.	Serial No.	Last Cal.	Cal. Due Date
EMI Test Receiver	Rohde & Schwarz	ESCI	100321	Jun. 23, 2022	Jun. 22, 2023
RF Switching Unit	Compliance Direction Systems Inc	RSU-A4	34403	Jun. 23, 2022	Jun. 22, 2023
AMN	SCHWARZBECK	NNBL 8226-2	8226-2/164	Jun. 22, 2022	Jun. 21, 2023
LISN	Rohde & Schwarz	ENV216	101131	Jun. 22, 2022	Jun. 21, 2023
Radiation Emission Test					
Equipment	Manufacturer	Model No.	Serial No.	Last Cal.	Cal. Due Date
Spectrum Analyzer	Rohde & Schwarz	FSV40-N	102197	Jun. 23, 2022	Jun. 22, 2023
MXA Signal Analyzer	Agilent	N9020A	MY47380425	Sep. 03, 2021	Sep. 02, 2022
EMI Test Receiver	Rohde & Schwarz	ESPI	100010/007	Jun. 23, 2022	Jun. 22, 2023
EMI Test Receiver	Rohde & Schwarz	ESU-8	100472	Feb. 26, 2022	Feb. 25, 2023
Bilog Antenna	ETS-LINDGREN	3142E	00117537	Feb. 27, 2022	Feb. 26, 2024
Bilog Antenna	SCHWARZBECK	VULB 9168	1225	Dec. 05, 2021	Dec. 04, 2023
Horn Antenna	ETS-LINDGREN	3117	00143207	Feb. 26, 2022	Feb. 25, 2024
Horn Antenna	SCHWARZBECK	BBHA 9120 D	2463	Feb. 26, 2022	Feb.25, 2024
Horn Antenna	SCHWARZBECK	BBHA 9170	1118	Feb. 26, 2022	Feb. 25, 2024
Loop Antenna	SCHWARZBECK	FMZB 1519 B	1519B-059	Feb. 26, 2022	Feb.25, 2024
Pre-amplifier	SONOMA	310N	185903	Feb. 26, 2022	Feb.25, 2023
Pre-amplifier	HP	8449B	3008A00849	Feb. 26, 2022	Feb.25, 2023
HF Amplifier	Tonscend	TAP9E6343	AP21C806117	Sep. 03, 2021	Sep. 02, 2022
HF Amplifier	Tonscend	TAP051845	AP21C806141	Sep. 03, 2021	Sep. 02, 2022
HF Amplifier	Tonscend	TAP0184050	AP21C806129	Sep. 03, 2021	Sep. 02, 2022
Antenna Conducted Emission					
Equipment	Manufacturer	Model No.	Serial No.	Last Cal.	Cal. Due Date
Spectrum Analyzer	Agilent	E4407B	MY45106456	Jun. 23, 2022	Jun. 22, 2023
Spectrum Analyzer	Rohde & Schwarz	FSV40-N	102197	Jun. 23, 2022	Jun. 22, 2023
MXA Signal Analyzer	Agilent	N9020A	MY49100060	Sep. 03, 2021	Sep. 02, 2022
Spectrum Analyzer	KEYSIGT	N9020B	MY60110172	Sep. 03, 2021	Sep. 02, 2022
RF Power Sensor	DARE!! Instruments	RadiPowerRPR3006W	17I00015SNO26	Sep. 03, 2021	Sep. 02, 2022
	DARE!! Instruments	RadiPowerRPR3006W	17I00015SNO29	Sep. 03, 2021	Sep. 02, 2022
	DARE!! Instruments	RadiPowerRPR3006W	17I00015SNO31	Sep. 03, 2021	Sep. 02, 2022
	DARE!! Instruments	RadiPowerRPR3006W	17I00015SNO33	Sep. 03, 2021	Sep. 02, 2022
RF Control Unit	Tonsced	JS0806-2	21F8060439	Sep. 03, 2021	Sep. 02, 2022

## 5. Conducted Emission

### 5.1 Test Standard and Limit

5.1.1 Test Standard  
**FCC Part 15.207**

5.1.2 Test Limit

Frequency	Maximum RF Line Voltage (dB $\mu$ V)	
	Quasi-peak Level	Average Level
150kHz~500kHz	66 ~ 56 *	56 ~ 46 *
500kHz~5MHz	56	46
5MHz~30MHz	60	50

**Notes:**

- (1) \*Decreasing linearly with logarithm of the frequency.
- (2) The lower limit shall apply at the transition frequencies.
- (3) The limit decrease in line with the logarithm of the frequency in the range of 0.15 to 0.50MHz.

### 5.2 Test Setup

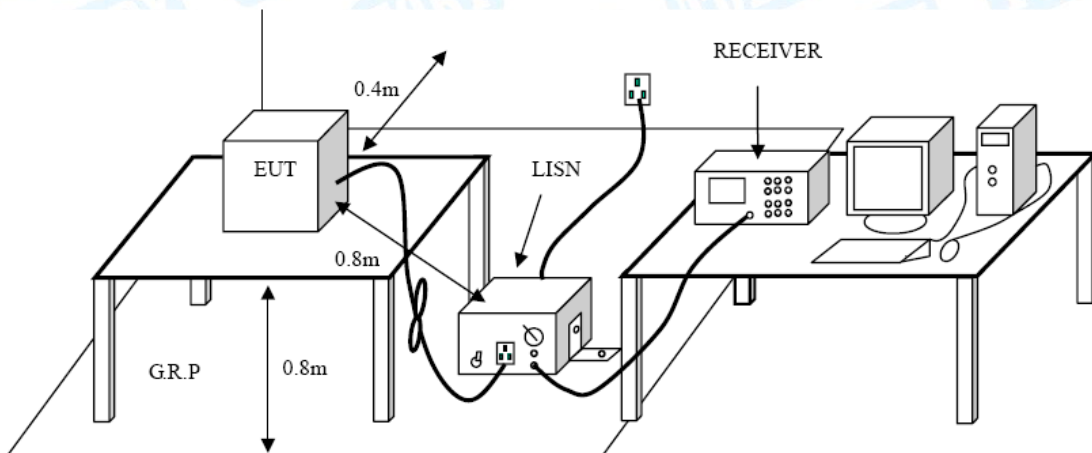

### 5.3 Test Procedure

- The EUT was placed 0.8 meters from the horizontal ground plane with EUT being connected to the power mains through a line impedance stabilization network (LISN). All other support equipments powered from additional LISN(s). The LISN provide 50 Ohm/50uH of coupling impedance for the measuring instrument.
- Interconnecting cables that hang closer than 40 cm to the ground plane shall be folded back and forth in the center forming a bundle 30 to 40 cm long.
- I/O cables that are not connected to a peripheral shall be bundled in the center. The end of the cable may be terminated, if required, using the correct terminating impedance. The overall length shall not exceed 1 m.
- LISN at least 80 cm from nearest part of EUT chassis.
- The bandwidth of EMI test receiver is set at 9 kHz, and the test frequency band is from 0.15MHz to 30MHz.

#### 5.4 Deviation From Test Standard

No deviation

#### 5.5 EUT Operating Mode

Please refer to the description of test mode.

#### 5.6 Test Data

Please refer to the Attachment A inside test report.

## 6. Radiated and Conducted Unwanted Emissions

### 6.1 Test Standard and Limit

#### 6.1.1 Test Standard

**FCC Part 15.209 & FCC Part 15.247(d)**

#### 6.1.2 Test Limit

General field strength limits at frequencies Below 30MHz		
Frequency (MHz)	Field Strength (microvolt/meter)**	Measurement Distance (meters)
0.009~0.490	2400/F(KHz)	300
0.490~1.705	24000/F(KHz)	30
1.705~30.0	30	30

**Note:** 1, The emission limits for the ranges 9-90 kHz and 110-490 kHz are based on measurements employing a linear average detector.

General field strength limits at frequencies above 30 MHz		
Frequency (MHz)	Field strength(μV/m at 3 m)	Measurement Distance (meters)
30~88	100	3
88~216	150	3
216~960	200	3
Above 960	500	3

General field strength limits at frequencies Above 1000MHz		
Frequency (MHz)	Distance of 3m (dBuV/m)	
	Peak	Average
Above 1000	74	54

**Note:**  
 (1) The tighter limit applies at the band edges.  
 (2) Emission Level(dBuV/m)=20log Emission Level(uV/m)

In any 100 kHz bandwidth outside the frequency band in which the spread spectrum or digitally modulated device is operating, the RF power that is produced shall be at least 20 dB below that in the 100 kHz bandwidth within the band that contains the highest level of the desired power, based on either an RF conducted or a radiated measurement, provided that the transmitter demonstrates compliance with the peak conducted power limits. If the transmitter complies with the conducted power limits based on the use of root-mean-square averaging over a time interval, as permitted under section 5.4(d), the attenuation required shall be 30 dB instead of 20 dB. Attenuation below the general field strength limits specified in RSS-Gen is not required.

### 6.2 Test Setup

#### Radiated measurement

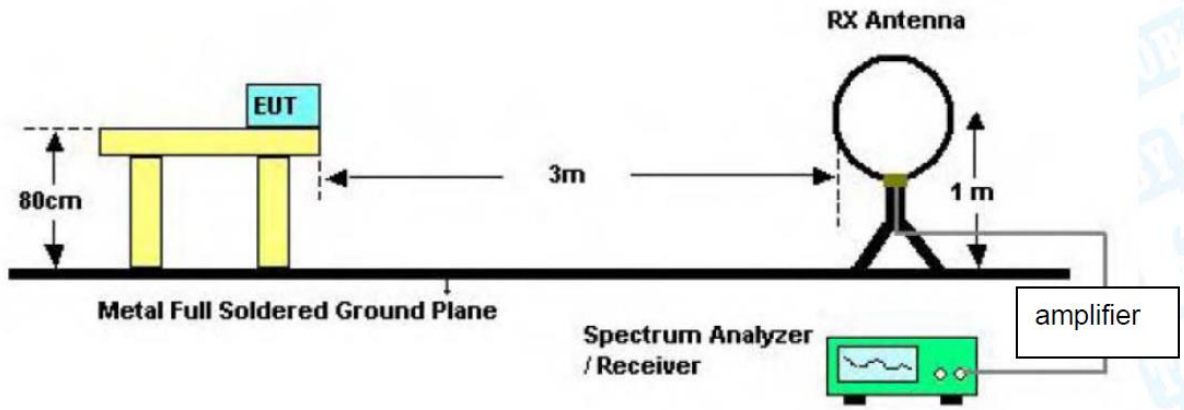

**Below 30MHz Test Setup**

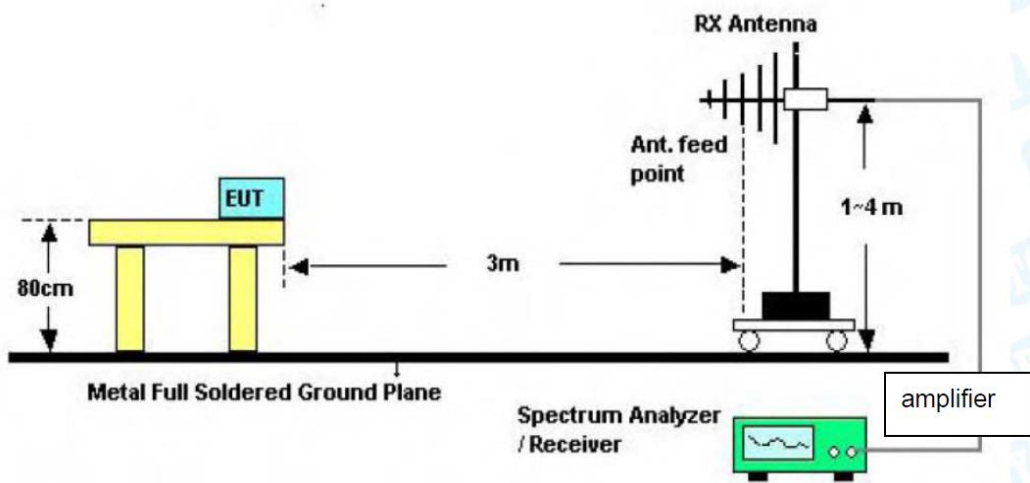

**Below 1000MHz Test Setup**

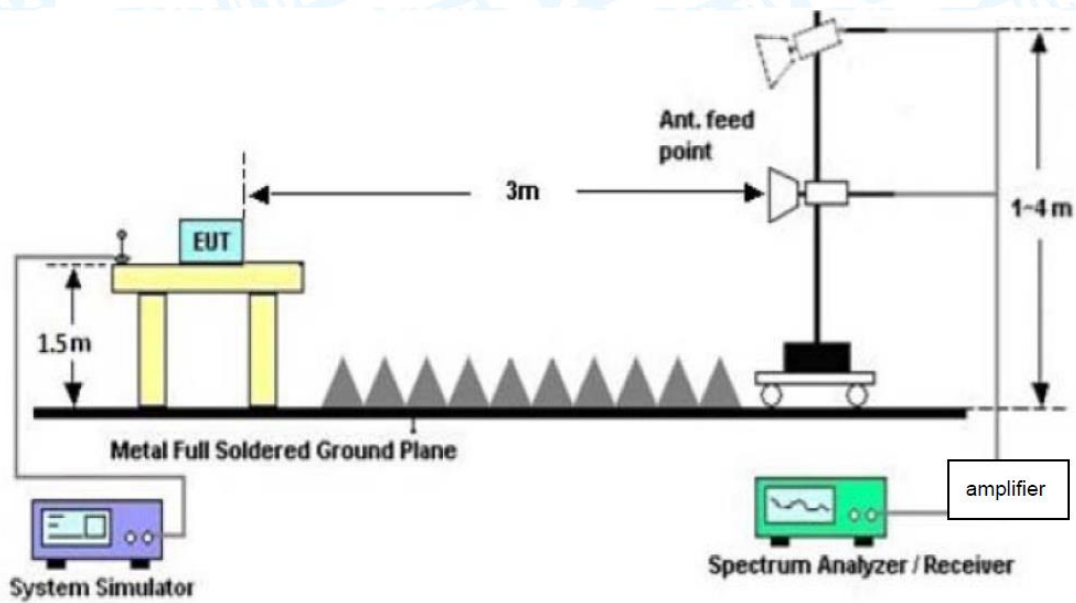

**Above 1GHz Test Setup  
Conducted measurement**



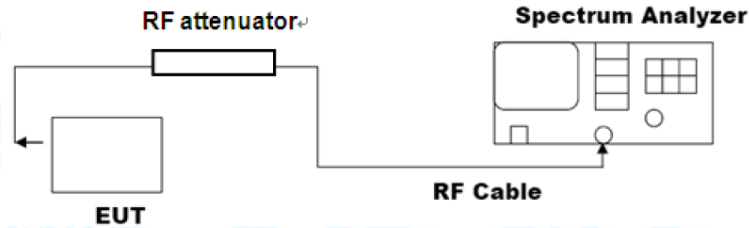

### 6.3 Test Procedure

#### ---Radiated measurement

- The measuring distance of 3m shall be used for measurements at frequency up to 1GHz and above 1 GHz. The EUT was placed on a rotating 0.8m high above ground, the table was rotated 360 degrees to determine the position of the highest radiation.
- Measurements at frequency above 1GHz. The EUT was placed on a rotating 1.5m high above the ground. RF absorbers covered the ground plane with a minimum area of 3.0m by 3.0m between the EUT and measurement receiver antenna. The RF absorber shall not exceed 30cm in high above the conducting floor. The table was rotated 360 degrees to determine the position of the highest radiation.
- The Test antenna shall vary between 1m and 4m, Both Horizontal and Vertical antenna are set to make measurement.
- The initial step in collecting conducted emission data is a spectrum analyzer peak detector mode pre-scanning the measurement frequency range. Significant peaks are then marked and then Quasi Peak detector mode re-measured.
- If the Peak Mode measured value compliance with and lower than Quasi Peak Mode Limit Below 1 GHz, the EUT shall be deemed to meet QP Limits and then no additional QP Mode measurement performed. But the Peak Value and average value both need to comply with applicable limit above 1 GHz.
- Testing frequency range 30MHz-1GHz the measuring instrument use VBW=120 kHz with Quasi-peak detection. Testing frequency range 9KHz-150Hz the measuring instrument use VBW=200Hz with Quasi-peak detection. Testing frequency range 9KHz-30MHz the measuring instrument use VBW=9kHz with Quasi-peak detection.
- Testing frequency range above 1GHz the measuring instrument use RBW=1 MHz and VBW=3 MHz with Peak Detector for Peak Values, and use RBW=1 MHz and VBW=10 Hz with Peak Detector for Average Values.
- For the actual test configuration, please see the test setup photo.

### --- Conducted measurement

#### ● Reference level measurement

Establish a reference level by using the following procedure:

- a) Set instrument center frequency to DTS channel center frequency.
- b) Set the span to  $\geq 1.5$  times the DTS bandwidth.
- c) Set the RBW = 100 kHz.
- d) Set the VBW  $\geq [3 \times \text{RBW}]$ .
- e) Detector = peak.
- f) Sweep time = auto couple.
- g) Trace mode = max hold.
- h) Allow trace to fully stabilize.
- i) Use the peak marker function to determine the maximum PSD level.

Note that the channel found to contain the maximum PSD level can be used to establish the reference level.

#### ● Emission level measurement

Establish an emission level by using the following procedure:

- a) Set the center frequency and span to encompass frequency range to be measured.
- b) Set the RBW = 100 kHz.
- c) Set the VBW  $\geq [3 \times \text{RBW}]$ .
- d) Detector = peak.
- e) Sweep time = auto couple.
- f) Trace mode = max hold.
- g) Allow trace to fully stabilize.
- h) Use the peak marker function to determine the maximum amplitude level.

Ensure that the amplitude of all unwanted emissions outside of the authorized frequency band (excluding restricted frequency bands) is attenuated by at least the minimum requirements specified in 11.11. Report the three highest emissions relative to the limit.

### 6.4 Deviation From Test Standard

No deviation

### 6.5 EUT Operating Mode

Please refer to the description of test mode.

### 6.6 Test Data

Radiated measurement please refer to the Attachment B inside test report.

Conducted measurement please refer to the external appendix report of BT.

## 7. Emissions in Restricted Bands

### 7.1 Test Standard and Limit

#### 7.1.1 Test Standard

**FCC Part 15.205 & FCC Part 15.247(d)**

#### 7.1.2 Test Limit

Restricted Frequency Band (MHz)	Distance Meters(at 3m)	
	Peak (dBuV/m)	Average (dBuV/m)
2310 ~2390	74	54
2483.5 ~2500	74	54
	Peak (dBm) <sub>see 7.3 e)</sub>	Average (dBm) <sub>see 7.3 e)</sub>
2310 ~2390	-21.20	-41.20
2483.5 ~2500	-21.20	-41.20

Note: According the ANSI C63.10 11.12.2 antenna-port conducted measurements may also be used as an alternative to radiated measurements for determining compliance in the restricted frequency bands requirements. If conducted measurements are performed, then proper impedance matching must be ensured and an additional radiated test forcabinet/case emissions is required.

### 7.2 Test Setup

#### Radiated measurement

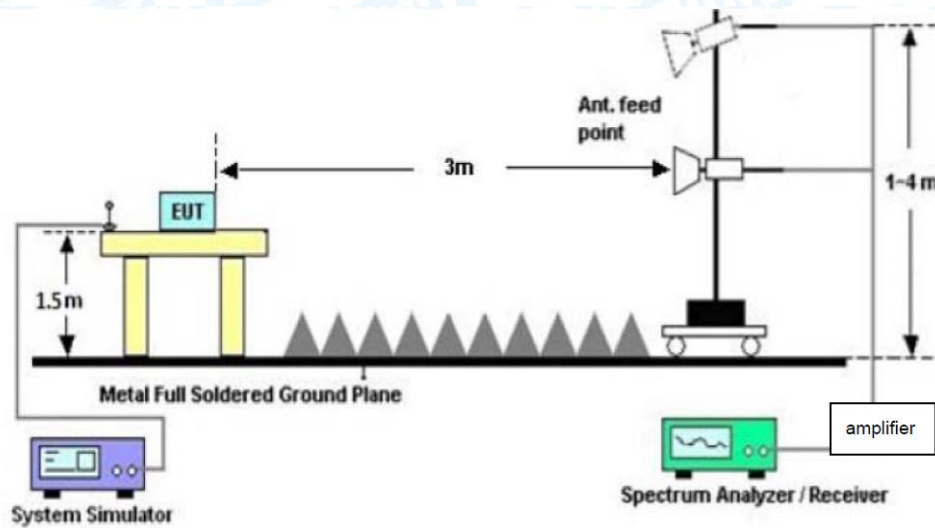

#### Conducted measurement

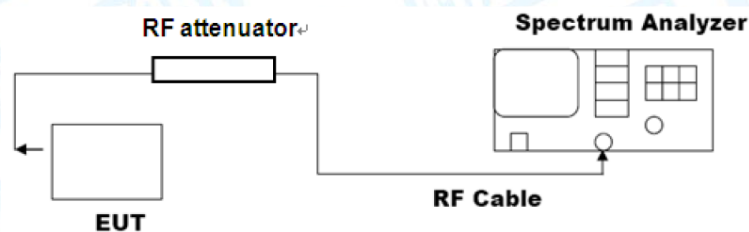

## 7.3 Test Procedure

### ---Radiated measurement

- Measurements at frequency above 1GHz. The EUT was placed on a rotating 1.5m high above the ground. RF absorbers covered the ground plane with a minimum area of 3.0m by 3.0m between the EUT and measurement receiver antenna. The RF absorber shall not exceed 30cm in high above the conducting floor. The table was rotated 360 degrees to determine the position of the highest radiation.
- The Test antenna shall vary between 1m and 4m, Both Horizontal and Vertical antenna are set to make measurement.
- The initial step in collecting conducted emission data is a spectrum analyzer peak detector mode pre-scanning the measurement frequency range. Significant peaks are then marked and then Quasi Peak detector mode re-measured.
- The Peak Value and average value both need to comply with applicable limit above 1 GHz.
- Testing frequency range above 1GHz the measuring instrument use RBW=1 MHz and VBW=3 MHz with Peak Detector for Peak Values, and use RBW=1 MHz and VBW=10 Hz with Peak Detector for Average Values.
- For the actual test configuration, please see the test setup photo.

### --- Conducted measurement

- a) Measure the conducted output power (in dBm) using the detector specified by the appropriate regulatory agency (see 11.12.2.3 through 11.12.2.5 for guidance regarding measurement procedures for determining quasi-peak, peak, and average conducted output power, respectively).
- b) Add the maximum transmit antenna gain (in dBi) to the measured output power level to determine the EIRP (see 11.12.2.6 for guidance on determining the applicable antenna gain).
- c) Add the appropriate maximum ground reflection factor to the EIRP (6 dB for frequencies  $\leq 30$  MHz; 4.7 dB for frequencies between 30 MHz and 1000 MHz, inclusive; and 0 dB for frequencies  $> 1000$  MHz).
- d) For MIMO devices, measure the power of each chain and sum the EIRP of all chains in linear terms (i.e., watts and mW).
- e) Convert the resultant EIRP to an equivalent electric field strength using the following relationship:

$$E = \text{EIRP} - 20 \log d + 104.8$$

where

$E$  is the electric field strength in dBuV/m

EIRP is the equivalent isotropically radiated power in dBm

$d$  is the specified measurement distance in m

- f) Compare the resultant electric field strength level with the applicable regulatory limit.
- g) Perform the radiated spurious emission test.

## 7.4 Deviation From Test Standard

No deviation

## 7.5 EUT Operating Mode

Please refer to the description of test mode.

## 7.6 Test Data

Remark: The test uses antenna-port conducted measurements as an alternative to radiated measurements for determining compliance in the restricted frequency bands requirements.

Please refer to the external appendix report of BT.

## 8. 99% Occupied and 20dB Bandwidth

### 8.1 Test Standard and Limit

#### 8.1.1 Test Standard

**FCC Part 15.205 & FCC Part 15.247(a)**

#### 8.1.2 Test Limit

For an FHSS system operating in the 2400 to 2483.5 MHz band, there are no limits for 20dB bandwidth and 99% occupied bandwidth.

### 8.2 Test Setup

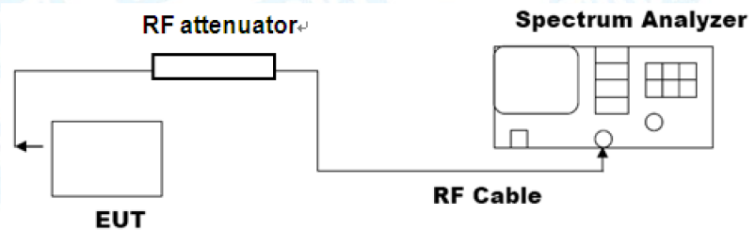

### 8.3 Test Procedure

● The occupied bandwidth is the frequency bandwidth such that, below its lower and above its upper frequency limits, the mean powers are each equal to 0.5% of the total mean power of the given emission. The following procedure shall be used for measuring 99% power bandwidth:

- The instrument center frequency is set to the nominal EUT channel center frequency. The frequency span for the spectrum analyzer shall be between 1.5 times and 5.0 times the OBW.
- The nominal IF filter bandwidth (3 dB RBW) shall be in the range of 1% to 5% of the OBW, and VBW shall be approximately three times the RBW, unless otherwise specified by the applicable requirement.
- Set the reference level of the instrument as required, keeping the signal from exceeding the maximum input mixer level for linear operation. In general, the peak of the spectral envelope shall be more than  $[10 \log (\text{OBW}/\text{RBW})]$  below the reference level. Specific guidance is given in 4.1.5.2.
- Step a) through step c) might require iteration to adjust within the specified range.
- Video averaging is not permitted. Where practical, a sample detection and single sweep mode shall be used. Otherwise, peak detection and max hold mode (until the trace stabilizes) shall be used.
- Use the 99% power bandwidth function of the instrument (if available) and report the measured bandwidth.
- If the instrument does not have a 99% power bandwidth function, then the trace data points are recovered and directly summed in linear power terms. The recovered amplitude data points, beginning at the lowest frequency, are placed in a running sum until 0.5% of the total is reached; that frequency is recorded as the lower frequency. The process is repeated until 99.5% of the total is reached; that frequency is recorded as the upper frequency. The 99% power bandwidth is the difference between these two frequencies.

---

h) The occupied bandwidth shall be reported by providing plot(s) of the measuring instrument display; the plot axes and the scale units per division shall be clearly labeled. Tabular data may be reported in addition to the plot(s).

#### 8.4 Deviation From Test Standard

No deviation

#### 8.5 EUT Operating Mode

Please refer to the description of test mode.

#### 8.6 Test Data

Please refer to the external appendix report of BT.

## 9. Peak Output Power Test

### 9.1 Test Standard and Limit

#### 9.1.1 Test Standard

**FCC Part 15.247(b)(1)**

#### 9.1.2 Test Limit

Test Item	Limit	Frequency Range(MHz)
Peak Output Power	$P_{max-pk} \leq 1\text{ W}$ $N_{ch} \geq 75$ $f \geq \text{MAX} \{ 25\text{ kHz}, BW_{20dB} \}$ max. $BW_{20dB}$ not specified $t_{ch} \leq 0.4\text{ s}$ for $T = 0.4 * N_{ch}$	2400~2483.5
	$P_{max-pk} \leq 0.125\text{ W}$ $N_{ch} \geq 15$ $f \geq [ \text{MAX}\{25\text{ kHz}, 0.67 * BW_{20dB}\}$ OR $\text{MAX}\{25\text{ kHz}, BW_{20dB}\} ]$ max. $BW_{20dB}$ not specified $t_{ch} \leq 0.4\text{ s}$ for $T = 0.4 * N_{ch}$	
$t_{ch}$ = average time of occupancy; $T$ = period; $N_{ch}$ = # hopping frequencies; $BW$ = bandwidth; $f$ = hopping channel carrier frequency separation		

### 9.2 Test Setup

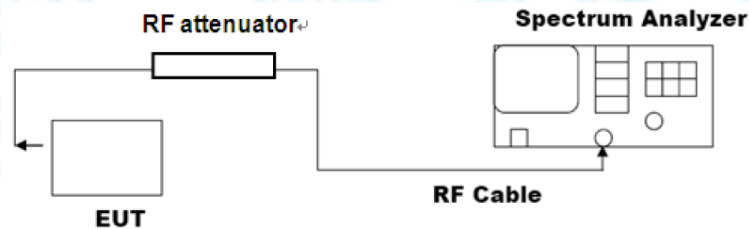

### 9.3 Test Procedure

- This is an RF-conducted test to evaluate maximum peak output power. Use a direct connection between the antenna port of the unlicensed wireless device and the spectrum analyzer, through suitable attenuation. The hopping shall be disabled for this test:
  - a) Use the following spectrum analyzer settings:
    - 1) Span: Approximately five times the 20 dB bandwidth, centered on a hopping channel.
    - 2) RBW > 20 dB bandwidth of the emission being measured.
    - 3) VBW ≥ RBW.
    - 4) Sweep: Auto.
    - 5) Detector function: Peak.
    - 6) Trace: Max hold.
  - b) Allow trace to stabilize.
  - c) Use the marker-to-peak function to set the marker to the peak of the emission.
  - d) The indicated level is the peak output power, after any corrections for external



attenuators and cables.

e) A plot of the test results and setup description shall be included in the test report.

NOTE-A peak responding power meter may be used, where the power meter and sensor system video bandwidth is greater than the occupied bandwidth of the unlicensed wireless device, rather than a spectrum analyzer.

#### 9.4 Deviation From Test Standard

No deviation

#### 9.5 EUT Operating Mode

Please refer to the description of test mode.

#### 9.6 Test Data

Please refer to the external appendix report of BT.

## 10. Carrier frequency separation

### 10.1 Test Standard and Limit

#### 10.1.1 Test Standard

#### FCC Part 15.247(a)(1)

#### 10.1.2 Test Limit

Test Item	Limit	Frequency Range(MHz)
Carrier frequency separation	$P_{\max\text{-pk}} \leq 1 \text{ W}$ $N_{\text{ch}} \geq 75$ $f \geq \text{MAX} \{ 25 \text{ kHz}, \text{BW}_{20\text{dB}} \}$ max. $\text{BW}_{20\text{dB}}$ not specified $t_{\text{ch}} \leq 0.4 \text{ s}$ for $T = 0.4 * N_{\text{ch}}$	2400~2483.5
	$P_{\max\text{-pk}} \leq 0.125 \text{ W}$ $N_{\text{ch}} \geq 15$ $f \geq [ \text{MAX}\{25 \text{ kHz}, 0.67 * \text{BW}_{20\text{dB}}\} ]$ OR $\text{MAX}\{25 \text{ kHz}, \text{BW}_{20\text{dB}}\}$ ] max. $\text{BW}_{20\text{dB}}$ not specified $t_{\text{ch}} \leq 0.4 \text{ s}$ for $T = 0.4 * N_{\text{ch}}$	
$t_{\text{ch}}$ = average time of occupancy; $T$ = period; $N_{\text{ch}}$ = # hopping frequencies; $\text{BW}$ = bandwidth; $f$ = hopping channel carrier frequency separation		

### 10.2 Test Setup

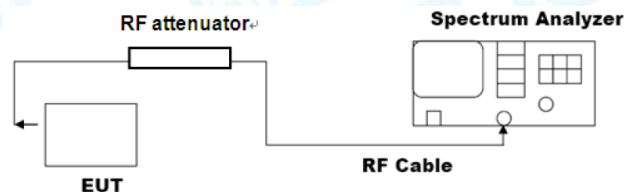

### 10.3 Test Procedure

● The EUT shall have its hopping function enabled. Use the following spectrum analyzer settings:

- Span: Wide enough to capture the peaks of two adjacent channels.
- RBW: Start with the RBW set to approximately 30% of the channel spacing; adjust as necessary to best identify the center of each individual channel.
- Video (or average) bandwidth (VBW)  $\geq$  RBW.
- Sweep: Auto.
- Detector function: Peak.
- Trace: Max hold.
- Allow the trace to stabilize.

Use the marker-delta function to determine the separation between the peaks of the adjacent channels.

Compliance of an EUT with the appropriate regulatory limit shall be determined. A plot of the data shall be included in the test report.

#### 10.4 Deviation From Test Standard

No deviation

#### 10.5 Antenna Connected Construction

Please refer to the description of test mode.

#### 10.6 Test Data

Please refer to the external appendix report of BT.

## 11. Time of occupancy (dwell time)

### 11.1 Test Standard and Limit

#### 11.1.1 Test Standard

#### FCC Part 15.247(a)(1)

#### 11.1.2 Test Limit

Test Item	Limit	Frequency Range(MHz)
Time of occupancy (dwell time)	$P_{max-pk} \leq 1\text{ W}$ $N_{ch} \geq 75$ $f \geq \text{MAX} \{ 25\text{ kHz}, BW_{20dB} \}$ max. $BW_{20dB}$ not specified $t_{ch} \leq 0.4\text{ s}$ for $T = 0.4 * N_{ch}$	2400~2483.5
	$P_{max-pk} \leq 0.125\text{ W}$ $N_{ch} \geq 15$ $f \geq [ \text{MAX}\{25\text{ kHz}, 0.67 * BW_{20dB}\} ]$ OR $\text{MAX}\{25\text{ kHz}, BW_{20dB}\}$ ] max. $BW_{20dB}$ not specified $t_{ch} \leq 0.4\text{ s}$ for $T = 0.4 * N_{ch}$	
$t_{ch}$ = average time of occupancy; $T$ = period; $N_{ch}$ = # hopping frequencies; $BW$ = bandwidth; $f$ = hopping channel carrier frequency separation		

### 11.2 Test Setup

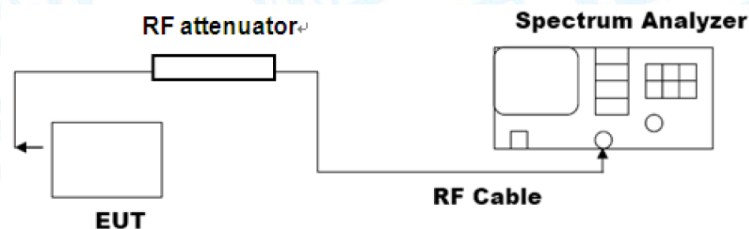

### 11.3 Test Procedure

- The EUT shall have its hopping function enabled. Use the following spectrum analyzer settings:
  - a) Span: Zero span, centered on a hopping channel.
  - b) RBW shall be  $\square$  channel spacing and where possible RBW should be set  $\gg 1 / T$ , where  $T$  is the expected dwell time per channel.
  - c) Sweep: As necessary to capture the entire dwell time per hopping channel; where possible use a video trigger and trigger delay so that the transmitted signal starts a little to the right of the start of the plot. The trigger level might need slight adjustment to prevent triggering when the system hops on an adjacent channel; a second plot might be needed with a longer sweep time to show two successive hops on a channel.
  - d) Detector function: Peak.
  - e) Trace: Max hold.
 Use the marker-delta function to determine the transmit time per hop. If this value varies

with different modes of operation (data rate, modulation format, number of hopping channels, etc.), then repeat this test for each variation in transmit time.

Repeat the measurement using a longer sweep time to determine the number of hops over the period specified in the requirements. The sweep time shall be equal to, or less than, the period specified in the requirements. Determine the number of hops over the sweep time and calculate the total number of hops in the period specified in the requirements, using the following equation:

$$\text{(Number of hops in the period specified in the requirements)} = \text{(number of hops on spectrum analyzer)} \times \text{(period specified in the requirements / analyzer sweep time)}$$

The average time of occupancy is calculated from the transmit time per hop multiplied by the number of hops in the period specified in the requirements. If the number of hops in a specific time varies with different modes of operation (data rate, modulation format, number of hopping channels, etc.), then repeat this test for each variation.

The measured transmit time and time between hops shall be consistent with the values described in the operational description for the EUT.

#### 11.4 Deviation From Test Standard

No deviation

#### 11.5 Antenna Connected Construction

Please refer to the description of test mode.

#### 11.6 Test Data

Please refer to the external appendix report of BT.

## 12. Number of hopping frequencies

### 12.1 Test Standard and Limit

#### 12.1.1 Test Standard

#### FCC Part 15.247(b)(1)

#### 12.1.2 Test Limit

Test Item	Limit	Frequency Range(MHz)
Carrier frequency separation	$P_{max-pk} \leq 1 \text{ W}$ $N_{ch} \geq 75$ $f \geq \text{MAX} \{ 25 \text{ kHz}, BW_{20dB} \}$ max. $BW_{20dB}$ not specified $t_{ch} \leq 0.4 \text{ s}$ for $T = 0.4 * N_{ch}$	2400~2483.5
	$P_{max-pk} \leq 0.125 \text{ W}$ $N_{ch} \geq 15$ $f \geq [ \text{MAX}\{25 \text{ kHz}, 0.67 * BW_{20dB}\}$ OR $\text{MAX}\{25 \text{ kHz}, BW_{20dB}\} ]$ max. $BW_{20dB}$ not specified $t_{ch} \leq 0.4 \text{ s}$ for $T = 0.4 * N_{ch}$	
$t_{ch}$ = average time of occupancy; $T$ = period; $N_{ch}$ = # hopping frequencies; $BW$ = bandwidth; $f$ = hopping channel carrier frequency separation		

### 12.2 Test Setup

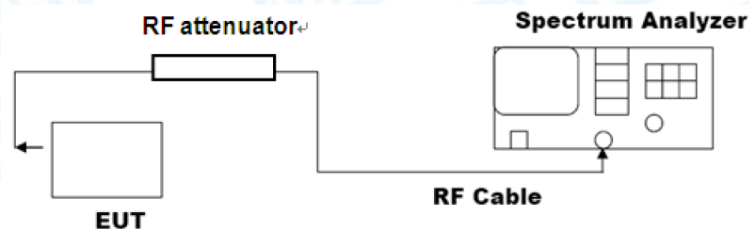

### 12.3 Test Procedure

● The EUT shall have its hopping function enabled. Use the following spectrum analyzer settings:

- Span: The frequency band of operation. Depending on the number of channels the device supports, it may be necessary to divide the frequency range of operation across multiple spans, to allow the individual channels to be clearly seen.
- RBW: To identify clearly the individual channels, set the RBW to less than 30% of the channel spacing or the 20 dB bandwidth, whichever is smaller.
- VBW  $\geq$  RBW.
- Sweep: Auto.
- Detector function: Peak.
- Trace: Max hold.
- Allow the trace to stabilize.

It might prove necessary to break the span up into subranges to show clearly all of the

hopping frequencies.

Compliance of an EUT with the appropriate regulatory limit shall be determined for the number of hopping channels. A plot of the data shall be included in the test report.

#### 12.4 Deviation From Test Standard

No deviation

#### 12.5 Antenna Connected Construction

Please refer to the description of test mode.

#### 12.6 Test Data

Please refer to the external appendix report of BT.

### 13. Antenna Requirement

#### 13.1 Test Standard and Limit

##### 11.1.1 Test Standard

**FCC Part 15.203**

##### 11.1.2 Requirement

An intentional radiator shall be designed to ensure that no antenna other than that furnished by the responsible party shall be used with the device. The use of a permanently attached antenna or of an antenna that uses a unique coupling to the intentional radiator shall be considered sufficient to comply with the provisions of this Section. The manufacturer may design the unit so that a broken antenna can be replaced by the user, but the use of a standard antenna jack or electrical connector is prohibited.

#### 13.2 Deviation From Test Standard

No deviation

#### 13.3 Antenna Connected Construction

The gains of the antenna used for transmitting is 0.5dBi, and the antenna de-signed with permanent attachment and no consideration of replacement. Please see the EUT photo for details.

#### 13.4 Test Data

The EUT antenna is a PCB Antenna. It complies with the standard requirement.

Antenna Type
<input checked="" type="checkbox"/> Permanent attached antenna
<input type="checkbox"/> Unique connector antenna
<input type="checkbox"/> Professional installation antenna



## 14. Photographs-Constructional Details

**Photo 1 Appearance of EUT**

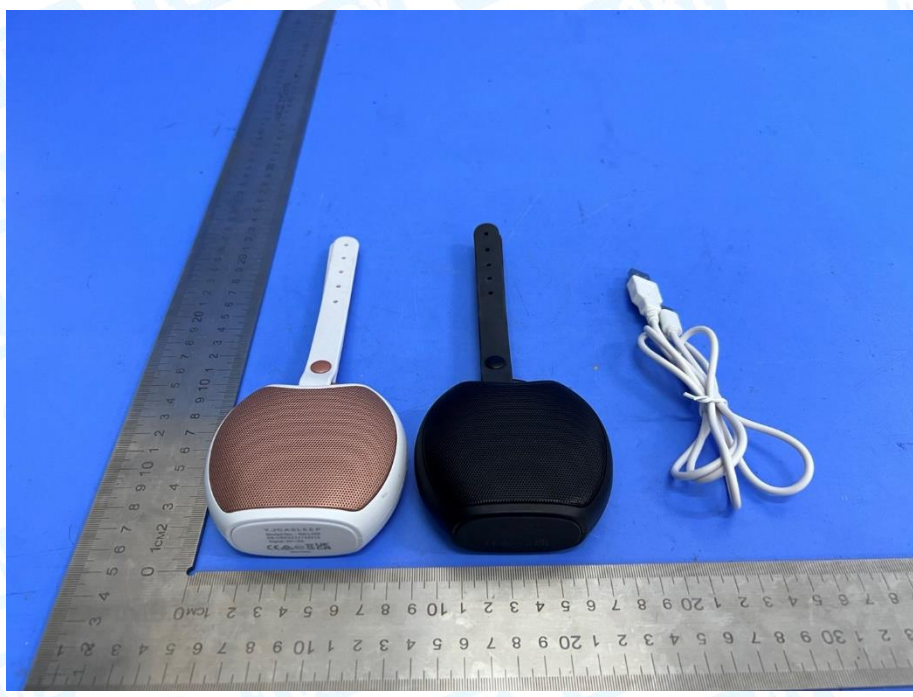

**Photo 2 Appearance of EUT**

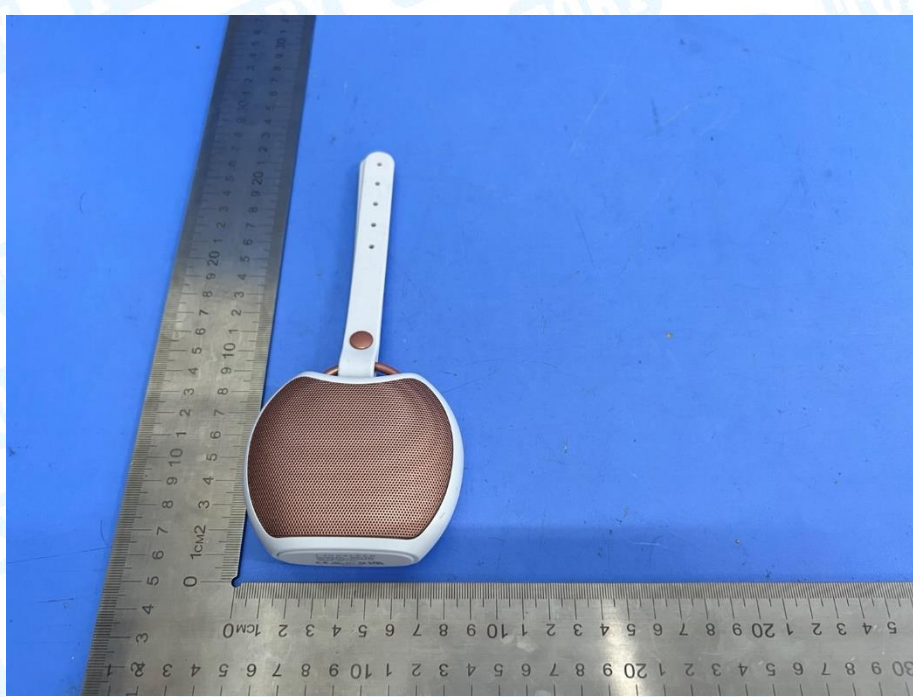

**Photo 3 Appearance of EUT**



**Photo 4 Appearance of EUT**

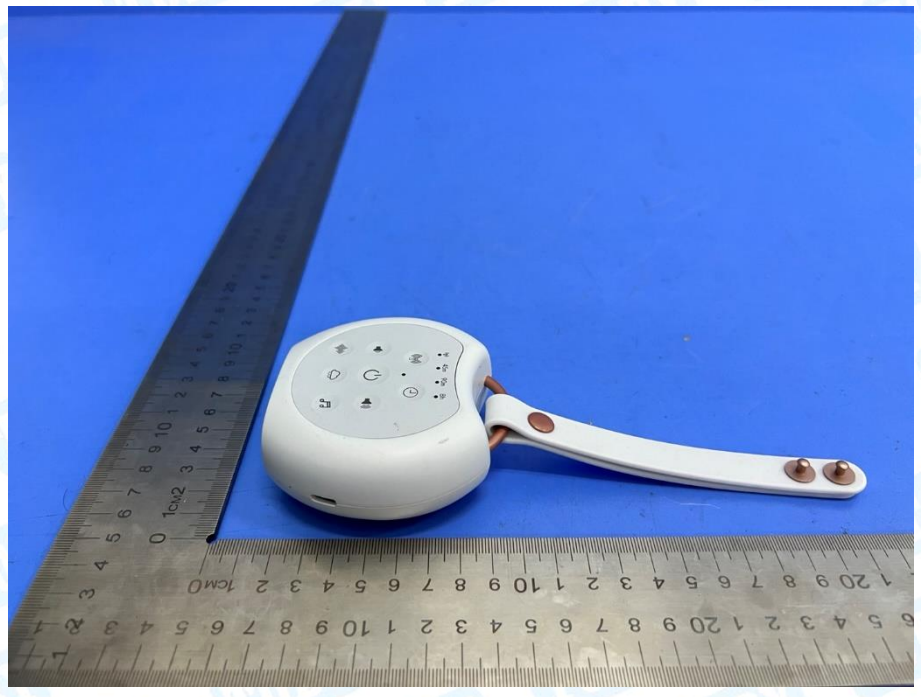

**Photo 5 Appearance of EUT**

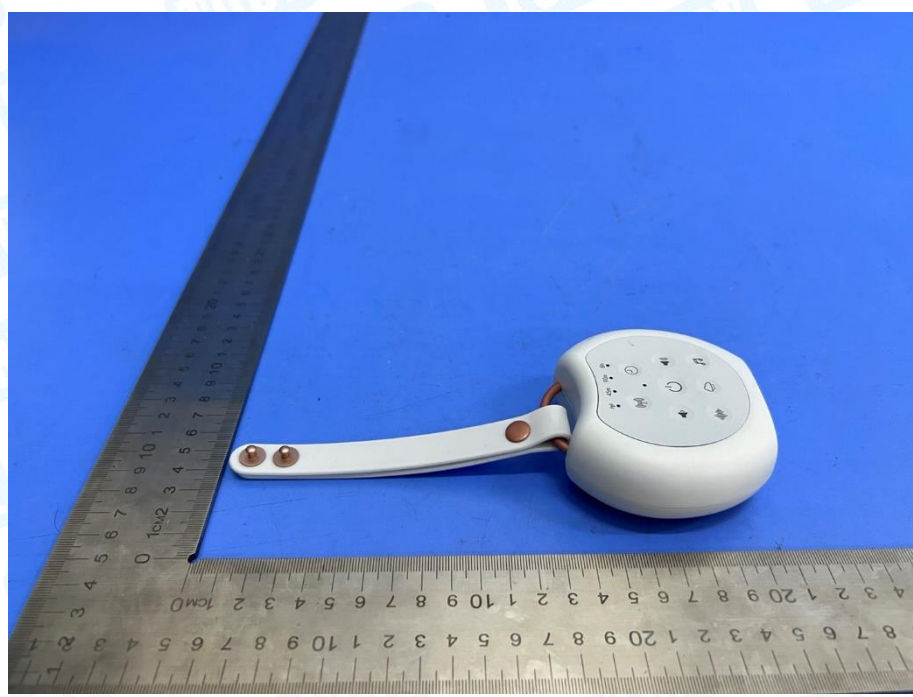

**Photo 6 Internal of EUT**

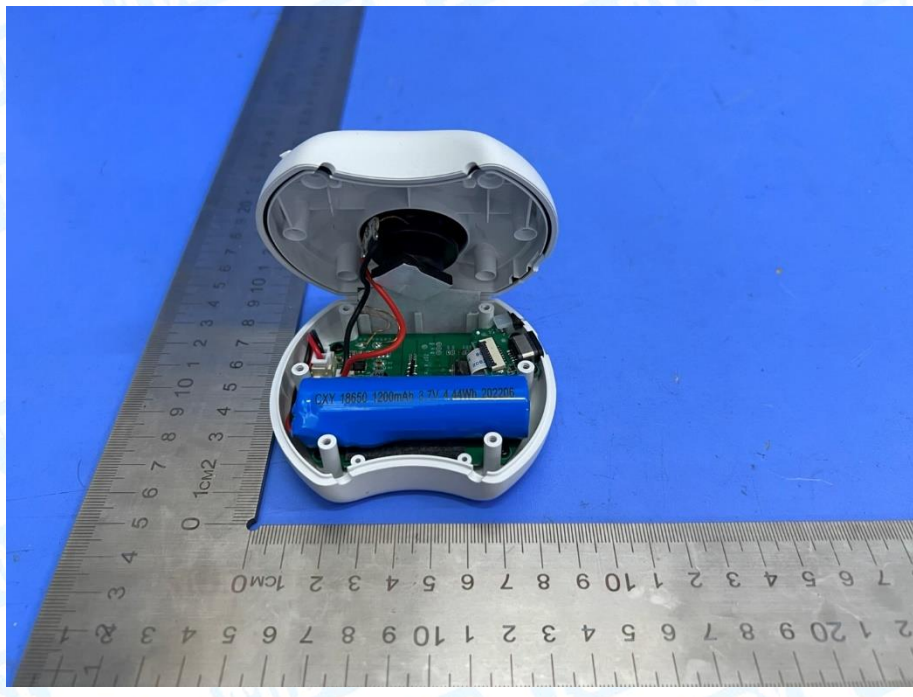

**Photo 7 Appearance of PCB**

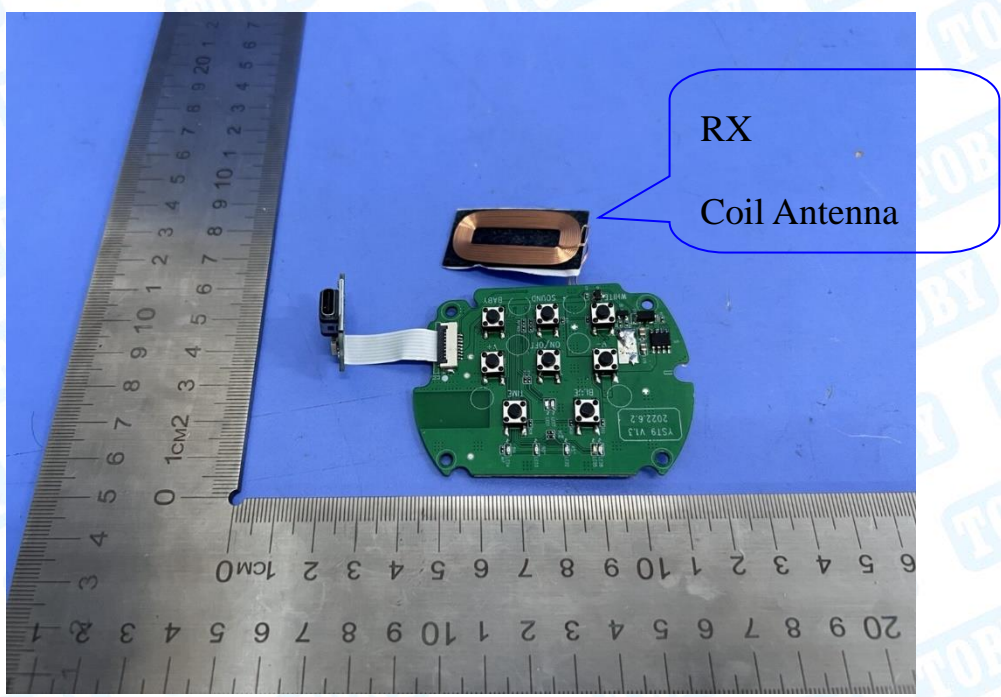

**Photo 8 Appearance of PCB**

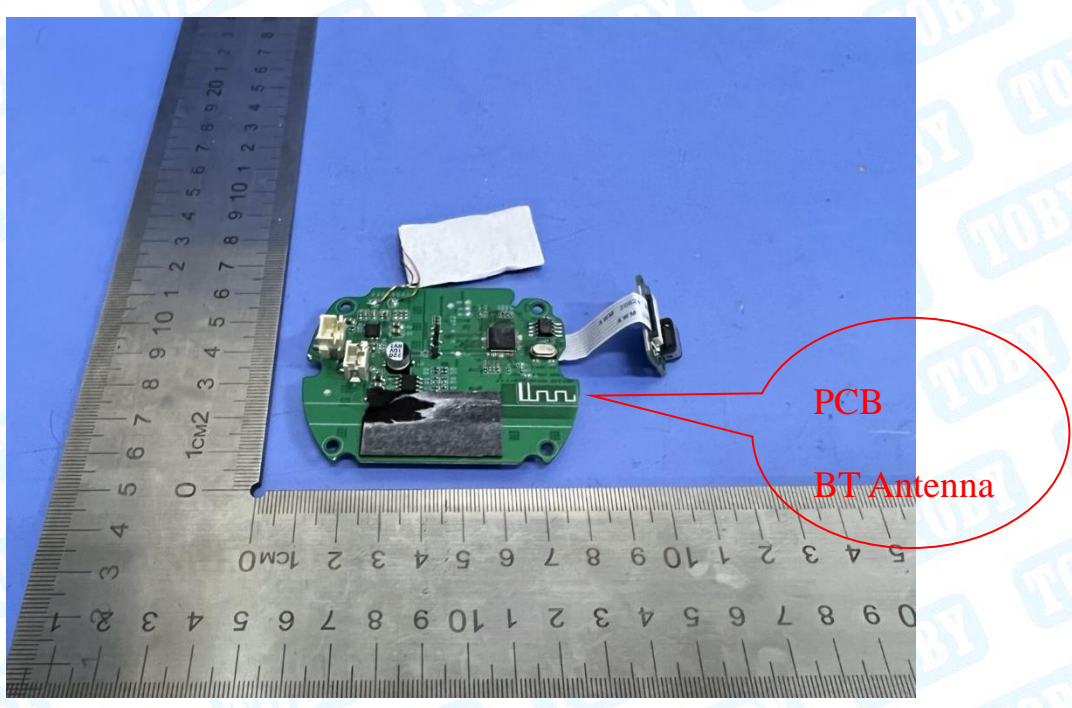

## 15. Photographs-Test Setup

Photo of Setup for Radiated Emission (Above 1 GHz)



Photo of Setup for Radiated Emission (Below 1 GHz)



**Photo of Setup for Conducted Emission**

## Attachment A-- Conducted Emission Test Data

Temperature:	24.4°C	Relative Humidity:	44%
Test Voltage:	AC 120V/60Hz		
Terminal:	Line		
Test Mode:	Mode 1		
Remark:	Only worse case is reported.		

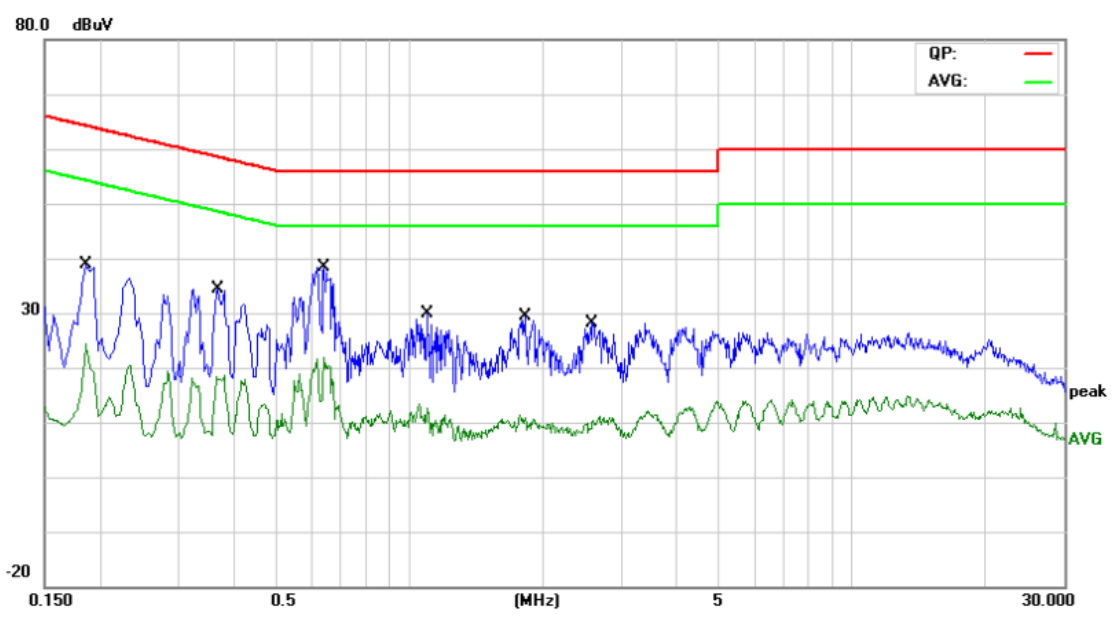

No.	Mk.	Freq. MHz	Reading Level dBuV	Correct Factor dB	Measure- ment dBuV	Limit dBuV	Over dB	Detector
1		0.1860	24.66	11.03	35.69	64.21	-28.52	QP
2		0.1860	8.51	11.03	19.54	54.21	-34.67	AVG
3		0.3700	18.16	10.88	29.04	58.50	-29.46	QP
4		0.3700	5.73	10.88	16.61	48.50	-31.89	AVG
5	*	0.6419	22.56	10.90	33.46	56.00	-22.54	QP
6		0.6419	7.87	10.90	18.77	46.00	-27.23	AVG
7		1.0980	11.15	10.66	21.81	56.00	-34.19	QP
8		1.0980	0.73	10.66	11.39	46.00	-34.61	AVG
9		1.8220	9.47	10.53	20.00	56.00	-36.00	QP
10		1.8220	-1.22	10.53	9.31	46.00	-36.69	AVG
11		2.5820	8.93	10.32	19.25	56.00	-36.75	QP
12		2.5820	-1.97	10.32	8.35	46.00	-37.65	AVG

Remark:  
 1. Corr. Factor (dB) = LISN Factor (dB) + Cable Loss (dB)  
 2. Margin (dB) = QuasiPeak/Average (dBuV) - Limit (dBuV)

<b>Temperature:</b>	24.4°C	<b>Relative Humidity:</b>	44%
<b>Test Voltage:</b>	AC 120V/60Hz		
<b>Terminal:</b>	Neutral		
<b>Test Mode:</b>	Mode 1		
<b>Remark:</b>	Only worse case is reported.		

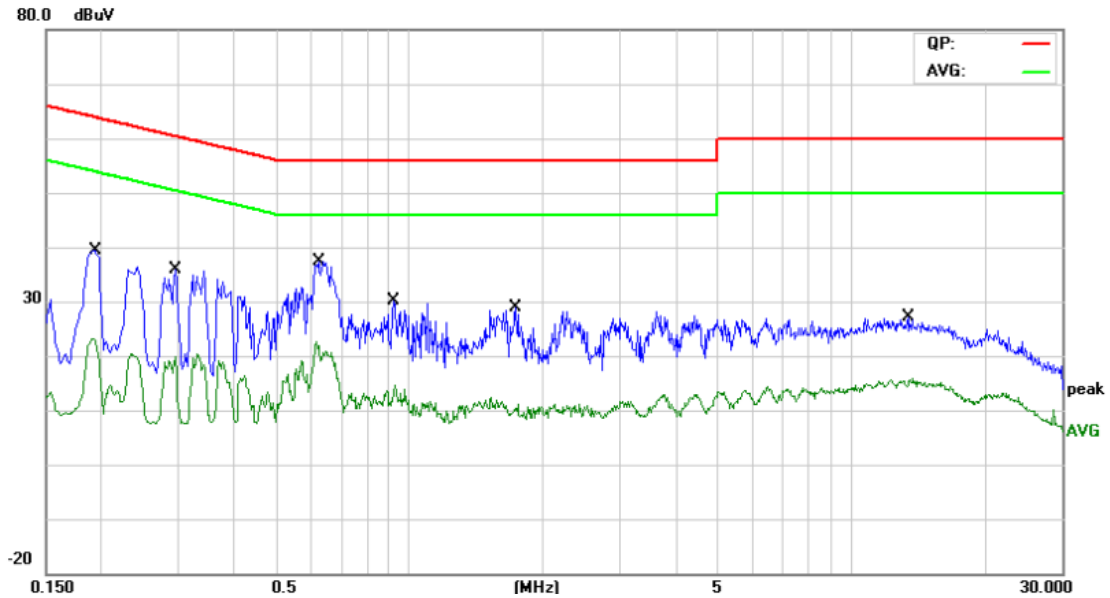

No.	Mk.	Freq. MHz	Reading Level dBuV	Correct Factor dB	Measure- ment dBuV	Limit dBuV	Over dB	Detector
1		0.1940	23.18	11.10	34.28	63.86	-29.58	QP
2		0.1940	5.54	11.10	16.64	53.86	-37.22	AVG
3		0.2940	8.87	10.98	19.85	60.41	-40.56	QP
4		0.2940	-2.78	10.98	8.20	50.41	-42.21	AVG
5	*	0.6220	23.33	10.89	34.22	56.00	-21.78	QP
6		0.6220	9.60	10.89	20.49	46.00	-25.51	AVG
7		0.9220	6.54	10.74	17.28	56.00	-38.72	QP
8		0.9220	-1.99	10.74	8.75	46.00	-37.25	AVG
9		1.7420	11.40	10.58	21.98	56.00	-34.02	QP
10		1.7420	-1.08	10.58	9.50	46.00	-36.50	AVG
11		13.4660	9.67	10.31	19.98	60.00	-40.02	QP
12		13.4660	4.02	10.31	14.33	50.00	-35.67	AVG

**Remark:**  
 1. Corr. Factor (dB) = LISN Factor (dB) + Cable Loss (dB)  
 2. Margin (dB) = QuasiPeak/Average (dBuV) - Limit (dBuV)



## Attachment B--Unwanted Emissions Data

### ---Radiated Unwanted Emissions

#### 9 KHz~30 MHz

From 9 KHz to 30 MHz: Conclusion: PASS

Note: The amplitude of spurious emissions which are attenuated by more than 20dB Below the permissible value has no need to be reported.

#### 30MHz~1GHz

Temperature:	23.5°C	Relative Humidity:	46%
Test Voltage:	AC 120V/60Hz		
Ant. Pol.	Horizontal		
Test Mode:	Mode 2		
Remark:	Only worse case is reported.		

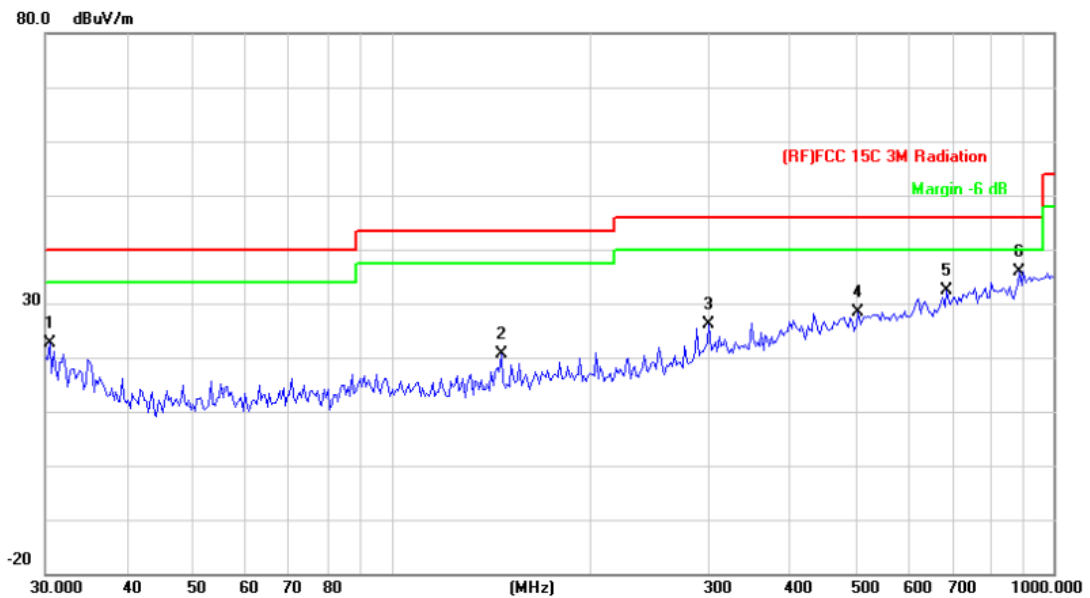

No.	Mk.	Freq. MHz	Reading Level dBuV	Correct Factor dB/m	Measure- ment dBuV/m	Limit dBuV/m	Over dB	Detector
1		30.4238	31.27	-8.75	22.52	40.00	-17.48	peak
2		146.3735	35.09	-14.39	20.70	43.50	-22.80	peak
3		301.4224	34.23	-8.10	26.13	46.00	-19.87	peak
4		506.4791	32.52	-4.15	28.37	46.00	-17.63	peak
5		689.5644	32.67	-0.23	32.44	46.00	-13.56	peak
6	*	887.6099	33.84	2.08	35.92	46.00	-10.08	peak

\*:Maximum data    x:Over limit    !:over margin

**Remark:**

1. Corr. = Antenna Factor (dB/m) + Cable Loss (dB)
2. QuasiPeak (dBμV/m)= Corr. (dB/m)+ Read Level (dBμV)
3. Margin (dB) = QuasiPeak (dBμV/m)-Limit QPK(dBμV/m)

<b>Temperature:</b>	23.5°C	<b>Relative Humidity:</b>	46%
<b>Test Voltage:</b>	AC 120V/60Hz		
<b>Ant. Pol.</b>	Vertical		
<b>Test Mode:</b>	Mode 2		
<b>Remark:</b>	Only worse case is reported.		

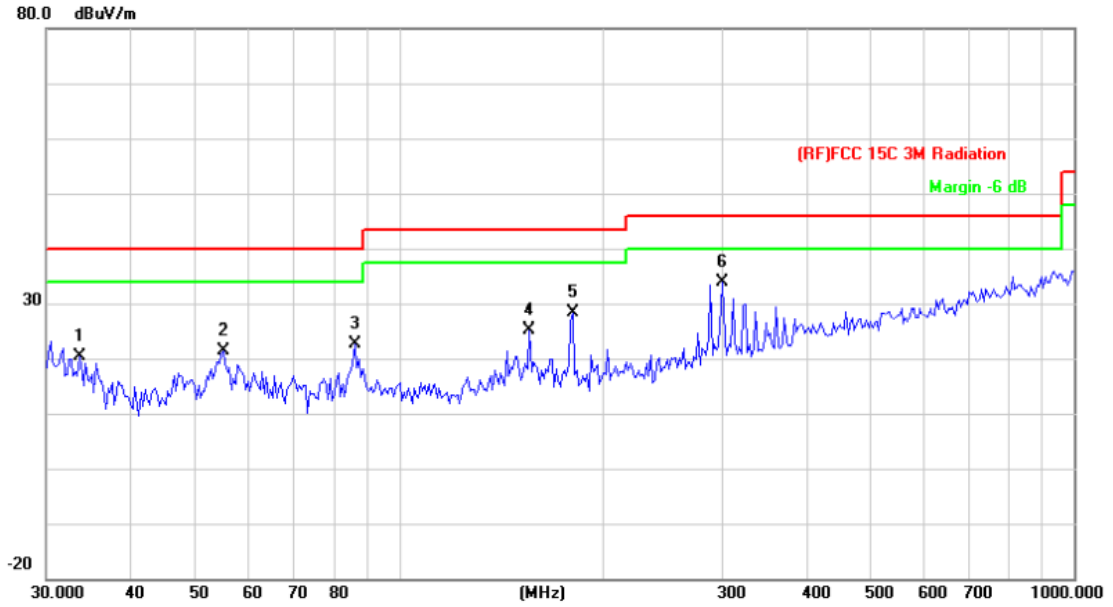

No.	Mk.	Freq. MHz	Reading Level dBuV	Correct Factor dB/m	Measure- ment dBuV/m	Limit dBuV/m	Over dB	Detector
1		33.5624	31.81	-11.35	20.46	40.00	-19.54	peak
2		54.8348	38.28	-16.84	21.44	40.00	-18.56	peak
3		85.8984	38.14	-15.48	22.66	40.00	-17.34	peak
4		155.9101	39.08	-14.01	25.07	43.50	-18.43	peak
5		180.6488	41.81	-13.46	28.35	43.50	-15.15	peak
6	*	301.4224	42.00	-8.10	33.90	46.00	-12.10	peak

\*:Maximum data    x:Over limit    !:over margin

**Remark:**

1. Corr. = Antenna Factor (dB/m) + Cable Loss (dB)
2. QuasiPeak (dBµV/m)= Corr. (dB/m)+ Read Level (dBµV)
3. Margin (dB) = QuasiPeak (dBµV/m)-Limit QPK(dBµV/m)

**Above 1GHz**

<b>Temperature:</b>	26°C	<b>Relative Humidity:</b>	54%
<b>Test Voltage:</b>	AC 120V/60HZ		
<b>Ant. Pol.</b>	Horizontal		
<b>Test Mode:</b>	TX GFSK Mode 2402MHz		

No.	Frequency (MHz)	Reading (dBuV)	Factor (dB/m)	Level (dBuV/m)	Limit (dBuV/m)	Margin (dB)	Detector
1	9109.000	47.91	-4.83	43.08	74.00	-30.92	peak
2 *	13342.000	42.92	6.05	48.97	74.00	-25.03	peak

**Remark:**

1. Corr. = Antenna Factor (dB/m) + Cable Loss (dB)
2. Peak/AVG (dBμV/m)= Corr. (dB/m)+ Read Level (dBμV)
3. Margin (dB) = Peak/AVG (dBμV/m)-Limit PK/AVG(dBμV/m)
4. The tests evaluated1-26.5GHz,The testing has been conformed to the 10th harmonic of the highest fundamental frequency.
5. No report for the emission which more than 20dB below the prescribed limit.
6. In the case of The peak value<average limit, So only show the peak value.

<b>Temperature:</b>	26°C	<b>Relative Humidity:</b>	54%
<b>Test Voltage:</b>	AC 120V/60HZ		
<b>Ant. Pol.</b>	Vertical		
<b>Test Mode:</b>	TX GFSK Mode 2402MHz		

No.	Frequency (MHz)	Reading (dBuV)	Factor (dB/m)	Level (dBuV/m)	Limit (dBuV/m)	Margin (dB)	Detector
1	7196.500	50.21	-8.93	41.28	74.00	-32.72	peak
2 *	10715.500	44.81	3.10	47.91	74.00	-26.09	peak

**Remark:**

1. Corr. = Antenna Factor (dB/m) + Cable Loss (dB)
2. Peak/AVG (dBμV/m)= Corr. (dB/m)+ Read Level (dBμV)
3. Margin (dB) = Peak/AVG (dBμV/m)-Limit PK/AVG(dBμV/m)
4. The tests evaluated1-26.5GHz,The testing has been conformed to the 10th harmonic of the highest fundamental frequency.
5. No report for the emission which more than 20dB below the prescribed limit.
6. In the case of The peak value<average limit, So only show the peak value.

<b>Temperature:</b>	26°C	<b>Relative Humidity:</b>	54%																								
<b>Test Voltage:</b>	AC 120V/60HZ																										
<b>Ant. Pol.</b>	Horizontal																										
<b>Test Mode:</b>	TX GFSK Mode 2441MHz																										
<table border="1"> <thead> <tr> <th>No.</th> <th>Frequency (MHz)</th> <th>Reading (dBuV)</th> <th>Factor (dB/m)</th> <th>Level (dBuV/m)</th> <th>Limit (dBuV/m)</th> <th>Margin (dB)</th> <th>Detector</th> </tr> </thead> <tbody> <tr> <td>1</td> <td>8216.500</td> <td>48.81</td> <td>-6.27</td> <td>42.54</td> <td>74.00</td> <td>-31.46</td> <td>peak</td> </tr> <tr> <td>2 *</td> <td>12118.000</td> <td>44.21</td> <td>5.36</td> <td>49.57</td> <td>74.00</td> <td>-24.43</td> <td>peak</td> </tr> </tbody> </table>				No.	Frequency (MHz)	Reading (dBuV)	Factor (dB/m)	Level (dBuV/m)	Limit (dBuV/m)	Margin (dB)	Detector	1	8216.500	48.81	-6.27	42.54	74.00	-31.46	peak	2 *	12118.000	44.21	5.36	49.57	74.00	-24.43	peak
No.	Frequency (MHz)	Reading (dBuV)	Factor (dB/m)	Level (dBuV/m)	Limit (dBuV/m)	Margin (dB)	Detector																				
1	8216.500	48.81	-6.27	42.54	74.00	-31.46	peak																				
2 *	12118.000	44.21	5.36	49.57	74.00	-24.43	peak																				
<p><b>Remark:</b></p> <ol style="list-style-type: none"> <li>1. Corr. = Antenna Factor (dB/m) + Cable Loss (dB)</li> <li>2. Peak/AVG (dBμV/m)= Corr. (dB/m)+ Read Level (dBμV)</li> <li>3. Margin (dB) = Peak/AVG (dBμV/m)-Limit PK/AVG(dBμV/m)</li> <li>4. The tests evaluated1-26.5GHz,The testing has been conformed to the 10th harmonic of the highest fundamental frequency.</li> <li>5. No report for the emission which more than 20dB below the prescribed limit.</li> <li>6. In the case of The peak value&lt;average limit, So only show the peak value.</li> </ol>																											

<b>Temperature:</b>	26°C	<b>Relative Humidity:</b>	54%																								
<b>Test Voltage:</b>	AC 120V/60HZ																										
<b>Ant. Pol.</b>	Vertical																										
<b>Test Mode:</b>	TX GFSK Mode 2441MHz																										
<table border="1"> <thead> <tr> <th>No.</th> <th>Frequency (MHz)</th> <th>Reading (dBuV)</th> <th>Factor (dB/m)</th> <th>Level (dBuV/m)</th> <th>Limit (dBuV/m)</th> <th>Margin (dB)</th> <th>Detector</th> </tr> </thead> <tbody> <tr> <td>1</td> <td>10919.500</td> <td>44.98</td> <td>4.21</td> <td>49.19</td> <td>74.00</td> <td>-24.81</td> <td>peak</td> </tr> <tr> <td>2 *</td> <td>13673.500</td> <td>44.58</td> <td>6.20</td> <td>50.78</td> <td>74.00</td> <td>-23.22</td> <td>peak</td> </tr> </tbody> </table>				No.	Frequency (MHz)	Reading (dBuV)	Factor (dB/m)	Level (dBuV/m)	Limit (dBuV/m)	Margin (dB)	Detector	1	10919.500	44.98	4.21	49.19	74.00	-24.81	peak	2 *	13673.500	44.58	6.20	50.78	74.00	-23.22	peak
No.	Frequency (MHz)	Reading (dBuV)	Factor (dB/m)	Level (dBuV/m)	Limit (dBuV/m)	Margin (dB)	Detector																				
1	10919.500	44.98	4.21	49.19	74.00	-24.81	peak																				
2 *	13673.500	44.58	6.20	50.78	74.00	-23.22	peak																				
<p><b>Remark:</b></p> <ol style="list-style-type: none"> <li>1. Corr. = Antenna Factor (dB/m) + Cable Loss (dB)</li> <li>2. Peak/AVG (dBμV/m)= Corr. (dB/m)+ Read Level (dBμV)</li> <li>3. Margin (dB) = Peak/AVG (dBμV/m)-Limit PK/AVG(dBμV/m)</li> <li>4. The tests evaluated1-26.5GHz,The testing has been conformed to the 10th harmonic of the highest fundamental frequency.</li> <li>5. No report for the emission which more than 20dB below the prescribed limit.</li> <li>6. In the case of The peak value&lt;average limit, So only show the peak value.</li> </ol>																											

<b>Temperature:</b>	26°C	<b>Relative Humidity:</b>	54%
<b>Test Voltage:</b>	AC 120V/60HZ		
<b>Ant. Pol.</b>	Horizontal		
<b>Test Mode:</b>	TX GFSK Mode 2480MHz		

No.	Frequency (MHz)	Reading (dBuV)	Factor (dB/m)	Level (dBuV/m)	Limit (dBuV/m)	Margin (dB)	Detector
1	8165.500	49.57	-6.52	43.05	74.00	-30.95	peak
2 *	11302.000	45.85	4.85	50.70	74.00	-23.30	peak

**Remark:**

1. Corr. = Antenna Factor (dB/m) + Cable Loss (dB)
2. Peak/AVG (dBμV/m)= Corr. (dB/m)+ Read Level (dBμV)
3. Margin (dB) = Peak/AVG (dBμV/m)-Limit PK/AVG(dBμV/m)
4. The tests evaluated1-26.5GHz,The testing has been conformed to the 10th harmonic of the highest fundamental frequency.
5. No report for the emission which more than 20dB below the prescribed limit.
6. In the case of The peak value<average limit, So only show the peak value.

<b>Temperature:</b>	26°C	<b>Relative Humidity:</b>	54%
<b>Test Voltage:</b>	AC 120V/60HZ		
<b>Ant. Pol.</b>	Vertical		
<b>Test Mode:</b>	TX GFSK Mode 2480MHz		

No.	Frequency (MHz)	Reading (dBuV)	Factor (dB/m)	Level (dBuV/m)	Limit (dBuV/m)	Margin (dB)	Detector
1	7783.000	49.70	-7.03	42.67	74.00	-31.33	peak
2 *	10894.000	45.90	4.19	50.09	74.00	-23.91	peak

**Remark:**

1. Corr. = Antenna Factor (dB/m) + Cable Loss (dB)
2. Peak/AVG (dBμV/m)= Corr. (dB/m)+ Read Level (dBμV)
3. Margin (dB) = Peak/AVG (dBμV/m)-Limit PK/AVG(dBμV/m)
4. The tests evaluated1-26.5GHz,The testing has been conformed to the 10th harmonic of the highest fundamental frequency.
5. No report for the emission which more than 20dB below the prescribed limit.
6. In the case of The peak value<average limit, So only show the peak value.

<b>Temperature:</b>	26°C	<b>Relative Humidity:</b>	54%
<b>Test Voltage:</b>	AC 120V/60HZ		
<b>Ant. Pol.</b>	Horizontal		
<b>Test Mode:</b>	TX $\pi$ /4-DQPSK Mode 2402MHz		

No.	Frequency (MHz)	Reading (dBuV)	Factor (dB/m)	Level (dBuV/m)	Limit (dBuV/m)	Margin (dB)	Detector
1	7706.500	50.13	-7.12	43.01	74.00	-30.99	peak
2 *	12169.000	44.37	5.22	49.59	74.00	-24.41	peak

**Remark:**

1. Corr. = Antenna Factor (dB/m) + Cable Loss (dB)
2. Peak/AVG (dB $\mu$ V/m)= Corr. (dB/m)+ Read Level (dB $\mu$ V)
3. Margin (dB) = Peak/AVG (dB $\mu$ V/m)-Limit PK/AVG(dB $\mu$ V/m)
4. The tests evaluated1-26.5GHz,The testing has been conformed to the 10th harmonic of the highest fundamental frequency.
5. No report for the emission which more than 20dB below the prescribed limit.
6. In the case of The peak value<average limit, So only show the peak value.

<b>Temperature:</b>	26°C	<b>Relative Humidity:</b>	54%
<b>Test Voltage:</b>	AC 120V/60HZ		
<b>Ant. Pol.</b>	Vertical		
<b>Test Mode:</b>	TX $\pi$ /4-DQPSK Mode 2402MHz		

No.	Frequency (MHz)	Reading (dBuV)	Factor (dB/m)	Level (dBuV/m)	Limit (dBuV/m)	Margin (dB)	Detector
1	8981.500	48.09	-5.09	43.00	74.00	-31.00	peak
2 *	13087.000	43.98	5.98	49.96	74.00	-24.04	peak

**Remark:**

1. Corr. = Antenna Factor (dB/m) + Cable Loss (dB)
2. Peak/AVG (dB $\mu$ V/m)= Corr. (dB/m)+ Read Level (dB $\mu$ V)
3. Margin (dB) = Peak/AVG (dB $\mu$ V/m)-Limit PK/AVG(dB $\mu$ V/m)
4. The tests evaluated1-26.5GHz,The testing has been conformed to the 10th harmonic of the highest fundamental frequency.
5. No report for the emission which more than 20dB below the prescribed limit.
6. In the case of The peak value<average limit, So only show the peak value.

<b>Temperature:</b>	26°C	<b>Relative Humidity:</b>	54%
<b>Test Voltage:</b>	AC 120V/60HZ		
<b>Ant. Pol.</b>	Horizontal		
<b>Test Mode:</b>	TX π /4-DQPSK Mode 2441MHz		

No.	Frequency (MHz)	Reading (dBuV)	Factor (dB/m)	Level (dBuV/m)	Limit (dBuV/m)	Margin (dB)	Detector
1	10919.500	44.38	4.21	48.59	74.00	-25.41	peak
2 *	13240.000	44.72	5.93	50.65	74.00	-23.35	peak

**Remark:**

1. Corr. = Antenna Factor (dB/m) + Cable Loss (dB)
2. Peak/AVG (dBμV/m)= Corr. (dB/m)+ Read Level (dBμV)
3. Margin (dB) = Peak/AVG (dBμV/m)-Limit PK/AVG(dBμV/m)
4. The tests evaluated1-26.5GHz,The testing has been conformed to the 10th harmonic of the highest fundamental frequency.
5. No report for the emission which more than 20dB below the prescribed limit.
6. In the case of The peak value<average limit, So only show the peak value.

<b>Temperature:</b>	26°C	<b>Relative Humidity:</b>	54%
<b>Test Voltage:</b>	AC 120V/60HZ		
<b>Ant. Pol.</b>	Vertical		
<b>Test Mode:</b>	TX π /4-DQPSK Mode 2441MHz		

No.	Frequency (MHz)	Reading (dBuV)	Factor (dB/m)	Level (dBuV/m)	Limit (dBuV/m)	Margin (dB)	Detector
1 *	12730.000	44.69	5.71	50.40	74.00	-23.60	peak
2	15025.000	42.89	7.34	50.23	74.00	-23.77	peak

**Remark:**

1. Corr. = Antenna Factor (dB/m) + Cable Loss (dB)
2. Peak/AVG (dBμV/m)= Corr. (dB/m)+ Read Level (dBμV)
3. Margin (dB) = Peak/AVG (dBμV/m)-Limit PK/AVG(dBμV/m)
4. The tests evaluated1-26.5GHz,The testing has been conformed to the 10th harmonic of the highest fundamental frequency.
5. No report for the emission which more than 20dB below the prescribed limit.
6. In the case of The peak value<average limit, So only show the peak value.

<b>Temperature:</b>	26°C	<b>Relative Humidity:</b>	54%
<b>Test Voltage:</b>	AC 120V/60HZ		
<b>Ant. Pol.</b>	Horizontal		
<b>Test Mode:</b>	TX $\pi$ /4-DQPSK Mode 2480MHz		

No.	Frequency (MHz)	Reading (dBuV)	Factor (dB/m)	Level (dBuV/m)	Limit (dBuV/m)	Margin (dB)	Detector
1	5029.000	51.56	-13.44	38.12	74.00	-35.88	peak
2 *	13291.000	43.78	5.90	49.68	74.00	-24.32	peak

**Remark:**

1. Corr. = Antenna Factor (dB/m) + Cable Loss (dB)
2. Peak/AVG (dB $\mu$ V/m)= Corr. (dB/m)+ Read Level (dB $\mu$ V)
3. Margin (dB) = Peak/AVG (dB $\mu$ V/m)-Limit PK/AVG(dB $\mu$ V/m)
4. The tests evaluated1-26.5GHz,The testing has been conformed to the 10th harmonic of the highest fundamental frequency.
5. No report for the emission which more than 20dB below the prescribed limit.
6. In the case of The peak value<average limit, So only show the peak value.

<b>Temperature:</b>	26°C	<b>Relative Humidity:</b>	54%
<b>Test Voltage:</b>	AC 120V/60HZ		
<b>Ant. Pol.</b>	Vertical		
<b>Test Mode:</b>	TX $\pi$ /4-DQPSK Mode 2480MHz		

No.	Frequency (MHz)	Reading (dBuV)	Factor (dB/m)	Level (dBuV/m)	Limit (dBuV/m)	Margin (dB)	Detector
1	10919.500	44.45	4.21	48.66	74.00	-25.34	peak
2 *	12118.000	44.78	5.36	50.14	74.00	-23.86	peak

**Remark:**

1. Corr. = Antenna Factor (dB/m) + Cable Loss (dB)
2. Peak/AVG (dB $\mu$ V/m)= Corr. (dB/m)+ Read Level (dB $\mu$ V)
3. Margin (dB) = Peak/AVG (dB $\mu$ V/m)-Limit PK/AVG(dB $\mu$ V/m)
4. The tests evaluated1-26.5GHz,The testing has been conformed to the 10th harmonic of the highest fundamental frequency.
5. No report for the emission which more than 20dB below the prescribed limit.
6. In the case of The peak value<average limit, So only show the peak value.



<b>Temperature:</b>	26°C	<b>Relative Humidity:</b>	54%																								
<b>Test Voltage:</b>	AC 120V/60HZ																										
<b>Ant. Pol.</b>	Horizontal																										
<b>Test Mode:</b>	TX 8-DPSK Mode 2402MHz																										
<table border="1"> <thead> <tr> <th>No.</th> <th>Frequency (MHz)</th> <th>Reading (dBuV)</th> <th>Factor (dB/m)</th> <th>Level (dBuV/m)</th> <th>Limit (dBuV/m)</th> <th>Margin (dB)</th> <th>Detector</th> </tr> </thead> <tbody> <tr> <td>1</td> <td>9313.000</td> <td>47.98</td> <td>-3.69</td> <td>44.29</td> <td>74.00</td> <td>-29.71</td> <td>peak</td> </tr> <tr> <td>2 *</td> <td>11302.000</td> <td>45.31</td> <td>4.85</td> <td>50.16</td> <td>74.00</td> <td>-23.84</td> <td>peak</td> </tr> </tbody> </table>				No.	Frequency (MHz)	Reading (dBuV)	Factor (dB/m)	Level (dBuV/m)	Limit (dBuV/m)	Margin (dB)	Detector	1	9313.000	47.98	-3.69	44.29	74.00	-29.71	peak	2 *	11302.000	45.31	4.85	50.16	74.00	-23.84	peak
No.	Frequency (MHz)	Reading (dBuV)	Factor (dB/m)	Level (dBuV/m)	Limit (dBuV/m)	Margin (dB)	Detector																				
1	9313.000	47.98	-3.69	44.29	74.00	-29.71	peak																				
2 *	11302.000	45.31	4.85	50.16	74.00	-23.84	peak																				
<p><b>Remark:</b></p> <ol style="list-style-type: none"> <li>1. Corr. = Antenna Factor (dB/m) + Cable Loss (dB)</li> <li>2. Peak/AVG (dBμV/m)= Corr. (dB/m)+ Read Level (dBμV)</li> <li>3. Margin (dB) = Peak/AVG (dBμV/m)-Limit PK/AVG(dBμV/m)</li> <li>4. The tests evaluated1-26.5GHz,The testing has been conformed to the 10th harmonic of the highest fundamental frequency.</li> <li>5. No report for the emission which more than 20dB below the prescribed limit.</li> <li>6. In the case of The peak value&lt;average limit, So only show the peak value.</li> </ol>																											

<b>Temperature:</b>	26°C	<b>Relative Humidity:</b>	54%																								
<b>Test Voltage:</b>	AC 120V/60HZ																										
<b>Ant. Pol.</b>	Vertical																										
<b>Test Mode:</b>	TX 8-DPSK Mode 2402MHz																										
<table border="1"> <thead> <tr> <th>No.</th> <th>Frequency (MHz)</th> <th>Reading (dBuV)</th> <th>Factor (dB/m)</th> <th>Level (dBuV/m)</th> <th>Limit (dBuV/m)</th> <th>Margin (dB)</th> <th>Detector</th> </tr> </thead> <tbody> <tr> <td>1</td> <td>9823.000</td> <td>46.42</td> <td>-0.76</td> <td>45.66</td> <td>74.00</td> <td>-28.34</td> <td>peak</td> </tr> <tr> <td>2 *</td> <td>13291.000</td> <td>44.06</td> <td>5.90</td> <td>49.96</td> <td>74.00</td> <td>-24.04</td> <td>peak</td> </tr> </tbody> </table>				No.	Frequency (MHz)	Reading (dBuV)	Factor (dB/m)	Level (dBuV/m)	Limit (dBuV/m)	Margin (dB)	Detector	1	9823.000	46.42	-0.76	45.66	74.00	-28.34	peak	2 *	13291.000	44.06	5.90	49.96	74.00	-24.04	peak
No.	Frequency (MHz)	Reading (dBuV)	Factor (dB/m)	Level (dBuV/m)	Limit (dBuV/m)	Margin (dB)	Detector																				
1	9823.000	46.42	-0.76	45.66	74.00	-28.34	peak																				
2 *	13291.000	44.06	5.90	49.96	74.00	-24.04	peak																				
<p><b>Remark:</b></p> <ol style="list-style-type: none"> <li>1. Corr. = Antenna Factor (dB/m) + Cable Loss (dB)</li> <li>2. Peak/AVG (dBμV/m)= Corr. (dB/m)+ Read Level (dBμV)</li> <li>3. Margin (dB) = Peak/AVG (dBμV/m)-Limit PK/AVG(dBμV/m)</li> <li>4. The tests evaluated1-26.5GHz,The testing has been conformed to the 10th harmonic of the highest fundamental frequency.</li> <li>5. No report for the emission which more than 20dB below the prescribed limit.</li> <li>6. In the case of The peak value&lt;average limit, So only show the peak value.</li> </ol>																											

<b>Temperature:</b>	26°C	<b>Relative Humidity:</b>	54%
<b>Test Voltage:</b>	AC 120V/60HZ		
<b>Ant. Pol.</b>	Horizontal		
<b>Test Mode:</b>	TX 8-DPSK Mode 2441MHz		

No.	Frequency (MHz)	Reading (dBuV)	Factor (dB/m)	Level (dBuV/m)	Limit (dBuV/m)	Margin (dB)	Detector
1	8114.500	49.35	-6.79	42.56	74.00	-31.44	peak
2 *	11327.500	44.50	4.89	49.39	74.00	-24.61	peak

**Remark:**

1. Corr. = Antenna Factor (dB/m) + Cable Loss (dB)
2. Peak/AVG (dBμV/m)= Corr. (dB/m)+ Read Level (dBμV)
3. Margin (dB) = Peak/AVG (dBμV/m)-Limit PK/AVG(dBμV/m)
4. The tests evaluated1-26.5GHz,The testing has been conformed to the 10th harmonic of the highest fundamental frequency.
5. No report for the emission which more than 20dB below the prescribed limit.
6. In the case of The peak value<average limit, So only show the peak value.

<b>Temperature:</b>	26°C	<b>Relative Humidity:</b>	54%
<b>Test Voltage:</b>	AC 120V/60HZ		
<b>Ant. Pol.</b>	Vertical		
<b>Test Mode:</b>	TX 8-DPSK Mode 2441MHz		

No.	Frequency (MHz)	Reading (dBuV)	Factor (dB/m)	Level (dBuV/m)	Limit (dBuV/m)	Margin (dB)	Detector
1 *	10511.500	47.65	2.39	50.04	74.00	-23.96	peak
2	12628.000	43.67	5.77	49.44	74.00	-24.56	peak

**Remark:**

1. Corr. = Antenna Factor (dB/m) + Cable Loss (dB)
2. Peak/AVG (dBμV/m)= Corr. (dB/m)+ Read Level (dBμV)
3. Margin (dB) = Peak/AVG (dBμV/m)-Limit PK/AVG(dBμV/m)
4. The tests evaluated1-26.5GHz,The testing has been conformed to the 10th harmonic of the highest fundamental frequency.
5. No report for the emission which more than 20dB below the prescribed limit.
6. In the case of The peak value<average limit, So only show the peak value.

<b>Temperature:</b>	26°C	<b>Relative Humidity:</b>	54%
<b>Test Voltage:</b>	AC 120V/60HZ		
<b>Ant. Pol.</b>	Horizontal		
<b>Test Mode:</b>	TX 8-DPSK Mode 2480MHZ		

No.	Frequency (MHz)	Reading (dBuV)	Factor (dB/m)	Level (dBuV/m)	Limit (dBuV/m)	Margin (dB)	Detector
1	10919.500	45.15	4.21	49.36	74.00	-24.64	peak
2 *	13393.000	43.98	6.24	50.22	74.00	-23.78	peak

**Remark:**

1. Corr. = Antenna Factor (dB/m) + Cable Loss (dB)
2. Peak/AVG (dBμV/m)= Corr. (dB/m)+ Read Level (dBμV)
3. Margin (dB) = Peak/AVG (dBμV/m)-Limit PK/AVG(dBμV/m)
4. The tests evaluated1-26.5GHz,The testing has been conformed to the 10th harmonic of the highest fundamental frequency.
5. No report for the emission which more than 20dB below the prescribed limit.
6. In the case of The peak value<average limit, So only show the peak value.

<b>Temperature:</b>	26°C	<b>Relative Humidity:</b>	54%
<b>Test Voltage:</b>	AC 120V/60HZ		
<b>Ant. Pol.</b>	Vertical		
<b>Test Mode:</b>	TX 8-DPSK Mode 2480MHZ		

No.	Frequency (MHz)	Reading (dBuV)	Factor (dB/m)	Level (dBuV/m)	Limit (dBuV/m)	Margin (dB)	Detector
1 *	10817.500	46.12	3.82	49.94	74.00	-24.06	peak
2	13571.500	43.92	6.01	49.93	74.00	-24.07	peak

**Remark:**

1. Corr. = Antenna Factor (dB/m) + Cable Loss (dB)
2. Peak/AVG (dBμV/m)= Corr. (dB/m)+ Read Level (dBμV)
3. Margin (dB) = Peak/AVG (dBμV/m)-Limit PK/AVG(dBμV/m)
4. The tests evaluated1-26.5GHz,The testing has been conformed to the 10th harmonic of the highest fundamental frequency.
5. No report for the emission which more than 20dB below the prescribed limit.
6. In the case of The peak value<average limit, So only show the peak value.

-----END OF REPORT-----