

WIRELESS FULL DUPLEX INTERCOM

Real-time Two-way Talk

Instruction Manual

Model: HY812

Contents

Overview	3
What's in the box	4
Operation & Features	7
1. MIC	8
2.  (End/Answer Button)	8
3. MONITORED	8
4. NOISY MODE	9
5. GROUP (Group-Call Function)	10
6. VOL+/VOL-(Volume Adjustment)	10
7. How to Assign a Channel to Your Intercom	10
Technical Specifications	11
Troubleshooting	13
Cautions	15
Limited 24 Months Warranty	17
FCC Statement	20
1. FCC RF Radiation Exposure Statement	23
2. The FCC Wants You to Know	23
ISED Statement	24
The Hosmart Story	26

Overview

HY-812 is a top-notch wireless full duplex real-time portable intercom system, proudly crafted by Hosmart. Renowned for its exceptional sound quality, the HY812 intercom stands out among all other intercoms in our lineup. The HY-812 intercom, equipped with a built-in antenna, covers an expansive range of 1200 feet in open areas. This intercom ensures crystal-clear two-way communication, enhanced reliability, and secure transmissions.

What's In The Box

2

1. Intercoms
2. USB Cable
3. Power Adapter
4. Documentation

1

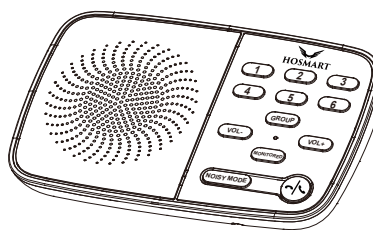

2

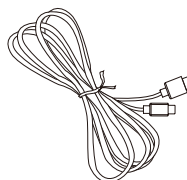

3

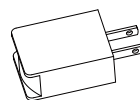

4

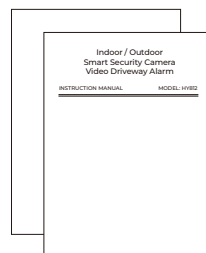

Operation & Features

3

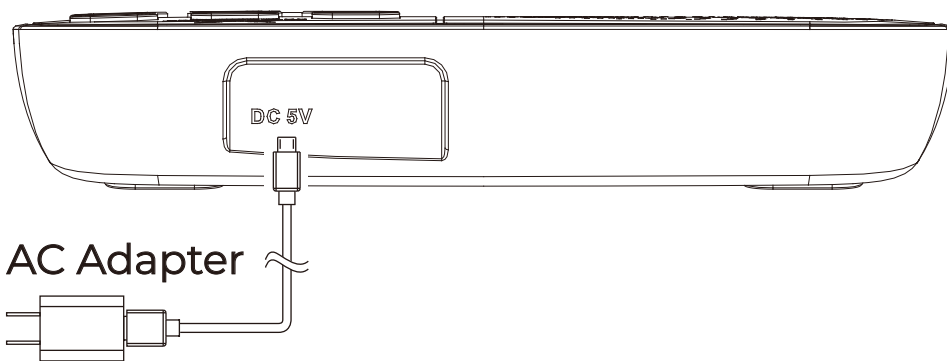
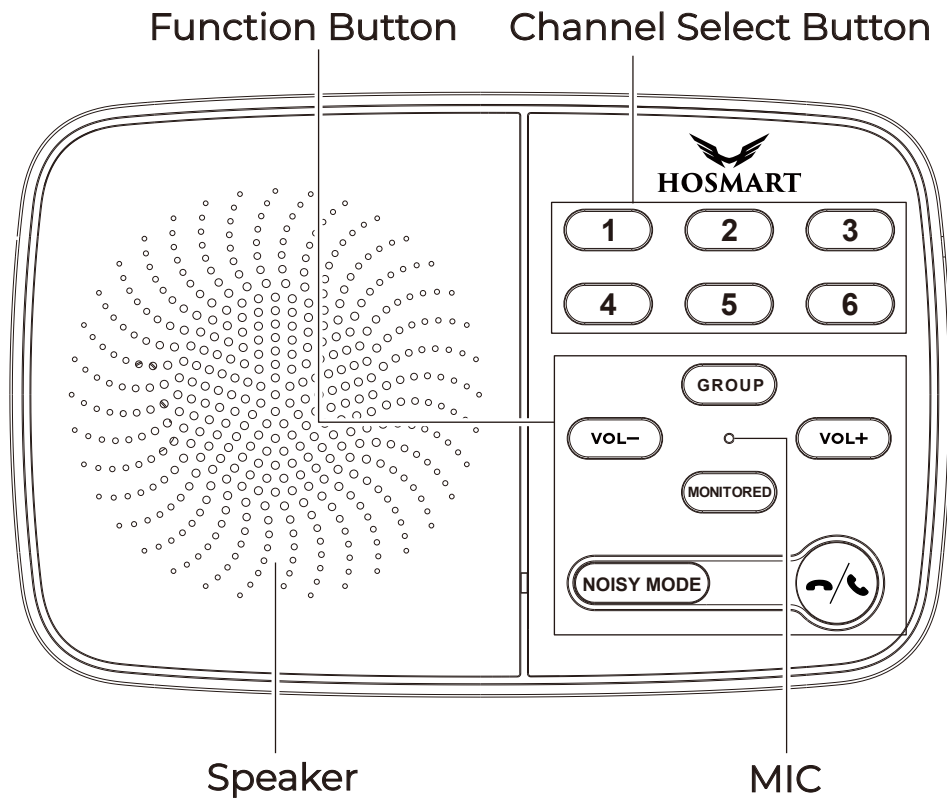

1. MIC

The best speaking distance is about 30cm away from the MIC hole.

2. (End/Answer Button)

How to Make a Call

To make a phone call, simply press the corresponding number channel button on the keypad. To end the call, just press the “  ” once.

3. MONITORED

Pressing “MONITORED” puts this intercom in a “monitored” mode.

Press “MONITEORED” then press one channel you want, then this intercom will be monitored by the intercom corresponding to the channel you choose, for 24 hours.

Press “  ” to exit monitor mode.

Note: *Monitored Function - For continuous talk or room monitoring which can last up to 24 hours.*

4. NOISY MODE

When you are in a noisy environment, please use the noisy mode (environmental noise between 65 to 75 decibels). If the environmental noise exceeds 80 decibels, it is not recommended to use this intercom for communication as the call quality cannot be guaranteed.

1) To activate the noisy mode on the intercom, press and hold the "NOISY MODE" button for 3 seconds. You will hear a beep sound, indicating that the intercom has entered the noisy mode.

Note: *This action only activates the noisy mode on the current device and can only be done when not in an ongoing call.*

When one of the intercoms enters the noisy mode, the rest of the intercoms should also be operated to enter the noisy mode. Please make sure that all the intercoms are used in the same mode.

2) To exit the noisy mode, simply unplug the power cord and then plug it back in to power on the intercom. Upon powering on, the intercom will revert back to the regular mode.

5. GROUP (Group-Call Function)

Press the “GROUP” button to call out that all intercoms already connected. All intercoms will ring at the same time.

Press the “” button on any of them to answer the call in.

Press the “” button to exit the group mode.

Note: *The Group button can call all intercoms in the system, but only talk to one unit. After one of the intercoms picks up the call, the rest cannot pick up the call.*

6. Volume Adjustment (VOL+/VOL-)

1) You can press “VOL+” or “VOL-” to adjust the volume.

2) To change the ringtone, you should press and hold the VOL+ for 3 second, then you can select a ringtone that you like, you have 8 melodies to choose from. You can press the “VOL+” and “VOL-” Buttons to select different ringtones.

7. How to Assign a Channel to Your Intercom

Typically, the channels are already preconfigured in the intercoms at the factory, allowing customers to use them directly upon receiving.

However, if you have purchased additional intercoms to expand your system, you can assign a new channel to your new intercom. Simply press and hold the desired number button on the intercom until you hear a beep sound, indicating that the channel assignment is successful.

Note: *It is not recommended to assign the same channel to multiple intercoms.*

Technical Specifications



Power Supply/InPut:

5V/1A

Wireless Transmission Distance:

1200 Feet (350 meters) in empty open area

Wireless Transmission Power:

≤1W

Work Temperature:

-4°F to 140°F (-20°C to +60°C)

Power Adapter:

100-240V

Troubleshooting

5



1) Intercom cannot power on.

a. Make sure the AC adapter and USB cable are connected properly.

2) Cannot talk to other intercoms.

a. Use the GROUP function to confirm whether the intercom cannot answer and make calls.

b. Check the receiving distance between the intercoms if it is out of range.

3) The sound of the intercom is too low.

a. Make sure the volume of the intercom has been increased enough.

b. Try to be closer to the MIC during the talk.

4) Intercom is not getting the expected transmission range.

a. Keep the intercom away from metal objects and interference sources. Some electrical equipment will also interfere with the intercom to cause the static, e.g. Microwave Oven, router, cell phone, or other radio devices, please try to adjust the position of the intercom.

5) Static noise and howling noise can be heard from the intercom.

a. Maybe the two intercoms are too close, please try to move away.

b. If the problem has not been solved, please contact us for technical support through the after-sale email.

Cautions



The following will help you maintain your wireless intercom for years to come.

- * Keep stations from getting wet. It is not waterproof.
- * Keep stations in a controlled environment. No extreme temperatures.
- * Handle the stations with care. No dropping, throwing, or roughness.
- * Keep stations clean from dust and dirt for this can damage the circuit board.
- * Do not use chemicals or cleaning solvents. Simply use a damp cloth to clean the station.
- * Modifying or tampering with the station's internal components can cause it to malfunction as well as null your warranty.
- * If your product is not working as advertised, please contact us by email for assistance.

**Limited 24 Months
Warranty**





EXCEPT AS PROVIDED HEREIN, SELLER MAKES NO EXPRESS WARRANTIES AND ANY IMPLIED WARRANTIES, INCLUDING THOSE OF MERCHANTABILITY AND FITNESS FOR A PARTICULAR PURPOSE, ARE LIMITED IN DURATION TO THE DURATION OF THE WRITTEN LIMITED WARRANTIES CONTAINED HEREIN, EXCEPT AS PROVIDED HEREIN, SELLER SHALL HAVE NO LIABILITY OR RESPONSIBILITY TO CUSTOMER OR ANY OTHER PERSON OR ENTITY WITH RESPECT TO ANY LIABILITY, LOSS OR DAMAGE CAUSED DIRECTLY OR INDIRECTLY BY USE OR PERFORMANCE OF THE PRODUCT OR ARISING OUT OF ANY BREACH OF THIS WARRANTY, INCLUDING, BUT NOT LIMITED TO ANY DAMAGES RESULTING FROM INCONVENIENCE, LOSS OF TIME, DATA, PROPERTY, REVENUE, OR PROFIT OR ANY INDIRECT, SPECIAL, INCIDENTAL, OR CONSEQUENTIAL DAMAGES, EVEN IF SELLER HAS BEEN ADVISED OF THE POSSIBILITY OF SUCH DAMAGES.

In the event of a product defect during the warranty period, contact the Seller to obtain an RBM#, and then return the product, along with the sales receipt as proof of purchase date, to Seller. The Seller will, at its option either correct the defect by product repair without charge for parts and labor; replace the product with one of the same or similar design or refund the purchase price.

All replaced parts and products and refunded products become the property of the Seller. New or reconditioned parts and products may be used in the performance of warranty service. Repaired or replaced parts and products are warranted for the remainder of the original warranty period. You will be charged for repairs on products no longer covered by warranty.

For all returns, please write down the RBM# and return date on the outside of the package. This will speed up the process of handling your return and issuing a refund or providing you with a replacement. Refunds are not issued for products no longer covered by warranty. The warranty will not cover replacements in cases where damage or failure is caused by, or attributable to:

- (a)** acts of God, abuse, accident, misuse, improper abnormal usage, failure to follow instructions, improper installation or maintenance, alteration, lightning or other instance of excess voltage or current,
- (b)** any repairs other than those provided by the Seller,
- (c)** consumables such as fuses or batteries,
- (d)** cosmetic damage,
- (e)** transportation, shipping or insurance costs,
- (f)** or costs of product removal, installation, set-up, service adjustment or reinstallation.

Our goal is for you to have the best possible experience with Hosmart. We appreciate receiving comments on any aspect of your experience with Hosmart or our products. Please contact us with any problems, prior to leaving any online feedback, so that we may address your concern. We guarantee you complete satisfaction for this transaction. Please note that our office hours are 9:00 am to 5:00 pm (GMT+8) Monday through Friday. Offices are closed Saturday, Sunday and public holidays. We apologize for any late replies during holidays.

FCC Statement



FCC ID:
2AXOF-HY812

Power:
DC 5V 1000 mA

Input:
100-240V

Output:
5V

This equipment generates uses and can radiate radio frequency energy and,if not installed and used in accordance with the instructions,may cause harmful interference to radio communications.However,there is no guarantee that interference will not occur in a particular installation.if this equipmemt does cause harmful interference to radio or television reception,which can be determined by turning the equipment off and on,the user is encouraged to try to correct the interference by one or more of the following measures:

-
- **Reorient or relocate the receiving antenna.**
 - **Increase the separation between the equipment and receiver.**
 - **Connect the equipment into an outlet on a circuit different from that to which the receiver is connected.**
 - **Consult the dealer or an experienced radio / TV technician for help.**
-

The device has been evaluated to meet general RF exposure requirement,This equipment should be installed and operated with a minumum distance of 20 cm between the radiator and your body.



This device complies with Part 15 of the FCC Rules. Operation is subject to the following two conditions:

- (1) This device may not cause harmful interference.
- (2) This device must accept any interference received, including interference that may cause undesired operation.

Changes or modifications not expressly approved by the party responsible for compliance could void the user's authority to operate the equipment.

Note: This equipment has been tested and found to comply with the limits for a class B digital device, pursuant to Part 15 of the FCC Rules. These limits are designed to provide reasonable protection against harmful interference in a residential installation.

1. FCC RF Radiation Exposure Statement

1. This Transmitter must not be co-located or operating in conjunction with any other antenna or transmitter.
2. This equipment complies with RF radiation exposure limits set forth for an uncontrolled environment.
3. This equipment should be installed and operated with minimum distance 20cm between the radiator & your body.

2. THE FCC WANTS YOU TO KNOW

Your intercom may cause TV or radio interference. To be a certain turn off your intercom and check your TV or radio on its performance. If still receiving interference, rest a sure it is not your intercom. You may try to eliminate interference by:

****Moving your stations further away from the receiver.***

****Moving your stations further away from your TV or radio.***

If these options do not solve your problem the FCC requires you to stop using your intercom. Change or modifications not approved by the party responsible for compliance could void the user authority to operate the equipment.

ISED Statement



This device contains licence-exempt transmitter(s)/receiver(s) that comply with Innovation, Science and Economic Development Canada's licence-exempt RSS(s). Operation is subject to the following two conditions:

- 1. This device may not cause interference.***
- 2. This device must accept any interference, including interference that may cause undesired operation of the device.***
- 3. This equipment should be installed and operated with a minimum distance of 20 cm between the radiator and your bod.***

Le présent appareil est conforme aux CNR d'Industrie Canada applicables aux appareils radio exempts de licence. L'exploitation est autorisée aux deux conditions suivantes:

- 1. L'appareil ne doit pas produire de brouillage, et.***
- 2. L'utilisateur de l'appareil doit accepter tout brouillage radioélectrique subi, même si le brouillage est susceptible d'en compromettre le fonctionnement.***
- 3. Cet équipement doit être installé et utilisé avec une distance minimale de 20 cm entre le radiateur et votre corps.***

This product manufactured by:

Macross Microelectronics (HK) Limited
FLAT/RM KY001 UNIT 3 27/F HO KING COMM CENTRE
NO.2-16FA YEEN STREET MONGKOK KL

The Hosmart Story

10

After tragically losing our grandmother in a home accident, I was inspired to create Hosmart tools specifically designed for the mature and elderly. In honor of our grandmother, our goal is to make homes smarter, safer, and more comfortable for seniors. We genuinely hope that Hosmart products bring convenience and peace of mind to both you and your loved ones in their golden years. We eagerly anticipate hearing your stories of how our Hosmart products have improved the lives of you or your senior family members, making them easier and safer.

William King
Inventor

If you have any questions, please contact us at:

service@hosmartmall.com

WWW.MYHOSMART.COM

**WELCOME
HOME**

**“ HO—
SMART**