

FCC Part 15E Test Report

FCC ID: 2AXO4-MXC1-1200M

Product Name:	Repeater
Trademark:	BETA.IOT
Model Name :	MX-C1-1200M
Prepared For :	Shenzhen Mengxin Chuangfu Industrial Co., Ltd.
Address :	No. 257, Shangwu Avenue, Shangwu Community, Shiyan Street, Baoan District, Shenzhen, China 518000
Prepared By :	Shenzhen BCTC Testing Co., Ltd.
Address :	BCTC Building & 1-2F, East of B Building, Pengzhou Industrial, Fuyuan 1st Road, Qiaotou Community, Fuyong Street, Bao'an District, Shenzhen, China
Test Date:	Aug. 14, 2020 – Aug. 31, 2020
Date of Report :	Aug. 31, 2020
Report No.:	BCTC2008001232-1E

TEST RESULT CERTIFICATION

Applicant's name : Shenzhen Mengxin Chuangfu Industrial Co., Ltd.
Address : No. 257, Shangwu Avenue, Shangwu Community, Shiyan Street,
Baoan District, Shenzhen, China 518000

Manufacturer's Name : Shenzhen Mengxin Chuangfu Industrial Co., Ltd.
Address : No. 257, Shangwu Avenue, Shangwu Community, Shiyan Street,
Baoan District, Shenzhen, China 518000

Product description

Product name : Repeater
Trademark : BETA.IOT

Model and/or type reference : MX-C1-1200M

Standards : FCC Part15 15.407
ANSI C63.10-2013
KDB 662911 D01 v02r01
KDB 789033 D02 v02r01

This device described above has been tested by BCTC, and the test results show that the equipment under test (EUT) is in compliance with the FCC requirements. And it is applicable only to the tested sample identified in the report.

This report shall not be reproduced except in full, without the written approval of BCTC, this document may be altered or revised by BCTC, personal only, and shall be noted in the revision of the document.

Prepared by(Engineer): Willem Wang



Reviewer(Supervisor): Eric Yang



Approved(Manager): Zero Zhou

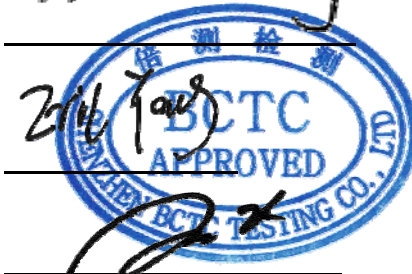

Table of Contents

	Page
1 . SUMMARY OF TEST RESULTS	6
1.1 TEST FACILITY	7
1.2 MEASUREMENT UNCERTAINTY	7
2 . GENERAL INFORMATION	8
2.1 GENERAL DESCRIPTION OF EUT	8
2.2 DESCRIPTION OF TEST MODES	10
2.3 BLOCK DIGRAM SHOWING THE CONFIGURATION OF SYSTEM TESTED	11
2.4 DESCRIPTION OF SUPPORT UNITS(CONDUCTED MODE)	11
2.5 EQUIPMENTS LIST FOR ALL TEST ITEMS	12
3 . EMC EMISSION TEST	14
3.1 CONDUCTED EMISSION MEASUREMENT	14
3.1.1 POWER LINE CONDUCTED EMISSION LIMITS	14
3.1.2 TEST PROCEDURE	15
3.1.3 DEVIATION FROM TEST STANDARD	15
3.1.4 TEST SETUP	15
3.1.5 EUT OPERATING CONDITIONS	15
3.2 RADIATED EMISSION MEASUREMENT	18
3.2.1 APPLICABLE STANDARD	18
3.2.2 CONFORMANCE LIMIT	18
3.2.3 MEASURING INSTRUMENTS	18
3.2.4 TEST CONFIGURATION	19
3.2.5 TEST PROCEDURE	20
3.2.6 TEST RESULTS (9KHZ – 30 MHZ)	21
3.2.7 TEST RESULTS (30MHZ – 1GHZ)	22
3.2.8 TEST RESULTS (1GHZ-40GHZ)	24
4 . POWER SPECTRAL DENSITY TEST	30
4.1 APPLIED PROCEDURES / LIMIT	30
4.2 TEST PROCEDURE	31
4.3 DEVIATION FROM STANDARD	31
4.4 TEST SETUP	31
4.5 EUT OPERATION CONDITIONS	31
4.6 TEST RESULTS	32
5 . 26DB&99% EMISSION BANDWIDTH	36
5.1 APPLIED PROCEDURES / LIMIT	36
5.2 TEST PROCEDURE	36

Table of Contents

	Page
5.3 EUT OPERATION CONDITIONS	37
5.4 TEST RESULTS	38
6 . MAXIMUM CONDUCTED OUTPUT POWER	43
6.1 PPLIED PROCEDURES / LIMIT	43
6.2 TEST PROCEDURE	43
6.3 DEVIATION FROM STANDARD	45
6.4 TEST SETUP	45
6.5 EUT OPERATION CONDITIONS	45
6.6 TEST RESULTS	46
7 . OUT OF BAND EMISSIONS	47
7.1 APPLICABLE STANDARD	47
7.2 TEST PROCEDURE	47
7.3 DEVIATION FROM STANDARD	47
7.4 TEST SETUP	47
7.5 EUT OPERATION CONDITIONS	48
7.6 TEST RESULTS	49
8.SPURIOUS RF CONDUCTED EMISSIONS	59
8.1CONFORMANCE LIMIT	59
8.2MEASURING INSTRUMENTS	59
8.3TEST SETUP	59
8.4TEST PROCEDURE	59
8.5TEST RESULTS	59
9. FREQUENCY STABILITY MEASUREMENT	67
9.1 LIMIT	67
9.2 TEST PROCEDURES	67
9.3 TEST SETUP LAYOUT	67
9.4 EUT OPERATION DURING TEST	67
9.5 TEST RESULTS	68
10. ANTENNA REQUIREMENT	71
10.1 STANDARD REQUIREMENT	71
10.2 EUT ANTENNA	71
11. EUT TEST PHOTO	72
12. EUT PHOTO	75

Revision History

Report No.	Version	Description	Issued Date
BCTC2008001232-1E	Rev.01	Initial issue of report	Aug. 31, 2020

1. SUMMARY OF TEST RESULTS

Test procedures according to the technical standards:

FCC Part15 (15.407) , Subpart E			
Standard Section	Test Item	Judgment	Remark
15.209(a), 15.407 (b)(1) 15.407 (b)(4) 15.407 (b)(6)	Spurious Radiated Emissions	PASS	
15.207	Conducted Emission	PASS	
15.407 (a)(5) 15.1049	26 dB and 99% Emission Bandwidth	PASS	
15.407 (a)(1) 15.407 (a)(3)	Maximum Conducted Output Power	PASS	
2.1051, 15.407(b)(1) 15.407(b)(4)	Band Edge	PASS	
15.407 (a)(1) 15.407 (a)(3)	Power Spectral Density	PASS	
2.1051, 15.407(b)	Spurious Emissions at Antenna Terminals	PASS	
15.203	Antenna Requirement	PASS	

NOTE:

(1) "N/A" denotes test is not applicable in this Test Report

1.1 TEST FACILITY

Shenzhen BCTC Testing Co., Ltd.

Add. : BCTC Building & 1-2F, East of B Building, Pengzhou Industrial, Fuyuan 1st Road, Qiaotou Community, Fuyong Street, Bao'an District, Shenzhen, China

FCC Test Firm Registration Number: 712850

IC Registered No.: 23583

1.2 MEASUREMENT UNCERTAINTY

The reported uncertainty of measurement $y \pm U$, where expanded uncertainty U is based on a standard uncertainty multiplied by a coverage factor of $k=2$, providing a level of confidence of approximately **95 %**.

No.	Item	Uncertainty
1	3m chamber Radiated spurious emission(30MHz-1GHz)	U=4.3dB
2	3m chamber Radiated spurious emission(1GHz-18GHz)	U=4.5dB
3	3m chamber Radiated spurious emission(18GHz-40GHz)	U=3.34dB
4	Conducted Adjacent channel power	U=1.38dB
5	Conducted output power uncertainty Above 1G	U=1.576dB
6	Conducted output power uncertainty below 1G	U=1.28dB
7	humidity uncertainty	U=5.3%
8	Temperature uncertainty	U=0.59°C

2. GENERAL INFORMATION

2.1 GENERAL DESCRIPTION OF EUT

Equipment	Repeater	
Trade Name	BETA.IOT	
Model Name	MX-C1-1200M	
Model Difference	N/A	
Product Description	IEEE 802.11 WLAN Mode Supported	<input checked="" type="checkbox"/> 802.11a/n/ac(20MHz channel bandwidth) <input checked="" type="checkbox"/> 802.11n/ac(40MHz channel bandwidth) <input checked="" type="checkbox"/> 802.11ac(80MHz channel bandwidth)
	Data Rate	802.11a: 6,9,12,18,24,36,48,54Mbps; 802.11n(HT20/HT40):MCS0-MCS15; 802.11ac(VHT20): NSS1, MCS0-MCS8 802.11ac(VHT40/VHT80):NSS1, MCS0-MCS9
	Modulation	OFDM with BPSK/QPSK/16QAM/64QAM/256QAM for 802.11a/n/ac;
	Operating Frequency Range	<input checked="" type="checkbox"/> 5180-5240MHz for 802.11a/n(HT20)/ac20; 5190-5230MHz for 802.11n(HT40)/ac40; 5210MHz for 802.11 ac80; <input type="checkbox"/> 5745-5825 MHz for 802.11a/n(HT20)/ac20; 5755-5795 MHz for 802.11a/n(HT40)/ac40; 5775MHz for 802.11 ac80;
	Number of Channels	<input checked="" type="checkbox"/> 4 channels for 802.11a/n20/ac20 in the 5180-5240MHz band ; 2 channels for 802.11 n40/ac40 in the 5190-5230MHz band ; 1 channels for 802.11 ac80 in the 5210MHz band ;
	Antenna Type	External antenna
	Antenna Gain	Antenna A:2dBi, Antenna B: 2dBi
	Based on the application, features, or specification exhibited in User's Manual, the EUT is considered as an ITE/Computing Device. More details of EUT technical specification, please refer to the User's Manual.	
Channel List	Please refer to the Note 2.	
Type of device	Indoor AP	
Power Supply	AC 100-240V 50/60 Hz	
hardware version	H1.0	
Software version	S1.0	
Connecting I/O Port(s)	Please refer to the User's Manual	

Note:

- For a more detailed features description, please refer to the manufacturer's specifications or the User's Manual.

2 Frequency and Channel list for 802.11a/n/ac(20MHz) band I (5180-5240MHz):

802.11a/n/ac(20MHz) Carrier Frequency Channel							
Channel	Frequency (MHz)	Channel	Frequency (MHz)	Channel	Frequency (MHz)	Channel	Frequency (MHz)
36	5180	44	5220	-	-	-	-
40	5200	48	5240	-	-	-	-

802.11n /ac(40MHz) Carrier Frequency Channel							
Channel	Frequency (MHz)	Channel	Frequency (MHz)	Channel	Frequency (MHz)	Channel	Frequency (MHz)
38	5190	-	-	-	-	-	-
46	5230	-	-	-	-	-	-

802.11ac (80MHz) Carrier Frequency Channel	
Channel	Frequency (MHz)
42	5210

EUT has two External antennas with Max gain GANT 2dBi on every antenna, CDD device with two spatial streams, also can operat with one spatial streams according to KDB662911 D01 v02r01,

Directional gain= GANT + Array Gain, where Array Gain is as follows.

- For power spectral density(PSD) measurements,
 $Array\ Gain = 10\log(NANT/NSS)dB = 10\log(2/1) = 3.01dB$,

So the directional gain for PSD is 5.01dBi

- For power measurements,
 The Array gain=0 dB for $NANT \leq 4$,

So the directional gain for Power measurements is 2dBi

Tx Antenna

Ant.	Brand	Model Name	Antenna Type	Gain (dBi)	NOTE
A	N/A	N/A	External antenna	2	
B	N/A	N/A	External antenna	2	

2.2 DESCRIPTION OF TEST MODES

Pretest Mode	Description
Mode 1	802.11a / n/ ac 20 CH36/ CH40/ CH 48
Mode 2	802.11n/ ac40 CH38/ CH 46
Mode 3	802.11 ac80 CH 42
Mode 4	802.11a / n/ ac 20 CH36/ CH40/ CH 48
Mode 5	Link Mode

Conducted Emission	
Final Test Mode	Description
Mode 5	Link Mode

For Radiated Emission	
Final Test Mode	Description
Mode 1	802.11a / n/ ac 20 CH36/ CH40/ CH 48
Mode 2	802.11n/ ac40 CH38/ CH 46
Mode 3	802.11 ac80 CH 42/CH 155
Mode 4	802.11a / n/ ac 20 CH36/ CH40/ CH 48

Note:

- (1) The measurements are performed at all Bit Rate of Transmitter, the worst data was reported.

2.3 BLOCK DIGRAM SHOWING THE CONFIGURATION OF SYSTEM TESTED

Conducted Emission Test

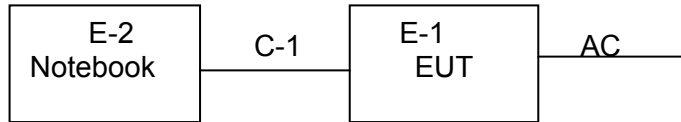

Radiated Spurious Emission

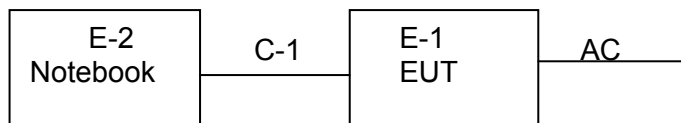

2.4 DESCRIPTION OF SUPPORT UNITS(CONDUCTED MODE)

The EUT has been tested as an independent unit together with other necessary accessories or support units. The following support units or accessories were used to form a representative test configuration during the tests.

Item	Equipment	Mfr/Brand	Model/Type No.	Series No.	Note
E-1	Repeater	BETA.IOT	MX-C1-1200M	N/A	EUT
E-2	Notebook	N/A	NOTE001	N/A	Auxiliary

Item	Shielded Type	Ferrite Core	Length	Note
C-1	NO	NO	0.5	Ethernet cable

Note:

- (1) The support equipment was authorized by Declaration of Confirmation.
- (2) For detachable type I/O cable should be specified the length in cm in 『Length』 column.

2.5 EQUIPMENTS LIST FOR ALL TEST ITEMS

Radiation Test equipment

Item	Equipment	Manufacturer	Type No.	Serial No.	Last calibration	Calibrated until
1	Spectrum Analyzer (9kHz-26.5GHz)	Agilent	E4407B	MY45109572	Jun. 08, 2020	Jun. 07, 2021
2	Test Receiver (9kHz-7GHz)	R&S	ESR7	101154	Jun. 08, 2020	Jun. 07, 2021
3	Bilog Antenna (30MHz-3GHz)	SCHWARZBECK	VULB9163	VULB9163-942	Jun. 08, 2020	Jun. 07, 2021
4	Horn Antenna (1GHz-18GHz)	SCHWARZBECK	BBHA9120D	1541	Jun. 10, 2020	Jun. 09, 2021
5	Horn Antenna (18GHz-40GHz)	SCHWARZBECK	BBHA9170	00822	Jun. 10, 2020	Jun. 09, 2021
6	Amplifier (9kHz-6GHz)	SCHWARZBECK	BBV9744	9744-0037	Jun. 04, 2020	Jun. 03, 2021
7	Amplifier (0.5GHz-18GHz)	SCHWARZBECK	BBV9718	9718-309	Jun. 04, 2020	Jun. 03, 2021
8	Amplifier (18GHz-40GHz)	MITEQ	TTA1840-35-HG	2034381	Jun. 08, 2020	Jun. 07, 2021
9	Loop Antenna (9kHz-30MHz)	SCHWARZBECK	FMZB1519B	00014	Jun. 08, 2020	Jun. 07, 2021
10	RF cables1 (9kHz-30MHz)	Huber+Suhnar	9kHz-30MHz	B1702988-0008	Jun. 08, 2020	Jun. 07, 2021
11	RF cables2 (30MHz-1GHz)	Huber+Suhnar	30MHz-1GHz	1486150	Jun. 08, 2020	Jun. 07, 2021
12	RF cables3 (1GHz-40GHz)	Huber+Suhnar	1GHz-40GHz	1607106	Jun. 08, 2020	Jun. 07, 2021
13	Power Metter	Keysight	E4419B	\	Jun. 08, 2020	Jun. 07, 2021
14	Power Sensor (AV)	Keysight	E9 300A	\	Jun. 08, 2020	Jun. 07, 2021
15	Signal Analyzer 20kHz-26.5GHz	KEYSIGHT	N9020A	MY49100060	Jun. 04, 2020	Jun. 03, 2021
16	Spectrum Analyzer 9kHz-40GHz	Agilent	FSP40	100363	Jun. 13, 2020	Jun. 12, 2021
17	D.C. Power Supply	LongWei	TPR-6405D	\	\	\
18	Software	Frad	EZ-EMC	FA-03A2 RE	\	\

Conduction Test equipment

Item	Equipment	Manufacturer	Type No.	Serial No.	Last calibration	Calibrated until
1	Test Receiver	R&S	ESR3	102075	Jun. 08, 2020	Jun. 07, 2021
2	LISN	SCHWARZBECK	NSLK8127	8127739	Jun. 13, 2020	Jun. 12, 2021
3	LISN	R&S	ENV216	101375	Jun. 04, 2020	Jun. 03, 2021
4	RF cables	Huber+Suhnar	9kHz-30MHz	B1702988-0008	Jun. 08, 2020	Jun. 07, 2021
5	Software	Frad	EZ-EMC	EMC-CON 3A1	\	\

3. EMC EMISSION TEST

3.1 CONDUCTED EMISSION MEASUREMENT

3.1.1 POWER LINE CONDUCTED EMISSION Limits (Frequency Range 150KHz-30MHz)

FREQUENCY (MHz)	Class B (dBuV)		Standard
	Quasi-peak	Average	
0.15 -0.5	66 - 56 *	56 - 46 *	CISPR
0.50 -5.0	56.00	46.00	CISPR
5.0 -30.0	60.00	50.00	CISPR

0.15 -0.5	66 - 56 *	56 - 46 *	FCC/ RSS-247
0.50 -5.0	56.00	46.00	FCC/ RSS-247
5.0 -30.0	60.00	50.00	FCC/ RSS-247

Note:

- (1) The tighter limit applies at the band edges.
- (2) The limit of " * " marked band means the limitation decreases linearly with the logarithm of the frequency in the range.

The following table is the setting of the receiver

Receiver Parameters	Setting
Attenuation	10 dB
Start Frequency	0.15 MHz
Stop Frequency	30 MHz
IF Bandwidth	9 kHz

3.1.2 TEST PROCEDURE

- The EUT was placed 0.8 meters from the horizontal ground plane with EUT being connected to the power mains through a line impedance stabilization network (LISN). All other support equipments powered from additional LISN(s). The LISN provide 50 Ohm/ 50uH of coupling impedance for the measuring instrument.
- Interconnecting cables that hang closer than 40 cm to the ground plane shall be folded back and forth in the center forming a bundle 30 to 40 cm long.
- I/O cables that are not connected to a peripheral shall be bundled in the center. The end of the cable may be terminated, if required, using the correct terminating impedance. The overall length shall not exceed 1 m.
- LISN at least 80 cm from nearest part of EUT chassis.
- For the actual test configuration, please refer to the related Item –EUT Test Photos.

3.1.3 DEVIATION FROM TEST STANDARD

No deviation

3.1.4 TEST SETUP

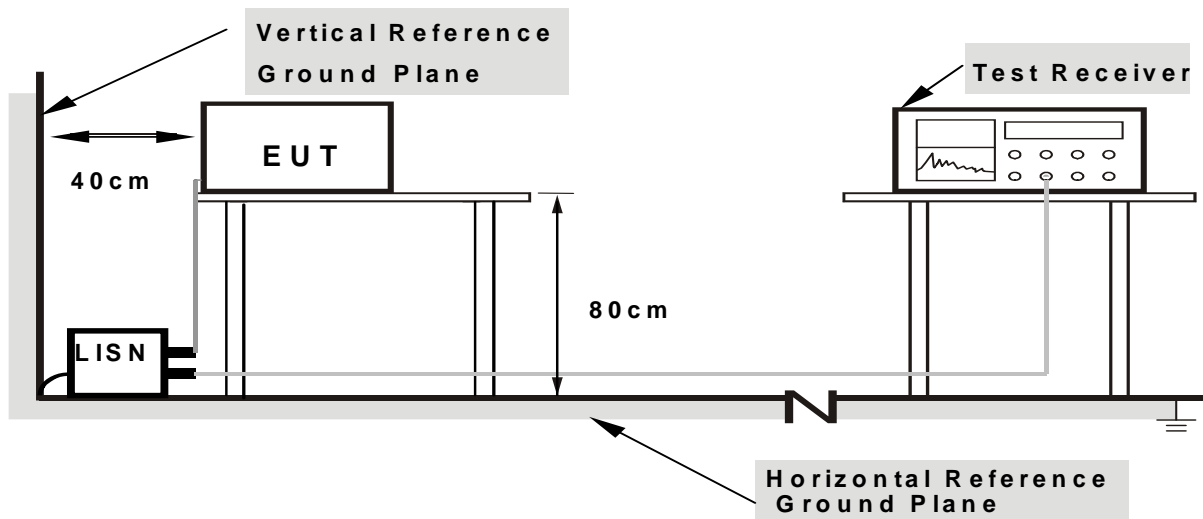

Note: 1.Support units were connected to second LISN.

2.Both of LISNs (AMN) are 80 cm from EUT and at least 80 from other units and other metal planes

3.1.5 EUT OPERATING CONDITIONS

The EUT was configured for testing in a typical fashion (as a customer would normally use it). The EUT has been programmed to continuously transmit during test. This operating condition was tested and used to collect the included data.

We pretest AC 120V and AC 240V, the worst voltage was AC 120V and the data recording in the report.

Temperature :	26 °C	Relative Humidity :	54%
Pressure :	101kPa	Phase :	L
Test Voltage :	AC 120V/60Hz	Test Mode :	Mode 5

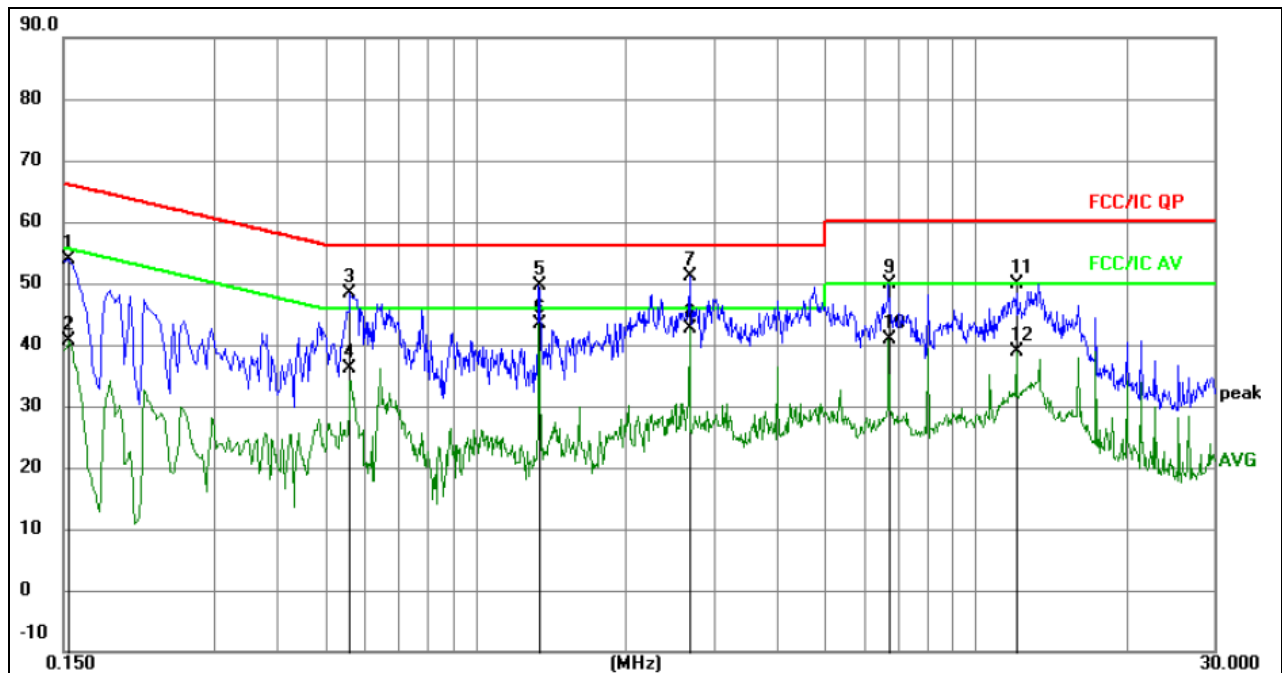
Remark:

1. All readings are Quasi-Peak and Average values.
2. Factor = Insertion Loss + Cable Loss.

No.	Mk.	Freq. MHz	Reading Level dB	Correct Factor dB	Measurement dBuV	Limit dBuV	Over dB	Detector	Comment
1		0.1539	44.31	9.52	53.83	65.79	-11.96	QP	
2		0.1539	31.05	9.52	40.57	55.79	-15.22	AVG	
3		0.5611	38.42	9.84	48.26	56.00	-7.74	QP	
4		0.5611	26.22	9.84	36.06	46.00	-9.94	AVG	
5		1.3379	40.07	9.58	49.65	56.00	-6.35	QP	
6	*	1.3379	33.72	9.58	43.30	46.00	-2.70	AVG	
7		2.6783	41.49	9.64	51.13	56.00	-4.87	QP	
8		2.6783	32.87	9.64	42.51	46.00	-3.49	AVG	
9		6.6978	40.20	9.73	49.93	60.00	-10.07	QP	
10		6.6978	31.20	9.73	40.93	50.00	-9.07	AVG	
11		12.0599	40.27	9.69	49.96	60.00	-10.04	QP	
12		12.0599	29.16	9.69	38.85	50.00	-11.15	AVG	

Temperature :	26 °C	Relative Humidity :	54%
Pressure :	101kPa	Phase :	N
Test Voltage :	AC 120V/60Hz	Test Mode :	Mode 5

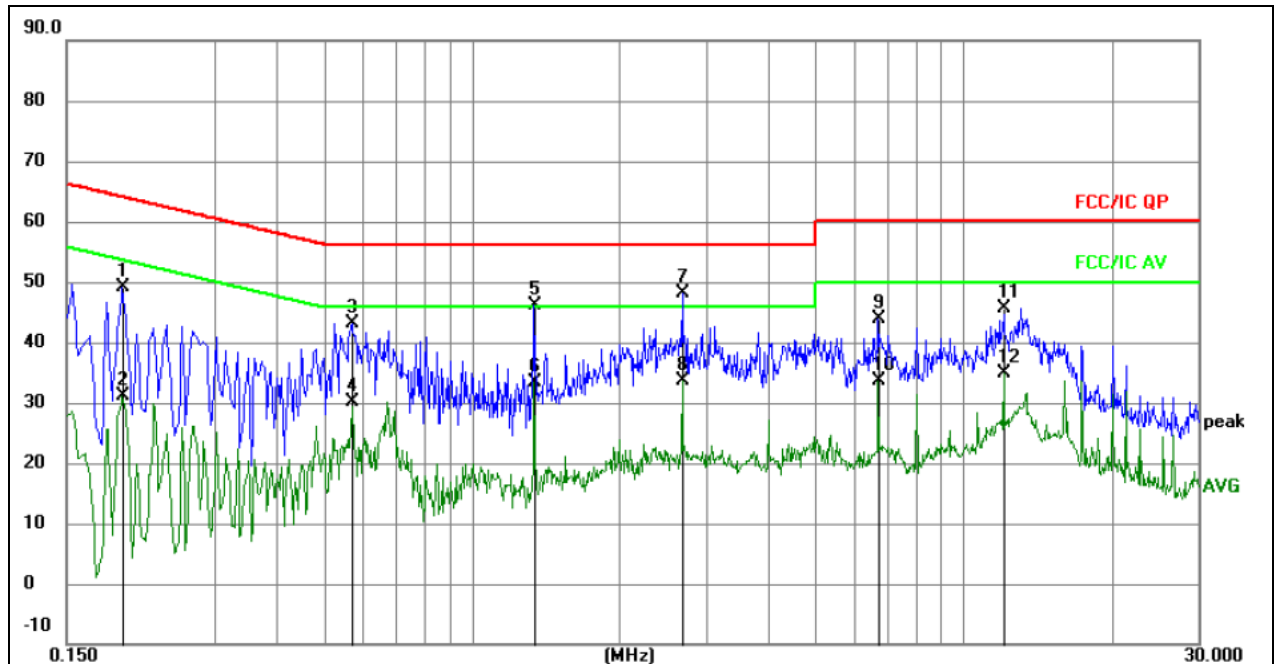
Remark:

1. All readings are Quasi-Peak and Average values.
2. Factor = Insertion Loss + Cable Loss.

No.	Mk.	Freq.	Reading Level	Correct Factor	Measurement	Limit	Over	Detector	Comment
		MHz		dB	dBuV	dBuV	dB		
1		0.1949	39.60	9.47	49.07	63.83	-14.76	QP	
2		0.1949	21.70	9.47	31.17	53.83	-22.66	AVG	
3		0.5730	33.33	9.89	43.22	56.00	-12.78	QP	
4		0.5730	20.20	9.89	30.09	46.00	-15.91	AVG	
5		1.3425	36.62	9.58	46.20	56.00	-9.80	QP	
6		1.3425	23.87	9.58	33.45	46.00	-12.55	AVG	
7	*	2.6835	38.59	9.64	48.23	56.00	-7.77	QP	
8		2.6835	23.89	9.64	33.53	46.00	-12.47	AVG	
9		6.7065	34.26	9.73	43.99	60.00	-16.01	QP	
10		6.7065	23.90	9.73	33.63	50.00	-16.37	AVG	
11		12.0705	35.84	9.69	45.53	60.00	-14.47	QP	
12		12.0705	25.13	9.69	34.82	50.00	-15.18	AVG	

3.2 RADIATED EMISSION MEASUREMENT

3.2.1 APPLICABLE STANDARD

According to FCC Part 15.407(d) and 15.209

3.2.2 CONFORMANCE LIMIT

According to FCC Part 15.407(b)(7): radiated emissions which fall in the restricted bands, as defined in §15.205(a), must also comply with the radiated emission limits specified in §15.209(a) (see §15.205(c)).
 According to FCC Part 15.205, Restricted bands

MHz	MHz	MHz	GHz
0.090-0.110	16.42-16.423	399.9-410	4.5-5.15
10.495-0.505	16.69475-16.69525	608-614	5.35-5.46
2.1735-2.1905	16.80425-16.80475	960-1240	7.25-7.75
4.125-4.128	25.5-25.67	1300-1427	8.025-8.5
4.17725-4.17775	37.5-38.25	1435-1626.5	9.0-9.2
4.20725-4.20775	73-74.6	1645.5-1646.5	9.3-9.5
6.215-6.218	74.8-75.2	1660-1710	10.6-12.7
6.26775-6.26825	123-138	2200-2300	14.47-14.5
8.291-8.294	149.9-150.05	2310-2390	15.35-16.2
8.362-8.366	156.52475-156.52525	2483.5-2500	17.7-21.4
8.37625-8.38675	156.7-156.9	2690-2900	22.01-23.12
8.41425-8.41475	162.0125-167.17	3260-3267	23.6-24.0
12.29-12.293	167.72-173.2	3332-3339	31.2-31.8
12.51975-12.52025	240-285	3345.8-3358	36.43-36.5
12.57675-12.57725	322-335.4	3600-4400	(2)
13.36-13.41			

20dBc in any 100 kHz bandwidth outside the operating frequency band. In case the emission fall within the restricted band specified on 15.205(a), then the 15.209(a) limit in the table below has to be followed.

Restricted Frequency(MHz)	Field Strength ($\mu\text{V}/\text{m}$)	Field Strength ($\text{dB}\mu\text{V}/\text{m}$)	Measurement Distance
0.009~0.490	2400/F(KHz)	20 log ($\mu\text{V}/\text{m}$)	300
0.490~1.705	24000/F(KHz)	20 log ($\mu\text{V}/\text{m}$)	30
1.705~30.0	30	29.5	30
30-88	100	40	3
88-216	150	43.5	3
216-960	200	46	3
Above 960	500	54	3

Limits of Radiated Emission Measurement(Above 1000MHz)

Frequency(MHz)	Class B ($\text{dB}\mu\text{V}/\text{m}$) (at 3M)	
	PEAK	AVERAGE
Above 1000	74	54

Remark :1. Emission level in $\text{dB}\mu\text{V}/\text{m}=20 \log (\mu\text{V}/\text{m})$

2. Measurement was performed at an antenna to the closed point of EUT distance of meters.

3. Distance extrapolation factor = $40 \log (\text{Specific distance}/ \text{test distance})(\text{dB})$;

Limit line=Specific limits($\text{dB}\mu\text{V}$) + distance extrapolation factor.

3.2.3 MEASURING INSTRUMENTS

The Measuring equipment is listed in the section 6.3 of this test report.

3.2.4 TEST CONFIGURATION

(a) For radiated emissions below 30MHz

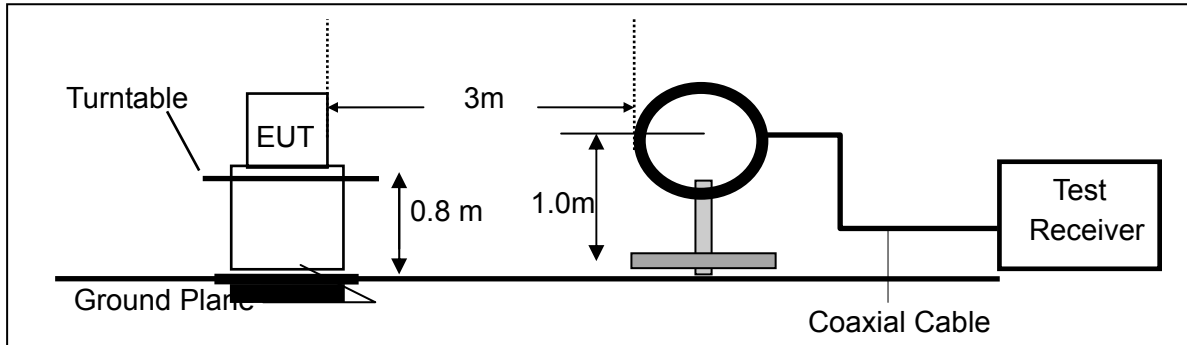

(b) For radiated emissions from 30MHz to 1000MHz

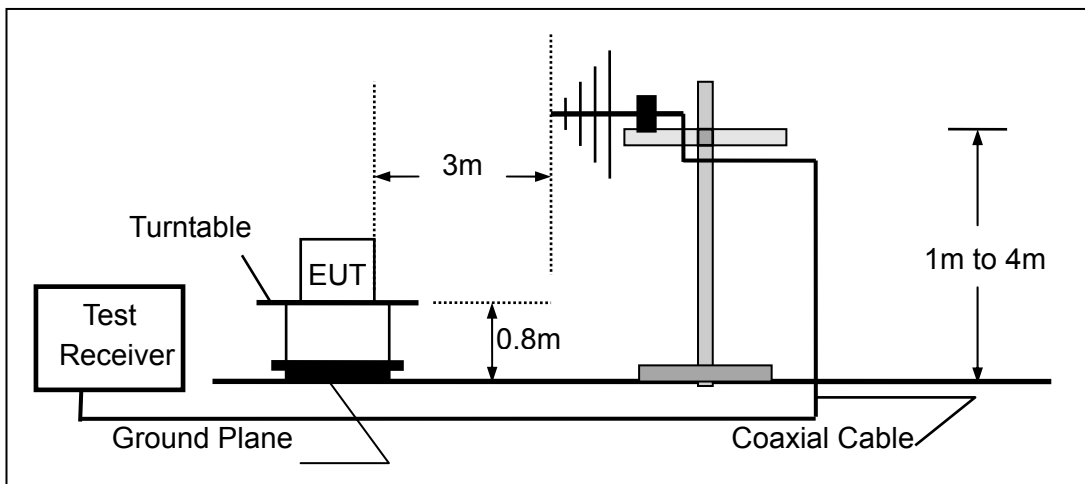

(c) For radiated emissions above 1000MHz

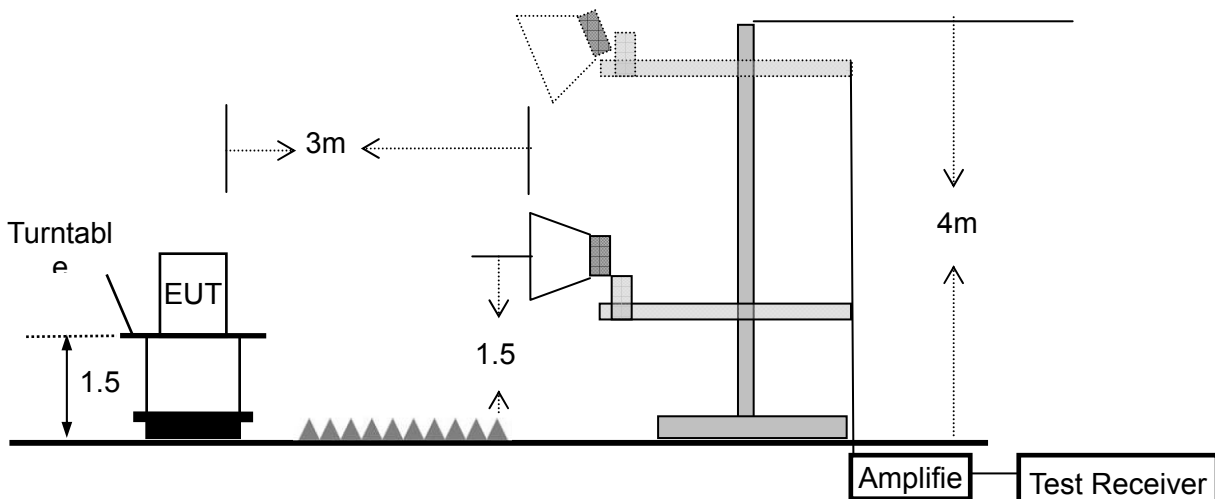

3.2.5 TEST PROCEDURE

The test site semi-anechoic chamber has met the requirement of NSA tolerance 4 dB according to the standards: ANSI C63.10-2013. The test distance is 3m. The setup is according to the requirements in Section 13.1.4.1 of ANSI C63.10-2013 and CAN/CSA-CEI/IEC CISPR 22.

This test is required for any spurious emission that falls in a Restricted Band, as defined in Section 15.205. It must be performed with the highest gain of each type of antenna proposed for use with the EUT.

Use the following spectrum analyzer settings:

Spectrum Parameter	Setting
Attenuation	Auto
Start Frequency	1000 MHz
Stop Frequency	10th carrier harmonic
RB / VB (emission in restricted band)	1 MHz / 1 MHz for Peak, 1 MHz / 10Hz for Average

Receiver Parameter	Setting
Attenuation	Auto
Start ~ Stop Frequency	9kHz~150kHz / RB 200Hz for QP
Start ~ Stop Frequency	150kHz~30MHz / RB 9kHz for QP
Start ~ Stop Frequency	30MHz~1000MHz / RB 120kHz for QP

- The measuring distance of at 3 m shall be used for measurements at frequency up to 1GHz. For frequencies above 1GHz, any suitable measuring distance may be used.
- The EUT was placed on the top of a rotating table 0.8 m for below 1GHz and 1.5m for above 1GHz the ground at a 3 meter. The table was rotated 360 degrees to determine the position of the highest radiation.
- The height of the equipment or of the substitution antenna shall be 0.8 m for below 1GHz and 1.5m for above 1GHz; the height of the test antenna shall vary between 1 m to 4 m. Both horizontal and vertical polarizations of the antenna are set to make the measurement.
- The initial step in collecting conducted emission data is a spectrum analyzer peak detector mode pre-scanning the measurement frequency range. Significant peaks are then marked and then Quasi Peak detector mode re-measured.
- If the Peak Mode measured value compliance with and lower than Quasi Peak Mode Limit, the EUT shall be deemed to meet QP Limits and then no additional QP Mode measurement performed.
- For the actual test configuration, please refer to the related Item –EUT Test Photos.

Note:

Both horizontal and vertical antenna polarities were tested and performed pretest to three orthogonal axis. The worst case emissions were reported

During the radiated emission test, the Spectrum Analyzer was set with the following configurations:

Frequency Band (MHz)	Function	Resolution bandwidth	Video Bandwidth
30 to 1000	QP	120 kHz	300 kHz
Above 1000	Peak	1 MHz	1 MHz
	Average	1 MHz	10 Hz

Note: for the frequency ranges below 30 MHz, a narrower RBW is used for these ranges but the measured value should add a RBW correction factor (RBWCF) where $RBWCF [dB] = 10 \cdot \lg(100 [kHz] / \text{narrower RBW [kHz]})$. , the narrower RBW is 1 kHz and RBWCF is 20 dB for the frequency 9 kHz to 150 kHz, and the narrower RBW is 10 kHz and RBWCF is 10 dB for the frequency 150 kHz to 30 MHz.

3.2.6 TEST RESULTS (9KHZ – 30 MHZ)

Temperature:	26℃	Relative Humidity:	54%
Pressure:	101kPa	Test Voltage :	AC 120V/60Hz
Test Mode :	Mode 5	Polarization :	--

Freq.	Reading	Limit	Margin	State
(MHz)	(dBuV/m)	(dBuV/m)	(dB)	P/F
--	--	--	--	N/A
--	--	--	--	N/A

NOTE:

The amplitude of spurious emissions which are attenuated by more than 20dB below the permissible value has no need to be reported.

Distance extrapolation factor = $40 \log(\text{specific distance}/\text{test distance})$ (dB);

Limit line = specific limits(dBuv) + distance extrapolation factor.

3.2.7 TEST RESULTS (30MHZ – 1GHZ)

Temperature :	26 °C	Relative Humidity :	54%
Pressure :	101 kPa	Polarization :	Horizontal
Test Voltage :	AC 120V/60Hz	Test Mode :	Mode 5

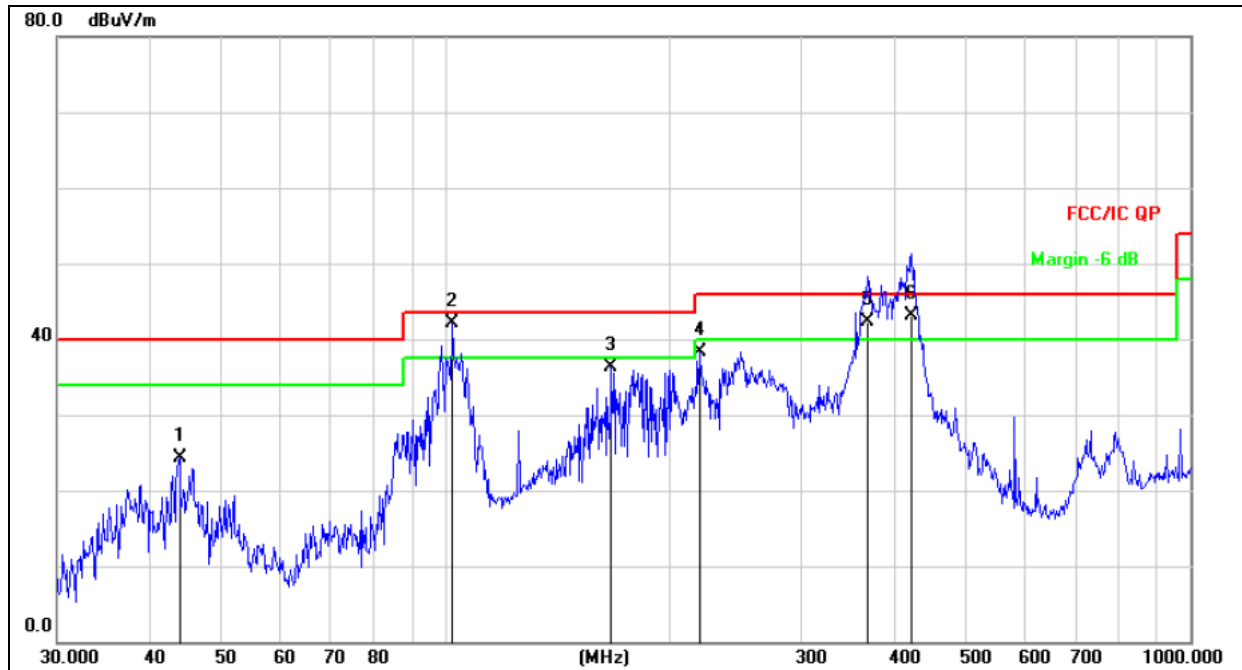

Remark:

Factor = Antenna Factor + Cable Loss – Pre-amplifier.

No.	Mk.	Freq. MHz	Reading Level dBuV	Correct Factor dB	Measure- ment dBuV/m	Limit dB/m	Over dB	Detector
1		43.8119	39.48	-15.20	24.28	40.00	-15.72	QP
2	*	102.0014	58.50	-16.41	42.09	43.50	-1.41	QP
3		166.6514	54.71	-18.43	36.28	43.50	-7.22	QP
4		219.0753	54.24	-15.86	38.38	46.00	-7.62	QP
5	!	368.1116	54.18	-11.82	42.36	46.00	-3.64	QP
6	!	421.7650	53.78	-10.60	43.18	46.00	-2.82	QP

Temperature :	26 °C	Relative Humidity :	54%
Pressure :	101kPa	Polarization :	Vertical
Test Voltage :	AC 120V/60Hz	Test Mode :	Mode 5

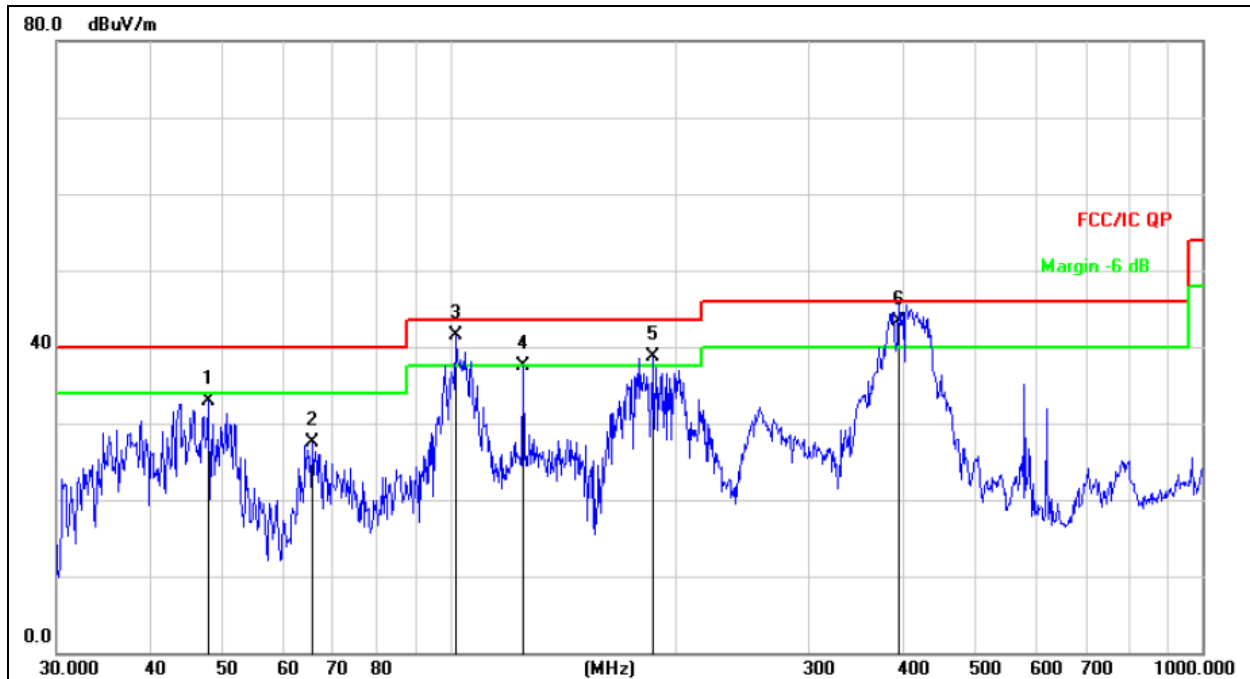

Remark:

Factor = Antenna Factor + Cable Loss – Pre-amplifier.

No.	Mk.	Freq. MHz	Reading Level dBuV	Correct Factor dB	Measure- ment dBuV/m	Limit dB/m	Over dB	Detector
1		47.8260	47.87	-14.97	32.90	40.00	-7.10	QP
2		65.5727	44.61	-17.18	27.43	40.00	-12.57	QP
3	*	102.0014	57.82	-16.41	41.41	43.50	-2.09	QP
4		125.0066	55.38	-17.89	37.49	43.50	-6.01	QP
5	!	186.4409	55.83	-17.17	38.66	43.50	-4.84	QP
6	!	394.8545	54.47	-11.21	43.26	46.00	-2.74	QP

3.2.8 TEST RESULTS (1GHz-40GHz)

Test Mode :	TX(5.1G) - 802.11a
-------------	--------------------

Polar	Frequency	Meter Reading	Cable loss	Antenna Factor	Preamp Factor	Emission Level	Limits	Margin	Detector Type
(H/V)	(MHz)	(dBuV)	(dB)	dB/m	(dB)	(dBuV/m)	(dBuV/m)	(dB)	
Low Channel (5180 MHz)-Above 1G									
Vertical	4434.157	62.24	5.94	35.40	44.00	59.58	68.20	-8.62	Pk
Vertical	4434.157	46.54	5.94	35.40	44.00	43.88	54.00	-10.12	AV
Vertical	10360.362	60.47	8.46	39.75	44.50	64.18	68.20	-4.02	Pk
Vertical	10360.362	42.95	8.46	39.75	44.50	46.66	54.00	-7.34	AV
Vertical	15540.196	61.48	10.12	38.80	44.10	66.3	74.00	-7.7	Pk
Vertical	15540.196	37.51	10.12	38.80	42.70	43.73	54.00	-10.27	AV
Horizontal	4434.521	66.58	5.94	35.18	44.00	63.7	68.20	-4.5	Pk
Horizontal	4434.521	44.16	5.94	35.18	44.00	41.28	54.00	-12.72	AV
Horizontal	10360.623	58.92	8.46	38.71	44.50	61.59	68.20	-6.61	Pk
Horizontal	10360.623	41.02	8.46	38.71	44.50	43.69	54.00	-10.31	AV
Horizontal	15540.865	56.94	10.12	38.38	44.10	61.34	74.00	-12.66	Pk
Horizontal	15540.865	38.81	10.12	38.38	44.10	43.21	54.00	-10.79	AV
middle Channel (5200 MHz)-Above 1G									
Vertical	4592.093	60.23	6.48	36.35	44.05	59.01	74.00	-14.99	Pk
Vertical	4592.093	41.91	6.48	36.35	44.05	40.69	54.00	-13.31	AV
Vertical	10400.424	59.64	8.47	37.88	44.51	61.48	68.20	-6.72	Pk
Vertical	10400.424	42.75	8.47	37.88	44.51	44.59	54.00	-9.41	AV
Vertical	15600.218	56.51	10.12	38.8	44.10	61.33	74.00	-12.67	Pk
Vertical	15600.218	36.62	10.12	38.8	42.70	42.84	54.00	-11.16	AV
Horizontal	4592.691	59.86	6.48	36.37	44.05	58.66	74.00	-15.34	Pk
Horizontal	4592.691	43.13	6.48	36.37	44.05	41.93	54.00	-12.07	AV
Horizontal	10400.114	58.81	8.47	38.64	44.50	61.42	68.20	-6.78	Pk
Horizontal	10400.114	42.25	8.47	38.64	44.50	44.86	54.00	-9.14	AV
Horizontal	15600.187	59.85	10.12	38.38	44.10	64.25	74.00	-9.75	Pk
Horizontal	15600.187	38.77	10.12	38.38	44.10	43.17	54.00	-10.83	AV
High Channel (5240 MHz)-Above 1G									
Vertical	4739.246	61.21	7.10	37.24	43.50	62.05	74.00	-11.95	Pk
Vertical	4739.246	44.46	7.10	37.24	43.50	45.3	54.00	-8.7	AV
Vertical	10480.371	60.57	8.46	37.68	44.50	62.21	68.20	-5.99	Pk
Vertical	10480.371	40.38	8.46	37.68	44.50	42.02	54.00	-11.98	AV
Vertical	15720.359	61.76	10.12	38.8	44.10	66.58	74.00	-7.42	Pk
Vertical	15720.359	39.64	10.12	38.8	42.70	45.86	54.00	-8.14	AV
Horizontal	4739.352	62.25	7.10	37.24	43.50	63.09	74.00	-10.91	Pk
Horizontal	4739.352	43.22	7.10	37.24	43.50	44.06	54.00	-9.94	AV
Horizontal	10480.111	62.55	8.46	38.57	44.50	65.08	68.20	-3.12	Pk
Horizontal	10480.111	43.33	8.46	38.57	44.50	45.86	54.00	-8.14	AV
Horizontal	15720.357	60.76	10.12	38.38	44.10	65.16	74.00	-8.84	Pk
Horizontal	15720.357	42.22	10.12	38.38	44.10	46.62	54.00	-7.38	AV

Note:”

The amplitude of spurious emissions that are attenuated by more than 20dB below the permissible value has no need to be reported.

Emission level (dBuV/m) = 20 log Emission level (uV/m).

Corrected Reading: Antenna Factor + Cable Loss + Read Level - Preamp Factor = Level.

The worst case is Antenna A.

Test Mode :	TX(5.1G) - 802.11n-HT20
-------------	-------------------------

Polar	Frequency	Meter Reading	Cable loss	Antenna Factor	Preamp Factor	Emission Level	Limits	Margin	Detector Type
(H/V)	(MHz)	(dBuV)	(dB)	dB/m	(dB)	(dBuV/m)	(dBuV/m)	(dB)	
Low Channel (5180 MHz)-Above 1G									
Vertical	4434.157	62.22	5.94	35.40	44.00	59.56	68.20	-8.64	Pk
Vertical	4434.157	46.54	5.94	35.40	44.00	43.88	54.00	-10.12	AV
Vertical	10360.362	60.42	8.46	39.75	44.50	64.13	68.20	-4.07	Pk
Vertical	10360.362	42.94	8.46	39.75	44.50	46.65	54.00	-7.35	AV
Vertical	15540.196	61.44	10.12	38.80	44.10	66.26	74.00	-7.74	Pk
Vertical	15540.196	37.57	10.12	38.80	42.70	43.79	54.00	-10.21	AV
Horizontal	4434.521	66.54	5.94	35.18	44.00	63.66	68.20	-4.54	Pk
Horizontal	4434.521	44.17	5.94	35.18	44.00	41.29	54.00	-12.71	AV
Horizontal	10360.623	58.92	8.46	38.71	44.50	61.59	68.20	-6.61	Pk
Horizontal	10360.623	41.04	8.46	38.71	44.50	43.71	54.00	-10.29	AV
Horizontal	15540.865	56.96	10.12	38.38	44.10	61.36	74.00	-12.64	Pk
Horizontal	15540.865	38.82	10.12	38.38	44.10	43.22	54.00	-10.78	AV
middle Channel (5200 MHz)-Above 1G									
Vertical	4592.093	60.26	6.48	36.35	44.05	59.04	74.00	-14.96	Pk
Vertical	4592.093	41.94	6.48	36.35	44.05	40.72	54.00	-13.28	AV
Vertical	10400.424	59.67	8.47	37.88	44.51	61.51	68.20	-6.69	Pk
Vertical	10400.424	42.77	8.47	37.88	44.51	44.61	54.00	-9.39	AV
Vertical	15600.218	56.54	10.12	38.8	44.10	61.36	74.00	-12.64	Pk
Vertical	15600.218	36.65	10.12	38.8	42.70	42.87	54.00	-11.13	AV
Horizontal	4592.691	59.86	6.48	36.37	44.05	58.66	74.00	-15.34	Pk
Horizontal	4592.691	43.18	6.48	36.37	44.05	41.98	54.00	-12.02	AV
Horizontal	10400.114	58.83	8.47	38.64	44.50	61.44	68.20	-6.76	Pk
Horizontal	10400.114	42.25	8.47	38.64	44.50	44.86	54.00	-9.14	AV
Horizontal	15600.187	59.86	10.12	38.38	44.10	64.26	74.00	-9.74	Pk
Horizontal	15600.187	38.73	10.12	38.38	44.10	43.13	54.00	-10.87	AV
High Channel (5240 MHz)-Above 1G									
Vertical	4739.246	61.27	7.10	37.24	43.50	62.11	74.00	-11.89	Pk
Vertical	4739.246	44.42	7.10	37.24	43.50	45.26	54.00	-8.74	AV
Vertical	10480.371	60.55	8.46	37.68	44.50	62.19	68.20	-6.01	Pk
Vertical	10480.371	40.31	8.46	37.68	44.50	41.95	54.00	-12.05	AV
Vertical	15720.359	61.71	10.12	38.8	44.10	66.53	74.00	-7.47	Pk
Vertical	15720.359	39.64	10.12	38.8	42.70	45.86	54.00	-8.14	AV
Horizontal	4739.352	62.27	7.10	37.24	43.50	63.11	74.00	-10.89	Pk
Horizontal	4739.352	43.21	7.10	37.24	43.50	44.05	54.00	-9.95	AV
Horizontal	10480.111	62.61	8.46	38.57	44.50	65.14	68.20	-3.06	Pk
Horizontal	10480.111	43.31	8.46	38.57	44.50	45.84	54.00	-8.16	AV
Horizontal	15720.357	60.75	10.12	38.38	44.10	65.15	74.00	-8.85	Pk
Horizontal	15720.357	42.36	10.12	38.38	44.10	46.76	54.00	-7.24	AV

Note: PK value is lower than the Average value limit, So average didn't record.

The 26.5-40G amplitude of spurious emissions that are attenuated by more than 20dB below the permissible value has no need to be reported.

Emission level (dBuV/m) = 20 log Emission level (uV/m).

Corrected Reading: Antenna Factor + Cable Loss + Read Level - Preamp Factor = Level.

Test Mode is MIMO Mode.

Test Mode :	TX(5.1G) - 802.11n-HT40
-------------	-------------------------

Polar	Frequency	Meter Reading	Cable loss	Antenna Factor	Preamp Factor	Emission Level	Limits	Margin	Detector Type
(H/V)	(MHz)	(dBuV)	(dB)	dB/m	(dB)	(dBuV/m)	(dBuV/m)	(dB)	
Low Channel (5190 MHz)-Above 1G									
Vertical	4434.157	62.25	5.94	35.40	44.00	59.59	74.00	-14.41	Pk
Vertical	4434.157	46.57	5.94	35.40	44.00	43.91	54.00	-10.09	AV
Vertical	10380.362	60.45	8.46	39.75	44.50	64.16	68.20	-4.04	Pk
Vertical	10380.362	42.98	8.46	39.75	44.50	46.69	54.00	-7.31	AV
Vertical	15570.196	61.45	10.12	38.80	44.10	66.27	74.00	-7.73	Pk
Vertical	15570.196	37.56	10.12	38.80	42.70	43.78	54.00	-10.22	AV
Horizontal	4434.521	66.53	5.94	35.18	44.00	63.65	74.00	-10.35	Pk
Horizontal	4434.521	44.26	5.94	35.18	44.00	41.38	54.00	-12.62	AV
Horizontal	10380.623	58.87	8.46	38.71	44.50	61.54	68.20	-6.66	Pk
Horizontal	10380.623	41.06	8.46	38.71	44.50	43.73	54.00	-10.27	AV
Horizontal	15570.865	56.91	10.12	38.38	44.10	61.31	74.00	-12.69	Pk
Horizontal	15570.865	38.86	10.12	38.38	44.10	43.26	54.00	-10.74	AV
High Channel (5230 MHz)-Above 1G									
Vertical	4739.246	61.35	7.10	37.24	43.50	62.19	74.00	-11.81	Pk
Vertical	4739.246	44.41	7.10	37.24	43.50	45.25	54.00	-8.75	AV
Vertical	10460.371	60.25	8.46	37.68	44.50	61.89	68.20	-6.31	Pk
Vertical	10460.371	44.23	8.46	37.68	44.50	45.87	54.00	-8.13	AV
Vertical	15690.359	61.61	10.12	38.8	44.10	66.43	74.00	-7.57	Pk
Vertical	15690.359	39.61	10.12	38.8	42.70	45.83	54.00	-8.17	AV
Horizontal	4739.352	62.25	7.10	37.24	43.50	63.09	74.00	-10.91	Pk
Horizontal	4739.352	43.13	7.10	37.24	43.50	43.97	54.00	-10.03	AV
Horizontal	10460.111	62.25	8.46	38.57	44.50	64.78	68.20	-3.42	Pk
Horizontal	10460.111	43.36	8.46	38.57	44.50	45.89	54.00	-8.11	AV
Horizontal	15690.357	60.72	10.12	38.38	44.10	65.12	74.00	-8.88	Pk
Horizontal	15690.357	42.25	10.12	38.38	44.10	46.65	54.00	-7.35	AV

Note: PK value is lower than the Average value limit, So average didn't record.

The 26.5-40G amplitude of spurious emissions that are attenuated by more than 20dB below the permissible value has no need to be reported.

Emission level (dBuV/m) = 20 log Emission level (uV/m).

Corrected Reading: Antenna Factor + Cable Loss + Read Level - Preamp Factor = Level.

Test Mode is MIMO Mode.

Test Mode :	TX(5.1G) - 802.11ac-HT20
-------------	--------------------------

Polar	Frequency	Meter Reading	Cable loss	Antenna Factor	Preamp Factor	Emission Level	Limits	Margin	Detector Type
(H/V)	(MHz)	(dBuV)	(dB)	dB/m	(dB)	(dBuV/m)	(dBuV/m)	(dB)	
Low Channel (5180 MHz)-Above 1G									
Vertical	4434.157	62.21	5.94	35.40	44.00	59.55	68.20	-8.65	Pk
Vertical	4434.157	46.51	5.94	35.40	44.00	43.85	54.00	-10.15	AV
Vertical	10360.367	60.45	8.46	39.75	44.50	64.16	68.20	-4.04	Pk
Vertical	10360.367	42.92	8.46	39.75	44.50	46.63	54.00	-7.37	AV
Vertical	15540.195	61.41	10.12	38.80	44.10	66.23	74.00	-7.77	Pk
Vertical	15540.195	37.56	10.12	38.80	42.70	43.78	54.00	-10.22	AV
Horizontal	4434.524	66.57	5.94	35.18	44.00	63.69	68.20	-4.51	Pk
Horizontal	4434.524	44.12	5.94	35.18	44.00	41.24	54.00	-12.76	AV
Horizontal	10360.627	58.91	8.46	38.71	44.50	61.58	68.20	-6.62	Pk
Horizontal	10360.627	35.61	8.46	38.71	44.50	38.28	54.00	-15.72	AV
Horizontal	15540.865	56.96	10.12	38.38	44.10	61.36	74.00	-12.64	Pk
Horizontal	15540.865	38.87	10.12	38.38	44.10	43.27	54.00	-10.73	AV
middle Channel (5200 MHz)-Above 1G									
Vertical	4592.098	60.31	6.48	36.35	44.05	59.09	74.00	-14.91	Pk
Vertical	4592.098	41.84	6.48	36.35	44.05	40.62	54.00	-13.38	AV
Vertical	10400.428	59.55	8.47	37.88	44.51	61.39	68.20	-6.81	Pk
Vertical	10400.428	42.71	8.47	37.88	44.51	44.55	54.00	-9.45	AV
Vertical	15600.214	56.52	10.12	38.8	44.10	61.34	74.00	-12.66	Pk
Vertical	15600.214	36.65	10.12	38.8	42.70	42.87	54.00	-11.13	AV
Horizontal	4592.699	59.81	6.48	36.37	44.05	58.61	74.00	-15.39	Pk
Horizontal	4592.699	43.12	6.48	36.37	44.05	41.92	54.00	-12.08	AV
Horizontal	10400.113	58.84	8.47	38.64	44.50	61.45	68.20	-6.75	Pk
Horizontal	10400.113	42.22	8.47	38.64	44.50	44.83	54.00	-9.17	AV
Horizontal	15600.187	59.85	10.12	38.38	44.10	64.25	74.00	-9.75	Pk
Horizontal	15600.187	38.74	10.12	38.38	44.10	43.14	54.00	-10.86	AV
High Channel (5240 MHz)-Above 1G									
Vertical	4739.249	61.22	7.10	37.24	43.50	62.06	74.00	-11.94	Pk
Vertical	4739.249	44.43	7.10	37.24	43.50	45.27	54.00	-8.73	AV
Vertical	10480.375	60.55	8.46	37.68	44.50	62.19	68.20	-6.01	Pk
Vertical	10480.375	40.36	8.46	37.68	44.50	42	54.00	-12	AV
Vertical	15720.358	61.78	10.12	38.8	44.10	66.6	74.00	-7.4	Pk
Vertical	15720.358	39.53	10.12	38.8	42.70	45.75	54.00	-8.25	AV
Horizontal	4739.354	62.27	7.10	37.24	43.50	63.11	74.00	-10.89	Pk
Horizontal	4739.354	43.38	7.10	37.24	43.50	44.22	54.00	-9.78	AV
Horizontal	10480.111	62.65	8.46	38.57	44.50	65.18	68.20	-3.02	Pk
Horizontal	10480.111	43.36	8.46	38.57	44.50	45.89	54.00	-8.11	AV
Horizontal	15720.356	60.67	10.12	38.38	44.10	65.07	74.00	-8.93	Pk
Horizontal	15720.353	42.39	10.12	38.38	44.10	46.79	54.00	-7.21	AV

Note: PK value is lower than the Average value limit, So average didn't record.

The 26.5-40G amplitude of spurious emissions that are attenuated by more than 20dB below the permissible value has no need to be reported.

Emission level (dBuV/m) = 20 log Emission level (uV/m).

Corrected Reading: Antenna Factor + Cable Loss + Read Level - Preamp Factor = Level.

Test Mode is MIMO Mode.

Test Mode :	TX(5.1G) - 802.11ac-HT40
-------------	--------------------------

Polar	Frequency	Meter Reading	Cable loss	Antenna Factor	Preamp Factor	Emission Level	Limits	Margin	Detector Type
(H/V)	(MHz)	(dBuV)	(dB)	dB/m	(dB)	(dBuV/m)	(dBuV/m)	(dB)	
Low Channel (5190 MHz)-Above 1G									
Vertical	4434.155	62.35	5.94	35.40	44.00	59.69	68.20	-8.51	Pk
Vertical	4434.155	46.55	5.94	35.40	44.00	43.89	54.00	-10.11	AV
Vertical	10380.367	60.46	8.46	39.75	44.50	64.17	68.20	-4.03	Pk
Vertical	10380.367	42.88	8.46	39.75	44.50	46.59	54.00	-7.41	AV
Vertical	15570.193	61.45	10.12	38.80	44.10	66.27	74.00	-7.73	Pk
Vertical	15570.193	37.56	10.12	38.80	42.70	43.78	54.00	-10.22	AV
Horizontal	4434.528	66.59	5.94	35.18	44.00	63.71	68.20	-4.49	Pk
Horizontal	4434.528	44.35	5.94	35.18	44.00	41.47	54.00	-12.53	AV
Horizontal	10380.623	58.87	8.46	38.71	44.50	61.54	68.20	-6.66	Pk
Horizontal	10380.623	41.08	8.46	38.71	44.50	43.75	54.00	-10.25	AV
Horizontal	15570.869	56.65	10.12	38.38	44.10	61.05	74.00	-12.95	Pk
Horizontal	15570.869	38.86	10.12	38.38	44.10	43.26	54.00	-10.74	AV
High Channel (5230 MHz)-Above 1G									
Vertical	4739.244	61.33	7.10	37.24	43.50	62.17	74.00	-11.83	Pk
Vertical	4739.244	44.46	7.10	37.24	43.50	45.3	54.00	-8.7	AV
Vertical	10460.377	60.27	8.46	37.68	44.50	61.91	68.20	-6.29	Pk
Vertical	10460.377	40.43	8.46	37.68	44.50	42.07	54.00	-11.93	AV
Vertical	15690.352	61.67	10.12	38.8	44.10	66.49	74.00	-7.51	Pk
Vertical	15690.356	39.69	10.12	38.8	42.70	45.91	54.00	-8.09	AV
Horizontal	4739.352	62.26	7.10	37.24	43.50	63.1	74.00	-10.9	Pk
Horizontal	4739.352	43.14	7.10	37.24	43.50	43.98	54.00	-10.02	AV
Horizontal	10460.115	35.62	8.46	38.57	44.50	38.15	68.20	-30.05	Pk
Horizontal	10460.115	43.26	8.46	38.57	44.50	45.79	54.00	-8.21	AV
Horizontal	15690.353	60.75	10.12	38.38	44.10	65.15	74.00	-8.85	Pk
Horizontal	15690.353	42.25	10.12	38.38	44.10	46.65	54.00	-7.35	AV

Note: PK value is lower than the Average value limit, So average didn't record.

The 26.5-40G amplitude of spurious emissions that are attenuated by more than 20dB below the permissible value has no need to be reported.

Emission level (dBuV/m) = 20 log Emission level (uV/m).

Corrected Reading: Antenna Factor + Cable Loss + Read Level - Preamp Factor = Level.

Test Mode is MIMO Mode.

Test Mode :	TX(5.1G) - 802.11ac-HT80
-------------	--------------------------

Polar	Frequency	Meter Reading	Cable loss	Antenna Factor	Preamp Factor	Emission Level	Limits	Margin	Detector Type
(H/V)	(MHz)	(dBuV)	(dB)	dB/m	(dB)	(dBuV/m)	(dBuV/m)	(dB)	
(5210 MHz)-Above 1G									
Vertical	4434.157	62.25	5.94	35.40	44.00	59.59	68.20	-8.61	Pk
Vertical	4434.157	46.57	5.94	35.40	44.00	43.91	54.00	-10.09	AV
Vertical	10420.361	60.45	8.46	39.75	44.50	64.16	68.20	-4.04	Pk
Vertical	10420.361	42.99	8.46	39.75	44.50	46.7	54.00	-7.3	AV
Vertical	15630.193	61.45	10.12	38.80	44.10	66.27	74.00	-7.73	Pk
Vertical	15630.193	37.56	10.12	38.80	42.70	43.78	54.00	-10.22	AV
Horizontal	4434.157	66.58	5.94	35.18	44.00	63.7	68.20	-4.5	Pk
Horizontal	4434.157	44.25	5.94	35.18	44.00	41.37	54.00	-12.63	AV
Horizontal	10420.366	58.84	8.46	38.71	44.50	61.51	68.20	-6.69	Pk
Horizontal	10420.366	41.05	8.46	38.71	44.50	43.72	54.00	-10.28	AV
Horizontal	15630.194	56.91	10.12	38.38	44.10	61.31	74.00	-12.69	Pk
Horizontal	15630.194	38.85	10.12	38.38	44.10	43.25	54.00	-10.75	AV

Note: PK value is lower than the Average value limit, So average didn't record.

The 26.5-40G amplitude of spurious emissions that are attenuated by more than 20dB below the permissible value has no need to be reported.

Emission level (dBuV/m) = 20 log Emission level (uV/m).

Corrected Reading: Antenna Factor + Cable Loss + Read Level - Preamp Factor = Level.

Test Mode is MIMO Mode.

4. POWER SPECTRAL DENSITY TEST

4.1 APPLIED PROCEDURES / LIMIT

According to FCC §15.407(a)(3)

For the band 5.15-5.25 GHz,

(i) For an outdoor access point operating in the band 5.15-5.25 GHz, the maximum power spectral density shall not exceed 17 dBm in any 1 megahertz band. If transmitting antennas of directional gain greater than 6 dBi are used, both the maximum conducted output power and the maximum power spectral density shall be reduced by the amount in dB that the directional gain of the antenna exceeds 6 dBi. The maximum e.i.r.p. at any elevation angle above 30 degrees as measured from the horizon must not exceed 125 mW (21 dBm).

(ii) For an indoor access point operating in the band 5.15-5.25 GHz, the maximum power spectral density shall not exceed 17 dBm in any 1 megahertz band. If transmitting antennas of directional gain greater than 6 dBi are used, both the maximum conducted output power and the maximum power spectral density shall be reduced by the amount in dB that the directional gain of the antenna exceeds 6 dBi.

(iii) For fixed point-to-point access points operating in the band 5.15-5.25 GHz, the maximum power spectral density shall not exceed 17 dBm in any 1 megahertz band. Fixed point-to-point U-NII devices may employ antennas with directional gain up to 23 dBi without any corresponding reduction in the maximum conducted output power or maximum power spectral density. For fixed point-to-point transmitters that employ a directional antenna gain greater than 23 dBi, a 1 dB reduction in maximum conducted output power and maximum power spectral density is required for each 1 dB of antenna gain in excess of 23 dBi. Fixed, point-to-point operations exclude the use of point-to-multipoint systems, omnidirectional applications, and multiple collocated transmitters transmitting the same information. The operator of the U-NII device, or if the equipment is professionally installed, the installer, is responsible for ensuring that systems employing high gain directional antennas are used exclusively for fixed, point-to-point operations.

(iv) For client devices in the 5.15-5.25 GHz band, the maximum power spectral density shall not exceed 11 dBm in any 1 megahertz band. If transmitting antennas of directional gain greater than 6 dBi are used, both the maximum conducted output power and the maximum power spectral density shall be reduced by the amount in dB that the directional gain of the antenna exceeds 6 dBi.

For the band 5.725-5.85 GHz

(3) For the band 5.725-5.85 GHz, the maximum power spectral density shall not exceed 30 dBm in any 500-kHz band. If transmitting antennas of directional gain greater than 6 dBi are used, both the maximum conducted output power and the maximum power spectral density shall be reduced by the amount in dB that the directional gain of the antenna exceeds 6 dBi.

4.2 TEST PROCEDURE

For devices operating in the bands 5.15-5.25 GHz, 5.25-5.35 GHz, and 5.47-5.725 GHz, the above procedures make use of 1 MHz RBW to satisfy directly the 1 MHz reference bandwidth specified in § 15.407(a)(5). For devices operating in the band 5.725-5.85 GHz, the rules specify a measurement bandwidth of 500 kHz. Many spectrum analyzers do not have 500 kHz RBW, thus a narrower RBW may need to be used. The rules permit the use of a RBWs less than 1 MHz, or 500 kHz, “provided that the measured power is integrated over the full reference bandwidth” to show the total power over the specified measurement bandwidth (i.e., 1 MHz, or 500 kHz). If measurements are performed using a reduced resolution bandwidth (< 1 MHz, or < 500 kHz) and integrated over 1 MHz, or 500 KHz bandwidth, the following adjustments to the procedures apply:

- a) Set $RBW \geq 1/T$, where T is defined in section II.B.I.a).
- b) Set $VBW \geq 3 RBW$.
- c) If measurement bandwidth of Maximum PSD is specified in 500 kHz, add $10\log(500\text{kHz}/RBW)$ to the measured result, whereas RBW (< 500 KHz) is the reduced resolution bandwidth of the spectrum analyzer set during measurement.
- d) If measurement bandwidth of Maximum PSD is specified in 1 MHz, add $10\log(1\text{MHz}/RBW)$ to the measured result, whereas RBW (< 1 MHz) is the reduced resolution bandwidth of spectrum analyzer set during measurement.
- e) Care must be taken to ensure that the measurements are performed during a period of continuous transmission or are corrected upward for duty cycle.

Note: As a practical matter, it is recommended to use reduced RBW of 100 KHz for the sections 5.c) and 5.d) above, since RBW=100 KHZ is available on nearly all spectrum analyzers.

4.3 DEVIATION FROM STANDARD

No deviation.

4.4 TEST SETUP

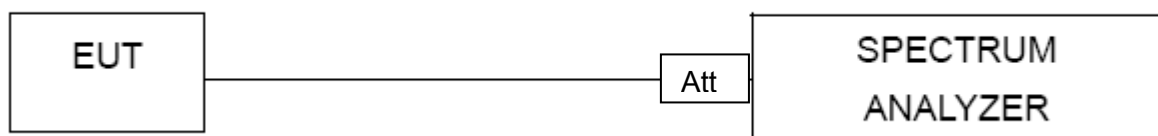

4.5 EUT OPERATION CONDITIONS

The EUT tested system was configured as the statements of 2.1 Unless otherwise a special operating condition is specified in the follows during the testing.

4.6 TEST RESULTS

Temperature :	26 °C	Relative Humidity :	54%
Pressure :	101kPa	Test Voltage :	AC 120V/60Hz
Test Mode :	TX Frequency U-NII-1 (5180-5240MHz)		

Note: A(B) Represent the value of antenna A and B, The worst data is Antenna B, only shown Antenna B Plot.

Mode	Frequency	Measured Power Density (dBm/MHz)			Limit (dBm/MHz)	Result
		ANT A	ANT B	Total		
802.11 a	5180 MHz	5.750	5.883	/	17	PASS
	5200 MHz	4.951	6.535	/	17	PASS
	5240 MHz	4.400	4.919	/	17	PASS
802.11 n20	5180 MHz	4.900	5.090	8.006	17	PASS
	5200 MHz	4.688	5.541	8.146	17	PASS
	5240 MHz	2.590	4.713	6.790	17	PASS
802.11 n40	5190 MHz	3.449	3.397	6.433	17	PASS
	5230 MHz	2.872	2.611	5.754	17	PASS
802.11 AC20	5180 MHz	4.532	4.829	7.693	17	PASS
	5200 MHz	4.397	5.342	7.905	17	PASS
	5240 MHz	2.681	4.450	6.665	17	PASS
802.11 AC40	5190 MHz	3.135	2.517	5.847	17	PASS
	5230 MHz	2.609	1.787	5.228	17	PASS
802.11 AC80	5210 MHz	1.291	1.754	4.539	17	PASS

(802.11a) PSD plot on channel 36

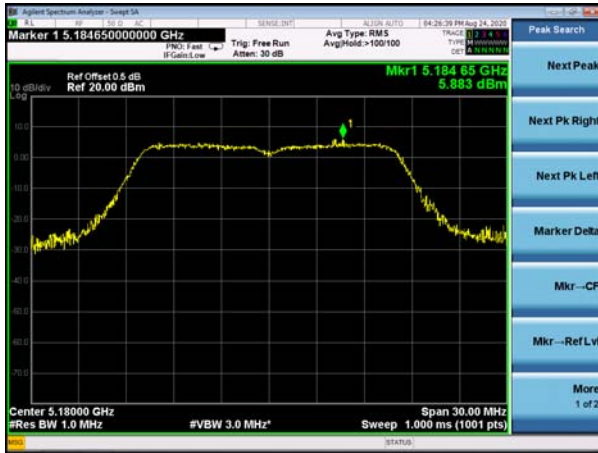

(802.11n20) PSD plot on channel 36



(802.11a) PSD plot on channel 40



(802.11n20) PSD plot on channel 40



(802.11a) PSD plot on channel 48



(802.11n20) PSD plot on channel 48



(802.11n40) PSD plot on channel 38



(802.11ac20) PSD plot on channel 36



(802.11n40) PSD plot on channel 46

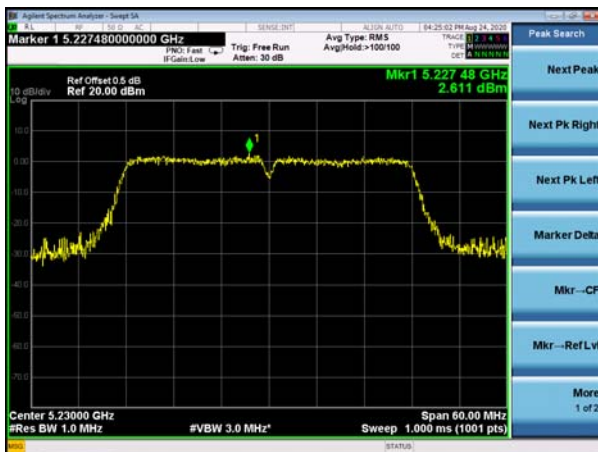

(802.11ac20) PSD plot on channel 40

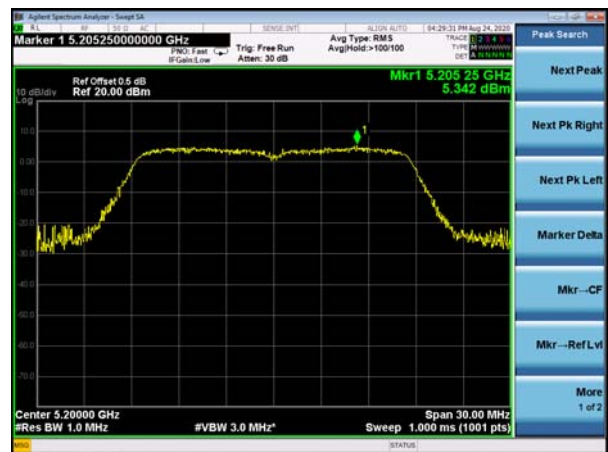

(802.11ac20) PSD plot on channel 48

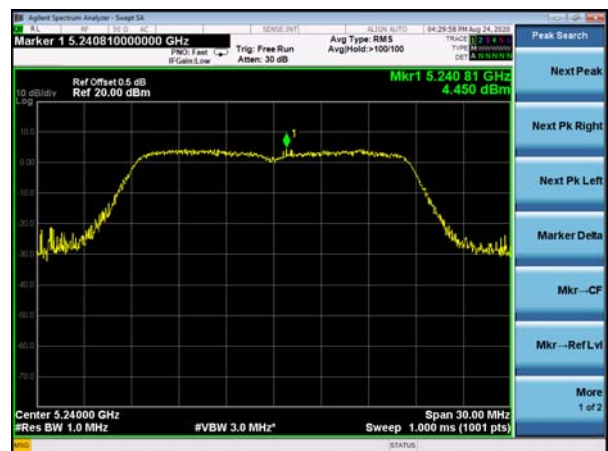

(802.11ac40) PSD plot on channel 38



(802.11ac80) PSD plot on channel 42



(802.11ac40) PSD plot on channel 46



5. 26DB&99% EMISSION BANDWIDTH

5.1 APPLIED PROCEDURES / LIMIT

The maximum power spectral density is measured as a conducted emission by direct connection of a calibrated test instrument to the equipment under test. If the device cannot be connected directly, alternative techniques acceptable to the Commission may be used. Measurements in the 5.725-5.85 GHz band are made over a reference bandwidth of 500 kHz or the 26 dB emission bandwidth of the device, whichever is less. Measurements in the 5.15-5.25 GHz, 5.25-5.35 GHz, and the 5.47-5.725 GHz bands are made over a bandwidth of 1 MHz or the 26 dB emission bandwidth of the device, whichever is less. A narrower resolution bandwidth can be used, provided that the measured power is integrated over the full reference bandwidth.

5.2 TEST PROCEDURE

- a) Set RBW = approximately 1% of the emission bandwidth.
- b) Set the VBW > RBW.
- c) Detector = Peak.
- d) Trace mode = max hold.
- e) Measure the maximum width of the emission that is 26 dB down from the maximum of the emission. Compare this with the RBW setting of the analyzer. Readjust RBW and repeat measurement as needed until the RBW/EBW ratio is approximately 1%.

The following procedure shall be used for measuring (99 %) power bandwidth:

1. Set center frequency to the nominal EUT channel center frequency.
2. Set span = 1.5 times to 5.0 times the OBW.
3. Set RBW = 1 % to 5 % of the OBW
4. Set VBW $\geq 3 \cdot$ RBW
5. Video averaging is not permitted. Where practical, a sample detection and single sweep mode shall be used. Otherwise, peak detection and max hold mode (until the trace stabilizes) shall be used.
6. Use the 99 % power bandwidth function of the instrument (if available).
7. If the instrument does not have a 99 % power bandwidth function, the trace data points are recovered and directly summed in power units. The recovered amplitude data points, beginning at the lowest frequency, are placed in a running sum until 0.5 % of the total is reached; that frequency is recorded as the lower frequency. The process is repeated until 99.5 % of the total is reached; that frequency is recorded as the upper frequency. The 99% occupied bandwidth is the difference between these two frequencies.

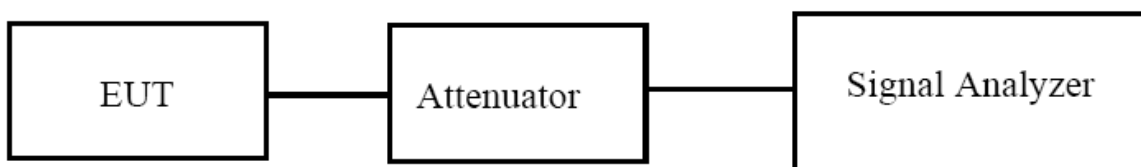

5.3 EUT OPERATION CONDITIONS

The EUT tested system was configured as the statements of 2.4 Unless otherwise a special operating condition is specified in the follows during the testing.

5.4 TEST RESULTS

Temperature :	26 °C	Relative Humidity :	54%
Pressure :	101kPa	Test Voltage :	AC 120V/60Hz
Test Mode :	TX Frequency U-NII-1 (5180-5240MHz)		

Note: A(B) Represent the value of antenna A and B, The worst data is Antenna B ,only shown Antenna B Plot.

Mode	Channel	Frequency (MHz)	99% bandwidth(MHz)	26dB bandwidth (MHz)	Limit MHz	Result
			ANT A	ANT A		
802.11a	CH36	5180	17.679	22.20	N/A	Pass
	CH40	5200	17.511	22.27	N/A	Pass
	CH48	5240	17.544	22.33	N/A	Pass
802.11 n20	CH36	5180	18.366	25.46	N/A	Pass
	CH40	5200	18.267	30.11	N/A	Pass
	CH48	5240	18.346	26.33	N/A	Pass
802.11 n40	CH 38	5190	37.226	53.17	N/A	Pass
	CH 46	5230	37.018	45.16	N/A	Pass
802.11 AC20	CH36	5180	18.399	30.97	N/A	Pass
	CH40	5200	18.366	30.37	N/A	Pass
	CH48	5240	18.202	22.22	N/A	Pass
802.11 AC40	CH 38	5190	36.948	48.78	N/A	Pass
	CH 46	5230	37.097	47.85	N/A	Pass
802.11 AC80	CH 42	5210	75.733	99.53	N/A	Pass

Mode	Channel	Frequency (MHz)	99% bandwidth(MHz)	26dB bandwidth (MHz)	Limit MHz	Result
			ANT B	ANT B		
802.11a	CH36	5180	17.870	26.65	N/A	Pass
	CH40	5200	17.754	26.45	N/A	Pass
	CH48	5240	17.678	22.53	N/A	Pass
802.11 n20	CH36	5180	18.620	32.29	N/A	Pass
	CH40	5200	18.308	31.57	N/A	Pass
	CH48	5240	18.436	26.98	N/A	Pass
802.11 n40	CH 38	5190	37.327	54.72	N/A	Pass
	CH 46	5230	37.413	56.06	N/A	Pass
802.11 AC20	CH36	5180	18.508	31.97	N/A	Pass
	CH40	5200	18.535	32.64	N/A	Pass
	CH48	5240	18.420	26.79	N/A	Pass
802.11 AC40	CH 38	5190	36.957	51.13	N/A	Pass
	CH 46	5230	37.133	51.34	N/A	Pass
802.11 AC80	CH 42	5210	75.727	102.6	N/A	Pass

Test plot

(802.11a) 26dB&99%Bandwidth plot on channel 36

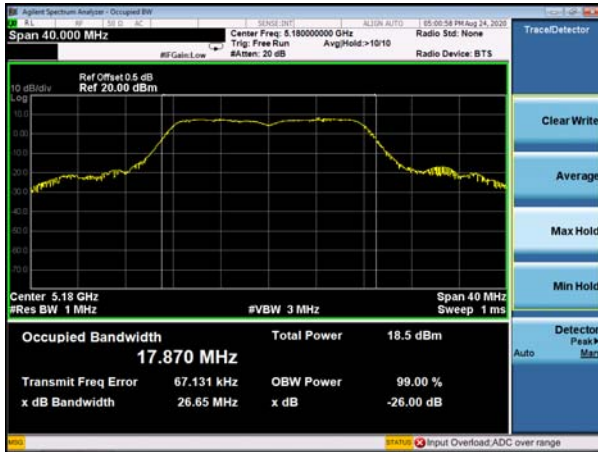

(802.11 n20) 26dB&99%Bandwidth plot on channel 36

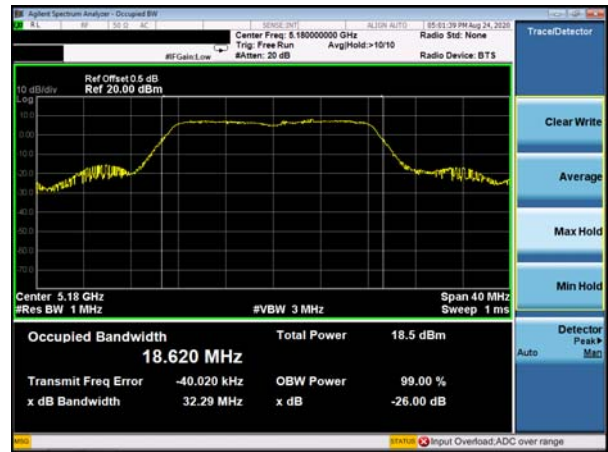

(802.11a) 26dB&99%Bandwidth plot on channel 40

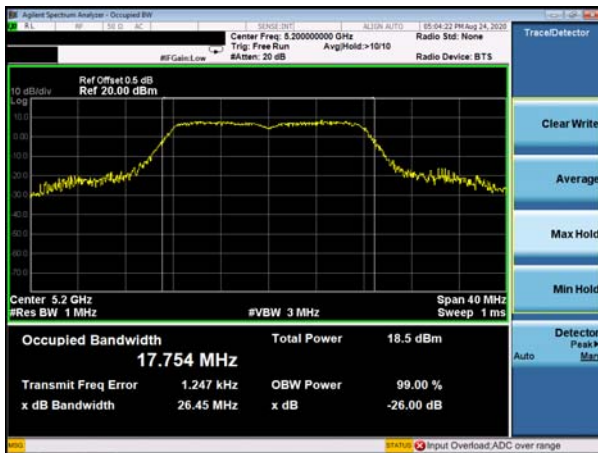

(802.11 n20) 26dB&99%Bandwidth plot on channel 40

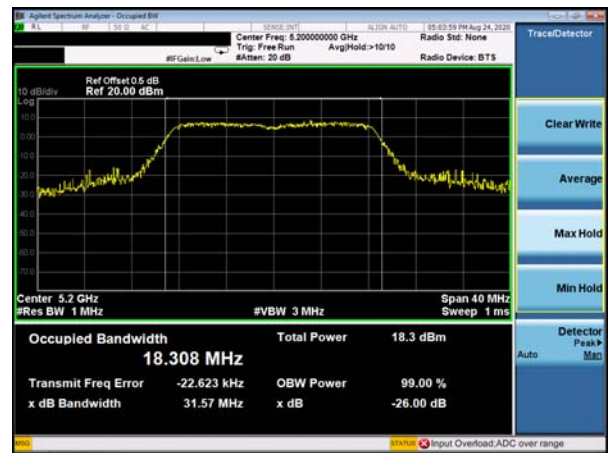

(802.11a) 26dB&99%Bandwidth plot on channel 48

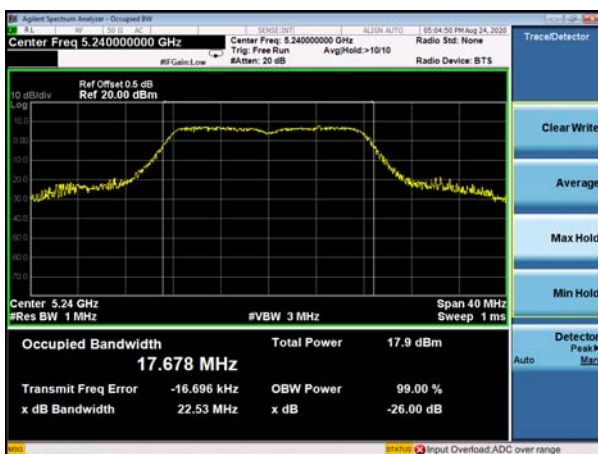

(802.11 n20) 26dB&99%Bandwidth plot on channel 48

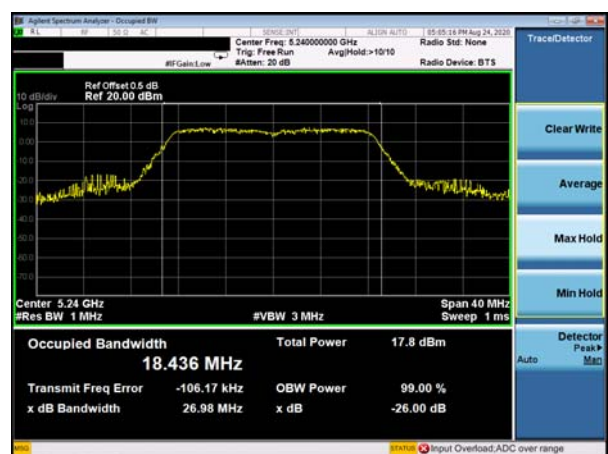

Test plot

(802.11 n40) 26dB&99%Bandwidth plot on channel 38

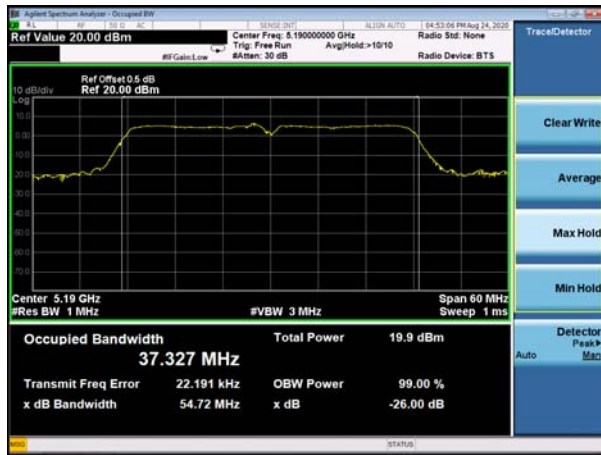

(802.11 AC20) 26dB&99%Bandwidth plot on channel 36

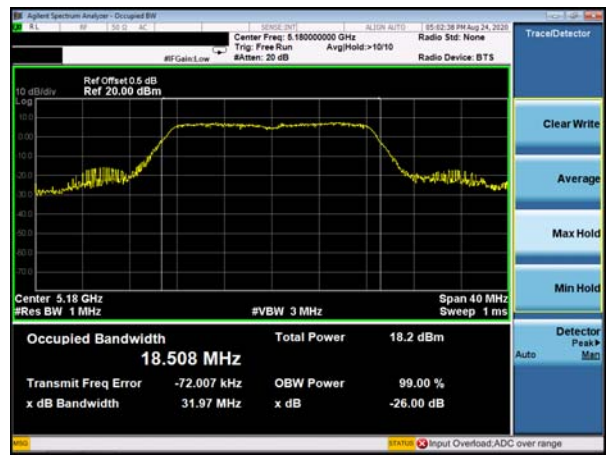

(802.11 n40) 26dB&99%Bandwidth plot on channel 46



(802.11 AC20) 26dB&99%Bandwidth plot on channel 40

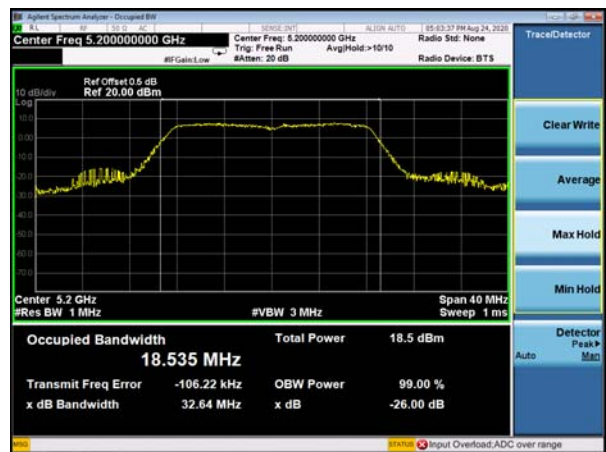

(802.11 AC20) 26dB&99%Bandwidth plot on channel 48

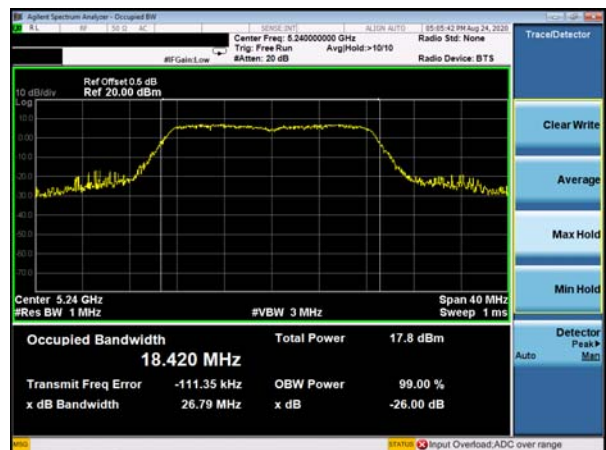

Test plot

(802.11 AC40) 26dB&99%Bandwidth plot on channel 38



(802.11 AC80) 26dB&99%Bandwidth plot on channel 42

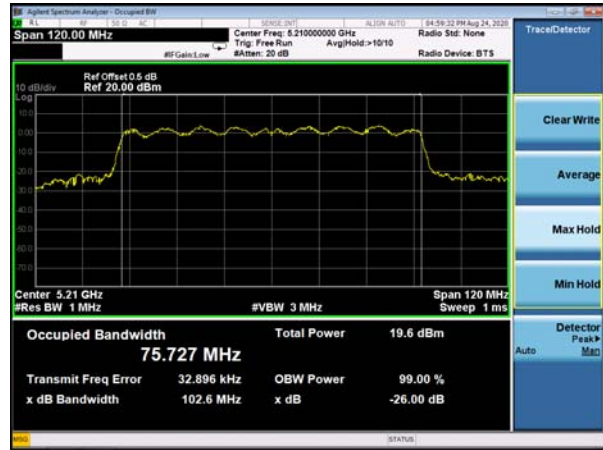

(802.11 AC40) 26dB&99%Bandwidth plot on channel 46

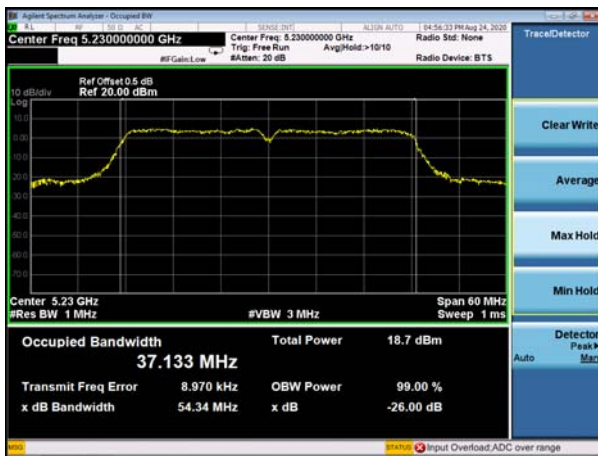

6. MAXIMUM CONDUCTED OUTPUT POWER

6.1 PPLIED PROCEDURES / LIMIT

According to FCC §15.407

The maximum conducted output power should not exceed:

Frequency Band(MHz)	Limit
5150~5250	1W

6.2 TEST PROCEDURE

· Maximum conducted output power may be measured using a spectrum analyzer/EMI receiver or an RF power meter.

1. Device Configuration

If possible, configure or modify the operation of the EUT so that it transmits continuously at its maximum power control level (see section II.B.).

a) The intent is to test at 100 percent duty cycle; however a small reduction in duty cycle (to no lower than 98 percent) is permitted if required by the EUT for amplitude control purposes. Manufacturers are expected to provide software to the test lab to permit such continuous operation.

b) If continuous transmission (or at least 98 percent duty cycle) cannot be achieved due to hardware limitations (e.g., overheating), the EUT shall be operated at its maximum power control level with the transmit duration as long as possible and the duty cycle as high as possible.

2. Measurement using a Spectrum Analyzer or EMI Receiver (SA)

Measurement of maximum conducted output power using a spectrum analyzer requires integrating the spectrum across a frequency span that encompasses, at a minimum, either the EBW or the 99-percent occupied bandwidth of the signal.¹ However, the EBW must be used to determine bandwidth dependent limits on maximum conducted output power in accordance with § 15.407(a).

a) The test method shall be selected as follows: (i) Method SA-1 or SA-1 Alternative (averaging with the EUT transmitting at full power throughout each sweep) shall be applied if either of the following conditions can be satisfied:

- The EUT transmits continuously (or with a duty cycle ≥ 98 percent).
- Sweep triggering or gating can be implemented in a way that the device transmits at the maximum power control level throughout the duration of each of the instrument sweeps to be averaged. This condition can generally be achieved by triggering the instrument's sweep if the duration of the sweep (with the analyzer configured as in Method SA-1, below) is equal to or shorter than the duration T of each transmission from the EUT and if those transmissions exhibit full power throughout their durations.

(ii) Method SA-2 or SA-2 Alternative (averaging across on and off times of the EUT transmissions, followed by duty cycle correction) shall be applied if the conditions of (i) cannot be achieved and the transmissions exhibit a constant duty cycle during the measurement duration. Duty cycle will be considered to be constant if variations are less than ± 2 percent.

(iii) Method SA-3 (RMS detection with max hold) or SA-3 Alternative (reduced VBW with max hold) shall be applied if the conditions of (i) and (ii) cannot be achieved.

b) Method SA-1 (trace averaging with the EUT transmitting at full power throughout each sweep): (i) Set span to encompass the entire emission bandwidth (EBW) (or, alternatively, the entire 99% occupied bandwidth) of the signal.

(ii) Set RBW = 1 MHz.

(iii) Set VBW ≥ 3 MHz.

(iv) Number of points in sweep ≥ 2 Span / RBW. (This ensures that bin-to-bin spacing is \leq RBW/2, so that narrowband signals are not lost between frequency bins.)

(v) Sweep time = auto.

(vi) Detector = RMS (i.e., power averaging), if available. Otherwise, use sample detector mode.

(vii) If transmit duty cycle < 98 percent, use a video trigger with the trigger level set to enable triggering only on full power pulses. Transmitter must operate at maximum power control level for the entire duration of every sweep. If the EUT transmits continuously (i.e., with no off intervals) or at duty cycle ≥ 98 percent, and if each transmission is entirely at the maximum power control level, then the trigger shall be set to "free run".

(viii) Trace average at least 100 traces in power averaging (i.e., RMS) mode.

(ix) Compute power by integrating the spectrum across the EBW (or, alternatively, the entire 99% occupied bandwidth) of the signal using the instrument's band power measurement function with band limits set equal to the EBW (or occupied bandwidth) band edges. If the instrument does not have a band power function, sum the spectrum

6.3 DEVIATION FROM STANDARD

No deviation.

6.4 TEST SETUP



6.5 EUT OPERATION CONDITIONS

The EUT tested system was configured as the statements of 2.4 Unless otherwise a special operating condition is specified in the follows during the testing.

6.6 TEST RESULTS

Temperature :	26 °C	Relative Humidity :	54%
Pressure :	101kPa	Test Voltage :	AC 120V/60Hz
Test Mode :	TX (5.1G) Mode Frequency U-NII-1 (5180-5240MHz)		

Test Channel	Frequency	Maximum output power. Antenna port (AV)			LIMIT	Result
	(MHz)	ANT A(dBm)	ANT B(dBm)	Total(dBm)	dBm	
TX 802.11a Mode						
CH36	5180	14.407	14.388	/	30	Pass
CH40	5200	14.441	14.748	/	30	Pass
CH48	5240	14.142	14.450	/	30	Pass
TX 802.11 n20M Mode						
CH36	5180	13.311	13.366	16.349	30	Pass
CH40	5200	13.439	13.498	16.479	30	Pass
CH48	5240	13.504	13.471	16.498	30	Pass
TX 802.11 n40M Mode						
CH38	5190	11.831	11.878	14.865	30	Pass
CH46	5230	11.223	11.908	14.589	30	Pass
TX 802.11 AC20M Mode						
CH36	5180	13.406	13.456	16.441	30	Pass
CH40	5200	13.193	13.469	16.343	30	Pass
CH48	5240	13.288	13.212	16.260	30	Pass
TX 802.11 AC40M Mode						
CH38	5190	11.504	11.574	14.549	30	Pass
CH46	5230	11.258	11.449	14.365	30	Pass
TX 802.11 AC80M Mode						
CH42	5210	10.080	9.676	12.893	30	Pass

7. OUT OF BAND EMISSIONS

7.1 APPLICABLE STANDARD

According to FCC §15.407(b)

Undesirable emission limits. Except as shown in paragraph (b)(7) of this section, the maximum emissions outside of the frequency bands of operation shall be attenuated in accordance with the following limits:

(1) For transmitters operating in the 5.15-5.25 GHz band: All emissions outside of the 5.15-5.35 GHz band shall not exceed an e.i.r.p. of -27 dBm/MHz.

(2) All emissions shall be limited to a level of -27 dBm/MHz at 75 MHz or more above or below the band edge increasing linearly to 10 dBm/MHz at 25 MHz above or below the band edge, and from 25 MHz above or below the band edge increasing linearly to a level of 15.6 dBm/MHz at 5 MHz above or below the band edge, and from 5 MHz above or below the band edge increasing linearly to a level of 27 dBm/MHz at the band edge.

7.2 TEST PROCEDURE

1. Check the calibration of the measuring instrument using either an internal calibrator or a known signal from an external generator.
2. Position the EUT without connection to measurement instrument. Turn on the EUT and connect its antenna terminal to measurement instrument via a low loss cable. Then set it to any one measured frequency within its operating range, and make sure the instrument is operated in its linear range.
3. Set RBW of spectrum analyzer to 1 MHz with a convenient frequency span.
4. Measure the highest amplitude appearing on spectral display and set it as a reference level. Plot the graph with marking the highest point and edge frequency.
5. Repeat above procedures until all measured frequencies were complete.

7.3 DEVIATION FROM STANDARD

No deviation.

7.4 TEST SETUP

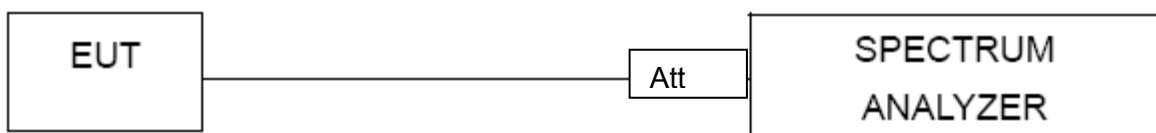

7.5 EUT OPERATION CONDITIONS

The EUT tested system was configured as the statements of 2.4 Unless otherwise a special operating condition is specified in the follows during the testing.

7.6 TEST RESULTS

Temperature :	26 °C	Relative Humidity :	54%
Pressure :	101kPa	Test Voltage :	AC 120V/60Hz

Note: A(B) Represent the value of antenna A and B, The worst data is Antenna B ,only shown Antenna B . Plot.Antenna B: 5180-5240MHz

5.1G
5.180~5.240 GHz

(802.11a) Band Edge, Left Side

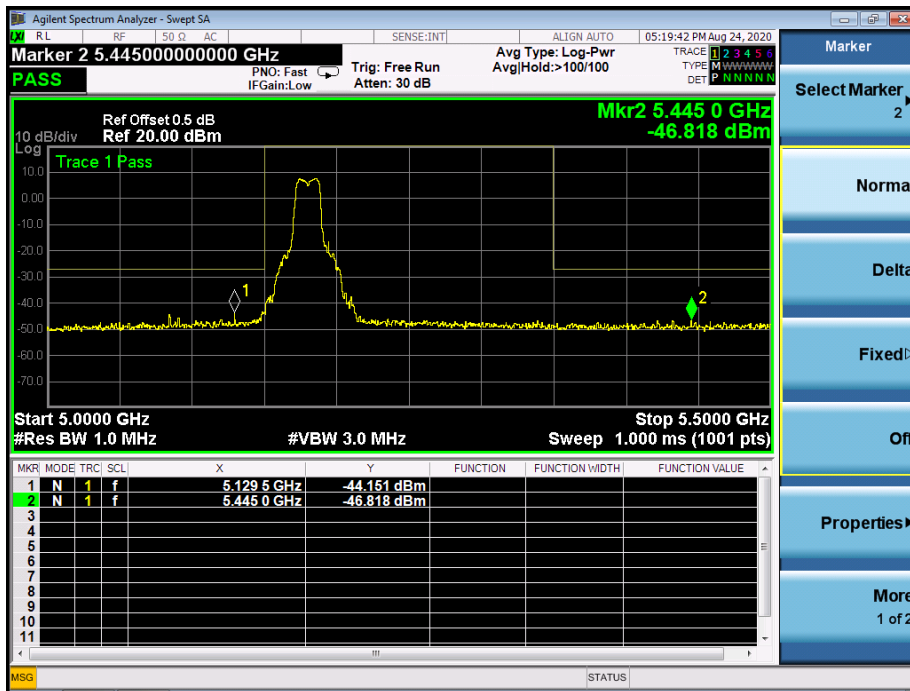

(802.11a) Band Edge, Right Side

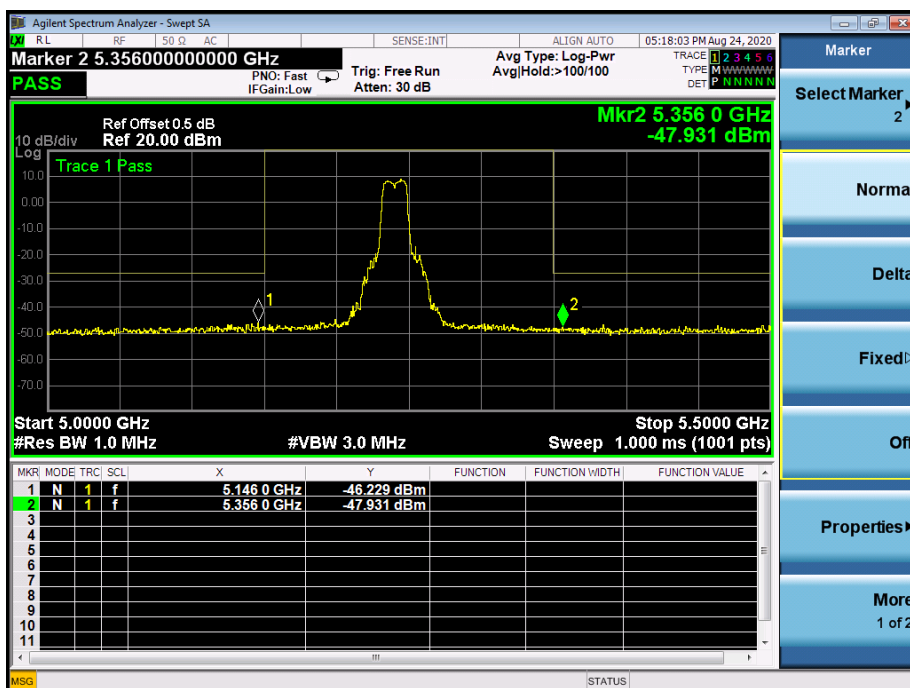

(802.11n20) Band Edge, Left Side

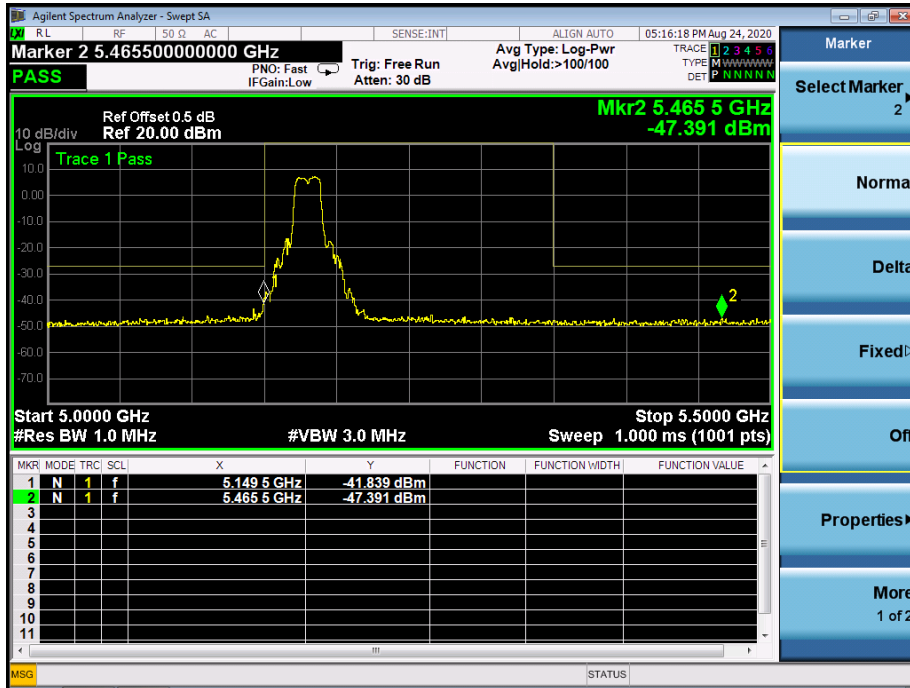

(802.11n20) Band Edge, Right Side

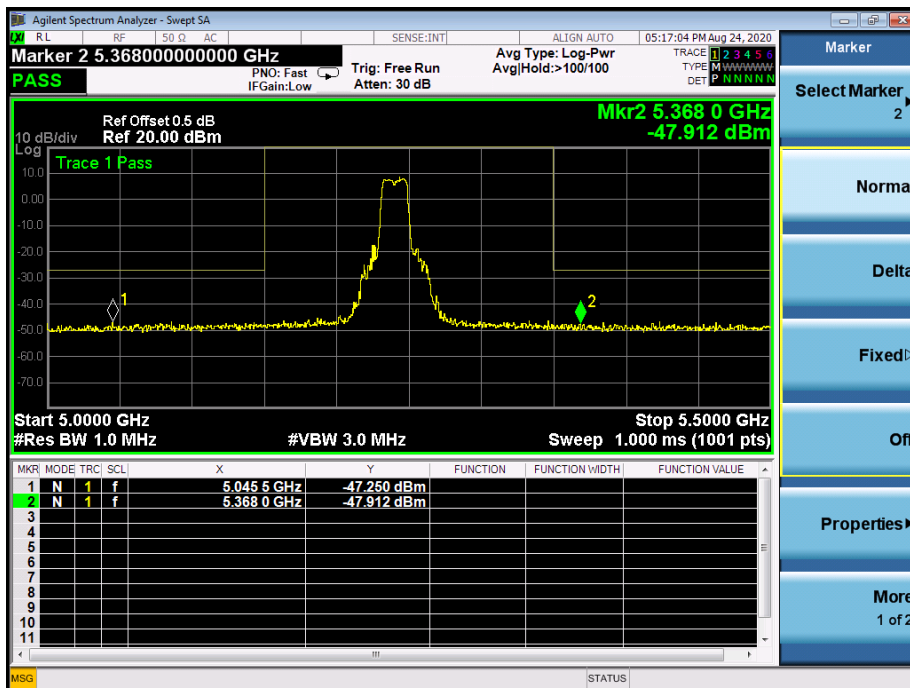

(802.11n40) Band Edge, Left Side

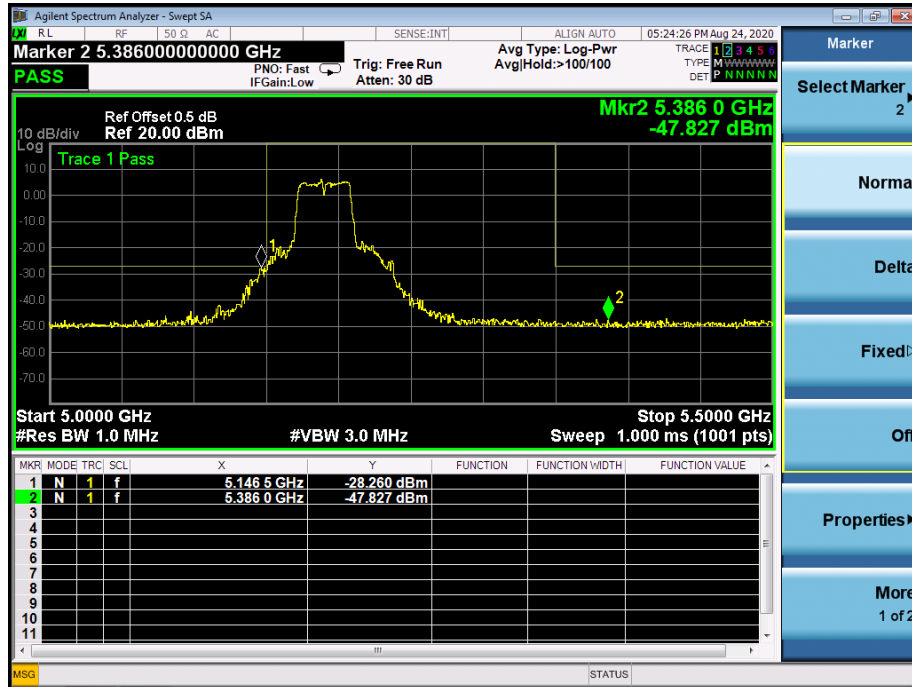

(802.11n40) Band Edge, Right Side

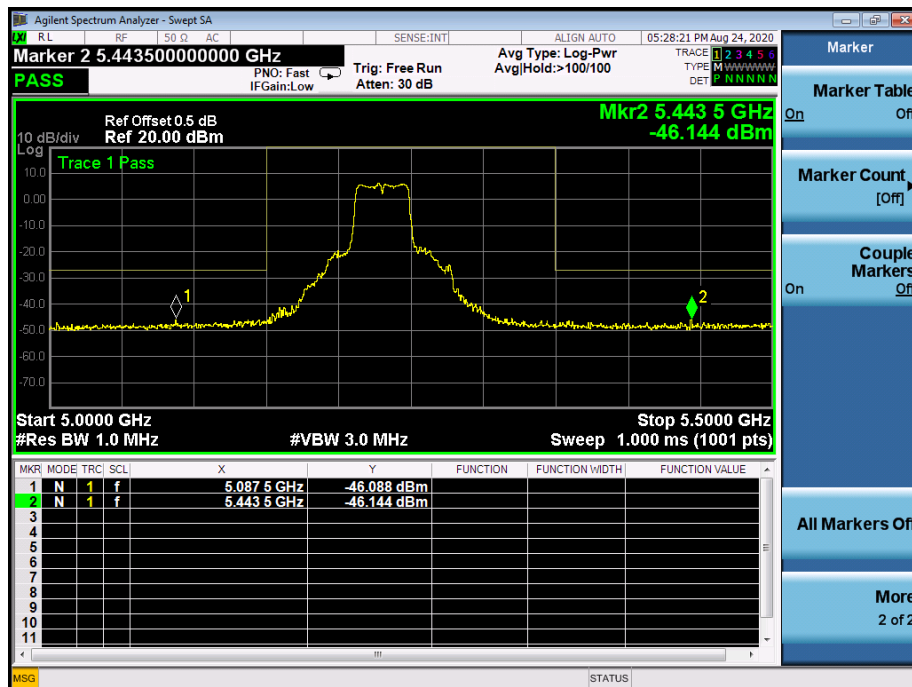

(802.11ac20) Band Edge, Left Side

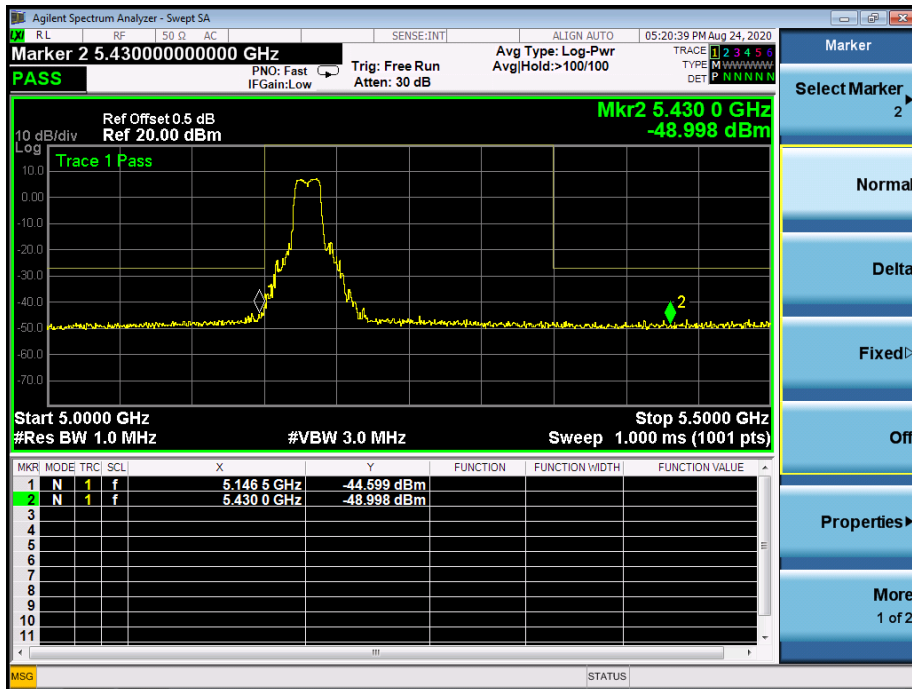

(802.11ac20) Band Edge, Right Side

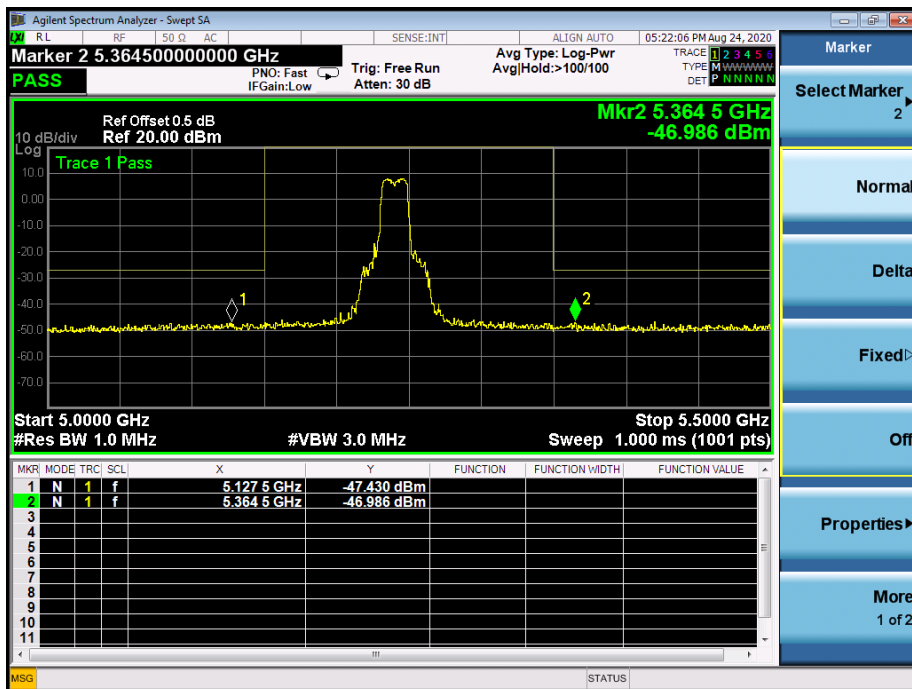

(802.11ac40) Band Edge, Left Side

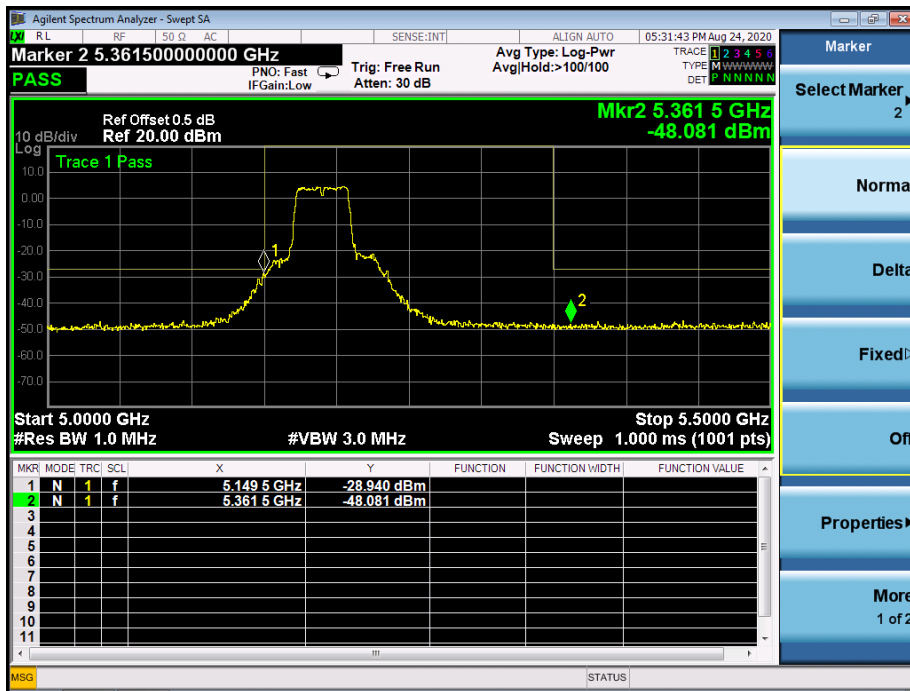

(802.11ac40) Band Edge, Right Side

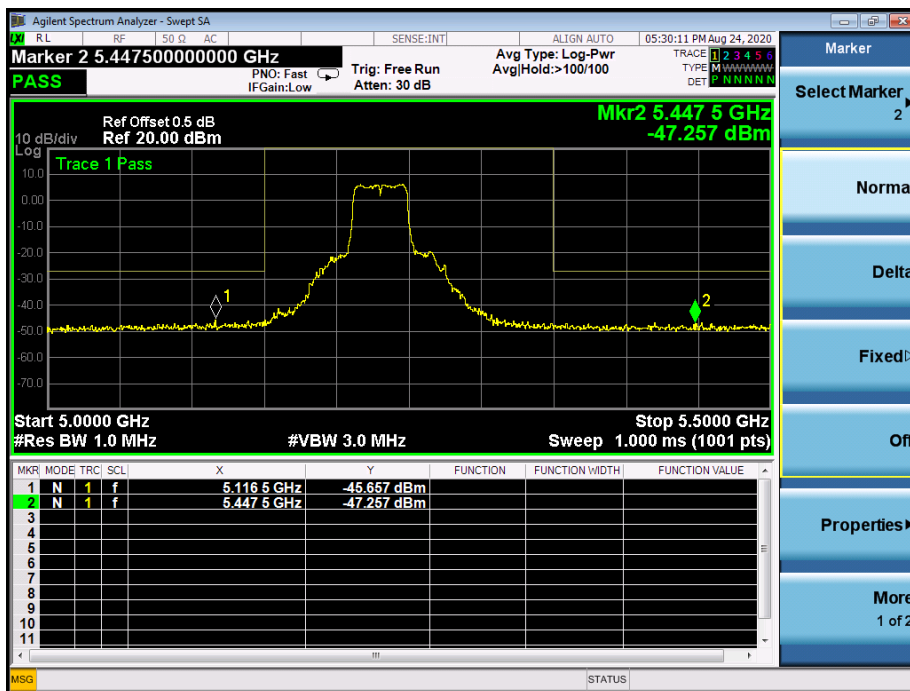

(802.11ac80) Band Edge, Left Side

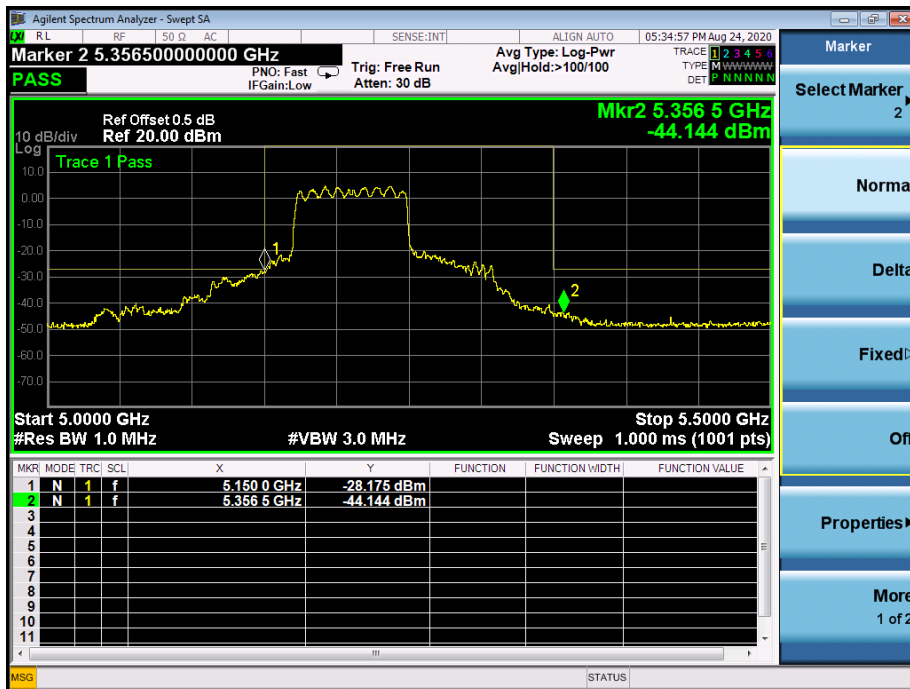

(802.11ac80) Band Edge, Right Side



Radiated bandedge

Temperature :	26 °C	Relative Humidity :	54%
Pressure :	101 kPa	Polarization :	Horizontal
Test Voltage :	AC 120V/60Hz	Remark:	N/A

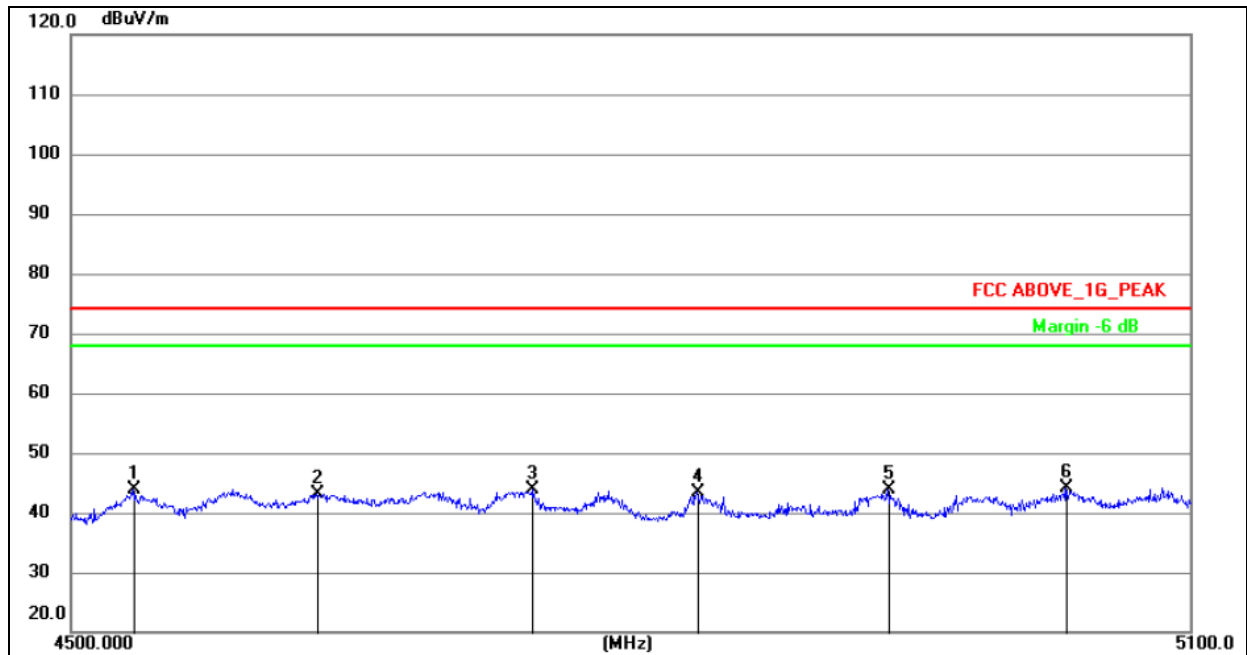

Remark:

Factor = Antenna Factor + Cable Loss – Pre-amplifier.

No.	Mk.	Freq.	Reading Level	Correct Factor	Measurement	Limit	Over	Detector
		MHz		dB			dB	
1		4531.200	44.49	-0.63	43.86	74.00	-30.14	peak
2		4625.400	43.62	-0.56	43.06	74.00	-30.94	peak
3		4738.200	44.25	-0.48	43.77	74.00	-30.23	peak
4		4826.400	43.86	-0.41	43.45	74.00	-30.55	peak
5		4930.800	44.17	-0.34	43.83	74.00	-30.17	peak
6	*	5029.800	44.27	-0.16	44.11	74.00	-29.89	peak

Temperature :	26 °C	Relative Humidity :	54%
Pressure :	101 kPa	Polarization :	Vertical
Test Voltage :	AC 120V/60Hz	Remark:	N/A

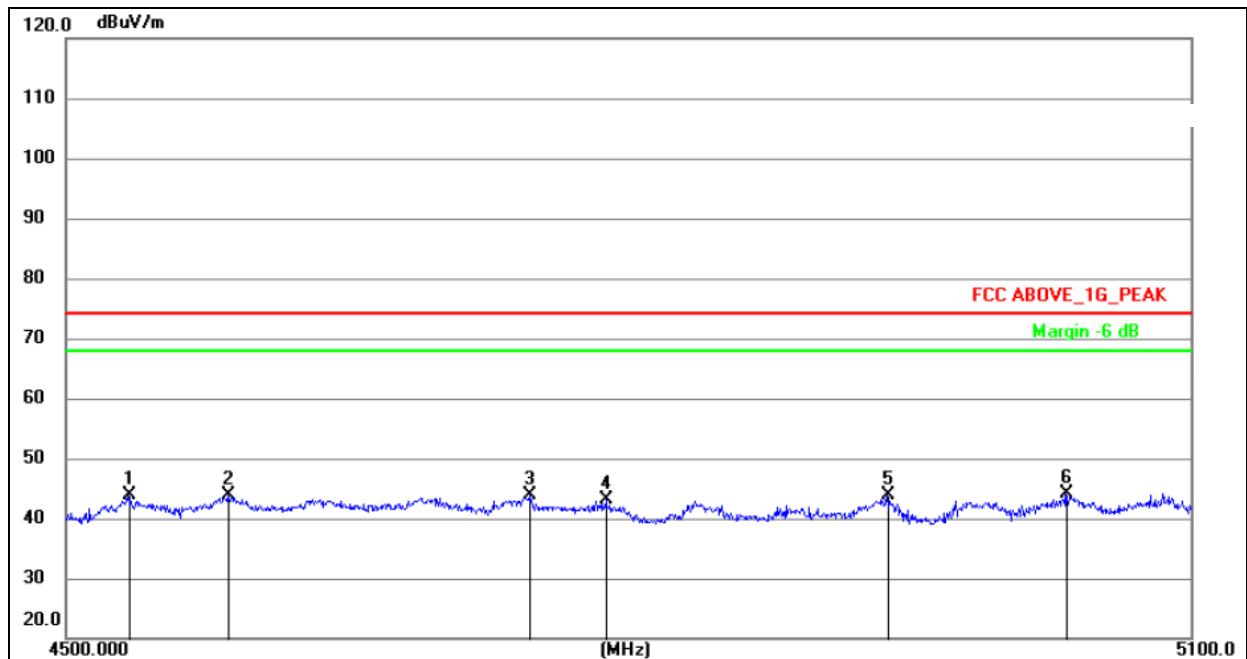

Remark:

Factor = Antenna Factor + Cable Loss – Pre-amplifier.

No.	Mk.	Freq.	Reading Level	Correct Factor	Measurement	Limit	Over	
		MHz		dB			dB	Detector
1		4531.200	44.49	-0.63	43.86	74.00	-30.14	peak
2		4582.200	44.44	-0.59	43.85	74.00	-30.15	peak
3		4738.200	44.25	-0.48	43.77	74.00	-30.23	peak
4		4779.000	43.46	-0.45	43.01	74.00	-30.99	peak
5		4930.800	44.17	-0.34	43.83	74.00	-30.17	peak
6	*	5029.800	44.27	-0.16	44.11	74.00	-29.89	peak

Note:

1. This EUT was tested in 802.11a/n(HT20),n(HT40),ac(HT20), ac(HT40), ac(HT80) mode and 802.11a Antenna A the worst case position data was reported.

Temperature :	26 °C	Relative Humidity :	54%
Pressure :	101 kPa	Polarization :	Horizontal
Test Voltage :	AC 120V/60Hz	Remark:	N/A

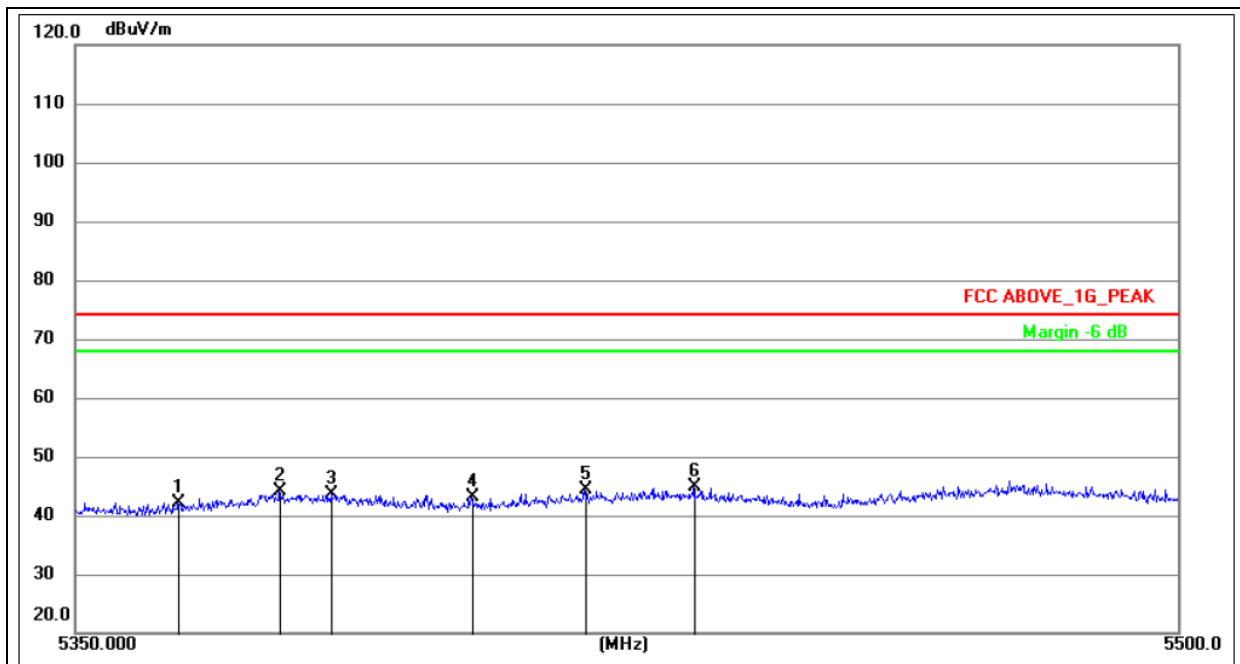

Remark:
 Factor = Antenna Factor + Cable Loss – Pre-amplifier.

No.	Frequency (MHz)	Reading (dBuV)	Correct (dB/m)	Result (dBuV/m)	Limit (dBuV/m)	Margin (dB)	Remark
1	5363.800	40.99	1.26	42.25	74.00	-31.75	peak
2	5377.450	42.82	1.31	44.13	74.00	-29.87	peak
3	5384.500	42.22	1.34	43.56	74.00	-30.44	peak
4	5403.400	41.74	1.42	43.16	74.00	-30.84	peak
5	5418.850	42.94	1.49	44.43	74.00	-29.57	peak
6	5433.700	43.26	1.55	44.81	74.00	-29.19	peak

Temperature :	26 °C	Relative Humidity :	54%
Pressure :	101 kPa	Polarization :	Vertical
Test Voltage :	AC 120V/60Hz	Remark:	N/A

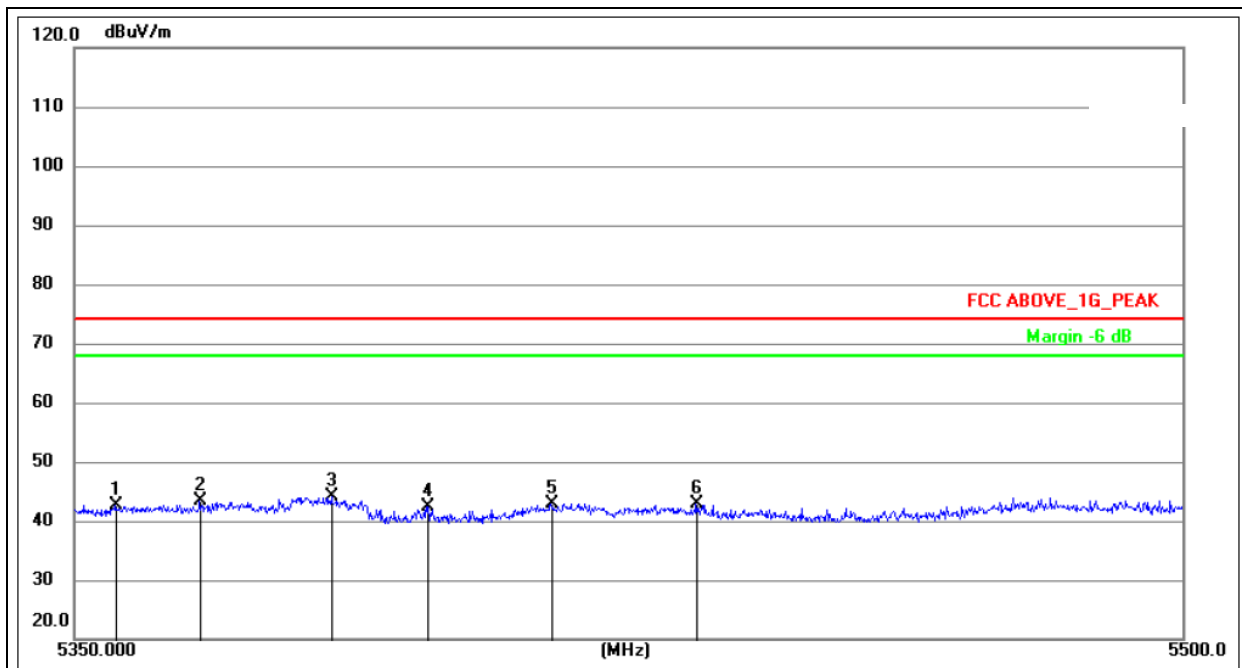

Remark:

Factor = Antenna Factor + Cable Loss – Pre-amplifier.

No.	Frequency (MHz)	Reading (dBuV)	Correct (dB/m)	Result (dBuV/m)	Limit (dBuV/m)	Margin (dB)	Remark
1	5355.550	41.43	1.22	42.65	74.00	-31.35	peak
2	5366.800	42.01	1.27	43.28	74.00	-30.72	peak
3	5384.500	42.72	1.34	44.06	74.00	-29.94	peak
4	5397.400	40.88	1.40	42.28	74.00	-31.72	peak
5	5414.050	41.52	1.47	42.99	74.00	-31.01	peak
6	5433.700	41.26	1.55	42.81	74.00	-31.19	peak

Note:

1. This EUT was tested in 802.11a/n(HT20),n(HT40),ac(HT20), ac(HT40), ac(HT80) mode and 802.11a Antenna A the worst case position data was reported.

8.SPURIOUS RF CONDUCTED EMISSIONS

8.1 CONFORMANCE LIMIT

Undesirable emission limits. Except as shown in paragraph (b)(7) of this section, the maximum emissions outside of the frequency bands of operation shall be attenuated in accordance with the following limits:

- (1) For transmitters operating in the 5.15-5.25 GHz band: All emissions outside of the 5.15-5.35 GHz band shall not exceed an e.i.r.p. of -27 dBm/MHz.
- (2) For transmitters operating in the 5.725-5.85 GHz band(i) All emissions shall be limited to a level of -27 dBm/MHz at 75 MHz or more above or below the band edge increasing linearly to 10 dBm/MHz at 25 MHz above or below the band edge, and from 25 MHz above or below the band edge increasing linearly to a level of 15.6 dBm/MHz at 5 MHz above or below the band edge, and from 5 MHz above or below the band edge increasing linearly to a level of 27 dBm/MHz at the band edge.

8.2 MEASURING INSTRUMENTS

The Measuring equipment is listed in the section 6.3 of this test report.

8.3 TEST SETUP

Please refer to Section 6.1 of this test report.

8.4 TEST PROCEDURE

1. Check the calibration of the measuring instrument using either an internal calibrator or a known signal from an external generator.
2. Position the EUT without connection to measurement instrument. Turn on the EUT and connect its antenna terminal to measurement instrument via a low loss cable. Then set it to any one measured frequency within its operating range, and make sure the instrument is operated in its linear range.
3. Set RBW of spectrum analyzer to 1 MHz with a convenient frequency span.
4. Measure the highest amplitude appearing on spectral display and set it as a reference level. Plot the graph with marking the highest point and edge frequency.
5. Repeat above procedures until all measured frequencies were complete.

8.5 TEST RESULTS

Remark: The measurement frequency range is from 9KHz to the 10th harmonic of the fundamental frequency. The lowest, middle and highest channels are tested to verify the spurious emissions and bandedge measurement data.

About:26.5GHz-40GHz, The amplitude of spurious emissions which are attenuated by more than 20dB below the permissible value has no need to be reported.

Note: A(B) Represent the value of antenna A and B, The worst data is Antenna B ,only shown Antenna B Plot.

5.1G
Test Plot

802.11a on channel 36

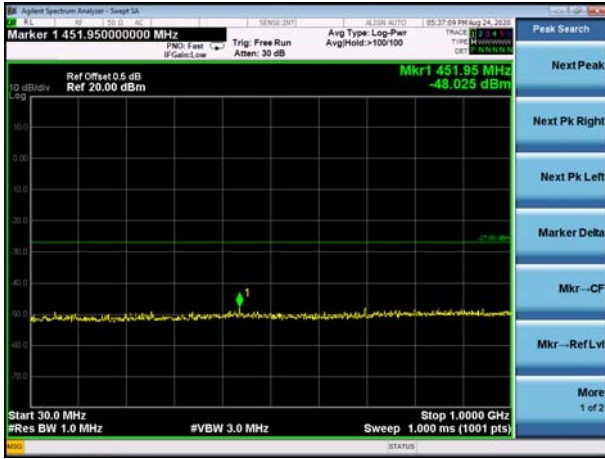

802.11a on channel 40

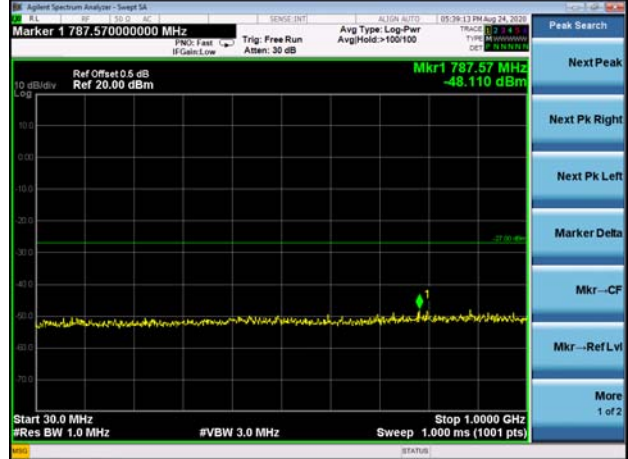

802.11a on channel 36

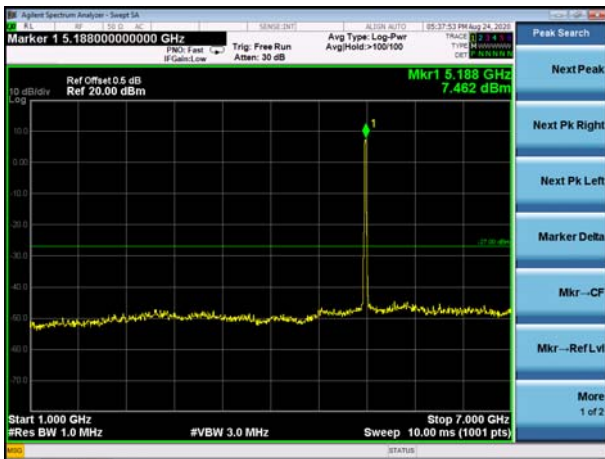

802.11a on channel 40

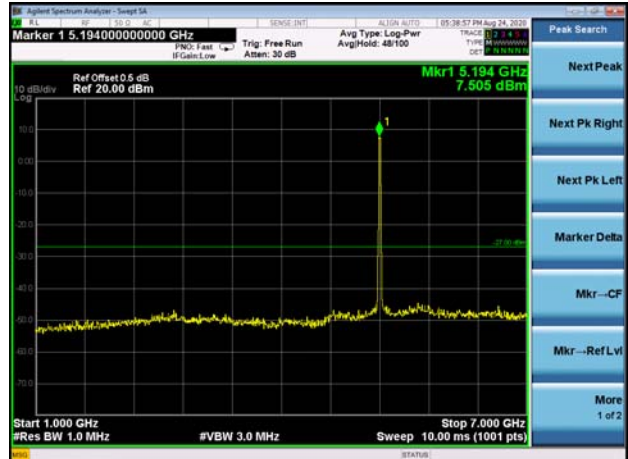

802.11a on channel 36



802.11a on channel 40



Test Plot

802.11a on channel 48

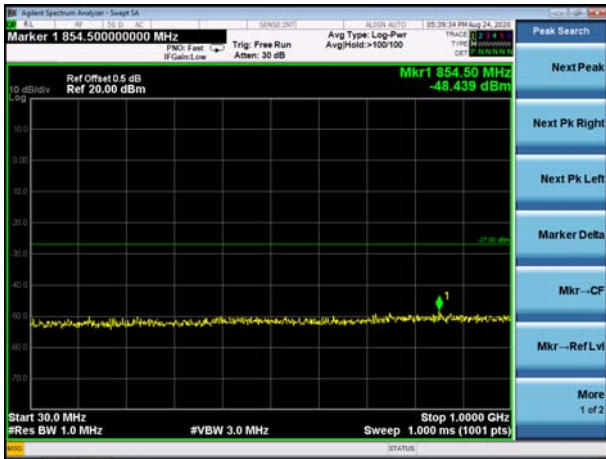

802.11n20 on channel 36

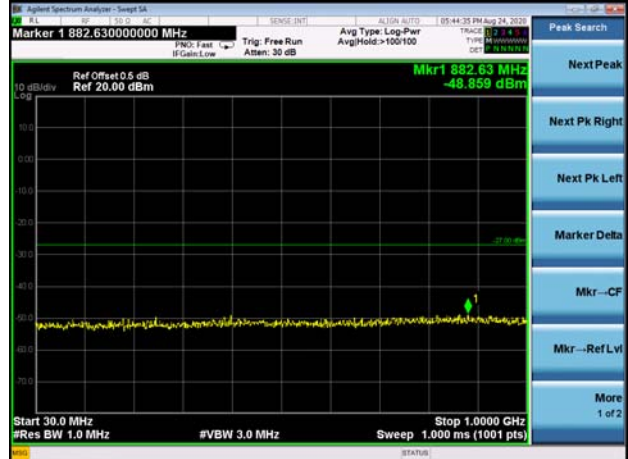

802.11a on channel 48

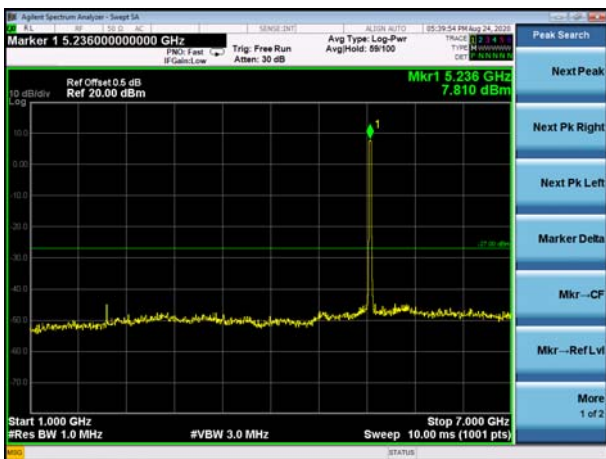

802.11n20 on channel 36



802.11a on channel 48



802.11n20 on channel 36



Test Plot

802.11n20 on channel 40

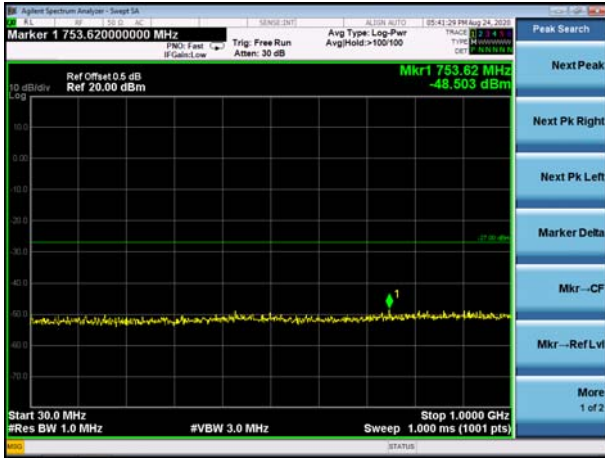

802.11n20 on channel 48

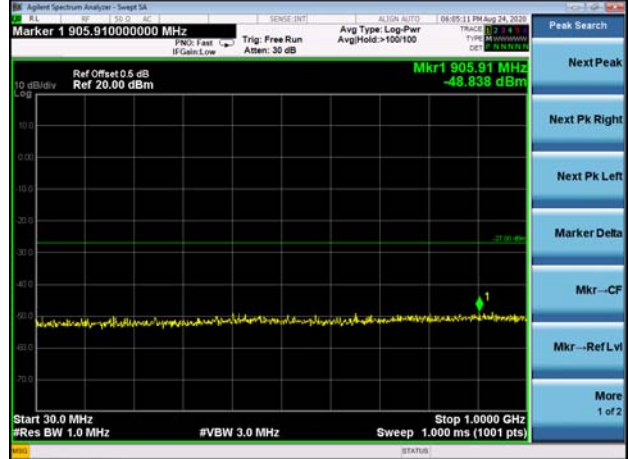

802.11n20 on channel 40

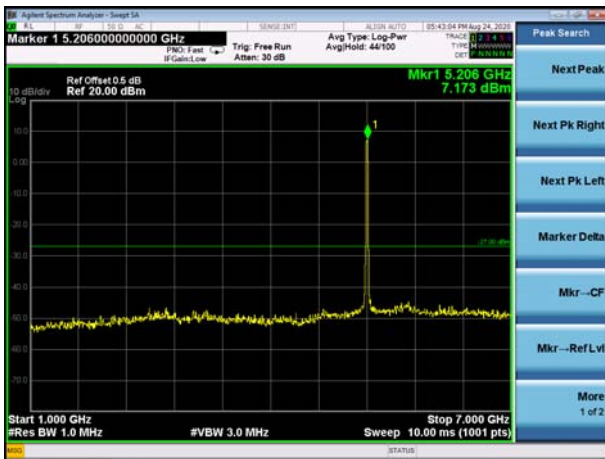

802.11n20 on channel 48

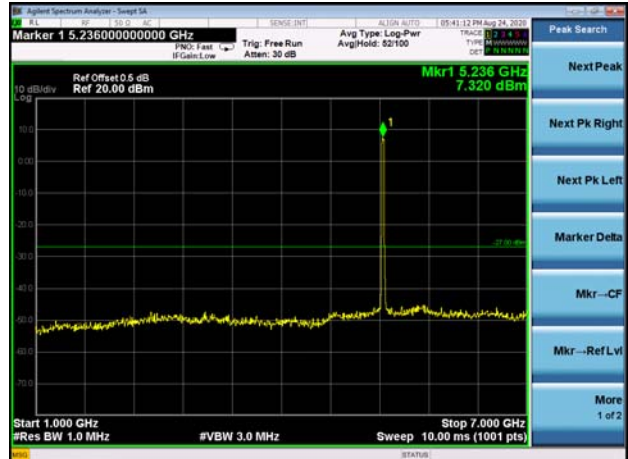

802.11n20 on channel 40



802.11n20 on channel 48



Test Plot

802.11n40 on channel 38

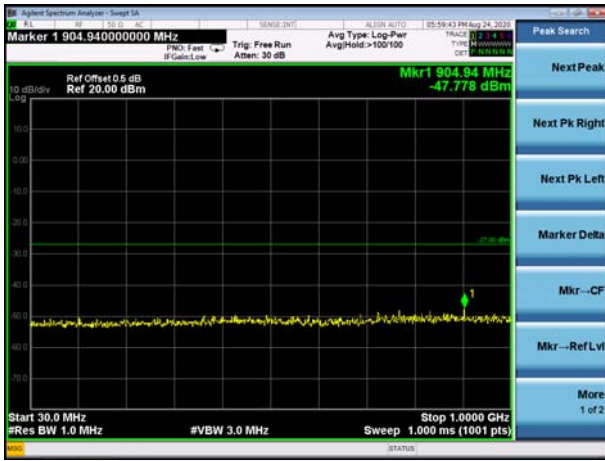

802.11n40 on channel 46

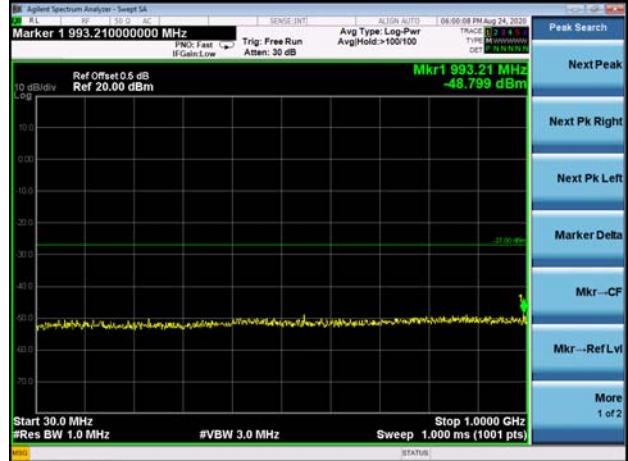

802.11n40 on channel 38

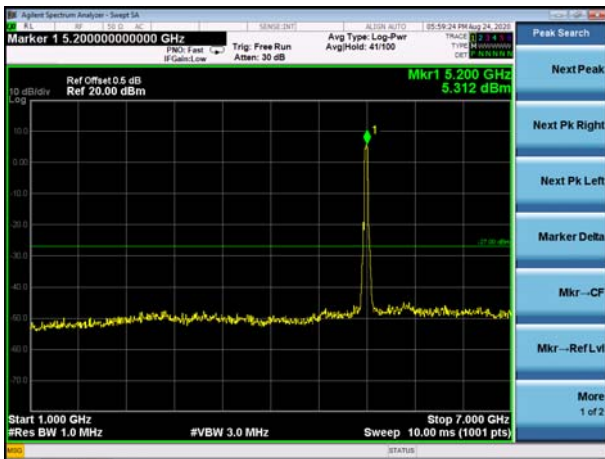

802.11n40 on channel 46

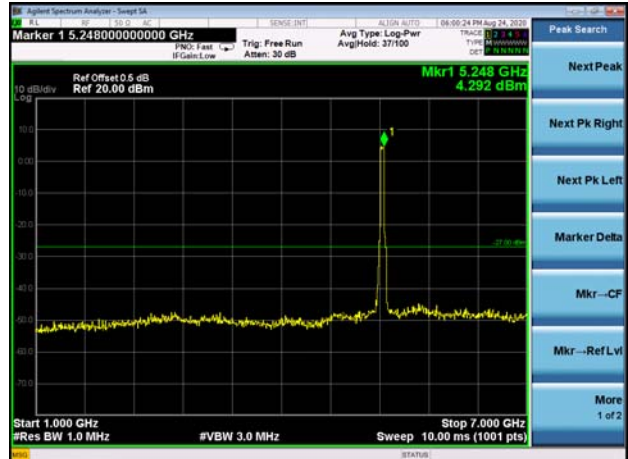

802.11n40 on channel 38



802.11n40 on channel 46



Test Plot

802.11ac20 on channel 36

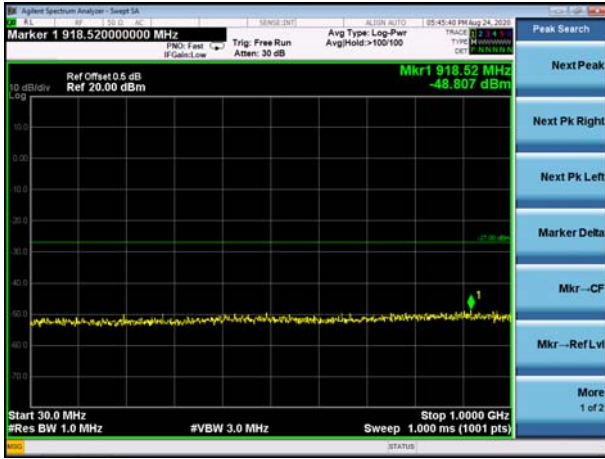

802.11ac20 on channel 40

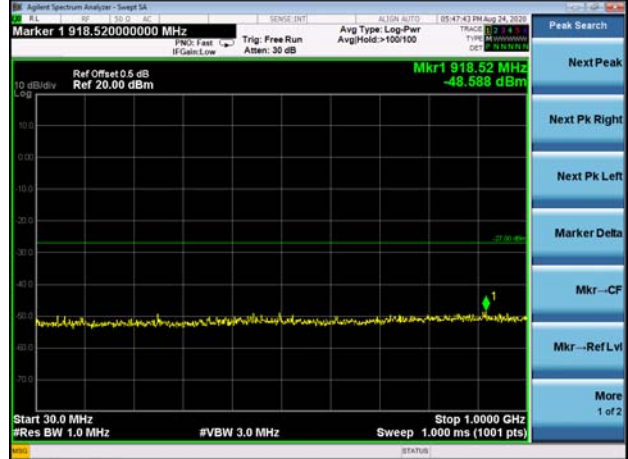

802.11ac20 on channel 36

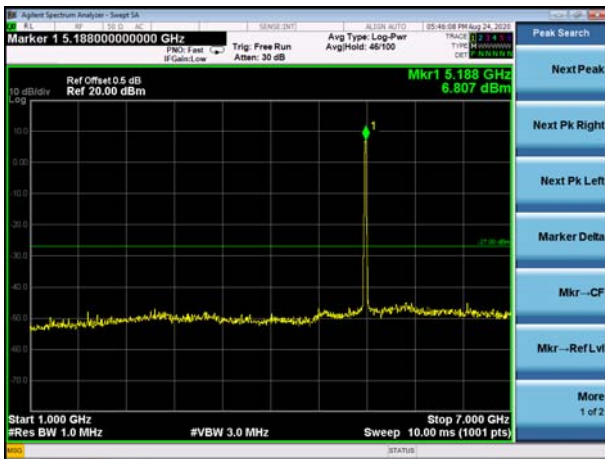

802.11ac20 on channel 40

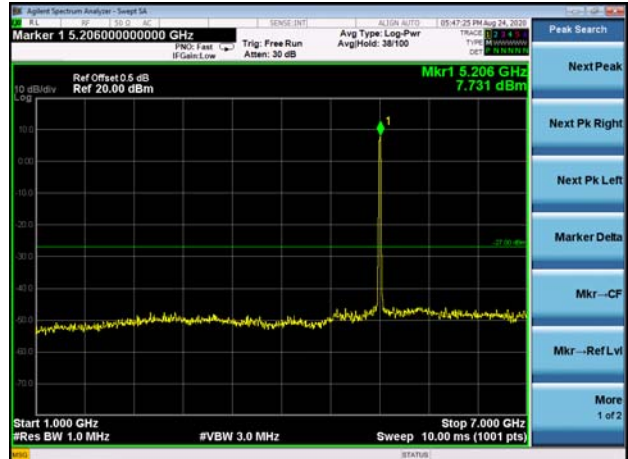

802.11ac20 on channel 36



802.11ac20 on channel 40



Test Plot

802.11ac20 on channel 48

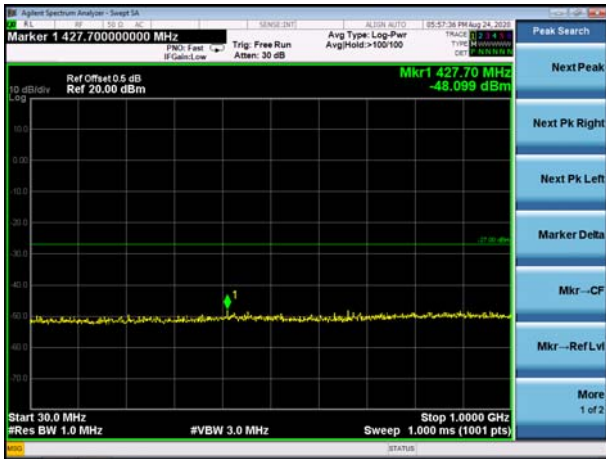

802.11ac40 on channel 38

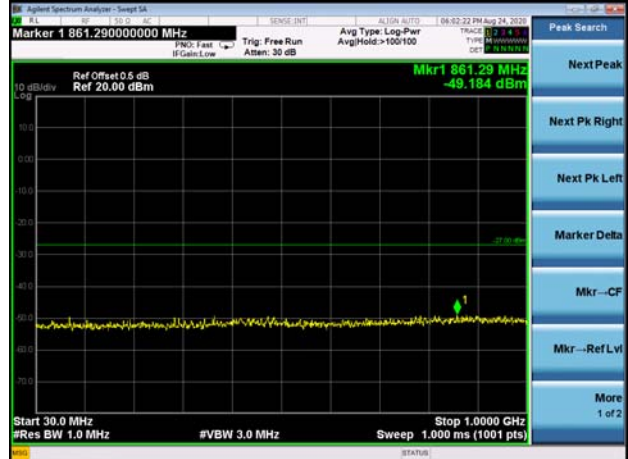

802.11ac20 on channel 48

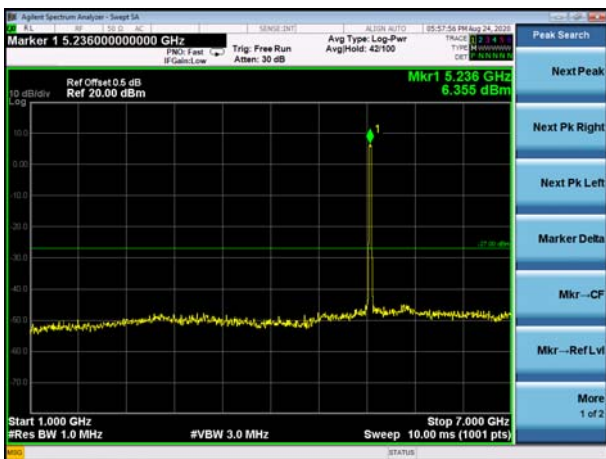

802.11ac40 on channel 38

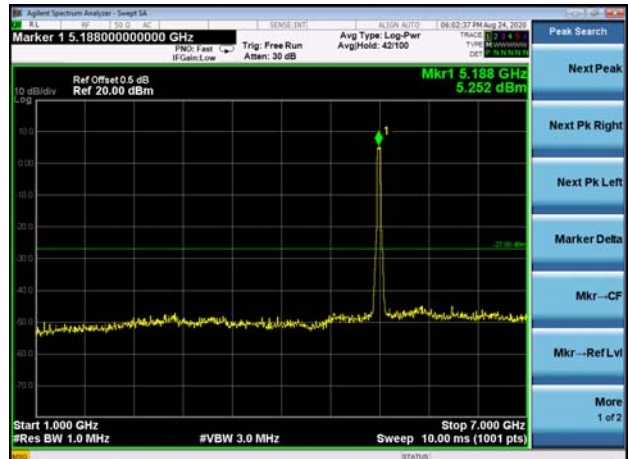

802.11ac20 on channel 48



802.11ac40 on channel 38



Test Plot

802.11ac40 on channel 46

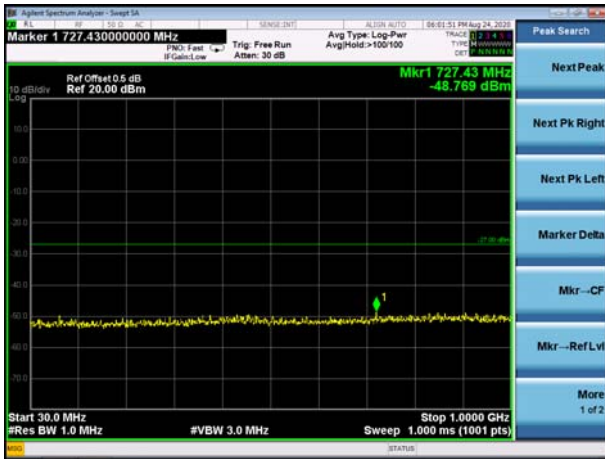

802.11ac80 on channel 42

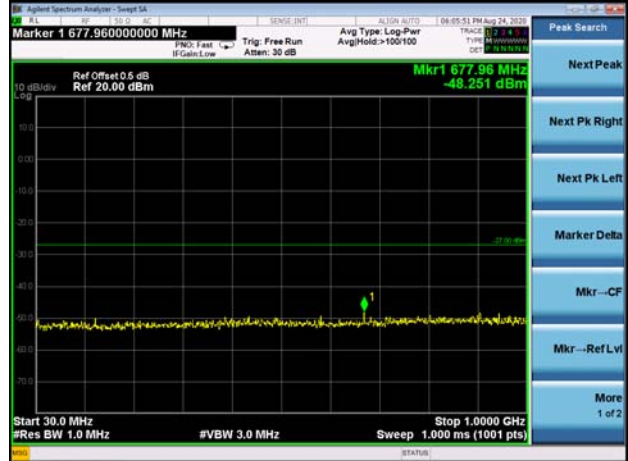

802.11 ac40 on channel 46

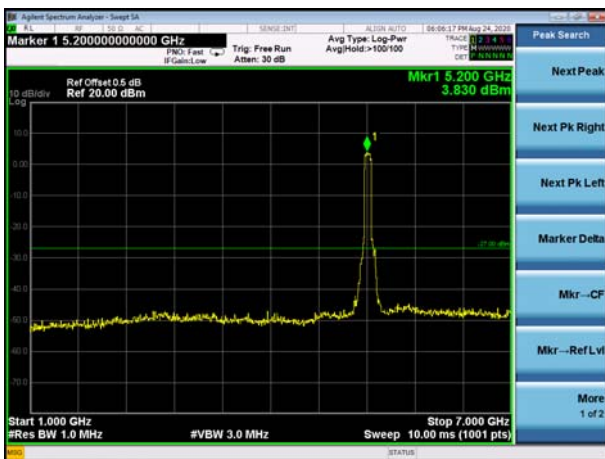

802.11 ac80 on channel 42

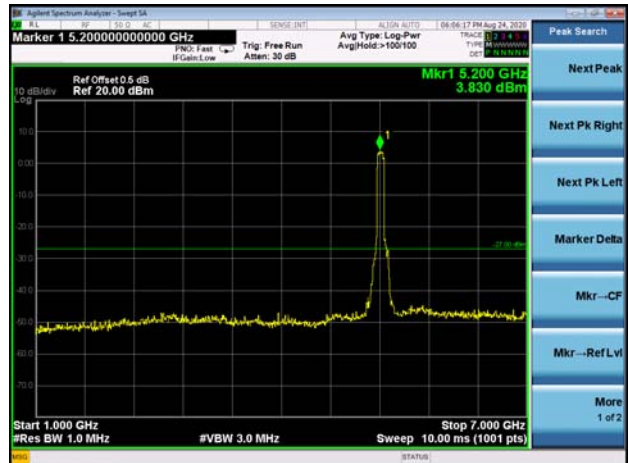

802.11 ac40 on channel 46



802.11 ac80 on channel 42



9. Frequency Stability Measurement

9.1 LIMIT

Manufactures of U-NII devices are responsible for ensuring frequency stability such that an emission is maintained within the band of operation under all conditions of normal operation as specified in the user's manual.

The transmitter center frequency tolerance shall be ± 20 ppm maximum for the 5 GHz band (IEEE 802.11n specification).

9.2 TEST PROCEDURES

1. The transmitter output (antenna port) was connected to the spectrum analyzer.
2. EUT have transmitted absence of modulation signal and fixed channelize.
3. Set the spectrum analyzer span to view the entire absence of modulation emissions bandwidth.
4. Set RBW = 10 kHz, VBW = 10 kHz with peak detector and maxhold settings.
5. f_c is declaring of channel frequency. Then the frequency error formula is $(f_c - f) / f_c \times 10^6$ ppm and the limit is less than ± 20 ppm (IEEE 802.11n specification).
6. The test extreme voltage is to change the primary supply voltage from 85 to 115 percent of the nominal value
7. Extreme temperature is $-20^{\circ}\text{C} \sim 70^{\circ}\text{C}$.

9.3 TEST SETUP LAYOUT

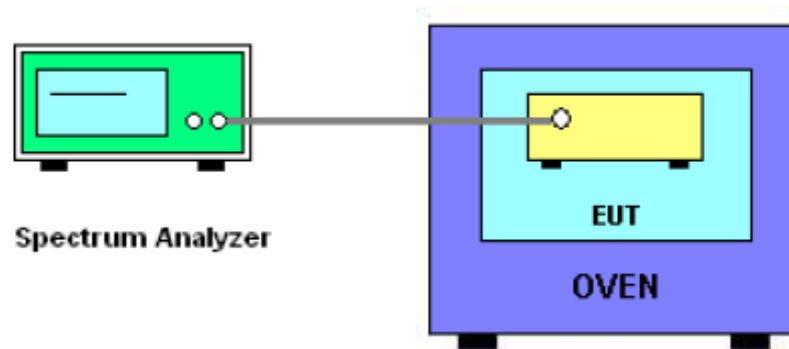

9.4 EUT OPERATION DURING TEST

The EUT was programmed to be in continuously un-modulation transmitting mode.

9.5 TEST RESULTS

Temperature :	26 °C	Relative Humidity :	54%
Pressure :	101kPa	Test Voltage :	AC 120V/60Hz
Test Mode :	TX Frequency U-NII-1 (5180-5240MHz)		

Voltage vs. Frequency Stability

TEST CONDITIONS				Reference Frequency: 5180MHz			
				f	fc	Max. Deviation (MHz)	Max. Deviation (ppm)
T nom (°C)	20	V nom (V)	120.00	5180.0526	5180	0.0526	10.1544
		V max (V)	138.00	5180.0324	5180	0.0324	6.2548
		V min (V)	102.00	5180.0243	5180	0.0243	4.6911
Limits				5150-5250 MHz			
Result				Complies			

Temperature vs. Frequency Stability

TEST CONDITIONS				Reference Frequency: 5180MHz			
				f	fc	Max. Deviation (MHz)	Max. Deviation (ppm)
V nom (V)	AC120	T (°C)	-20	5180.0053	5180	0.0053	1.0232
		T (°C)	-10	5180.0106	5180	0.0106	2.0463
		T (°C)	0	5180.0327	5180	0.0327	6.3127
		T (°C)	10	5180.0386	5180	0.0386	7.4517
		T (°C)	20	5180.0295	5180	0.0295	5.6950
		T (°C)	30	5180.0217	5180	0.0217	4.1892
		T (°C)	40	5180.0129	5180	0.0129	2.4903
		T (°C)	50	5180.0094	5180	0.0094	1.8147
		T (°C)	60	5180.0415	5180	0.0415	8.0116
		T (°C)	70	5180.0697	5180	0.0697	13.4556
Limits				5150-5250 MHz			
Result				Complies			

Voltage vs. Frequency Stability

TEST CONDITIONS				Reference Frequency: 5200MHz			
				f	fc	Max. Deviation (MHz)	Max. Deviation (ppm)
T nom (°C)	20	V nom (V)	120.00	5200.0261	5200	0.0261	5.0192
		V max (V)	138.00	5200.0451	5200	0.0451	8.6731
		V min (V)	102.00	5200.0675	5200	0.0675	12.9808
Limits				5150-5250 MHz			
Result				Complies			

Temperature vs. Frequency Stability

TEST CONDITIONS				Reference Frequency: 5200MHz			
				f	fc	Max. Deviation (MHz)	Max. Deviation (ppm)
V nom (V)	AC120	T (°C)	-20	5200.0653	5200	0.0653	12.5577
		T (°C)	-10	5200.0552	5200	0.0552	10.6154
		T (°C)	0	5200.0453	5200	0.0453	8.7115
		T (°C)	10	5200.0972	5200	0.0972	18.6923
		T (°C)	20	5200.0662	5200	0.0662	12.7308
		T (°C)	30	5200.0142	5200	0.0142	2.7308
		T (°C)	40	5200.0723	5200	0.0723	13.9038
		T (°C)	50	5200.0462	5200	0.0462	8.8846
		T (°C)	60	5200.0329	5200	0.0329	6.3269
		T (°C)	70	5200.0453	5200	0.0453	8.7115
Limits				5150-5250 MHz			
Result				Complies			

Voltage vs. Frequency Stability

TEST CONDITIONS				Reference Frequency: 5240MHz			
				f	fc	Max. Deviation (MHz)	Max. Deviation (ppm)
T nom (°C)	20	V nom (V)	120.00	5240.0153	5240	0.0153	2.9198
		V max (V)	138.00	5240.0441	5240	0.0441	8.4160
		V min (V)	102.00	5240.0095	5240	0.0095	1.8130
Limits				5150-5250 MHz			
Result				Complies			

Temperature vs. Frequency Stability

TEST CONDITIONS				Reference Frequency: 5240MHz			
				f	fc	Max. Deviation (MHz)	Max. Deviation (ppm)
V nom (V)	AC120	T (°C)	-20	5240.0095	5240	0.0095	1.8130
		T (°C)	-10	5240.0039	5240	0.0039	0.7443
		T (°C)	0	5240.0146	5240	0.0146	2.7863
		T (°C)	10	5240.0856	5240	0.0856	16.3359
		T (°C)	20	5240.0118	5240	0.0118	2.2519
		T (°C)	30	5240.0126	5240	0.0126	2.4046
		T (°C)	40	5240.0068	5240	0.0068	1.2977
		T (°C)	50	5240.0075	5240	0.0075	1.4313
		T (°C)	60	5240.0056	5240	0.0056	1.0687
		T (°C)	70	5240.0105	5240	0.0105	2.0038
Limits				5150-5250 MHz			
Result				Complies			

10. ANTENNA REQUIREMENT

10.1 STANDARD REQUIREMENT

15.203 requirement: For intentional device, according to 15.203: an intentional radiator shall be designed to ensure that no antenna other than that furnished by the responsible party shall be used with the device.

10.2 EUT ANTENNA

The EUT antenna is External antenna (antenna gain (A): 2dBi; antenna gain (B) : 2dBi). It comply with the standard requirement.

11. EUT TEST PHOTO

Conducted Measurement Photos



Radiated Measurement Photos

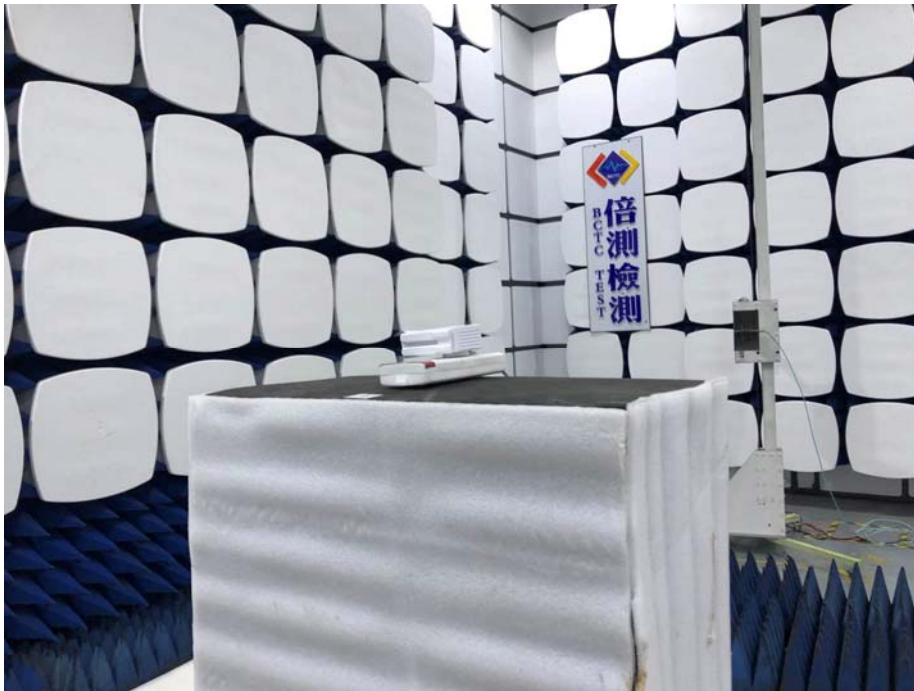



12. EUT PHOTO



S*** END OF REPORT *******