

# FCC Part 15C Test Report

## FCC ID: 2AXO4-MXC1-1200M

Product Name:	Repeater
Trademark:	BETA.IOT
Model Name :	MX-C1-1200M
Prepared For :	Shenzhen Mengxin Chuangfu Industrial Co., Ltd.
Address :	No. 257, Shangwu Avenue, Shangwu Community, Shiyuan Street, Baoan District, Shenzhen, China 518000
Prepared By :	Shenzhen BCTC Testing Co., Ltd.
Address :	BCTC Building & 1-2F, East of B Building, Pengzhou Industrial, Fuyuan 1st Road, Qiaotou Community, Fuyong Street, Bao'an District, Shenzhen, China
Test Date:	Aug. 14, 2020 – Aug. 31, 2020
Date of Report :	Aug. 31, 2020
Report No.:	BCTC2008001232E

## TEST RESULT CERTIFICATION

**Applicant's name** ..... : Shenzhen Mengxin Chuangfu Industrial Co., Ltd.  
**Address** ..... : No. 257, Shangwu Avenue, Shangwu Community, Shiyan Street,  
Baoan District, Shenzhen, China 518000

**Manufacture's Name** ..... : Shenzhen Mengxin Chuangfu Industrial Co., Ltd.  
**Address** ..... : No. 257, Shangwu Avenue, Shangwu Community, Shiyan Street,  
Baoan District, Shenzhen, China 518000

### Product description

**Product name** ..... : Repeater  
**Trademark** ..... : BETA.IOT  
**Model and/or type reference** : MX-C1-1200M

**Standards** ..... : FCC Part15.247  
ANSI C63.10:2013  
KDB 662911 D01 v02r01  
558074 D01 15.247 Meas Guidance v05r02

This device described above has been tested by BCTC, and the test results show that the equipment under test (EUT) is in compliance with the FCC requirements. And it is applicable only to the tested sample identified in the report.

This report shall not be reproduced except in full, without the written approval of BCTC, this document may be altered or revised by BCTC, personal only, and shall be noted in the revision of the document.

Prepared by(Engineer): Willem Wang

*Willem Wang*

Reviewer(Supervisor): Eric Yang

*Eric Yang*

Approved(Manager): Zero Zhou

*Zero Zhou*



<b>Table of Contents</b>		<b>Page</b>
<b>1 . SUMMARY OF TEST RESULTS</b>		<b>5</b>
1.1 TEST FACILITY		6
1.2 MEASUREMENT UNCERTAINTY		6
<b>2 . GENERAL INFORMATION</b>		<b>7</b>
2.1 GENERAL DESCRIPTION OF EUT		7
2.2 DESCRIPTION OF TEST MODES		8
2.3 BLOCK DIGRAM SHOWING THE CONFIGURATION OF SYSTEM TESTED		9
2.4 DESCRIPTION OF SUPPORT UNITS(CONDUCTED MODE)		9
2.5 EQUIPMENTS LIST FOR ALL TEST ITEMS		10
<b>3 . EMC EMISSION TEST</b>		<b>12</b>
3.1 CONDUCTED EMISSION MEASUREMENT		12
3.1.1 POWER LINE CONDUCTED EMISSION LIMITS		12
3.1.2 TEST PROCEDURE		12
3.1.3 DEVIATION FROM TEST STANDARD		12
3.1.4 TEST SETUP		13
3.1.5 EUT OPERATING CONDITIONS		13
3.1.6 TEST RESULTS		14
3.2 RADIATED EMISSION MEASUREMENT		16
3.2.1 RADIATED EMISSION LIMITS		16
3.2.2 TEST PROCEDURE		17
3.2.3 DEVIATION FROM TEST STANDARD		17
3.2.4 TEST SETUP		17
3.2.5 EUT OPERATING CONDITIONS		18
3.2.6 TEST RESULTS (BETWEEN 9KHZ – 30 MHZ)		19
3.2.7 TEST RESULTS (BETWEEN 30MHZ – 1GHZ)		20
3.2.8 TEST RESULTS (1GHZ~25GHZ)		22
3.3 RADIATED BAND EMISSION MEASUREMENT		28
3.3.1 TEST REQUIREMENT:		28
3.3.2 TEST PROCEDURE		28
3.3.3 DEVIATION FROM TEST STANDARD		29
3.3.4 TEST SETUP		29
3.3.5 EUT OPERATING CONDITIONS		29
<b>4 . POWER SPECTRAL DENSITY TEST</b>		<b>32</b>
4.1 APPLIED PROCEDURES / LIMIT		32
4.1.1 TEST PROCEDURE		32

<b>Table of Contents</b>		<b>Page</b>
4.1.2 DEVIATION FROM STANDARD		32
4.1.3 TEST SETUP		32
4.1.4 EUT OPERATION CONDITIONS		32
4.1.5 TEST RESULTS		33
<b>5 . BANDWIDTH TEST</b>		<b>41</b>
5.1 APPLIED PROCEDURES / LIMIT		41
5.1.1 TEST PROCEDURE		41
5.1.2 DEVIATION FROM STANDARD		41
5.1.3 TEST SETUP		41
5.1.4 EUT OPERATION CONDITIONS		41
5.1.5 TEST RESULTS		42
<b>6 . PEAK OUTPUT POWER TEST</b>		<b>50</b>
6.1 APPLIED PROCEDURES/LIMIT		50
6.1.1 TEST PROCEDURE		50
6.1.2 DEVIATION FROM STANDARD		50
6.1.3 TEST SETUP		50
6.1.4 EUT OPERATION CONDITIONS		50
6.1.5 TEST RESULTS		51
<b>7 . 100 KHZ BANDWIDTH OF FREQUENCY BAND EDGE</b>		<b>52</b>
7.1 APPLICABLE STANDARD		52
7.2 TEST PROCEDURE		52
7.3 DEVIATION FROM STANDARD		52
7.4 TEST SETUP		52
7.5 EUT OPERATION CONDITIONS		52
<b>8 . DUTY CYCLE OF TEST SIGNAL</b>		<b>61</b>
8.1 STANDARD REQUIREMENT		61
8.2 FORMULA:		61
<b>9 . ANTENNA REQUIREMENT</b>		<b>64</b>
9.1 STANDARD REQUIREMENT		64
9.2 EUT ANTENNA		64
<b>10 . EUT TEST PHOTO</b>		<b>65</b>
<b>11 . EUT PHOTO</b>		<b>67</b>
<b>APPENDIX-PHOTOGRAPHS OF EUT CONSTRUCTIONAL DETAILS</b>		

## 1. SUMMARY OF TEST RESULTS

Test procedures according to the technical standards:

FCC Part15 (15.247) , Subpart C			
Standard Section	Test Item	Judgment	Remark
15.207	Conducted Emission	PASS	
15.247 (a)(2)	6dB Bandwidth	PASS	
15.247 (b)	Peak Output Power	PASS	
15.247 (d)	Radiated Spurious Emission	PASS	
15.247 (e)	Power Spectral Density	PASS	
15.205	Restricted Band of Operation	PASS	
15.247 (d)	Band Edge (Out of Band Emissions)	PASS	
15.203	Antenna Requirement	PASS	

**NOTE:**

(1) "N/A" denotes test is not applicable in this Test Report

## 1.1 TEST FACILITY

Shenzhen BCTC Testing Co., Ltd.

Add. : BCTC Building & 1-2F, East of B Building, Pengzhou Industrial, Fuyuan 1st Road, Qiaotou Community, Fuyong Street, Bao'an District, Shenzhen, China

FCC Test Firm Registration Number: 712850

IC Registered No.: 23583

## 1.2 MEASUREMENT UNCERTAINTY

The reported uncertainty of measurement  $y \pm U$ , where expanded uncertainty  $U$  is based on a standard uncertainty multiplied by a coverage factor of  $k=2$ , providing a level of confidence of approximately **95 %**.

No.	Item	Uncertainty
1	3m chamber Radiated spurious emission(30MHz-1GHz)	U=4.3dB
2	3m chamber Radiated spurious emission(1GHz-18GHz)	U=4.5dB
3	3m chamber Radiated spurious emission(18GHz-40GHz)	U=3.34dB
4	Conducted Adjacent channel power	U=1.38dB
5	Conducted output power uncertainty Above 1G	U=1.576dB
6	Conducted output power uncertainty below 1G	U=1.28dB
7	humidity uncertainty	U=5.3%
8	Temperature uncertainty	U=0.59°C

## 2. GENERAL INFORMATION

### 2.1 GENERAL DESCRIPTION OF EUT

Equipment	Repeater	
Trade Name	BETA.IOT	
Model Name	MX-C1-1200M	
Model Difference	N/A	
Product Description	Operation Frequency:	802.11b/g/n20MHz:2412~2462 MHz 802.11n HT40: 2422-2452MHz
	Modulation Type:	WIFI: OFDM/DSSS
	Bit Rate of Transmitter	802.11b:11/5.5/2/1 Mbps 802.11g:54/48/36/24/18/12/9/6Mbps 802.11n Up to 75Mbps
	Number Of Channel	802.11b/g/n20MHz:11 CH 802.11n40MHz:7 CH
	Antenna Designation:	Please see Note 3.
Channel List	Please refer to the Note 2.	
Power Supply	AC 100-240V 50/60Hz	
hardware version	H1.0	
Software version	S1.0	
Connecting I/O Port(s)	Please refer to the User's Manual	

Note:

- For a more detailed features description, please refer to the manufacturer's specifications or the User's Manual.

2.

Channel List for 802.11b/g/n(20)							
Channel	Frequency (MHz)	Channel	Frequency (MHz)	Channel	Frequency (MHz)	Channel	Frequency (MHz)
01	2412	04	2427	07	2442	10	2457
02	2417	05	2432	08	2447	11	2462
03	2422	06	2437	09	2452		

Channel List for 802.11n(40)							
Channel	Frequency (MHz)	Channel	Frequency (MHz)	Channel	Frequency (MHz)	Channel	Frequency (MHz)
03	2422	05	2432	07	2442	09	2452
04	2427	06	2437	08	2447		

3.

Table for External antenna

Ant.	Brand	Model Name	Antenna Type	Gain (dBi)	NOTE
A	N/A	N/A	External antenna	2	
B	N/A	N/A	External antenna	2	

EUT has two External antennas with Max gain GANT 2dBi on every antenna, CDD device with two spatial streams, also can operat with one spatial streams according to KDB662911 D01 v02r01,

Directional gain= GANT + Array Gain, where Array Gain is as follows.

1) For power spectral density(PSD) measurements,

$$\text{Array Gain} = 10 \log(\text{NANT}/\text{NSS}) \text{dB} = 10 \log(2/1) = 3.01 \text{dB},$$

So the directional gain for PSD is 5.01dBi

2) For power measurements,

$$\text{The Array gain} = 0 \text{ dB for } \text{NANT} \leq 4,$$

So the directional gain for Power measurements is 2dBi

## 2.2 DESCRIPTION OF TEST MODES

Pretest Mode	Description
Mode 1	802.11b CH1/ CH6/ CH11
Mode 2	802.11g CH1/ CH6/ CH11
Mode 3	802.11n20 CH1/ CH6/ CH11
Mode 4	802.11n40 CH3/ CH6/ CH9
Mode 5	Link Mode

Conducted Emission	
Final Test Mode	Description
Mode 5	Link Mode

For Radiated Emission	
Final Test Mode	Description
Mode 1	802.11b CH1/ CH6/ CH11
Mode 2	802.11g CH1/ CH6/ CH11



Mode 3	802.11n20 CH1/ CH6/ CH11
Mode 4	802.11n40 CH3/ CH6/ CH9

Note:

(1) The measurements are performed at all Bit Rate of Transmitter, the worst data was reported.

### 2.3 BLOCK DIGRAM SHOWING THE CONFIGURATION OF SYSTEM TESTED

Conducted Emission Test

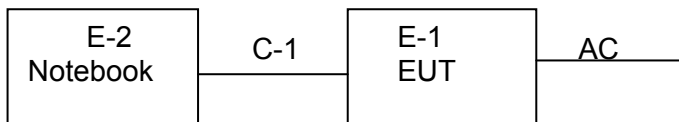

Radiated Spurious Emission

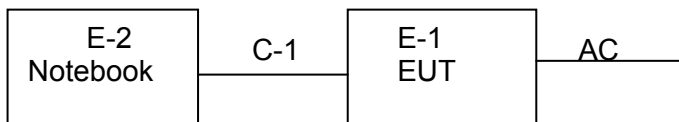

### 2.4 DESCRIPTION OF SUPPORT UNITS(CONDUCTED MODE)

The EUT has been tested as an independent unit together with other necessary accessories or support units. The following support units or accessories were used to form a representative test configuration during the tests.

Item	Equipment	Mfr/Brand	Model/Type No.	Series No.	Note
E-1	Repeater	BETA.IOT	MX-C1-1200M	N/A	EUT
E-2	Notebook	N/A	NOTE001	N/A	Auxiliary

Item	Shielded Type	Ferrite Core	Length	Note
C-1	NO	NO	0.5	Ethernet cable

Note:

- (1) The support equipment was authorized by Declaration of Confirmation.
- (2) For detachable type I/O cable should be specified the length in cm in 『Length』 column.

## 2.5 EQUIPMENTS LIST FOR ALL TEST ITEMS

### Radiation Test equipment

Item	Equipment	Manufacturer	Type No.	Serial No.	Last calibration	Calibrated until
1	Spectrum Analyzer (9kHz-26.5GHz)	Agilent	E4407B	MY45109572	Jun. 08, 2020	Jun. 07, 2021
2	Test Receiver (9kHz-7GHz)	R&S	ESR7	101154	Jun. 08, 2020	Jun. 07, 2021
3	Bilog Antenna (30MHz-3GHz)	SCHWARZBECK	VULB9163	VULB9163-942	Jun. 08, 2020	Jun. 07, 2021
4	Horn Antenna (1GHz-18GHz)	SCHWARZBECK	BBHA9120D	1541	Jun. 10, 2020	Jun. 09, 2021
5	Horn Antenna (18GHz-40GHz)	SCHWARZBECK	BBHA9170	00822	Jun. 10, 2020	Jun. 09, 2021
6	Amplifier (9KHz-6GHz)	SCHWARZBECK	BBV9744	9744-0037	Jun. 04, 2020	Jun. 03, 2021
7	Amplifier (0.5GHz-18GHz)	SCHWARZBECK	BBV9718	9718-309	Jun. 04, 2020	Jun. 03, 2021
8	Amplifier (18GHz-40GHz)	MITEQ	TTA1840-35-HG	2034381	Jun. 08, 2020	Jun. 07, 2021
9	Loop Antenna (9KHz-30MHz)	SCHWARZBECK	FMZB1519B	00014	Jun. 08, 2020	Jun. 07, 2021
10	RF cables1 (9kHz-30MHz)	Huber+Suhnar	9kHz-30MHz	B1702988-0008	Jun. 08, 2020	Jun. 07, 2021
11	RF cables2 (30MHz-1GHz)	Huber+Suhnar	30MHz-1GHz	1486150	Jun. 08, 2020	Jun. 07, 2021
12	RF cables3 (1GHz-40GHz)	Huber+Suhnar	1GHz-40GHz	1607106	Jun. 08, 2020	Jun. 07, 2021
13	Power Metter	Keysight	E4419B	\	Jun. 08, 2020	Jun. 07, 2021
14	Power Sensor (AV)	Keysight	E9 300A	\	Jun. 08, 2020	Jun. 07, 2021
15	Signal Analyzer 20kHz-26.5GHz	KEYSIGHT	N9020A	MY49100060	Jun. 04, 2020	Jun. 03, 2021
16	Spectrum Analyzer 9kHz-40GHz	Agilent	FSP40	100363	Jun. 13, 2020	Jun. 12, 2021
17	D.C. Power Supply	LongWei	TPR-6405D	\	\	\
18	Software	Frad	EZ-EMC	FA-03A2 RE	\	\

## Conduction Test equipment

Item	Equipment	Manufacturer	Type No.	Serial No.	Last calibration	Calibrated until
1	Test Receiver	R&S	ESR3	102075	Jun. 08, 2020	Jun. 07, 2021
2	LISN	SCHWARZBECK	NSLK8127	8127739	Jun. 13, 2020	Jun. 12, 2021
3	LISN	R&S	ENV216	101375	Jun. 04, 2020	Jun. 03, 2021
4	RF cables	Huber+Suhnar	9kHz-30MHz	B1702988-0008	Jun. 08, 2020	Jun. 07, 2021
5	Software	Frad	EZ-EMC	EMC-CON 3A1	\	\

### 3. EMC EMISSION TEST

#### 3.1 CONDUCTED EMISSION MEASUREMENT

##### 3.1.1 POWER LINE CONDUCTED EMISSION Limits (Frequency Range 150KHz-30MHz)

FREQUENCY (MHz)	Limit (dBuV)		Standard
	Quasi-peak	Average	
0.15 -0.5	66 - 56 *	56 - 46 *	FCC
0.50 -5.0	56.00	46.00	FCC
5.0 -30.0	60.00	50.00	FCC

Note:

- (1) The tighter limit applies at the band edges.
- (2) The limit of " \* " marked band means the limitation decreases linearly with the logarithm of the frequency in the range.

The following table is the setting of the receiver

Receiver Parameters	Setting
Attenuation	10 dB
Start Frequency	0.15 MHz
Stop Frequency	30 MHz
IF Bandwidth	9 kHz

##### 3.1.2 TEST PROCEDURE

- a. The EUT was placed 0.8 meters from the horizontal ground plane with EUT being connected to the power mains through a line impedance stabilization network (LISN). All other support equipments powered from additional LISN(s). The LISN provide 50 Ohm/ 50uH of coupling impedance for the measuring instrument.
- b. Interconnecting cables that hang closer than 40 cm to the ground plane shall be folded back and forth in the center forming a bundle 30 to 40 cm long.
- c. I/O cables that are not connected to a peripheral shall be bundled in the center. The end of the cable may be terminated, if required, using the correct terminating impedance. The overall length shall not exceed 1 m.
- d. LISN at least 80 cm from nearest part of EUT chassis.
- e. For the actual test configuration, please refer to the related Item –EUT Test Photos.

##### 3.1.3 DEVIATION FROM TEST STANDARD

No deviation

### 3.1.4 TEST SETUP

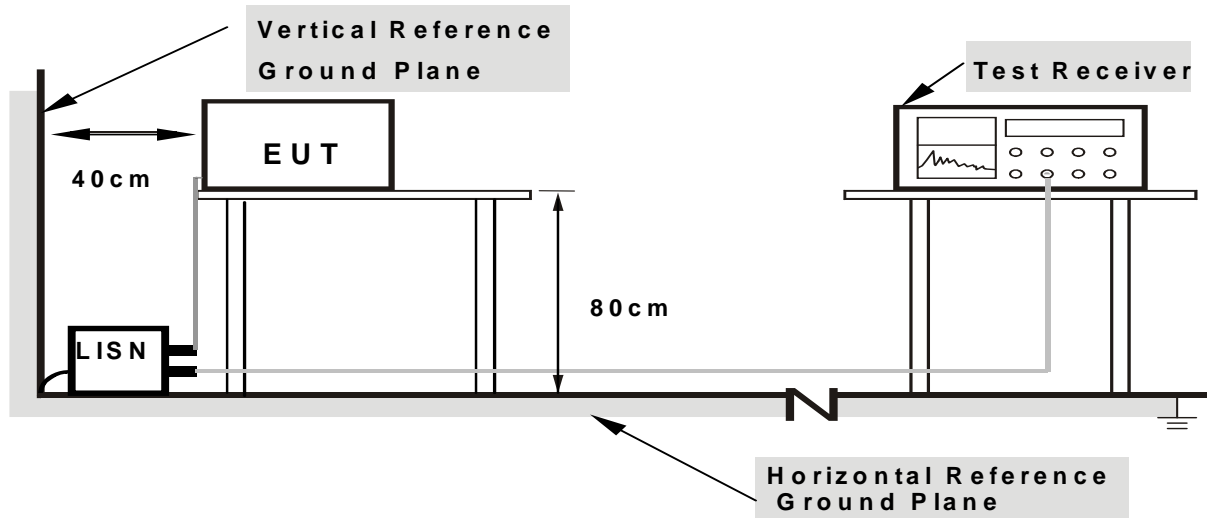

Note: 1.Support units were connected to second LISN.

2.Both of LISNs (AMN) are 80 cm from EUT and at least 80 from other units and other metal planes

### 3.1.5 EUT OPERATING CONDITIONS

The EUT was configured for testing in a typical fashion (as a customer would normally use it). The EUT has been programmed to continuously transmit during test. This operating condition was tested and used to collect the included data.

We pretest AC 120V and AC 240V, the worst voltage was AC 120V and the data recording in the report.

### 3.1.6 TEST RESULTS

Temperature :	26 °C	Relative Humidity :	54%
Pressure :	101kPa	Phase :	L
Test Voltage :	AC 120V 60Hz	Test Mode :	Mode 5

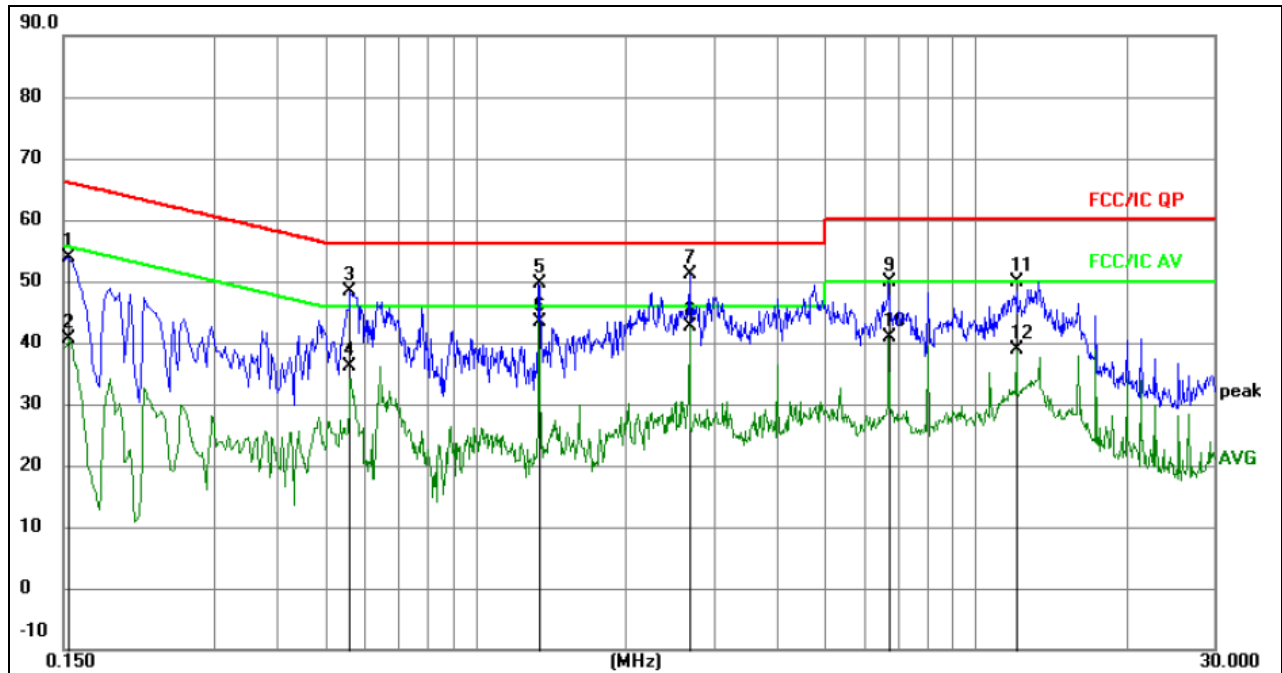

Remark:

1. All readings are Quasi-Peak and Average values.
2. Factor = Insertion Loss + Cable Loss.

No.	Mk.	Freq.	Reading Level	Correct Factor	Measurement	Limit	Over	Detector	Comment
		MHz		dB	dBuV	dBuV	dB		
1		0.1539	44.31	9.52	53.83	65.79	-11.96	QP	
2		0.1539	31.05	9.52	40.57	55.79	-15.22	AVG	
3		0.5611	38.42	9.84	48.26	56.00	-7.74	QP	
4		0.5611	26.22	9.84	36.06	46.00	-9.94	AVG	
5		1.3379	40.07	9.58	49.65	56.00	-6.35	QP	
6	*	1.3379	33.72	9.58	43.30	46.00	-2.70	AVG	
7		2.6783	41.49	9.64	51.13	56.00	-4.87	QP	
8		2.6783	32.87	9.64	42.51	46.00	-3.49	AVG	
9		6.6978	40.20	9.73	49.93	60.00	-10.07	QP	
10		6.6978	31.20	9.73	40.93	50.00	-9.07	AVG	
11		12.0599	40.27	9.69	49.96	60.00	-10.04	QP	
12		12.0599	29.16	9.69	38.85	50.00	-11.15	AVG	

Temperature :	26 °C	Relative Humidity :	54%
Pressure :	101kPa	Phase :	N
Test Voltage :	AC 120V 60Hz	Test Mode :	Mode 5

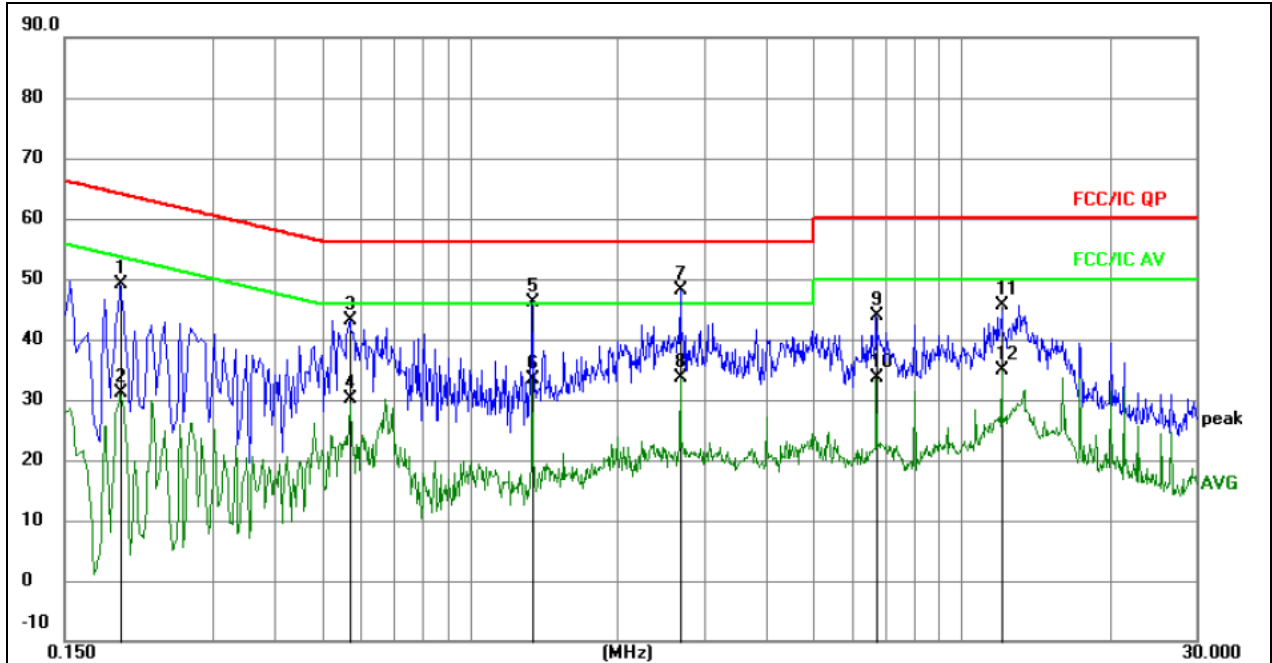
**Remark:**

1. All readings are Quasi-Peak and Average values.
2. Factor = Insertion Loss + Cable Loss.

No.	Mk.	Freq.	Reading Level	Correct Factor	Measurement	Limit	Over	Detector	Comment
		MHz		dB	dBuV	dBuV	dB		
1		0.1949	39.60	9.47	49.07	63.83	-14.76	QP	
2		0.1949	21.70	9.47	31.17	53.83	-22.66	AVG	
3		0.5730	33.33	9.89	43.22	56.00	-12.78	QP	
4		0.5730	20.20	9.89	30.09	46.00	-15.91	AVG	
5		1.3425	36.62	9.58	46.20	56.00	-9.80	QP	
6		1.3425	23.87	9.58	33.45	46.00	-12.55	AVG	
7	*	2.6835	38.59	9.64	48.23	56.00	-7.77	QP	
8		2.6835	23.89	9.64	33.53	46.00	-12.47	AVG	
9		6.7065	34.26	9.73	43.99	60.00	-16.01	QP	
10		6.7065	23.90	9.73	33.63	50.00	-16.37	AVG	
11		12.0705	35.84	9.69	45.53	60.00	-14.47	QP	
12		12.0705	25.13	9.69	34.82	50.00	-15.18	AVG	

### 3.2 RADIATED EMISSION MEASUREMENT

#### 3.2.1 RADIATED EMISSION LIMITS (Frequency Range 9kHz-1000MHz)

20dBc in any 100 kHz bandwidth outside the operating frequency band. In case the emission fall within the restricted band specified on 15.205(a), then the 15.209(a) limit in the table below has to be followed.

Frequencies (MHz)	Field Strength (micorvolts/meter)	Measurement Distance (meters)
0.009~0.490	2400/F(KHz)	300
0.490~1.705	24000/F(KHz)	30
1.705~30.0	30	30
30~88	100	3
88~216	150	3
216~960	200	3
Above 960	500	3

#### LIMITS OF RADIATED EMISSION MEASUREMENT (Above 1000MHz)

FREQUENCY (MHz)	Limit (dBuV/m) (at 3M)	
	PEAK	AVERAGE
Above 1000	74	54

Notes:

- (1) The limit for radiated test was performed according to FCC PART 15C.
- (2) The tighter limit applies at the band edges.
- (3) Emission level (dBuV/m)=20log Emission level (uV/m).

Spectrum Parameter	Setting
Attenuation	Auto
Start Frequency	1000 MHz
Stop Frequency	25GHz
RB / VB (emission in restricted band)	1 MHz / 1 MHz for Peak, 1 MHz / 10Hz for Average

Receiver Parameter	Setting
Attenuation	Auto
Start ~ Stop Frequency	9kHz~150kHz / RB 200Hz for QP
Start ~ Stop Frequency	150kHz~30MHz / RB 9kHz for QP
Start ~ Stop Frequency	30MHz~1000MHz / RB 120kHz for QP



### 3.2.2 TEST PROCEDURE

Below 1GHz test procedure as below:

- a. The EUT was placed on the top of a rotating table 0.8 meters above the ground at a 3 meter semi-anechoic chamber. The table was rotated 360 degrees to determine the position of the highest radiation.
- b. The EUT was set 3 meters away from the interference-receiving antenna, which was mounted on the top of a variable-height antenna tower.
- c. The antenna height is varied from one meter to four meters above the ground to determine the maximum value of the field strength. Both horizontal and vertical polarizations of the antenna are set to make the measurement.
- d. For each suspected emission, the EUT was arranged to its worst case and then the antenna was tuned to heights from 1 meter to 4 meters (for the test frequency of below 30MHz, the antenna was tuned to heights 1 meter) and the rotatable table was turned from 0 degrees to 360 degrees to find the maximum reading.
- e. The test-receiver system was set to Peak Detect Function and Specified Bandwidth with Maximum Hold Mode.
- f. If the emission level of the EUT in peak mode was 10dB lower than the limit specified, then testing could be stopped and the peak values of the EUT would be reported. Otherwise the emissions that did not have 10dB margin would be re-tested one by one using peak, quasi-peak or average method as specified and then reported in a data sheet.

Above 1GHz test procedure as below:

- g. Different between above is the test site, change from Semi- Anechoic Chamber to fully Anechoic Chamber and change form table 0.8 metre to 1.5 metre( Above 18GHz the distance is 1 meter and table is 1.5 metre).
- h. Test the EUT in the lowest channel ,the middle channel ,the Highest channel

Note:

Both horizontal and vertical antenna polarities were tested and performed pretest to three orthogonal axis. The worst case emissions were reported

### 3.2.3 DEVIATION FROM TEST STANDARD

No deviation

### 3.2.4 TEST SETUP

(A) Radiated Emission Test-Up Frequency Below 30MHz

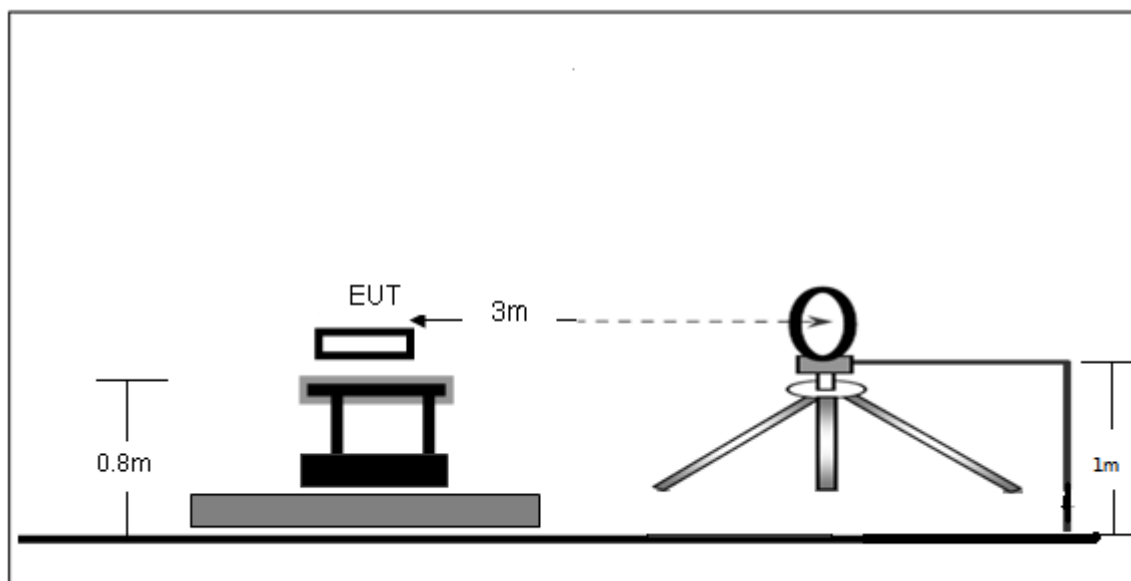

(B) Radiated Emission Test-Up Frequency 30MHz~1GHz

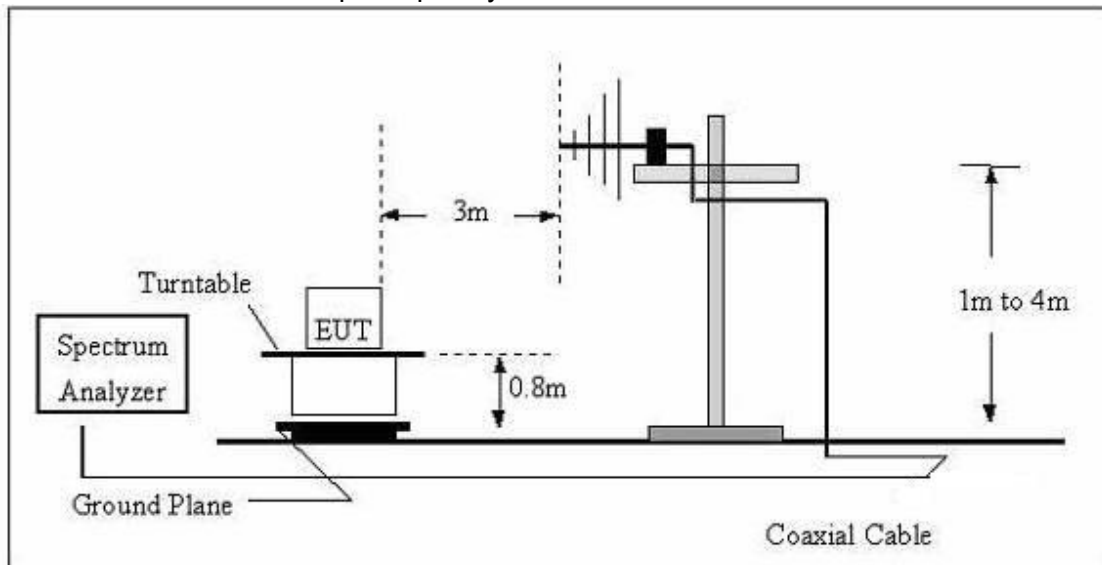

(C) Radiated Emission Test-Up Frequency Above 1GHz

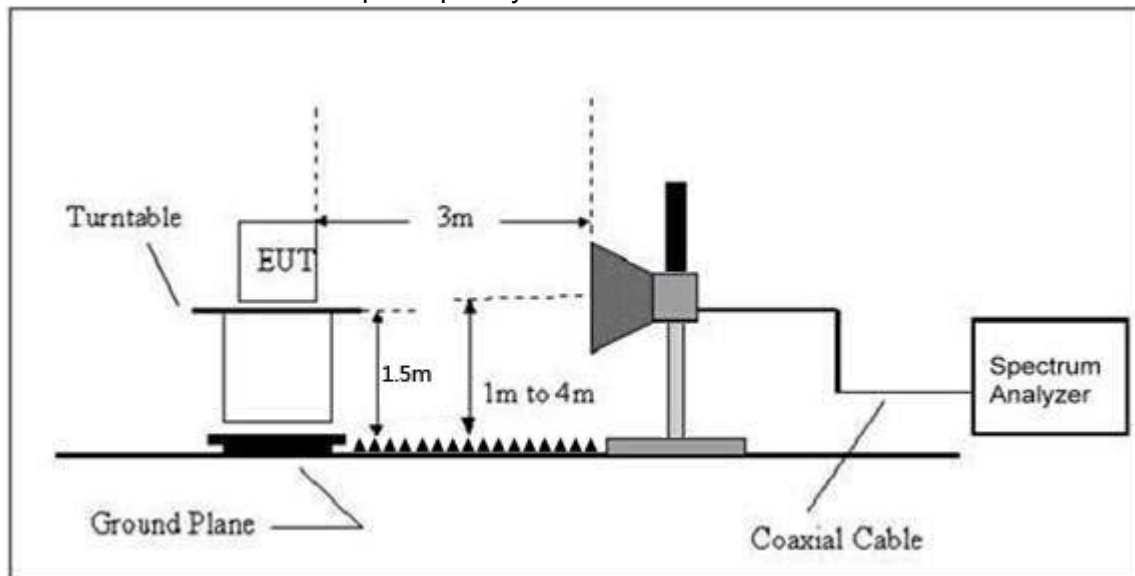

**3.2.5 EUT OPERATING CONDITIONS**

The EUT tested system was configured as the statements of 2.4 Unless otherwise a special operating condition is specified in the follows during the testing.

### 3.2.6 TEST RESULTS (BETWEEN 9KHZ – 30 MHZ)

Temperature:	26 °C	Relative Humidity :	54%
Pressure:	101kPa	Test Voltage :	AC 120V 60Hz
Test Mode :	Mode 5	Polarization :	--

Freq.	Reading	Limit	Margin	State
(MHz)	(dBuV/m)	(dBuV/m)	(dB)	P/F
--	--	--	--	PASS
--	--	--	--	PASS

#### NOTE:

The amplitude of spurious emissions which are attenuated by more than 20dB below the permissible value has no need to be reported.

Distance extrapolation factor =  $40 \log(\text{specific distance}/\text{test distance})$ (dB);

Limit line = specific limits(dBuv) + distance extrapolation factor.

### 3.2.7 TEST RESULTS (BETWEEN 30MHZ – 1GHZ)

Temperature :	26 °C	Relative Humidity :	54%
Pressure :	101 kPa	Polarization :	Horizontal
Test Voltage :	AC 120V 60Hz	Test Mode :	Mode 5

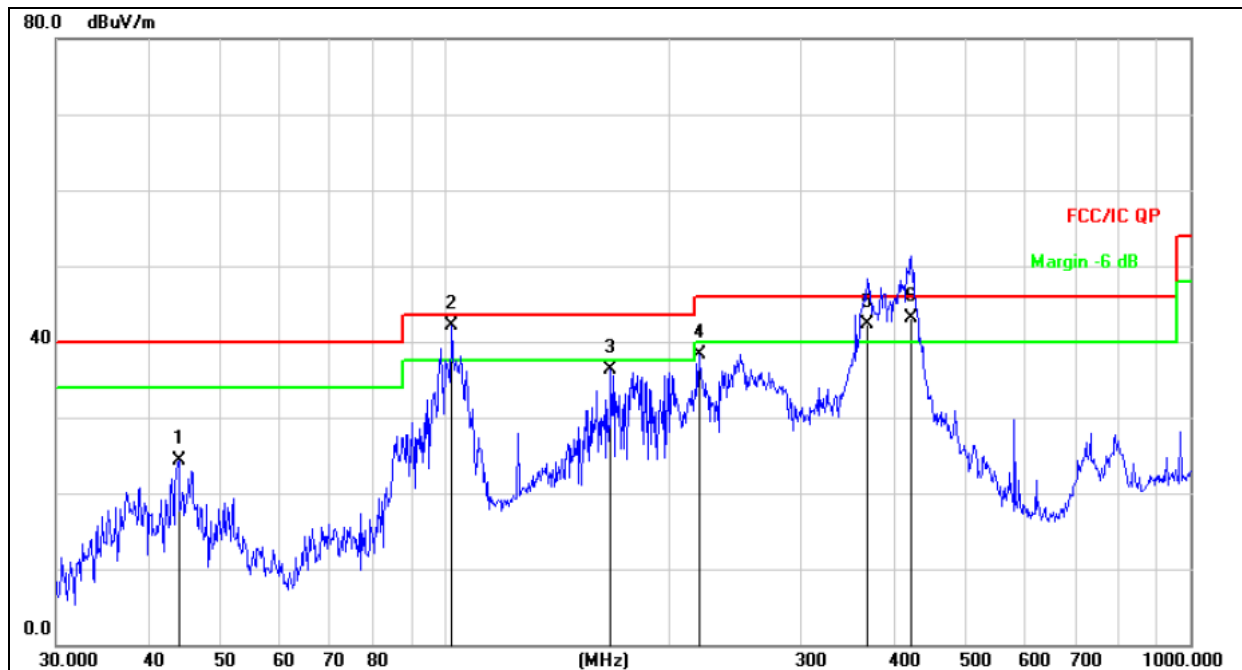

Remark:

Factor = Antenna Factor + Cable Loss – Pre-amplifier.

No.	Mk.	Freq. MHz	Reading Level dBuV	Correct Factor dB	Measure- ment dBuV/m	Limit dB/m	Over dB	Detector
1		43.8119	39.48	-15.20	24.28	40.00	-15.72	QP
2	*	102.0014	58.50	-16.41	42.09	43.50	-1.41	QP
3		166.6514	54.71	-18.43	36.28	43.50	-7.22	QP
4		219.0753	54.24	-15.86	38.38	46.00	-7.62	QP
5	!	368.1116	54.18	-11.82	42.36	46.00	-3.64	QP
6	!	421.7650	53.78	-10.60	43.18	46.00	-2.82	QP

Temperature :	26 °C	Relative Humidity :	54%
Pressure :	101kPa	Polarization :	Vertical
Test Voltage :	AC 120V 60Hz	Test Mode :	Mode 5

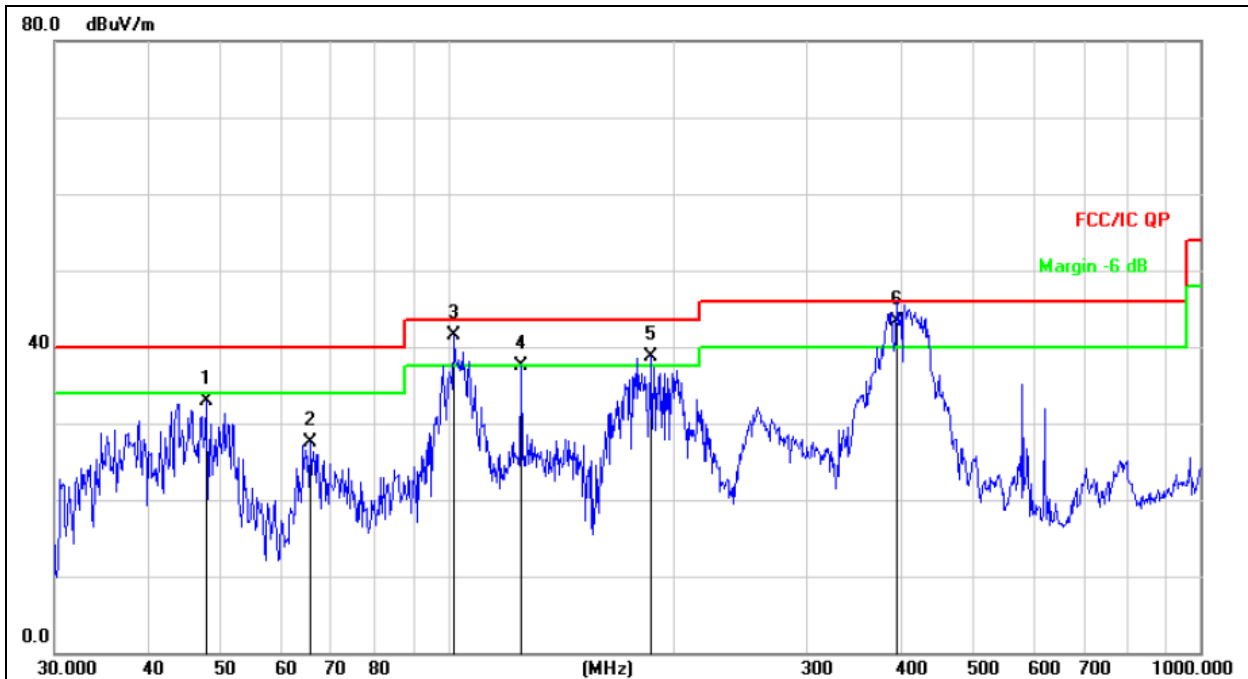

Remark:

Factor = Antenna Factor + Cable Loss – Pre-amplifier.

No.	Mk.	Freq. MHz	Reading Level dBuV	Correct Factor dB	Measure- ment dBuV/m	Limit dB/m	Over dB	Detector
1		47.8260	47.87	-14.97	32.90	40.00	-7.10	QP
2		65.5727	44.61	-17.18	27.43	40.00	-12.57	QP
3	*	102.0014	57.82	-16.41	41.41	43.50	-2.09	QP
4		125.0066	55.38	-17.89	37.49	43.50	-6.01	QP
5	!	186.4409	55.83	-17.17	38.66	43.50	-4.84	QP
6	!	394.8545	54.47	-11.21	43.26	46.00	-2.74	QP

**3.2.8 TEST RESULTS (1GHZ~25GHZ)**
**802.11b**

Polar (H/V)	Frequency	Meter Reading	Pre-amplifier	Cable Loss	Antenna Factor	Emission Level	Limits	Margin	Detector Type
	(MHz)	(dBuV)	(dB)	(dB)	(dB)	(dBuV/m)	(dBuV/m)	(dB)	
Low Channel:2412MHz									
V	4824.00	55.51	39.55	7.85	25.66	49.47	74.00	-24.53	PK
V	4824.00	51.36	39.55	7.85	25.66	45.32	54.00	-8.68	AV
V	7236.00	54.23	38.33	7.52	24.55	47.97	74.00	-26.03	PK
V	7236.00	48.99	38.33	7.52	24.55	42.73	54.00	-11.27	AV
H	4824.00	54.16	39.55	7.85	25.66	48.12	74.00	-25.88	PK
H	4824.00	46.53	39.55	7.85	25.66	40.49	54.00	-13.51	AV
H	7236.00	55.38	38.33	7.52	24.55	49.12	74.00	-24.88	PK
H	7236.00	48.09	38.33	7.52	24.55	41.83	54.00	-12.17	AV

Polar (H/V)	Frequency	Meter Reading	Pre-amplifier	Cable Loss	Antenna Factor	Emission Level	Limits	Margin	Detector Type
	(MHz)	(dBuV)	(dB)	(dB)	(dB)	(dBuV/m)	(dBuV/m)	(dB)	
Middle Channel:2437MHz									
V	4874.00	55.58	38.89	7.57	25.45	49.71	74.00	-24.29	Pk
V	4874.00	50.44	38.89	7.57	25.45	44.57	54.00	-9.43	AV
V	7311.00	55.84	38.78	7.35	24.54	48.95	74.00	-25.05	Pk
V	7311.00	48.29	38.78	7.35	24.54	41.40	54.00	-12.60	AV
H	4874.00	55.48	38.89	7.57	25.45	49.61	74.00	-24.39	Pk
H	4874.00	47.41	38.89	7.57	25.45	41.54	54.00	-12.46	AV
H	7311.00	55.97	38.78	7.35	24.54	49.08	74.00	-24.92	Pk
H	7311.00	45.16	38.78	7.35	24.54	38.27	54.00	-15.73	AV

Polar (H/V)	Frequency	Meter Reading	Pre-amplifier	Cable Loss	Antenna Factor	Emission Level	Limits	Margin	Detector Type
	(MHz)	(dBuV)	(dB)	(dB)	(dB)	(dBuV/m)	(dBuV/m)	(dB)	
High Channel: 2462MHz									
V	4924.00	56.39	38.75	7.46	25.41	50.51	74.00	-23.49	PK
V	4924.00	50.73	38.75	7.46	25.41	44.85	54.00	-9.15	AV
V	7386.00	56.50	38.65	7.22	24.52	49.59	74.00	-24.41	PK
V	7386.00	50.13	38.65	7.22	24.52	43.22	54.00	-10.78	AV
H	4924.00	55.96	38.75	7.46	25.41	50.08	74.00	-23.92	PK
H	4924.00	46.53	38.75	7.46	25.41	40.65	54.00	-13.35	AV
H	7386.00	54.93	38.65	7.22	24.52	48.02	74.00	-25.98	PK
H	7386.00	44.84	38.65	7.22	24.52	37.93	54.00	-16.07	AV

Remark:

1. Emission Level = Meter Reading + Antenna Factor + Cable Loss – Pre-amplifier,

Margin= Emission Level - Limit

2. If peak below the average limit, the average emission was no test.

3. The amplitude of spurious emissions which are attenuated by more than 20dB below the permissible value has no need to be reported.

4. The worst case is Antenna A.

**802.11g**

Polar (H/V)	Frequency	Meter Reading	Pre-amplifier	Cable Loss	Antenna Factor	Emission Level	Limits	Margin	Detector Type
	(MHz)	(dBuV)	(dB)	(dB)	(dB)	(dBuV/m)	(dBuV/m)	(dB)	
Low Channel:2412MHz									
V	4824.00	54.47	39.55	7.85	25.66	48.43	74.00	-25.57	PK
V	4824.00	49.91	39.55	7.85	25.66	43.87	54.00	-10.13	AV
V	7236.00	53.87	38.33	7.52	24.55	47.61	74.00	-26.39	PK
V	7236.00	49.68	38.33	7.52	24.55	43.42	54.00	-10.58	AV
H	4824.00	54.87	39.55	7.85	25.66	48.83	74.00	-25.17	PK
H	4824.00	46.00	39.55	7.85	25.66	39.96	54.00	-14.04	AV
H	7236.00	54.73	38.33	7.52	24.55	48.47	74.00	-25.53	PK
H	7236.00	45.00	38.33	7.52	24.55	38.74	54.00	-15.26	AV

Polar (H/V)	Frequency	Meter Reading	Pre-amplifier	Cable Loss	Antenna Factor	Emission Level	Limits	Margin	Detector Type
	(MHz)	(dBuV)	(dB)	(dB)	(dB)	(dBuV/m)	(dBuV/m)	(dB)	
Middle Channel:2437MHz									
V	4874.00	54.77	38.89	7.57	25.45	48.90	74.00	-25.10	PK
V	4874.00	51.24	38.89	7.57	25.45	45.37	54.00	-8.63	AV
V	7311.00	54.43	38.78	7.35	24.54	47.54	74.00	-26.46	PK
V	7311.00	48.47	38.78	7.35	24.54	41.58	54.00	-12.42	AV
H	4874.00	55.72	38.89	7.57	25.45	49.85	74.00	-24.15	PK
H	4874.00	46.55	38.89	7.57	25.45	40.68	54.00	-13.32	AV
H	7311.00	55.00	38.78	7.35	24.54	48.11	74.00	-25.89	PK
H	7311.00	48.02	38.78	7.35	24.54	41.13	54.00	-12.87	AV

Polar (H/V)	Frequency	Meter Reading	Pre-amplifier	Cable Loss	Antenna Factor	Emission Level	Limits	Margin	Detector Type
	(MHz)	(dBuV)	(dB)	(dB)	(dB)	(dBuV/m)	(dBuV/m)	(dB)	
High Channel: 2462MHz									
V	4924.00	55.47	38.75	7.46	25.41	49.59	74.00	-24.41	PK
V	4924.00	50.61	38.75	7.46	25.41	44.73	54.00	-9.27	AV
V	7386.00	54.54	38.65	7.22	24.52	47.63	74.00	-26.37	PK
V	7386.00	49.99	38.65	7.22	24.52	43.08	54.00	-10.92	AV
H	4924.00	54.96	38.75	7.46	25.41	49.08	74.00	-24.92	PK
H	4924.00	46.15	38.75	7.46	25.41	40.27	54.00	-13.73	AV
H	7386.00	55.01	38.65	7.22	24.52	48.10	74.00	-25.90	PK
H	7386.00	45.16	38.65	7.22	24.52	38.25	54.00	-15.75	AV

Remark:

1. Emission Level = Meter Reading + Antenna Factor + Cable Loss – Pre-amplifier,  
Margin= Emission Level - Limit
2. If peak below the average limit, the average emission was no test.
3. The amplitude of spurious emissions which are attenuated by more than 20dB below the permissible value has no need to be reported.
4. The worst case is Antenna A.

**802.11n(20MHz)**

Polar (H/V)	Frequency	Meter Reading	Pre-amplifier	Cable Loss	Antenna Factor	Emission Level	Limits	Margin	Detector Type
	(MHz)	(dBuV)	(dB)	(dB)	(dB)	(dBuV/m)	(dBuV/m)	(dB)	
Low Channel:2412MHz									
V	4824.00	51.72	39.55	7.85	25.66	45.68	74.00	-28.32	PK
V	4824.00	47.55	39.55	7.85	25.66	41.51	54.00	-12.49	AV
V	7236.00	52.50	38.33	7.52	24.55	46.24	74.00	-27.76	PK
V	7236.00	46.17	38.33	7.52	24.55	39.91	54.00	-14.09	AV
H	4824.00	51.36	39.55	7.85	25.66	45.32	74.00	-28.68	PK
H	4824.00	44.71	39.55	7.85	25.66	38.67	54.00	-15.33	AV
H	7236.00	51.44	38.33	7.52	24.55	45.18	74.00	-28.82	PK
H	7236.00	43.90	38.33	7.52	24.55	37.64	54.00	-16.36	AV

Polar (H/V)	Frequency	Meter Reading	Pre-amplifier	Cable Loss	Antenna Factor	Emission Level	Limits	Margin	Detector Type
	(MHz)	(dBuV)	(dB)	(dB)	(dB)	(dBuV/m)	(dBuV/m)	(dB)	
Middle Channel:2437MHz									
V	4874.00	52.37	38.89	7.57	25.45	46.50	74.00	-27.50	PK
V	4874.00	46.24	38.89	7.57	25.45	40.37	54.00	-13.63	AV
V	7311.00	52.91	38.78	7.35	24.54	46.02	74.00	-27.98	PK
V	7311.00	45.94	38.78	7.35	24.54	39.05	54.00	-14.95	AV
H	4874.00	52.42	38.89	7.57	25.45	46.55	74.00	-27.45	PK
H	4874.00	43.04	38.89	7.57	25.45	37.17	54.00	-16.83	AV
H	7311.00	50.84	38.78	7.35	24.54	43.95	74.00	-30.05	PK
H	7311.00	40.34	38.78	7.35	24.54	33.45	54.00	-20.55	AV

Polar (H/V)	Frequency	Meter Reading	Pre-amplifier	Cable Loss	Antenna Factor	Emission Level	Limits	Margin	Detector Type
	(MHz)	(dBuV)	(dB)	(dB)	(dB)	(dBuV/m)	(dBuV/m)	(dB)	
High Channel: 2462MHz									
V	4924.00	52.26	38.75	7.46	25.41	46.38	74.00	-27.62	PK
V	4924.00	46.76	38.75	7.46	25.41	40.88	54.00	-13.12	AV
V	7386.00	53.52	38.65	7.22	24.52	46.61	74.00	-27.39	PK
V	7386.00	44.86	38.65	7.22	24.52	37.95	54.00	-16.05	AV
H	4924.00	52.52	38.75	7.46	25.41	46.64	74.00	-27.36	PK
H	4924.00	41.80	38.75	7.46	25.41	35.92	54.00	-18.08	AV
H	7386.00	52.64	38.65	7.22	24.52	45.73	74.00	-28.27	PK
H	7386.00	42.69	38.65	7.22	24.52	35.78	54.00	-18.22	AV

Remark:

1. Emission Level = Meter Reading + Antenna Factor + Cable Loss – Pre-amplifier,  
Margin= Emission Level - Limit
2. If peak below the average limit, the average emission was no test.
3. The amplitude of spurious emissions which are attenuated by more than 20dB below the permissible value has no need to be reported.
4. The worst case is Antenna A.



**802.11n(40MHz)**

Polar (H/V)	Frequency	Meter Reading	Pre-amplifier	Cable Loss	Antenna Factor	Emission Level	Limits	Margin	Detector Type
	(MHz)	(dBuV)	(dB)	(dB)	(dB)	(dBuV/m)	(dBuV/m)	(dB)	
Low Channel:2422MHz									
V	4844.00	52.34	39.55	7.77	25.66	46.22	74.00	-27.78	PK
V	4844.00	47.65	39.55	7.77	25.66	41.53	54.00	-12.47	AV
V	7266.00	52.62	38.33	7.30	24.55	46.14	74.00	-27.86	PK
V	7266.00	45.93	38.33	7.30	24.55	39.45	54.00	-14.55	AV
H	4844.00	51.66	39.55	7.77	25.66	45.54	74.00	-28.46	PK
H	4844.00	43.41	39.55	7.77	25.66	37.29	54.00	-16.71	AV
H	7266.00	52.93	38.33	7.30	24.55	46.45	74.00	-27.55	PK
H	7266.00	42.19	38.33	7.30	24.55	35.71	54.00	-18.29	AV

Polar (H/V)	Frequency	Meter Reading	Pre-amplifier	Cable Loss	Antenna Factor	Emission Level	Limits	Margin	Detector Type
	(MHz)	(dBuV)	(dB)	(dB)	(dB)	(dBuV/m)	(dBuV/m)	(dB)	
Middle Channel:2437MHz									
V	4874.00	53.06	38.89	7.57	25.45	47.19	74.00	-26.81	PK
V	4874.00	48.45	38.89	7.57	25.45	42.58	54.00	-11.42	AV
V	7311.00	51.83	38.78	7.35	24.54	44.94	74.00	-29.06	PK
V	7311.00	45.78	38.78	7.35	24.54	38.89	54.00	-15.11	AV
H	4874.00	52.89	38.89	7.57	25.45	47.02	74.00	-26.98	PK
H	4874.00	44.02	38.89	7.57	25.45	38.15	54.00	-15.85	AV
H	7311.00	52.88	38.78	7.35	24.54	45.99	74.00	-28.01	PK
H	7311.00	44.95	38.78	7.35	24.54	38.06	54.00	-15.94	AV

Polar (H/V)	Frequency	Meter Reading	Pre-amplifier	Cable Loss	Antenna Factor	Emission Level	Limits	Margin	Detector Type
	(MHz)	(dBuV)	(dB)	(dB)	(dB)	(dBuV/m)	(dBuV/m)	(dB)	
High Channel: 2452MHz									
V	4904.00	53.52	38.75	7.38	25.41	47.56	74.00	-26.44	PK
V	4904.00	46.99	38.75	7.38	25.41	41.03	54.00	-12.97	AV
V	7356.00	52.08	38.65	7.15	24.52	45.10	74.00	-28.90	PK
V	7356.00	46.01	38.65	7.15	24.52	39.03	54.00	-14.97	AV
H	4904.00	52.90	38.75	7.38	25.41	46.94	74.00	-27.06	PK
H	4904.00	44.16	38.75	7.38	25.41	38.20	54.00	-15.80	AV
H	7356.00	52.47	38.65	7.15	24.52	45.49	74.00	-28.51	PK
H	7356.00	43.44	38.65	7.15	24.52	36.46	54.00	-17.54	AV

Remark:

- Emission Level = Meter Reading + Antenna Factor + Cable Loss – Pre-amplifier,  
Margin= Emission Level - Limit
- If peak below the average limit, the average emission was no test.
- The amplitude of spurious emissions which are attenuated by more than 20dB below the permissible value has no need to be reported.
- The worst case is Antenna A.

**MIMO**
**802.11n(20MHz)**

Polar (H/V)	Frequency	Meter Reading	Pre-amplifier	Cable Loss	Antenna Factor	Emission Level	Limits	Margin	Detector Type
	(MHz)	(dBuV)	(dB)	(dB)	(dB)	(dBuV/m)	(dBuV/m)	(dB)	
Low Channel:2412MHz									
V	4824.00	52.49	39.55	7.85	25.66	46.45	74.00	-27.55	PK
V	4824.00	47.88	39.55	7.85	25.66	41.84	54.00	-12.16	AV
V	7236.00	53.24	38.33	7.52	24.55	46.98	74.00	-27.02	PK
V	7236.00	46.39	38.33	7.52	24.55	40.13	54.00	-13.87	AV
H	4824.00	52.81	39.55	7.85	25.66	46.77	74.00	-27.23	PK
H	4824.00	44.99	39.55	7.85	25.66	38.95	54.00	-15.05	AV
H	7236.00	52.48	38.33	7.52	24.55	46.22	74.00	-27.78	PK
H	7236.00	44.78	38.33	7.52	24.55	38.52	54.00	-15.48	AV

Polar (H/V)	Frequency	Meter Reading	Pre-amplifier	Cable Loss	Antenna Factor	Emission Level	Limits	Margin	Detector Type
	(MHz)	(dBuV)	(dB)	(dB)	(dB)	(dBuV/m)	(dBuV/m)	(dB)	
Middle Channel:2437MHz									
V	4874.00	52.50	38.89	7.57	25.45	46.63	74.00	-27.37	PK
V	4874.00	47.18	38.89	7.57	25.45	41.31	54.00	-12.69	AV
V	7311.00	52.32	38.78	7.35	24.54	45.43	74.00	-28.57	PK
V	7311.00	44.94	38.78	7.35	24.54	38.05	54.00	-15.95	AV
H	4874.00	50.91	38.89	7.57	25.45	45.04	74.00	-28.96	PK
H	4874.00	43.20	38.89	7.57	25.45	37.33	54.00	-16.67	AV
H	7311.00	51.84	38.78	7.35	24.54	44.95	74.00	-29.05	PK
H	7311.00	44.05	38.78	7.35	24.54	37.16	54.00	-16.84	AV

Polar (H/V)	Frequency	Meter Reading	Pre-amplifier	Cable Loss	Antenna Factor	Emission Level	Limits	Margin	Detector Type
	(MHz)	(dBuV)	(dB)	(dB)	(dB)	(dBuV/m)	(dBuV/m)	(dB)	
High Channel: 2462MHz									
V	4924.00	51.66	38.75	7.46	25.41	45.78	74.00	-28.22	PK
V	4924.00	48.61	38.75	7.46	25.41	42.73	54.00	-11.27	AV
V	7386.00	50.66	38.65	7.22	24.52	43.75	74.00	-30.25	PK
V	7386.00	47.80	38.65	7.22	24.52	40.89	54.00	-13.11	AV
H	4924.00	50.55	38.75	7.46	25.41	44.67	74.00	-29.33	PK
H	4924.00	45.73	38.75	7.46	25.41	39.85	54.00	-14.15	AV
H	7386.00	51.09	38.65	7.22	24.52	44.18	74.00	-29.82	PK
H	7386.00	42.68	38.65	7.22	24.52	35.77	54.00	-18.23	AV

**Remark:**

1. Emission Level = Meter Reading + Antenna Factor + Cable Loss – Pre-amplifier,  
Margin= Emission Level - Limit
2. If peak below the average limit, the average emission was no test.
3. The amplitude of spurious emissions which are attenuated by more than 20dB below the permissible value has no need to be reported.
4. The worst case is Antenna A.

**802.11n(40MHz)**

Polar (H/V)	Frequency	Meter Reading	Pre-amplifier	Cable Loss	Antenna Factor	Emission Level	Limits	Margin	Detector Type
	(MHz)	(dBuV)	(dB)	(dB)	(dB)	(dBuV/m)	(dBuV/m)	(dB)	
Low Channel:2422MHz									
V	4844.00	52.43	39.55	7.77	25.66	46.31	74.00	-27.69	PK
V	4844.00	48.35	39.55	7.77	25.66	42.23	54.00	-11.77	AV
V	7266.00	52.36	38.33	7.30	24.55	45.88	74.00	-28.12	PK
V	7266.00	47.65	38.33	7.30	24.55	41.17	54.00	-12.83	AV
H	4844.00	50.43	39.55	7.77	25.66	44.31	74.00	-29.69	PK
H	4844.00	44.92	39.55	7.77	25.66	38.80	54.00	-15.20	AV
H	7266.00	52.98	38.33	7.30	24.55	46.50	74.00	-27.50	PK
H	7266.00	42.44	38.33	7.30	24.55	35.96	54.00	-18.04	AV

Polar (H/V)	Frequency	Meter Reading	Pre-amplifier	Cable Loss	Antenna Factor	Emission Level	Limits	Margin	Detector Type
	(MHz)	(dBuV)	(dB)	(dB)	(dB)	(dBuV/m)	(dBuV/m)	(dB)	
Middle Channel:2437MHz									
V	4874.00	53.64	38.89	7.57	25.45	47.77	74.00	-26.23	PK
V	4874.00	49.64	38.89	7.57	25.45	43.77	54.00	-10.23	AV
V	7311.00	52.62	38.78	7.35	24.54	45.73	74.00	-28.27	PK
V	7311.00	47.30	38.78	7.35	24.54	40.41	54.00	-13.59	AV
H	4874.00	54.17	38.89	7.57	25.45	48.30	74.00	-25.70	PK
H	4874.00	45.26	38.89	7.57	25.45	39.39	54.00	-14.61	AV
H	7311.00	52.11	38.78	7.35	24.54	45.22	74.00	-28.78	PK
H	7311.00	45.21	38.78	7.35	24.54	38.32	54.00	-15.68	AV

Polar (H/V)	Frequency	Meter Reading	Pre-amplifier	Cable Loss	Antenna Factor	Emission Level	Limits	Margin	Detector Type
	(MHz)	(dBuV)	(dB)	(dB)	(dB)	(dBuV/m)	(dBuV/m)	(dB)	
High Channel: 2452MHz									
V	4904.00	54.42	38.75	7.38	25.41	48.46	74.00	-25.54	PK
V	4904.00	48.82	38.75	7.38	25.41	42.86	54.00	-11.14	AV
V	7356.00	55.12	38.65	7.15	24.52	48.14	74.00	-25.86	PK
V	7356.00	47.94	38.65	7.15	24.52	40.96	54.00	-13.04	AV
H	4904.00	53.49	38.75	7.38	25.41	47.53	74.00	-26.47	PK
H	4904.00	46.27	38.75	7.38	25.41	40.31	54.00	-13.69	AV
H	7356.00	53.92	38.65	7.15	24.52	46.94	74.00	-27.06	PK
H	7356.00	44.50	38.65	7.15	24.52	37.52	54.00	-16.48	AV

Remark:

- Emission Level = Meter Reading + Antenna Factor + Cable Loss – Pre-amplifier,  
Margin= Emission Level - Limit
- If peak below the average limit, the average emission was no test.
- The amplitude of spurious emissions which are attenuated by more than 20dB below the permissible value has no need to be reported.
- The worst case is Antenna A.

### 3.3 RADIATED BAND EMISSION MEASUREMENT

#### 3.3.1 TEST REQUIREMENT:

FCC Part15 C Section 15.209 and 15.205

(a) Except as shown in paragraph (d) of this section, only spurious emissions are permitted in any of the frequency bands listed below:

MHz	MHz	MHz	GHz
0.090-0.110	16.42-16.423	399.9-410	4.5-5.15
0.495-0.505	16.69475-16.69525	608-614	5.35-5.46
2.1735-2.1905	16.80425-16.80475	960-1240	7.25-7.75
4.125-4.128	25.5-25.67	1300-1427	8.025-8.5
4.17725-4.17775	37.5-38.25	1435-1626.5	9.0-9.2
4.20725-4.20775	73-74.6	1645.5-1646.5	9.3-9.5
6.215-6.218	74.8-75.2	1660-1710	10.6-12.7
6.26775-6.26825	108-121.94	1718.8-1722.2	13.25-13.4
6.31175-6.31225	123-138	2200-2300	14.47-14.5
8.291-8.294	149.9-150.05	2310-2390	15.35-16.2
8.362-8.366	156.52475-156.52525	2483.5-2500	17.7-21.4
8.37625-8.38675	156.7-156.9	2690-2900	22.01-23.12
8.41425-8.41475	162.0125-167.17	3260-3267	23.6-24.0
12.29-12.293	167.72-173.2	3332-3339	31.2-31.8
12.51975-12.52025	240-285	3345.8-3358	36.43-36.5
12.57675-12.57725	322-335.4	3600-4400	( <sup>2</sup> )
13.36-13.41			

#### LIMITS OF RADIATED EMISSION MEASUREMENT (Above 1000MHz)

FREQUENCY (MHz)	Class B (dBuV/m) (at 3M)	
	PEAK	AVERAGE
Above 1000	74	54

Notes:

- (1) The limit for radiated test was performed according to FCC PART 15C.
- (2) The tighter limit applies at the band edges.
- (3) Emission level (dBuV/m)=20log Emission level (uV/m).

Spectrum Parameter	Setting
Attenuation	Auto
Start Frequency	2300MHz
Stop Frequency	2520
RB / VB (emission in restricted band)	1 MHz / 1 MHz for Peak, 1 MHz / 10Hz for Average

#### 3.3.2 TEST PROCEDURE

Above 1GHz test procedure as below:

- a. 1. The EUT was placed on the top of a rotating table 1.5 meters above the ground at a 3 meter camber. The table was rotated 360 degrees to determine the position of the highest radiation.
- b. The EUT was set 3 meters away from the interference-receiving antenna, which was mounted on the top of a variable-height antenna tower.
- c. The antenna height is varied from one meter to four meters above the ground to determine the maximum value of the field strength. Both horizontal and vertical polarizations of the antenna are set to make the measurement.

- d. For each suspected emission, the EUT was arranged to its worst case and then the antenna was tuned to heights from 1 meter to 4 meters and the rota table was turned from 0 degrees to 360 degrees to find the maximum reading.
- e. The test-receiver system was set to Peak Detect Function and Specified Bandwidth with Maximum Hold Mode.
- f. If the emission level of the EUT in peak mode was 10dB lower than the limit specified, then testing could be stopped and the peak values of the EUT would be reported. Otherwise the emissions that did not have 10dB margin would be re-tested one by one using peak, quasi-peak or average method as specified and then reported in a data sheet.
- g. Test the EUT in the lowest channel, the Highest channel

Note:

Both horizontal and vertical antenna polarities were tested and performed pretest to three orthogonal axis. The worst case emissions were reported

### 3.3.3 DEVIATION FROM TEST STANDARD

No deviation

### 3.3.4 TEST SETUP

Radiated Emission Test-Up Frequency Above 1GHz

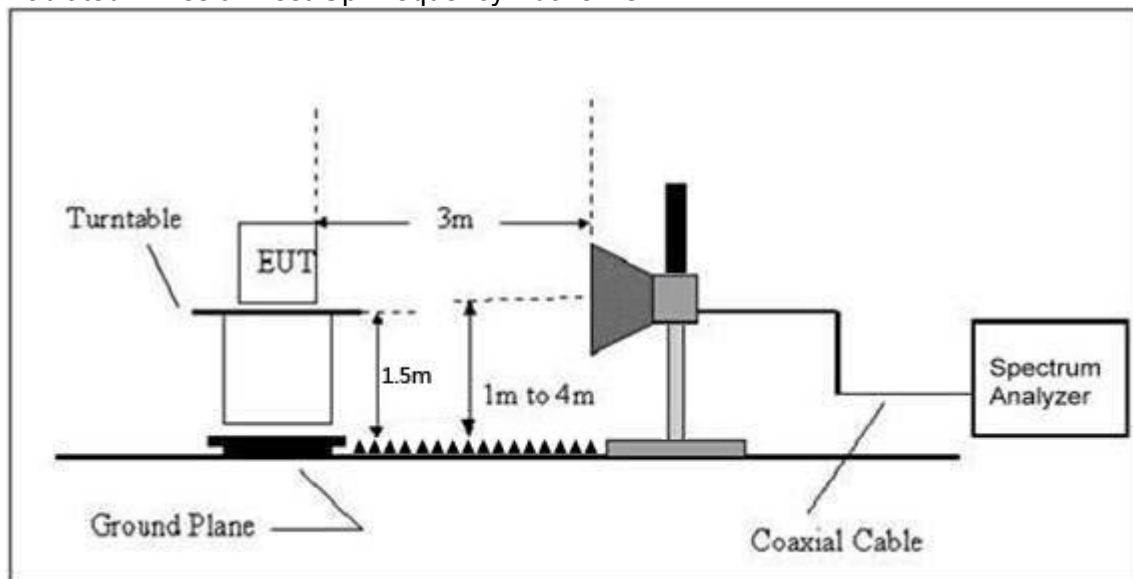

### 3.3.5 EUT OPERATING CONDITIONS

The EUT tested system was configured as the statements of 2.3 Unless otherwise a special operating condition is specified in the follows during the testing.

### 3.3.6 TEST RESULT

	Polar (H/V)	Frequency (MHz)	Meter Reading (dBuV)	Pre-amplifier (dB)	Cable Loss (dB)	Antenna Factor (dB/m)	Emission level (dBuV/m)	Limits (dBuV/m)		Result
							PK	PK	AV	
802.11b	<b>Low Channel 2412MHz</b>									
	H	2390.00	59.79	38.06	7.42	20.15	49.30	74.00	54.00	PASS
	H	2400.00	57.85	38.06	7.42	20.15	47.36	74.00	54.00	PASS
	V	2390.00	60.41	38.06	7.42	20.15	49.92	74.00	54.00	PASS
	V	2400.00	59.86	38.06	7.42	20.15	49.37	74.00	54.00	PASS
	<b>High Channel 2462MHz</b>									
	H	2483.50	61.64	38.17	7.45	20.54	51.46	74.00	54.00	PASS
	H	2500.00	60.10	38.17	7.45	20.54	49.92	74.00	54.00	PASS
	V	2483.50	62.04	38.20	7.45	20.54	51.83	74.00	54.00	PASS
	V	2500.00	59.91	38.20	7.45	20.54	49.70	74.00	54.00	PASS
802.11g	<b>Low Channel 2412MHz</b>									
	H	2390.00	60.15	38.06	7.42	20.15	49.66	74.00	54.00	PASS
	H	2400.00	59.44	38.06	7.42	20.15	48.95	74.00	54.00	PASS
	V	2390.00	58.42	38.06	7.42	20.15	47.93	74.00	54.00	PASS
	V	2400.00	58.56	38.06	7.42	20.15	48.07	74.00	54.00	PASS
	<b>High Channel 2462MHz</b>									
	H	2483.50	60.84	38.17	7.45	20.54	50.66	74.00	54.00	PASS
	H	2500.00	60.98	38.17	7.45	20.54	50.80	74.00	54.00	PASS
	V	2483.50	61.93	38.20	7.45	20.54	51.72	74.00	54.00	PASS
	V	2500.00	60.54	38.20	7.45	20.54	50.33	74.00	54.00	PASS
802.11n20	<b>Low Channel 2412MHz</b>									
	H	2390.00	60.95	38.06	7.42	20.15	50.46	74.00	54.00	PASS
	H	2400.00	60.03	38.06	7.42	20.15	49.54	74.00	54.00	PASS
	V	2390.00	60.30	38.06	7.42	20.15	49.81	74.00	54.00	PASS
	V	2400.00	57.04	38.06	7.42	20.15	46.55	74.00	54.00	PASS
	<b>High Channel 2462MHz</b>									
	H	2483.50	60.56	38.06	7.42	20.15	50.07	74.00	54.00	PASS
	H	2500.00	59.33	38.06	7.42	20.15	48.84	74.00	54.00	PASS
	V	2483.50	59.99	38.06	7.42	20.15	49.50	74.00	54.00	PASS
	V	2500.00	62.07	38.06	7.42	20.15	51.58	74.00	54.00	PASS
802.11n40	<b>Low Channel 2422MHz</b>									
	H	2390.00	59.37	38.17	7.45	20.54	49.19	74.00	54.00	PASS
	H	2400.00	60.29	38.17	7.45	20.54	50.11	74.00	54.00	PASS
	V	2390.00	61.64	38.20	7.45	20.54	51.43	74.00	54.00	PASS
	V	2400.00	61.27	38.20	7.45	20.54	51.06	74.00	54.00	PASS
	<b>High Channel 2452MHz</b>									
	H	2483.50	59.86	38.06	7.42	20.15	49.37	74.00	54.00	PASS
	H	2500.00	62.29	38.06	7.42	20.15	51.80	74.00	54.00	PASS
	V	2483.50	60.18	38.06	7.42	20.15	49.69	74.00	54.00	PASS
	V	2500.00	61.66	38.06	7.42	20.15	51.17	74.00	54.00	PASS

**Remark:**

- Emission Level = Meter Reading + Antenna Factor + Cable Loss – Pre-amplifier, Margin= Emission Level - Limit
- If the PK measured levels comply with average limit, then the average level were deemed to comply with average limit.

## MIMO

	Polar (H/V)	Frequency (MHz)	Meter Reading (dBuV)	Pre-amplifier (dB)	Cable Loss (dB)	Antenna Factor (dB/m)	Emission level (dBuV/m)	Limits (dBuV/m)		Result
							PK	PK	AV	
802.11n20	<b>Low Channel 2412MHz</b>									
	H	2390.00	59.07	38.06	7.42	20.15	48.58	74.00	54.00	PASS
	H	2400.00	60.33	38.06	7.42	20.15	49.84	74.00	54.00	PASS
	V	2390.00	61.00	38.06	7.42	20.15	50.51	74.00	54.00	PASS
	V	2400.00	59.61	38.06	7.42	20.15	49.12	74.00	54.00	PASS
	<b>High Channel 2462MHz</b>									
	H	2483.50	60.46	38.17	7.45	20.54	50.28	74.00	54.00	PASS
	H	2500.00	59.32	38.17	7.45	20.54	49.14	74.00	54.00	PASS
	V	2483.50	59.47	38.2	7.45	20.54	49.26	74.00	54.00	PASS
	V	2500.00	58.66	38.2	7.45	20.54	48.45	74.00	54.00	PASS
802.11n40	<b>Low Channel 2422MHz</b>									
	H	2390.00	57.78	38.06	7.42	20.15	47.29	74.00	54.00	PASS
	H	2400.00	58.88	38.06	7.42	20.15	48.39	74.00	54.00	PASS
	V	2390.00	59.17	38.06	7.42	20.15	48.68	74.00	54.00	PASS
	V	2400.00	61.09	38.06	7.42	20.15	50.60	74.00	54.00	PASS
	<b>High Channel 2452MHz</b>									
	H	2483.50	60.95	38.17	7.45	20.54	50.77	74.00	54.00	PASS
	H	2500.00	59.87	38.17	7.45	20.54	49.69	74.00	54.00	PASS
	V	2483.50	58.16	38.2	7.45	20.54	47.95	74.00	54.00	PASS
	V	2500.00	60.34	38.2	7.45	20.54	50.13	74.00	54.00	PASS
<b>Remark:</b>										
1. Emission Level = Meter Reading + Antenna Factor + Cable Loss – Pre-amplifier, Margin= Emission Level - Limit										
2. If the PK measured levels comply with average limit, then the average level were deemed to comply with average limit.										



## 4. POWER SPECTRAL DENSITY TEST

### 4.1 APPLIED PROCEDURES / LIMIT

FCC Part15 (15.247) , Subpart C				
Section	Test Item	Limit	Frequency Range (MHz)	Result
15.247	Power Spectral Density	8 dBm (in any 3KHz)	2400-2483.5	PASS

#### 4.1.1 TEST PROCEDURE

1. Set analyzer center frequency to DTS channel center frequency.
2. Set the span to 1.5 times the DTS bandwidth.
3. Set the RBW to:  $3 \text{ kHz} \leq \text{RBW} \leq 100 \text{ kHz}$ .
4. Set the VBW  $\geq 3 \times \text{RBW}$ .
5. Detector = peak.
6. Sweep time = auto couple.
7. Trace mode = max hold.
8. Allow trace to fully stabilize.
9. Use the peak marker function to determine the maximum amplitude level within the RBW.
10. If measured value exceeds limit, reduce RBW (no less than 3 kHz) and repeat.

#### 4.1.2 DEVIATION FROM STANDARD

No deviation.

#### 4.1.3 TEST SETUP



#### 4.1.4 EUT OPERATION CONDITIONS

The EUT tested system was configured as the statements of 2.1 Unless otherwise a special operating condition is specified in the follows during the testing.

Note: Power Spectral Density(dBm)=Reading+Cable Loss



### 4.1.5 TEST RESULTS

Temperature :	26 °C	Relative Humidity :	54%
Pressure :	101kPa	Test Voltage :	AC120V/60Hz
Test Mode :	TX b Mode		

Frequency	Power Spectral Density (dBm/3KHz) ANTA	Power Spectral Density (dBm/3KHz) ANTB	Total power density (dBm/3KHz)	Limit (dBm/3KHz)	Result
2412 MHz	-0.341	-8.550	/	8	PASS
2437 MHz	0.328	-0.186	/	8	PASS
2462 MHz	-0.595	-10.153	/	8	PASS

Note: A(B) Represent the value of antenna A and B, The worst data is Antenna A, only shown Antenna A Plot.

#### TX CH01



**TX CH06**



**TX CH11**

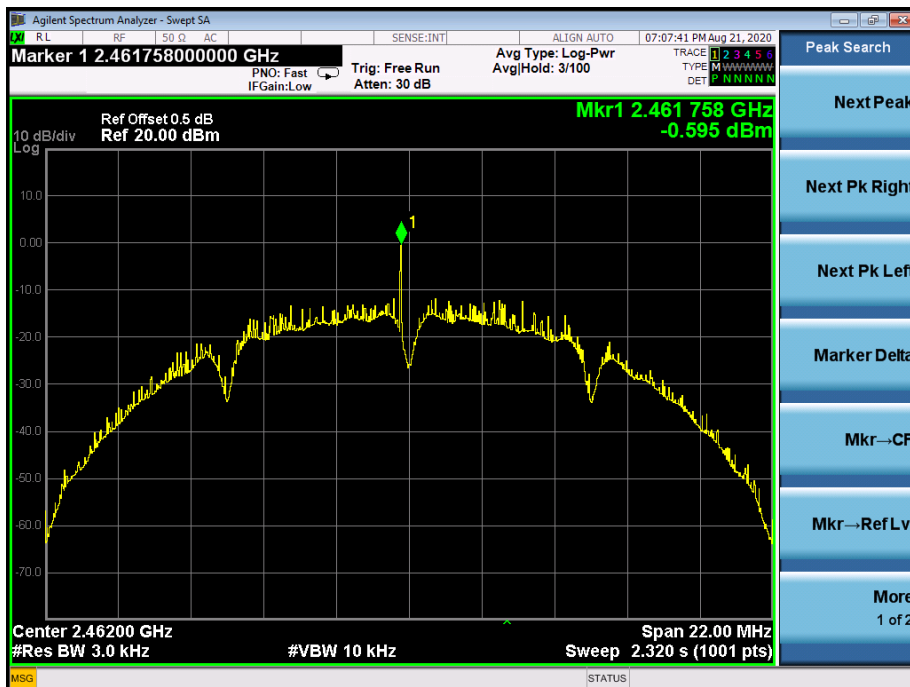

Temperature :	26 °C	Relative Humidity :	54%
Pressure :	101kPa	Test Voltage :	AC120V/60HZ
Test Mode :	TX g Mode		

Frequency	Power Spectral Density (dBm/3KHz) ANTA	Power Spectral Density (dBm/3KHz) ANTB	Total power density (dBm/3KHz)	Limit (dBm/3KHz)	Result
2412 MHz	-15.590	-15.923	/	8	PASS
2437 MHz	-16.249	-16.857	/	8	PASS
2462 MHz	-16.007	-15.907	/	8	PASS

Note: A(B) Represent the value of antenna A and B, The worst data is Antenna A, only shown Antenna A Plot.

### TX CH01

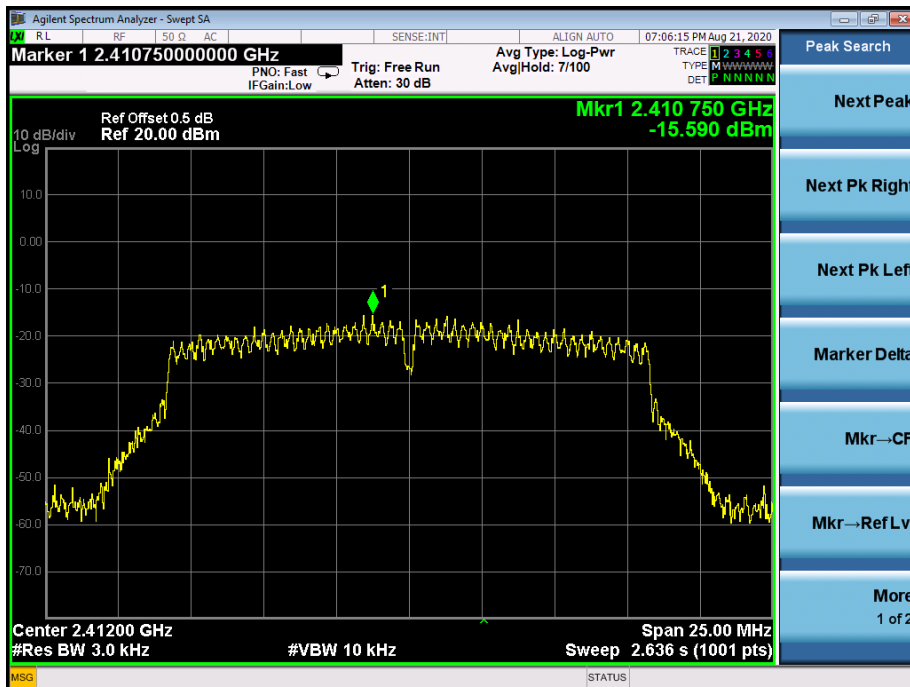

**TX CH06**

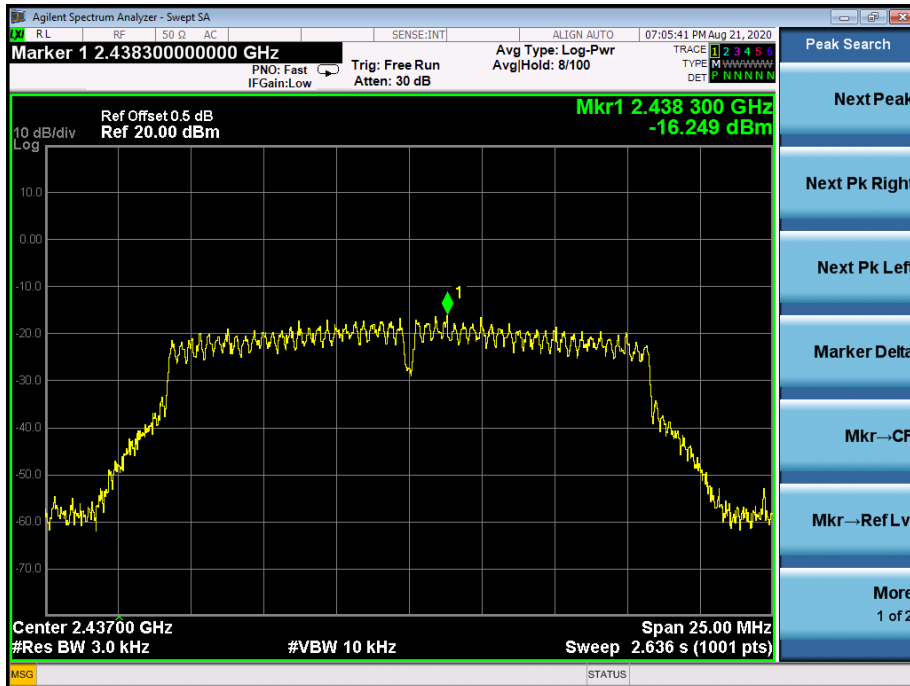

**TX CH11**

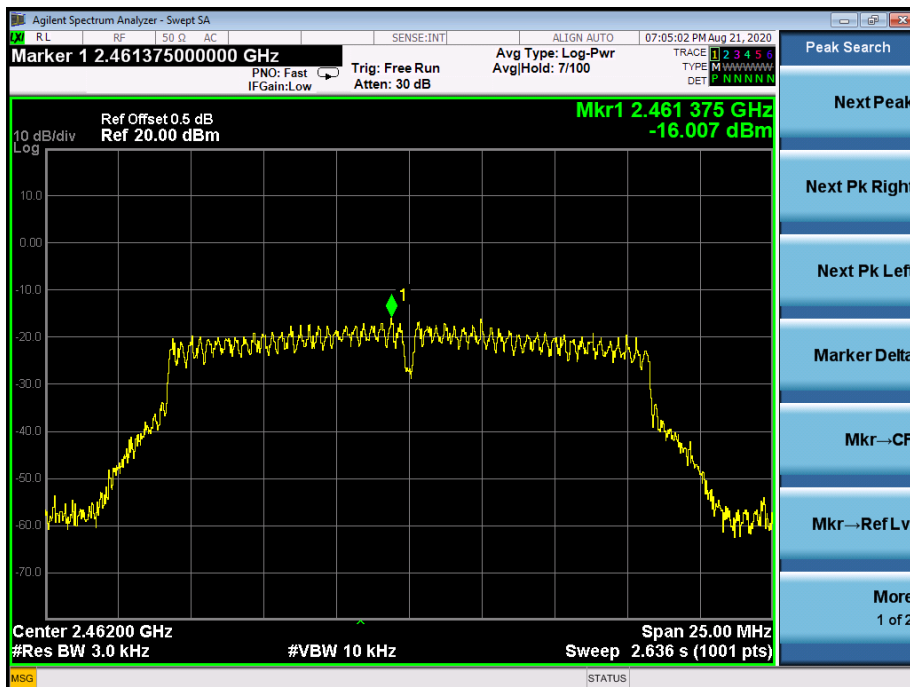

Temperature :	26 °C	Relative Humidity :	54%
Pressure :	101kPa	Test Voltage :	AC120V/60HZ
Test Mode :	TX n Mode(20M)		

Frequency	Power Spectral Density (dBm/3KHz) ANTA	Power Spectral Density (dBm/3KHz) ANTB	Total power density (dBm/3KHz)	Limit (dBm/3KHz)	Result
2412 MHz	-15.963	-15.591	-12.763	8	PASS
2437 MHz	-16.893	-16.809	-12.100	8	PASS
2462 MHz	-16.785	-16.372	-13.563	8	PASS

Note: A(B) Represent the value of antenna A and B, The worst data is Antenna B ,only shown Antenna B Plot.

### TX CH01

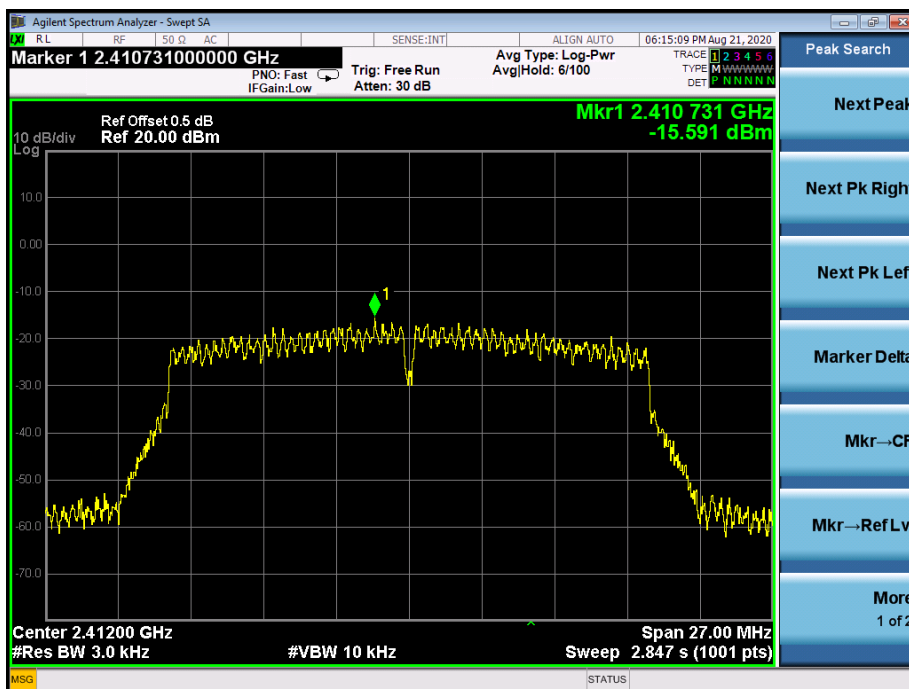

**TX CH06**

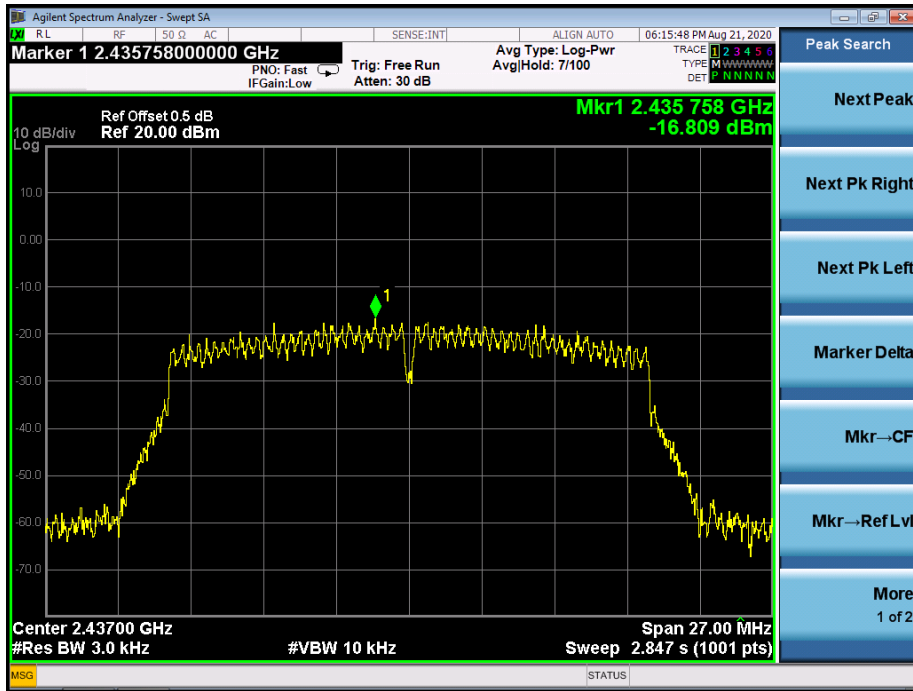

**TX CH11**

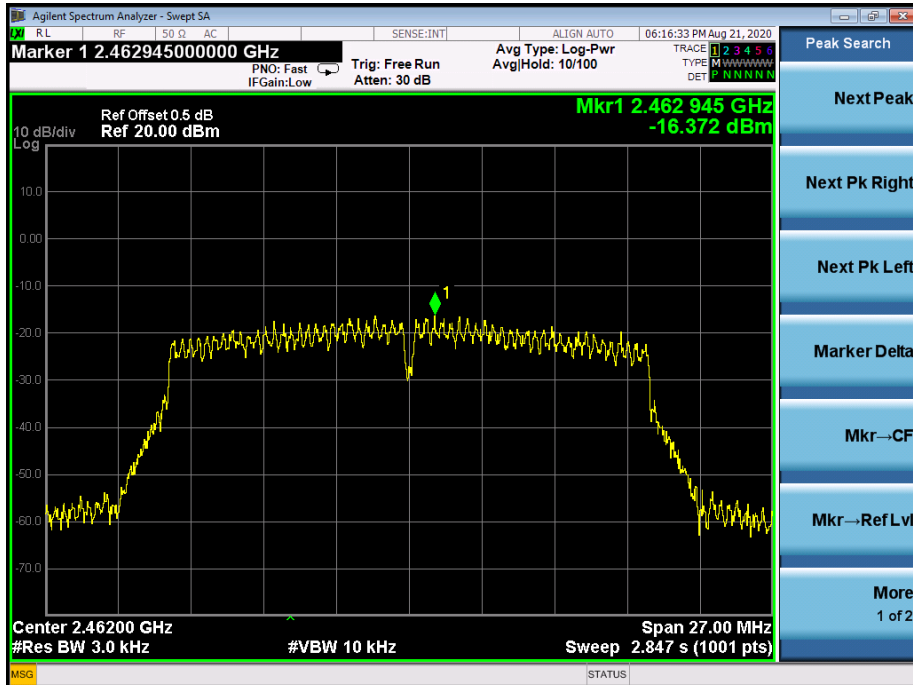

Temperature :	26 °C	Relative Humidity :	54%
Pressure :	101kPa	Test Voltage :	AC120V/60Hz
Test Mode :	TX n Mode(40M)		

Frequency	Power Spectral Density (dBm/3KHz) ANTA	Power Spectral Density (dBm/3KHz) ANTB	Total power density (dBm/3KHz)	Limit (dBm/3KHz)	Result
2422 MHz	-16.654	-17.283	-13.947	8	PASS
2437 MHz	-18.242	-17.730	-14.968	8	PASS
2452 MHz	-17.443	-17.525	-14.474	8	PASS

Note: A(B) Represent the value of antenna A and B, The worst data is Antenna A ,only shown Antenna A Plot.

### TX CH03

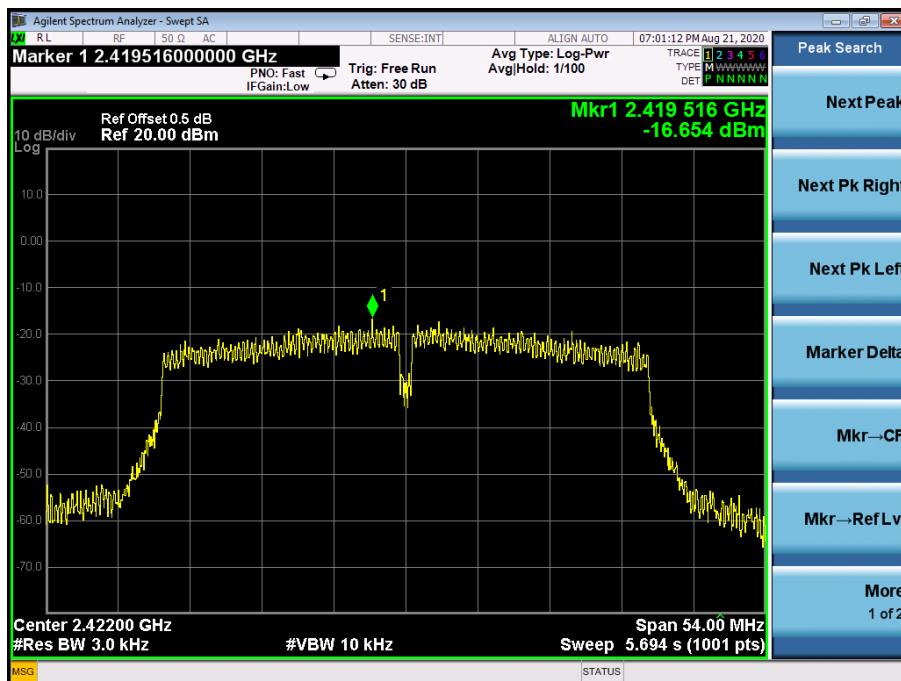

**TX CH06**

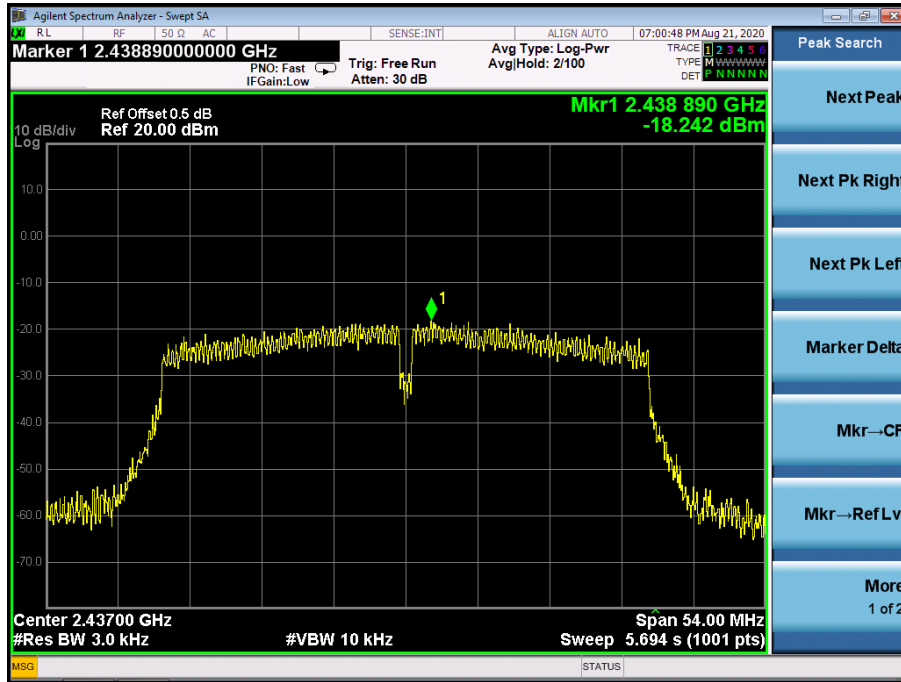

**TX CH09**

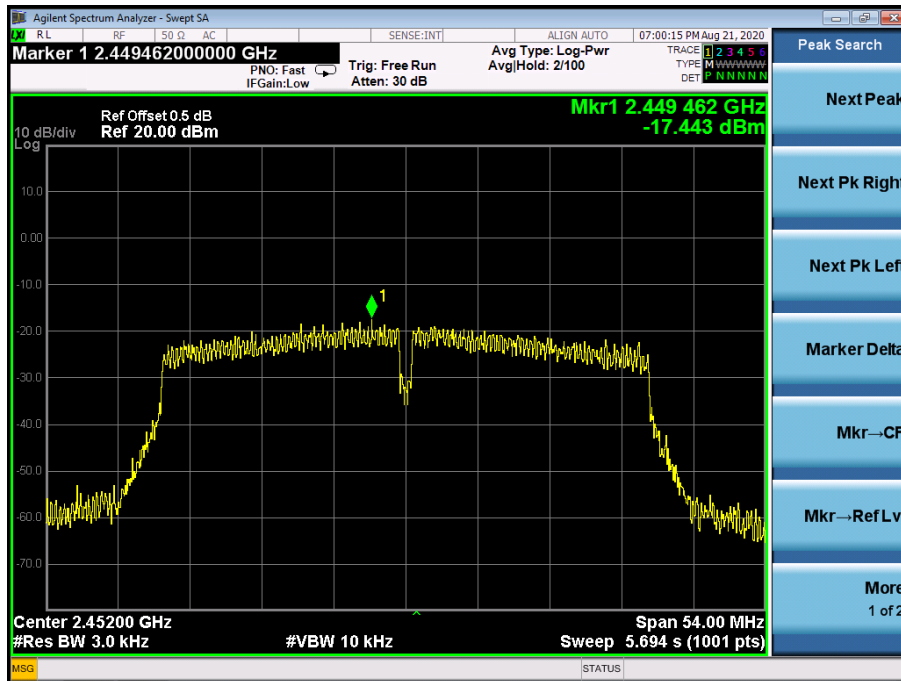



## 5. BANDWIDTH TEST

### 5.1 APPLIED PROCEDURES / LIMIT

FCC Part15 (15.247) , Subpart C				
Section	Test Item	Limit	Frequency Range (MHz)	Result
15.247(a)(2)	Bandwidth	$\geq 500\text{KHz}$ (6dB bandwidth)	2400-2483.5	PASS

#### 5.1.1 TEST PROCEDURE

1. Set RBW = 100 kHz.
2. Set the video bandwidth (VBW)  $\geq 3 \times$  RBW.
3. Detector = Peak.
4. Trace mode = max hold.
5. Sweep = auto couple.
6. Allow the trace to stabilize.
7. Measure the maximum width of the emission that is constrained by the frequencies associated with the two outermost amplitude points (upper and lower frequencies) that are attenuated by 6 dB relative to the maximum level measured in the fundamental emission.

#### 5.1.2 DEVIATION FROM STANDARD

No deviation.

#### 5.1.3 TEST SETUP

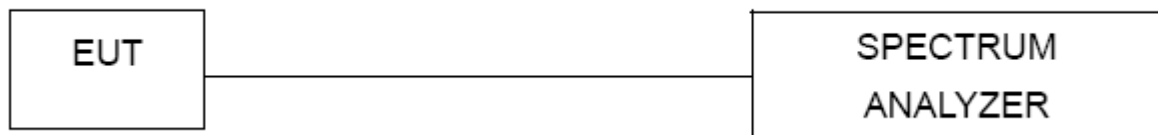

#### 5.1.4 EUT OPERATION CONDITIONS

The EUT tested system was configured as the statements of 2.4 Unless otherwise a special operating condition is specified in the follows during the testing.

### 5.1.5 TEST RESULTS

Temperature :	26 °C	Relative Humidity :	54%
Pressure :	101kPa	Test Voltage :	AC120V/60HZ
Test Mode :	TX b Mode		

Frequency (MHz)	6dB bandwidth (MHz) ANTA	6dB bandwidth (MHz) ANTB	Limit (kHz)	Result
2412	10.06	10.05	500	Pass
2437	9.11	10.03	500	Pass
2462	10.04	9.60	500	Pass

Note: A(B) Represent the value of antenna A and B, The worst data is Antenna A ,only shown Antenna A Plot.

#### TX CH 01

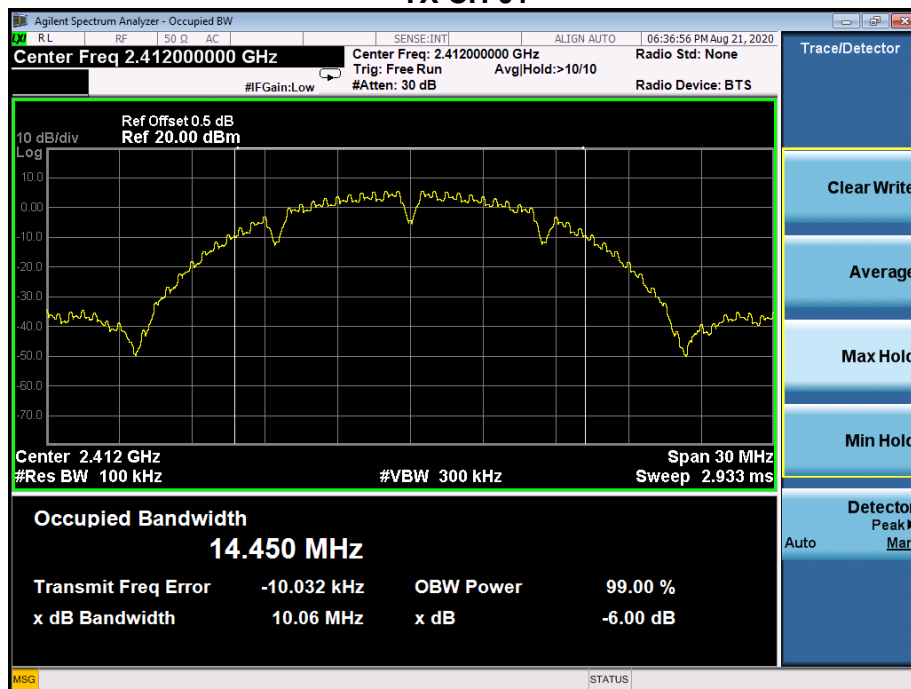

**TX CH 06**

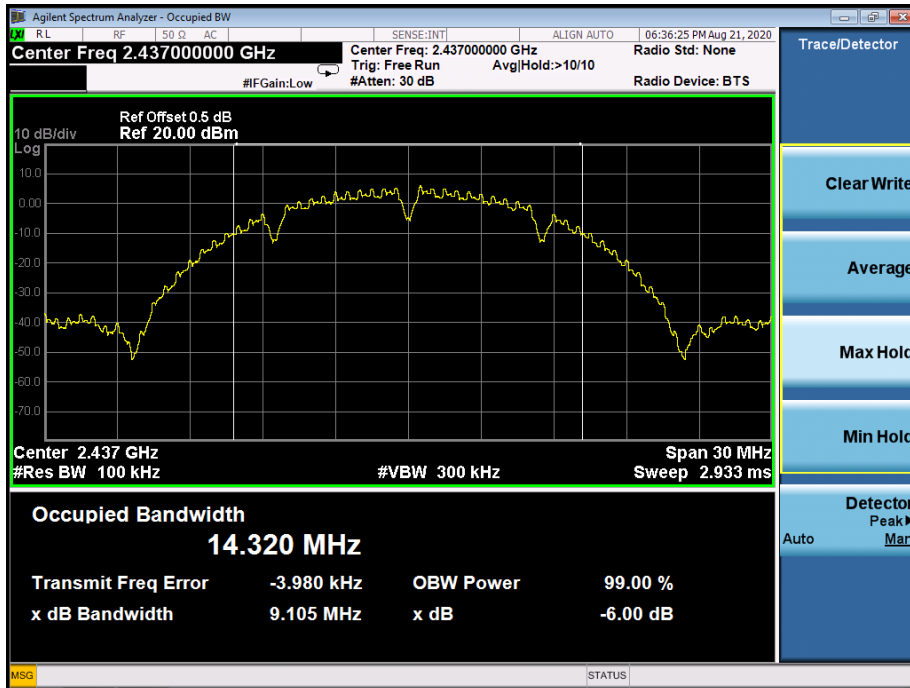

**TX CH 11**

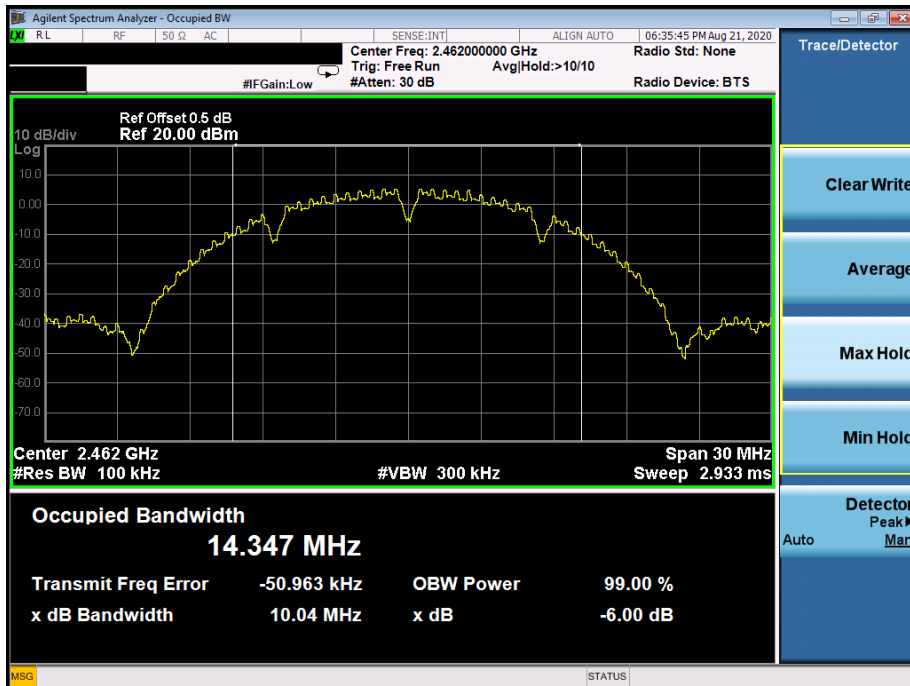

Temperature :	26 °C	Relative Humidity :	54%
Pressure :	101kPa	Test Voltage :	AC120V/60HZ
Test Mode :	TX g Mode		

Frequency (MHz)	6dB bandwidth (MHz) ANTA	6dB bandwidth (MHz) ANTB	Limit (kHz)	Result
2412	15.13	15.13	500	Pass
2437	15.12	15.13	500	Pass
2462	15.13	15.15	500	Pass

Note: A(B) Represent the value of antenna A and B, The worst data is Antenna B ,only shown Antenna B Plot.

### TX CH 01

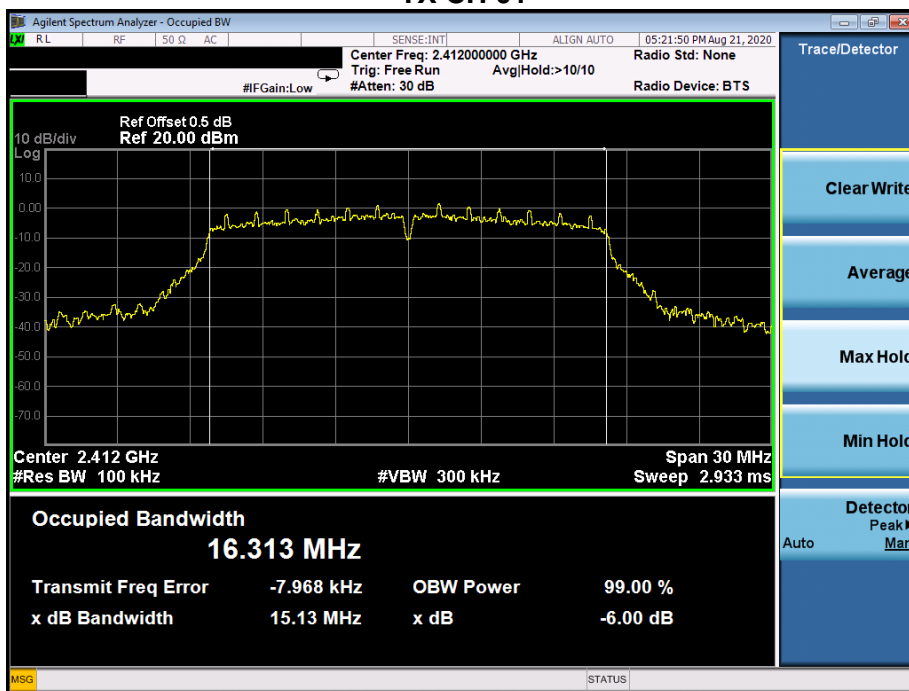

**TX CH 06**

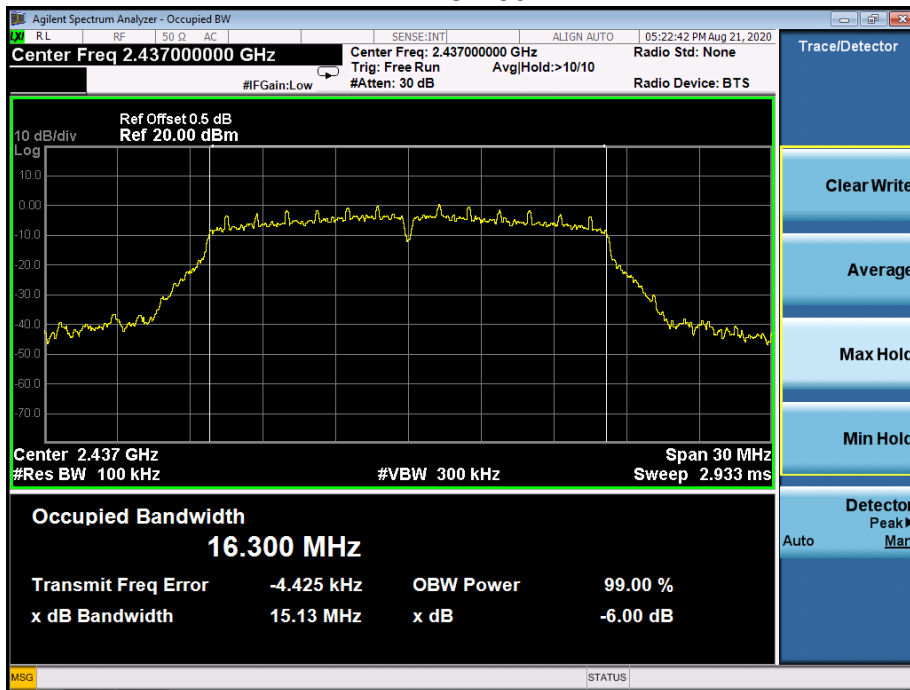

**TX CH 11**

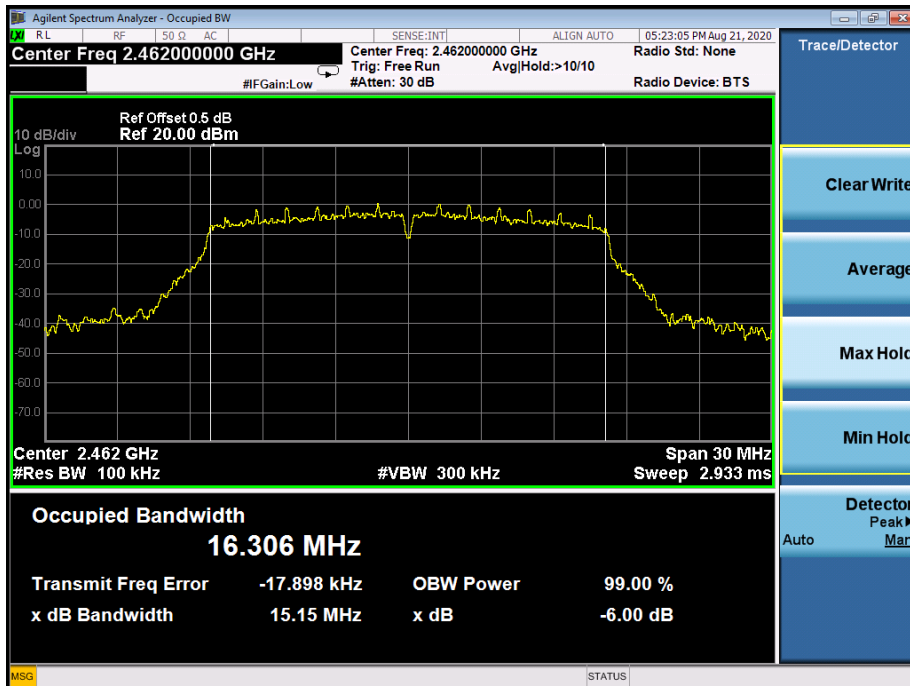

Temperature :	26 °C	Relative Humidity :	54%
Pressure :	101kPa	Test Voltage :	AC120V/60HZ
Test Mode :	TX n Mode(20M)		

Frequency (MHz)	6dB bandwidth (MHz) ANTA	6dB bandwidth (MHz) ANTB	Limit (kHz)	Result
2412	15.14	15.12	500	Pass
2437	15.13	15.14	500	Pass
2462	15.13	15.13	500	Pass

Note: A(B) Represent the value of antenna A and B, The worst data is Antenna A ,only shown Antenna A Plot.

### TX CH 01

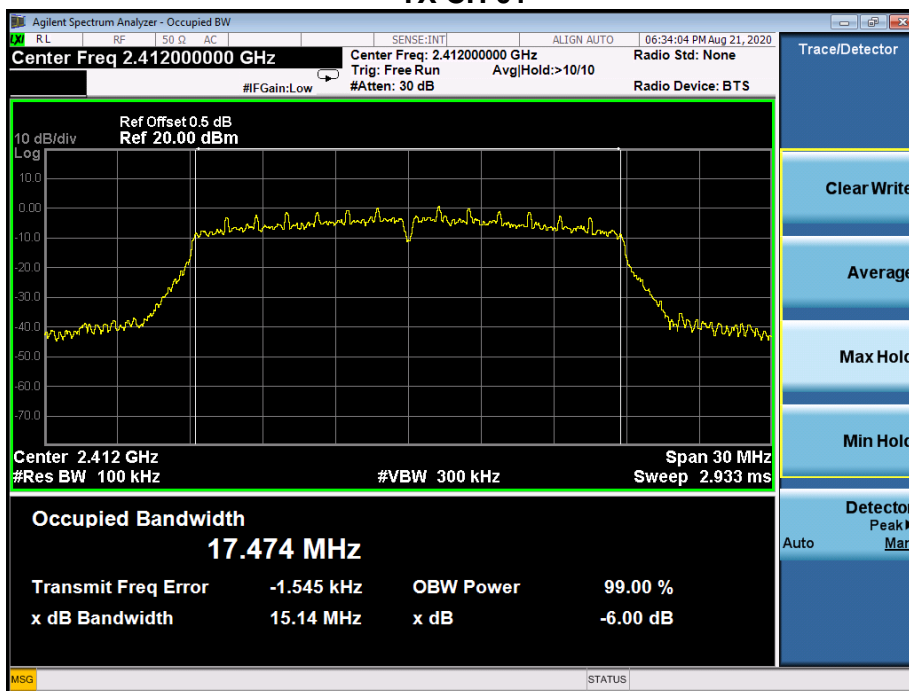

**TX CH 06**

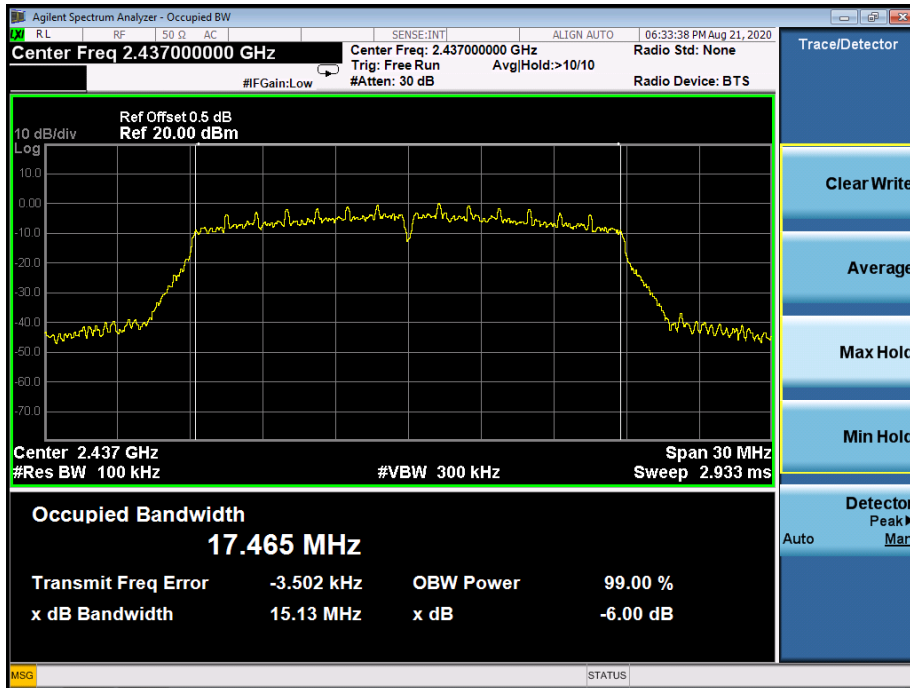

**TX CH 11**

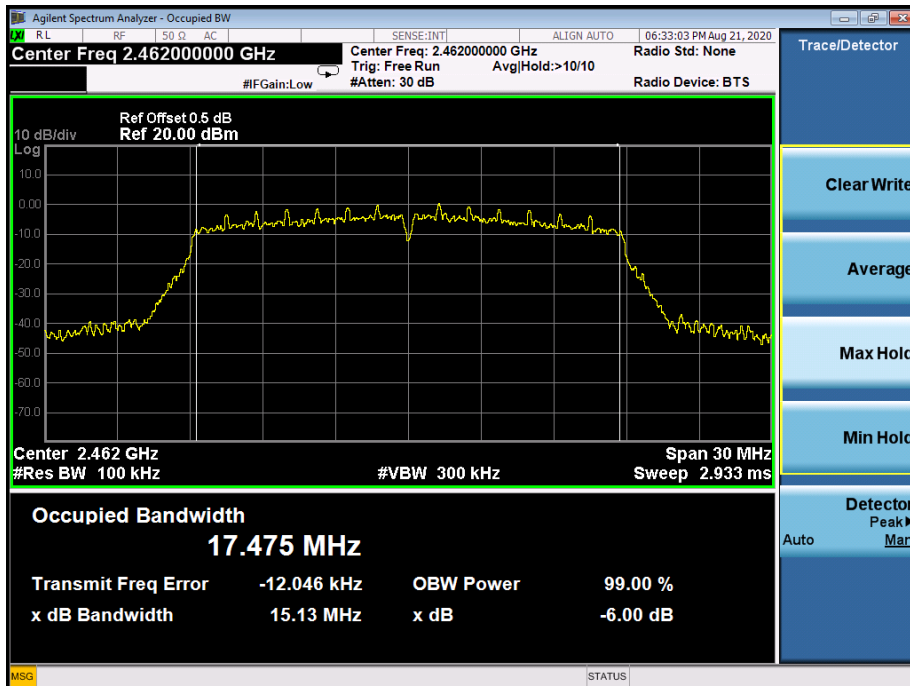

Temperature :	26 °C	Relative Humidity :	54%
Pressure :	101kPa	Test Voltage :	AC120V/60Hz
Test Mode :	TX n Mode(40M)		

Frequency (MHz)	6dB bandwidth (MHz) ANTA	6dB bandwidth (MHz) ANTB	Limit (kHz)	Result
2422	35.13	35.14	500	Pass
2437	35.12	35.10	500	Pass
2452	35.12	35.09	500	Pass

Note: A(B) Represent the value of antenna A and B, The worst data is Antenna B ,only shown Antenna B Plot.

### TX CH 03

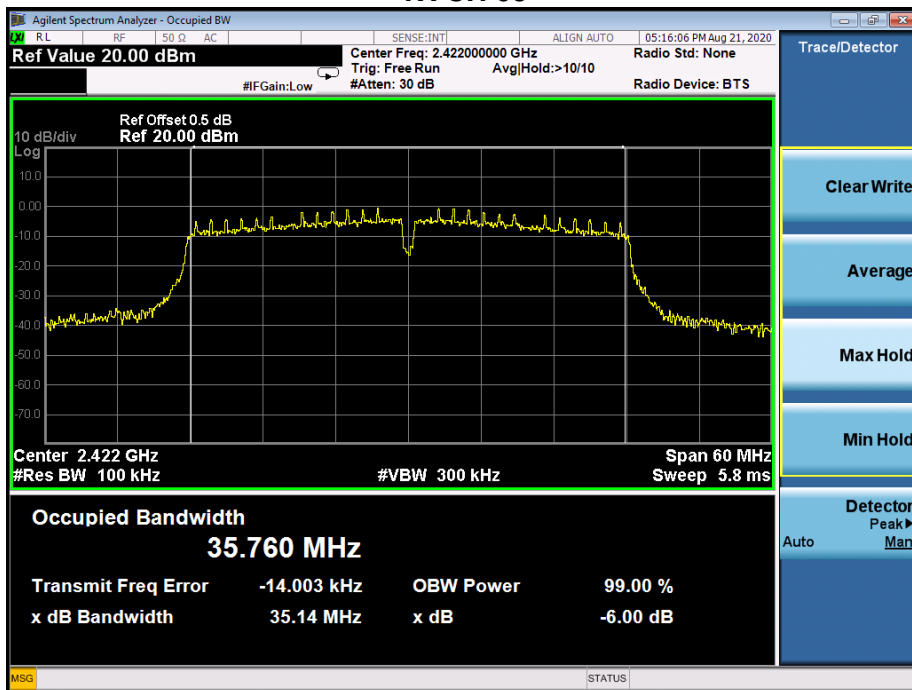



**TX CH 06**

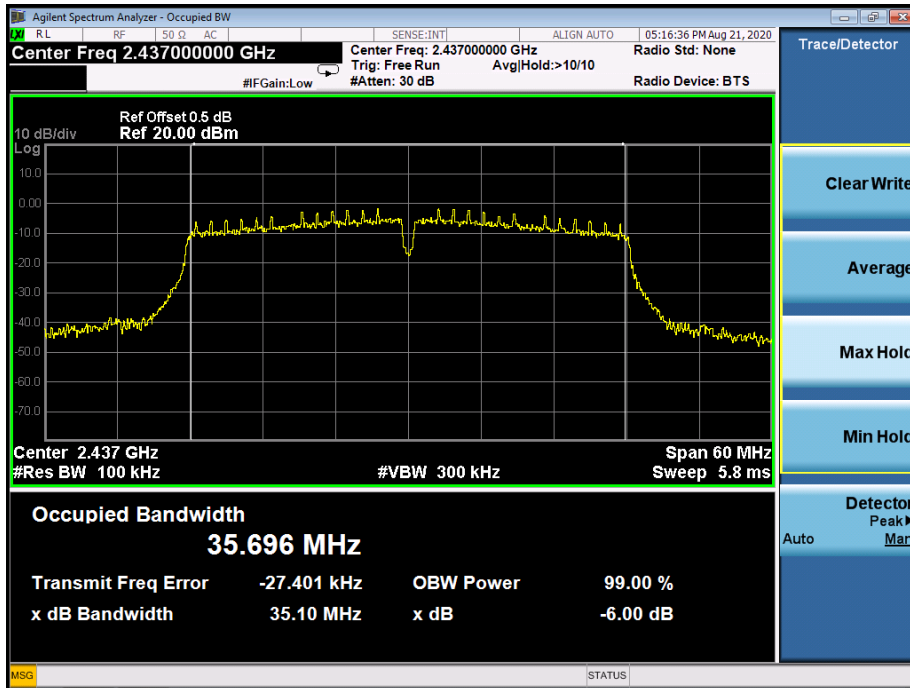

**TX CH 09**

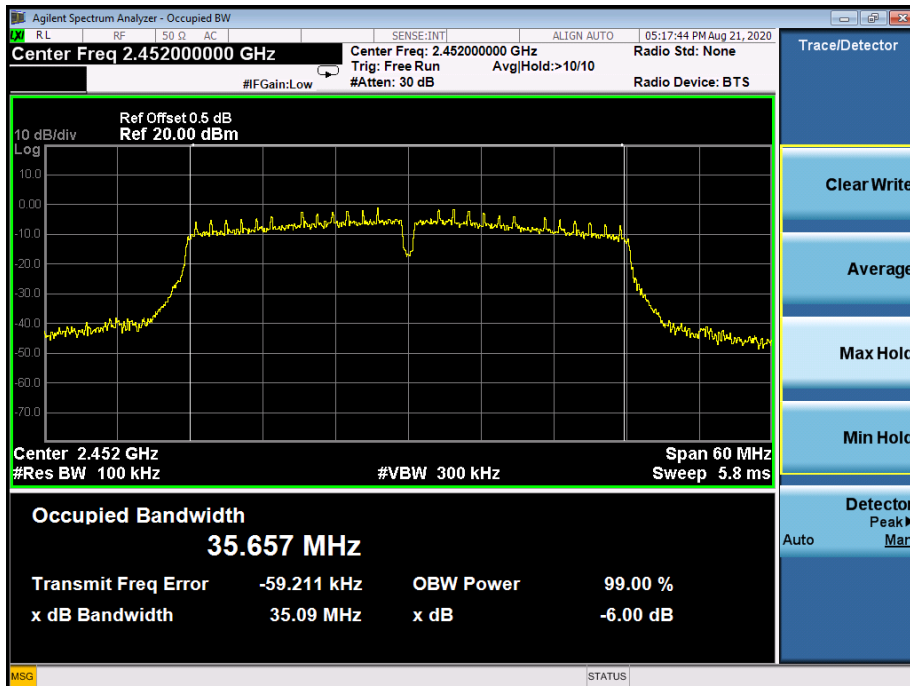

## 6. PEAK OUTPUT POWER TEST

### 6.1 APPLIED PROCEDURES/LIMIT

FCC Part15 (15.247) , Subpart C				
Section	Test Item	Limit	Frequency Range (MHz)	Result
15.247(b)(3)	Peak Output Power	1 watt or 30dBm	2400-2483.5	PASS

#### 6.1.1 TEST PROCEDURE

- a. The EUT was directly connected to the Power meter

#### 6.1.2 DEVIATION FROM STANDARD

No deviation.

#### 6.1.3 TEST SETUP



#### 6.1.4 EUT OPERATION CONDITIONS

The EUT tested system was configured as the statements of 2.4 Unless otherwise a special operating condition is specified in the follows during the testing.

### 6.1.5 TEST RESULTS

Temperature :	26 °C	Relative Humidity :	54%
Pressure :	101kPa	Test Voltage :	AC120V/60HZ

	Frequency	Maximum Conducted Output Power(PK) ANTA	Maximum Conducted Output Power(PK) ANTB	Total Power Conducted Output Power(PK)	LIMIT
	(MHz)	(dBm)	(dBm)	(dBm)	dBm
802.11b	2412	16.35	16.25	/	30
	2437	16.43	15.87	/	30
	2462	16.38	16.43	/	30
802.11g	2412	15.04	14.57	/	30
	2437	14.72	14.39	/	30
	2462	14.74	14.81	/	30
802.11n 20	2412	14.05	13.72	16.90	30
	2437	13.38	13.22	16.31	30
	2462	13.43	13.88	16.67	30
802.11n 40	2422	12.05	12.78	15.44	30
	2437	12.11	12.37	15.25	30
	2452	12.05	12.21	15.14	30

## 7. 100 KHZ BANDWIDTH OF FREQUENCY BAND EDGE

### 7.1 APPLICABLE STANDARD

in any 100 kHz bandwidth outside the frequency bands in which the spread spectrum intentional radiator is operating, the radio frequency power that is produced by the intentional radiator shall be at least 20dB below that in the 100kHz bandwidth within the band that contains the highest level of the desired power, In addition, radiated emissions which fall in the restricted bands, as defined in§15.205(a), must also comply with the radiated emission limits specified in15.209(a).

### 7.2 TEST PROCEDURE

Using the following spectrum analyzer setting:

- a) Set the RBW = 100KHz.
- b) Set the VBW = 300KHz.
- c) Sweep time = auto couple.
- d) Detector function = peak.
- e) Trace mode = max hold.
- f) Allow trace to fully stabilize.

### 7.3 DEVIATION FROM STANDARD

No deviation.

### 7.4 TEST SETUP



### 7.5 EUT OPERATION CONDITIONS

The EUT tested system was configured as the statements of 2.4 Unless otherwise a special operating condition is specified in the follows during the testing.

### 7.6 TEST RESULTS

Note: A(B) Represent the value of antenna A and B, The worst data is Antenna B ,only shown Antenna B Plot.

802.11b: Band Edge, Left Side

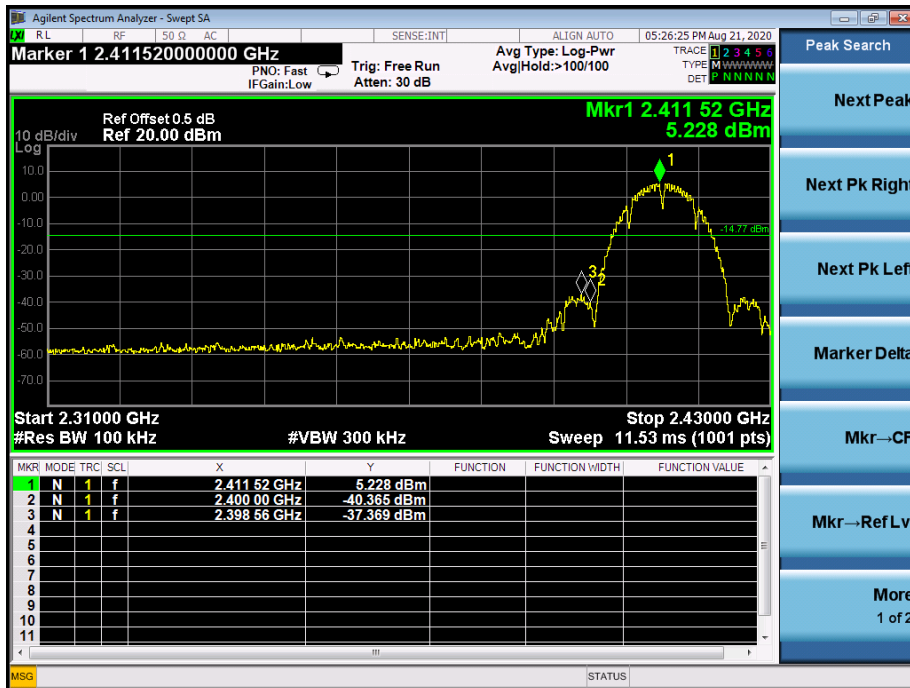

802.11b: Band Edge, Right Side

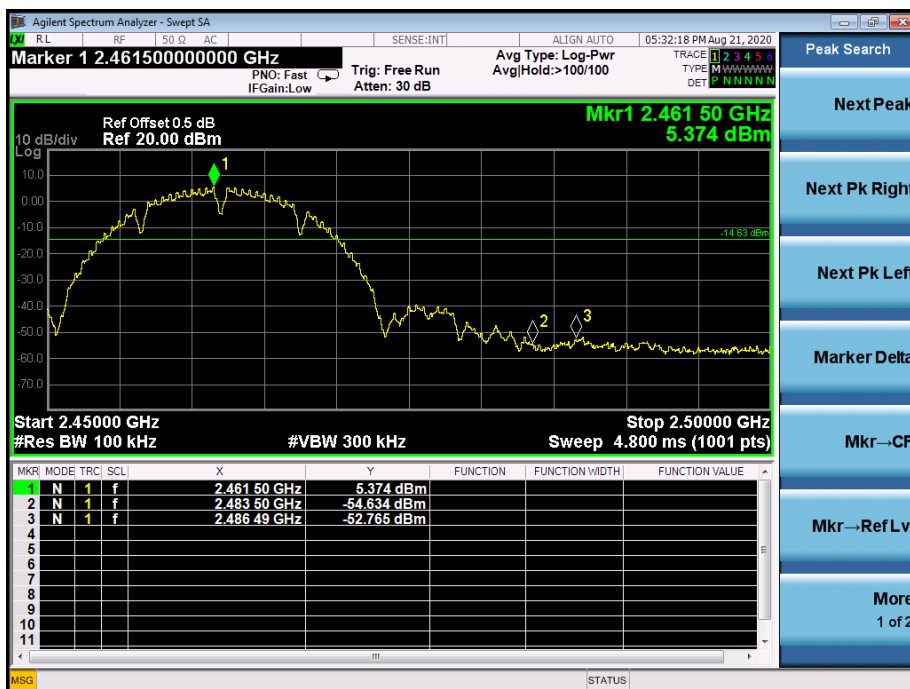

802.11g: Band Edge, Left Side

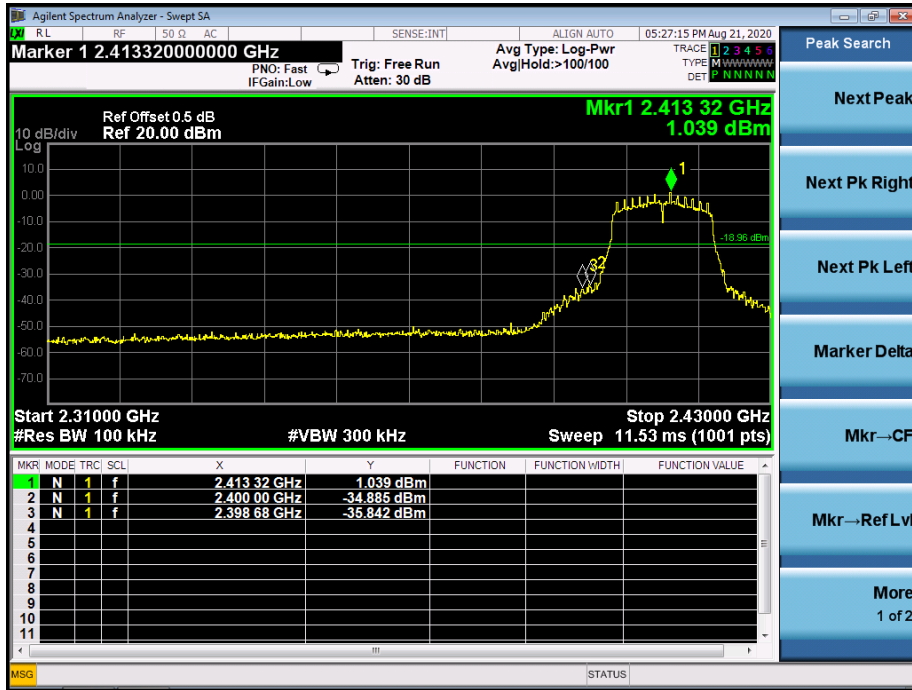

802.11g: Band Edge, Right Side



802.11n-HT20: Band Edge, Left Side

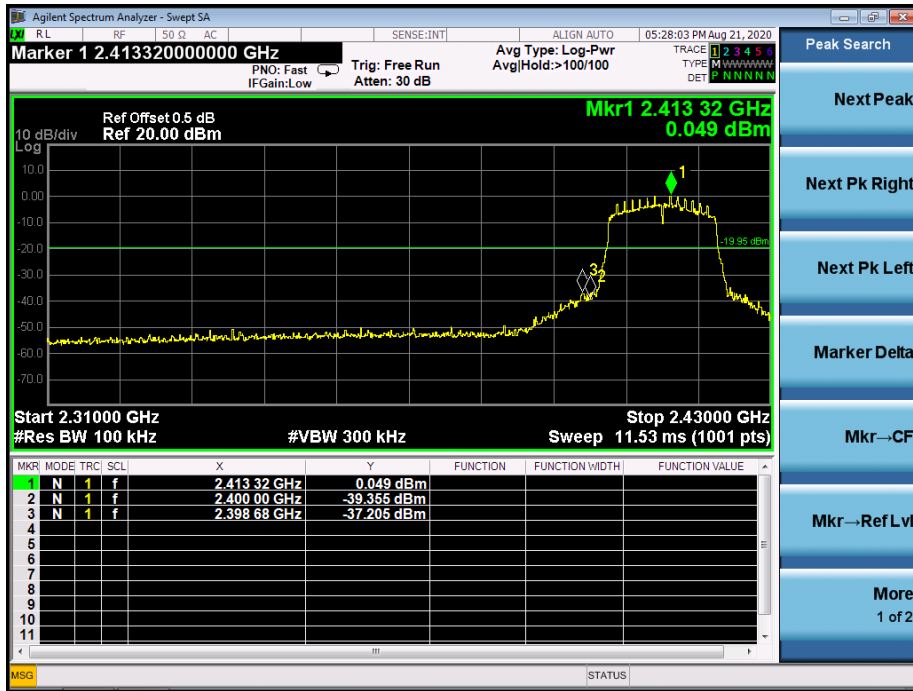

802.11n-HT20: Band Edge, Right Side



802.11n-HT40: Band Edge, Left Side

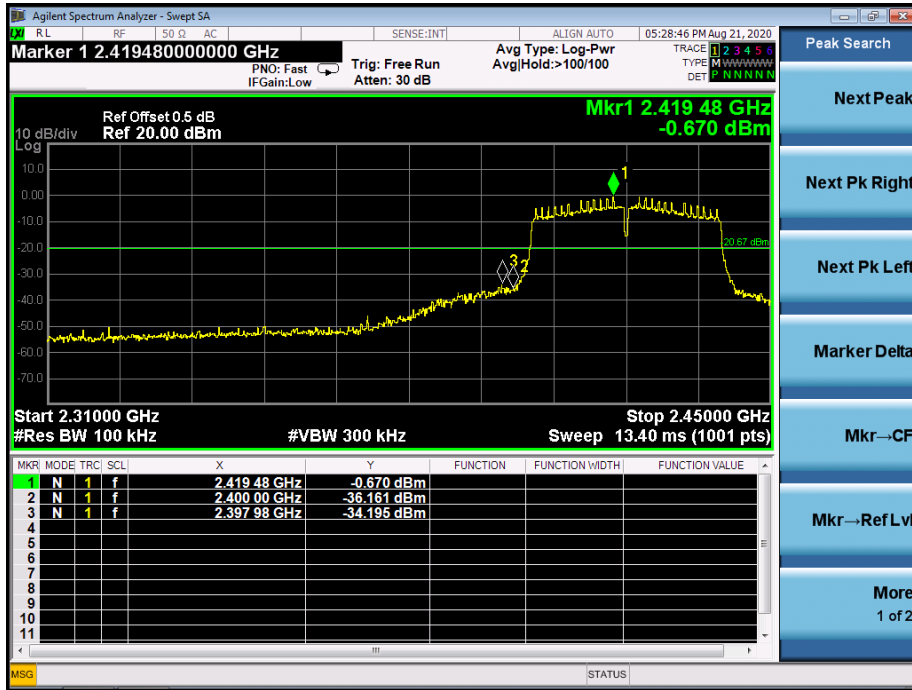

802.11n-HT40: Band Edge, Right Side

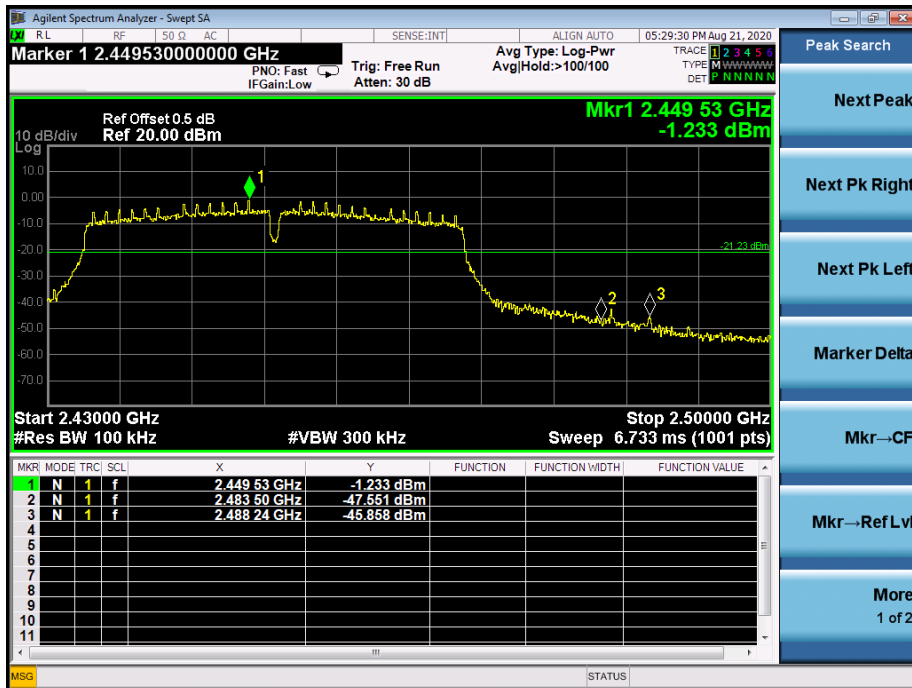



### CONDUCTED EMISSION MEASUREMENT

Note: A(B) Represent the value of antenna A and B, The worst data is Antenna B ,only shown Antenna B Plot.

802.11b

#### Low Channel 2412MHz

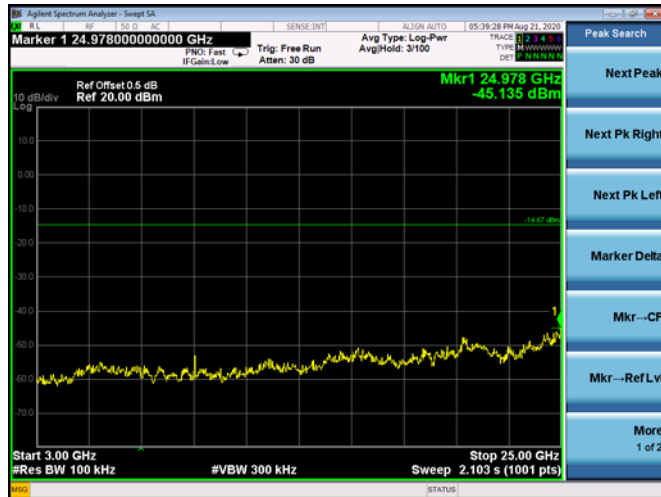
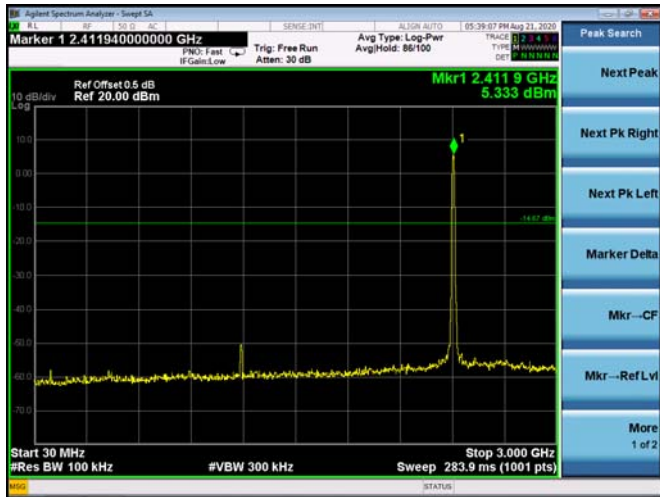

#### Middle Channel 2437MHz



#### High Channel 2462MHz

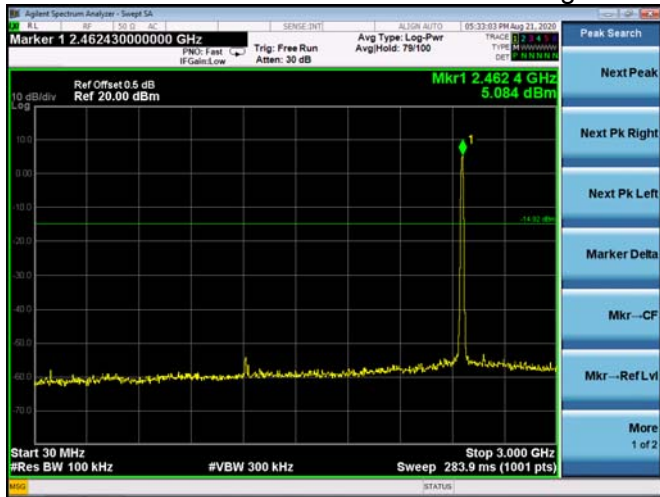

802.11g

Low Channel 2412MHz

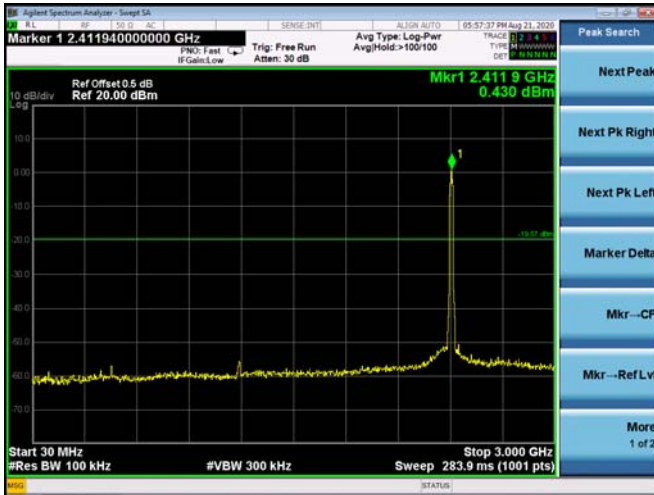

Middle Channel 2437MHz

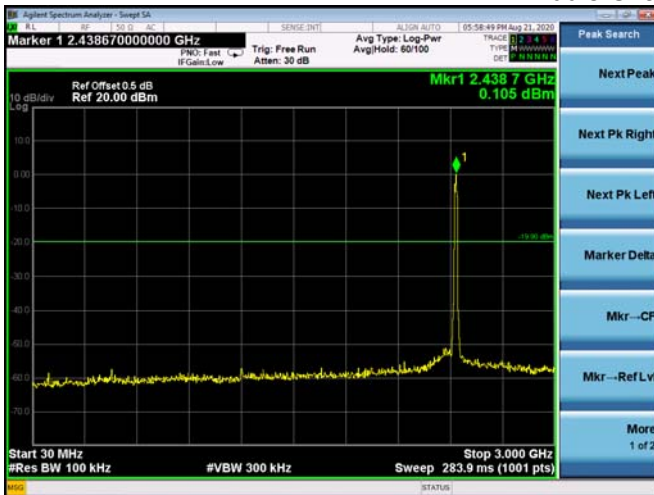

High Channel 2462MHz

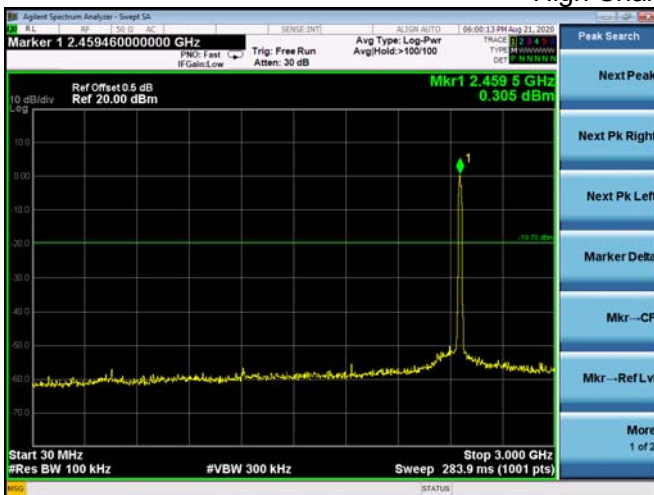

802.11n20

Low Channel 2412MHz

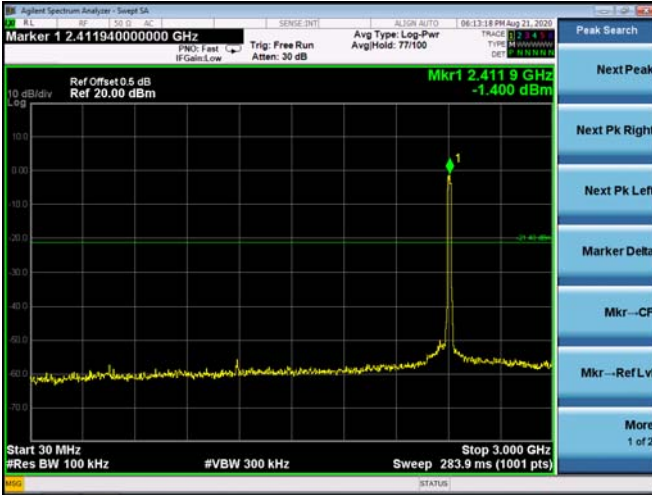

Middle Channel 2437MHz

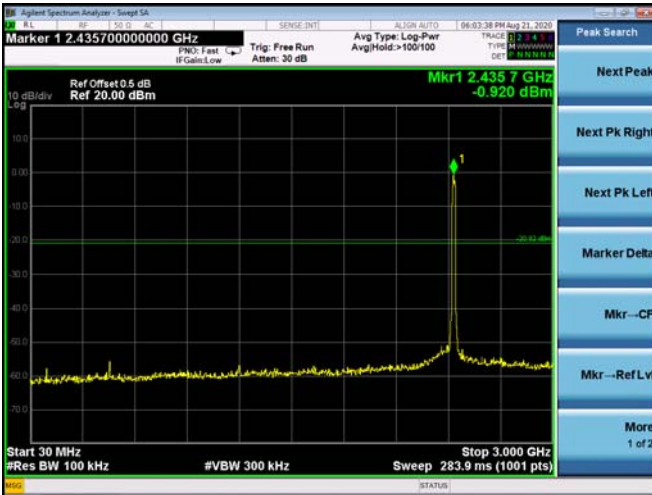

High Channel 2462MHz

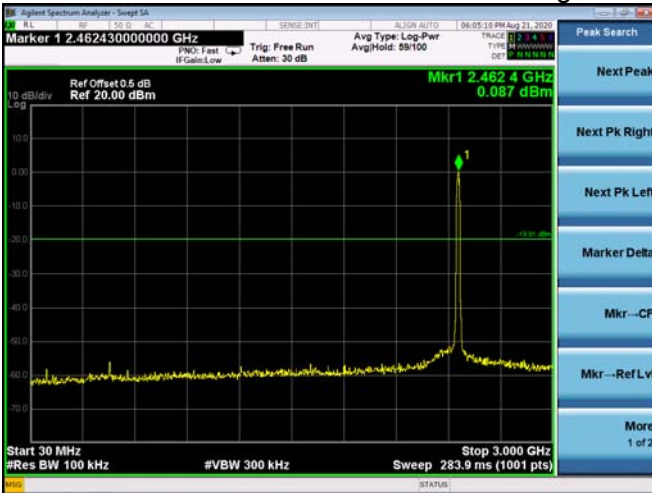



802.11n40

Low Channel 2422MHz

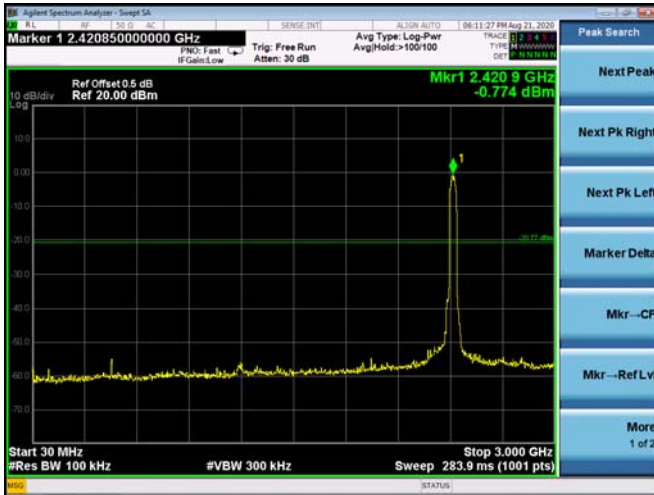

Middle Channel 2437MHz

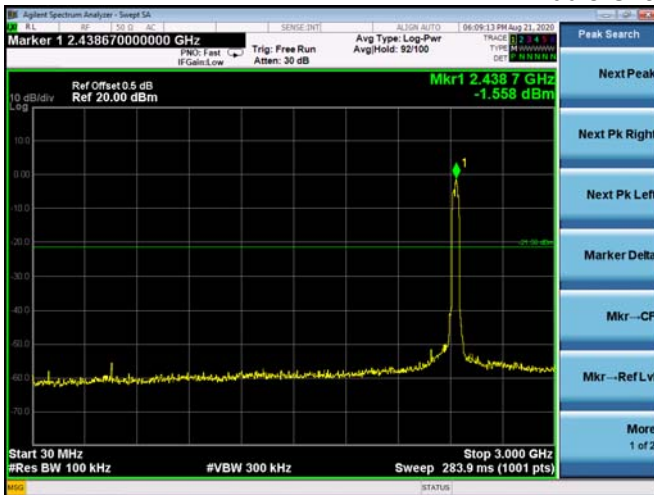

High Channel 2452MHz

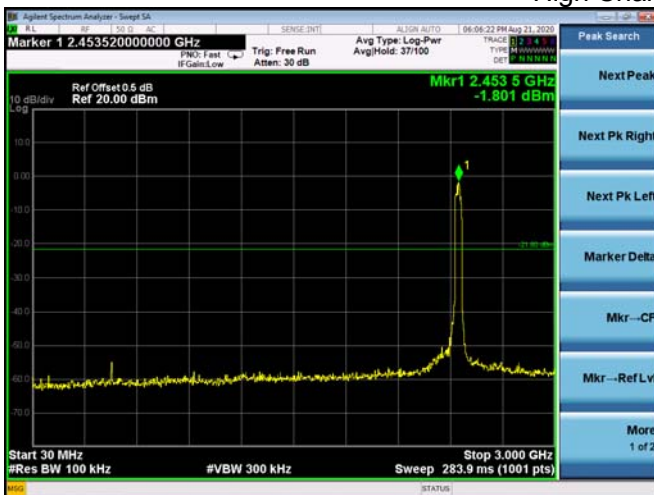

## 8. DUTY CYCLE OF TEST SIGNAL

### 8.1 STANDARD REQUIREMENT

Pre-analysis Check: While conducting average power measurement, duty cycle of each mode shall be checked to ensure its duty cycle in order to compensate for the loss due to insufficient ratio of duty cycle.

All duty cycle is pre-scanned, and result as obtained below shows only the most representative ones where duty cycle is conducted as the given transmission with given virtual operation that expresses the percentage.

### 8.2 FORMULA:

Duty Cycle =  $T_{on} / (T_{on} + T_{off})$

### Measurement Procedure:

1. Set span = Zero
2. RBW = 8MHz
3. VBW = 8MHz,
4. Detector = Peak

### Duty Cycle:

	Duty Cycle	Duty Fator (dB)
802.11b	1	0
802.11g	1	0
802.11n(HT20)	1	0
802.11n(HT40)	1	0

Note: A(B) Represent the value of antenna A and B, The worst data is Antenna A ,only shown Antenna A Plot.

802.11b

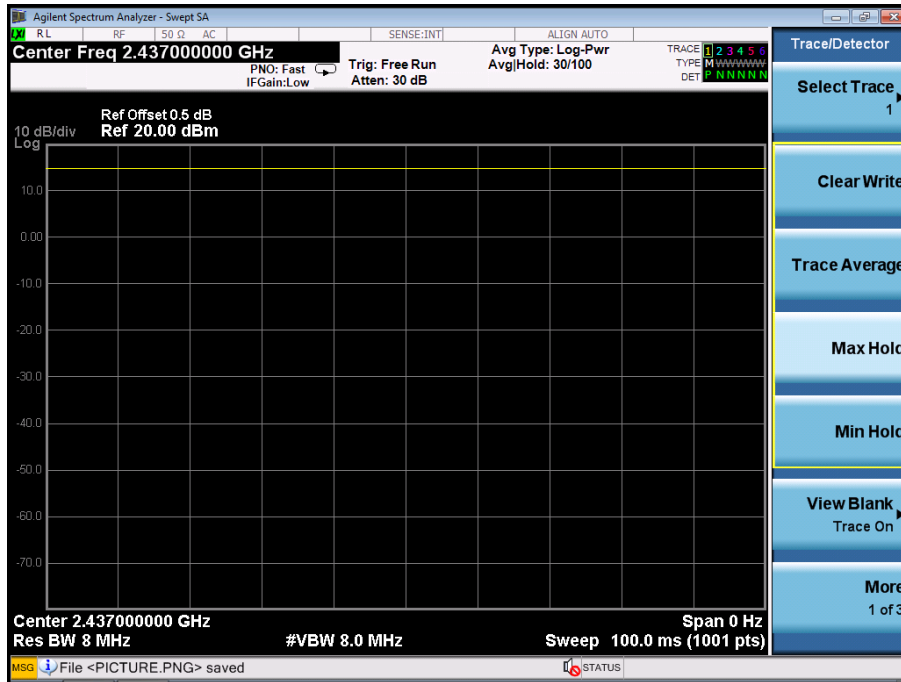

802.11g

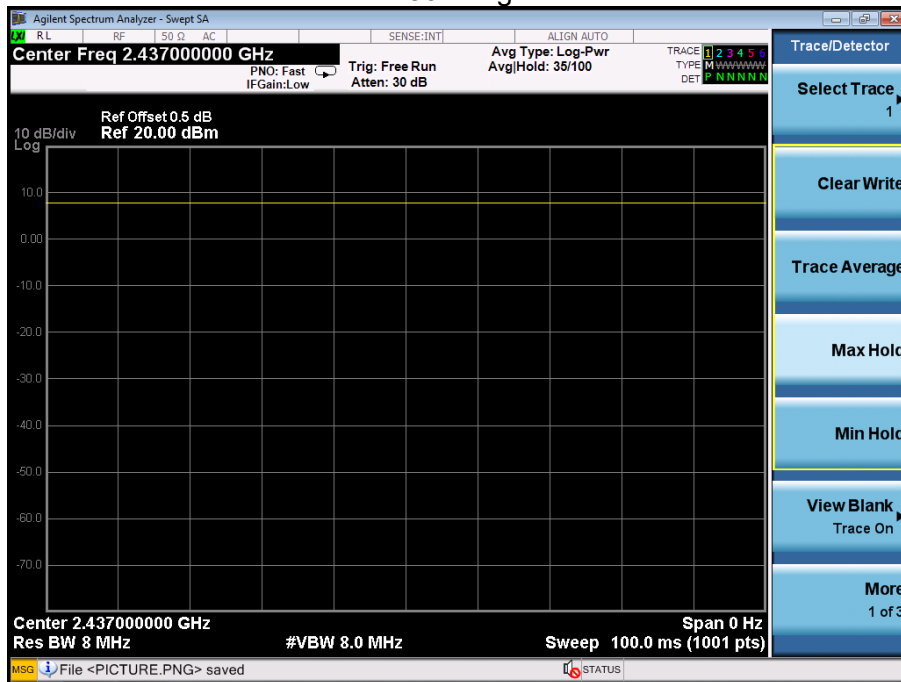

802.11n(HT20)

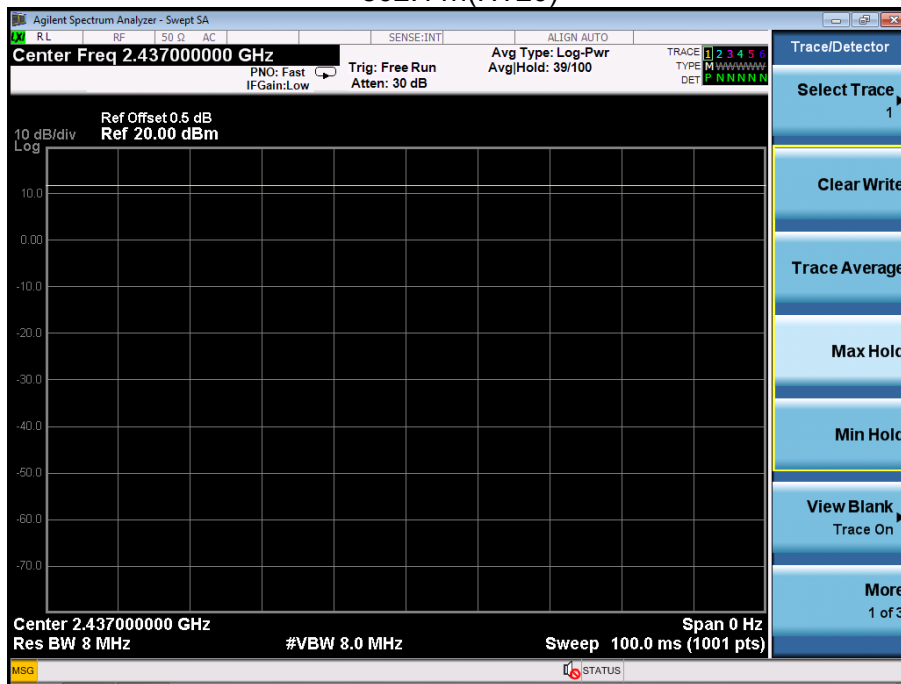

802.11n(HT40)

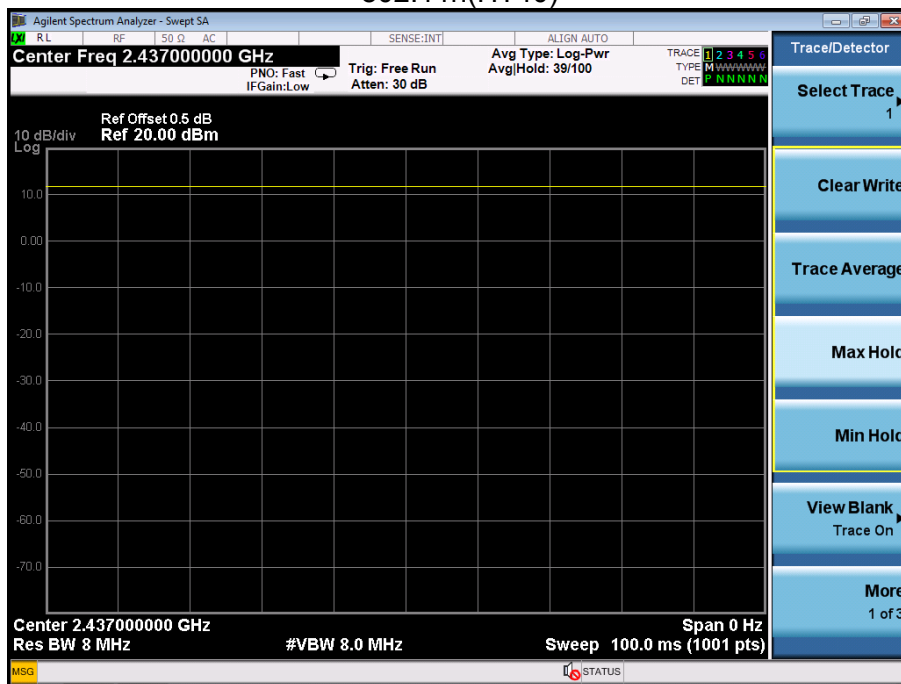

## 9. ANTENNA REQUIREMENT

### 9.1 STANDARD REQUIREMENT

15.203 requirement: For intentional device, according to 15.203: an intentional radiator shall be designed to ensure that no antenna other than that furnished by the responsible party shall be used with the device.

### 9.2 EUT ANTENNA

The EUT antenna is External antenna, antenna(A) Gain 2dBi, antenna(B) Gain 2dBi,, impedance 50Ω. It comply with the standard requirement.



## 10. EUT TEST PHOTO

### Conducted Measurement Photos



### Radiated Measurement Photos



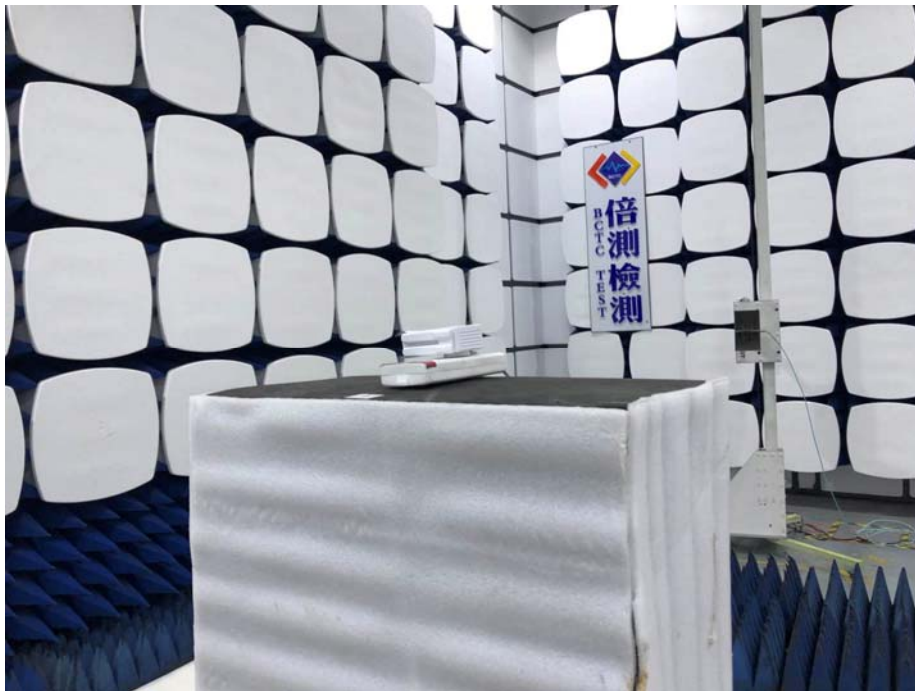

## 11. EUT PHOTO

EUT Photo 1



EUT Photo 2



\*\*\*\*\* END OF REPORT \*\*\*\*\*