

# Antenna test report

## 1. Antenna Dimension diagram(PCB antenna)

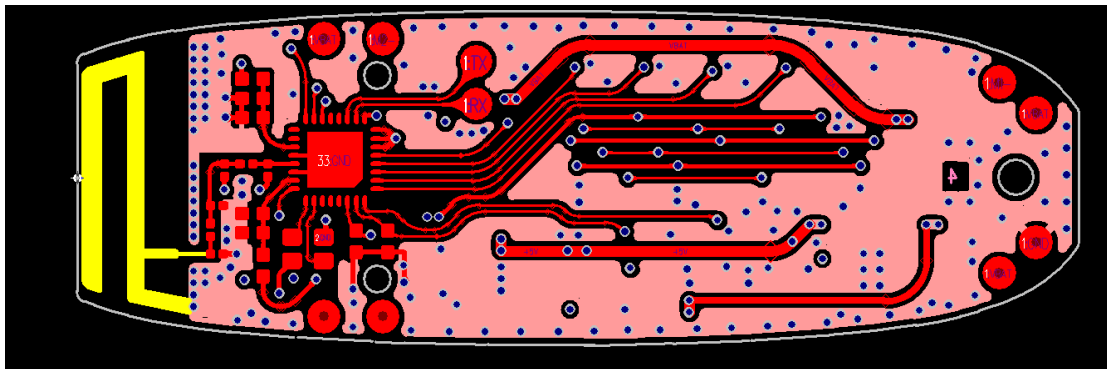

## 2. Antenna test diagram

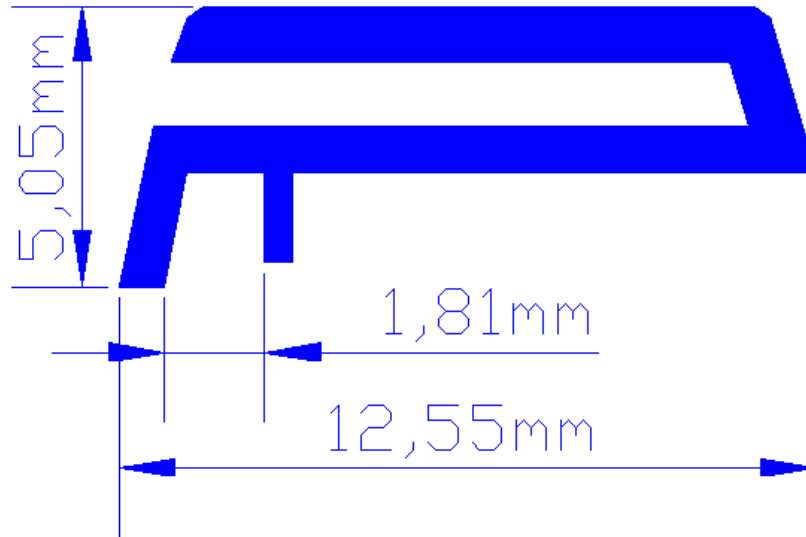

## 3. Smith chart



#### 4. ANT Gain

Freq (MHz)	Effi (%)	Gain (dBi)
2400	41.37	0.69
2410	40.74	0.40
2420	41.4	0.49
2430	42.67	0.68
2440	44.15	0.98
2450	45.51	1.00
2460	45.41	0.87
2470	44.97	0.65
2480	45.17	0.55
2490	46.59	0.70
2500	47.95	0.88

#### 5. 2D&3D test chart

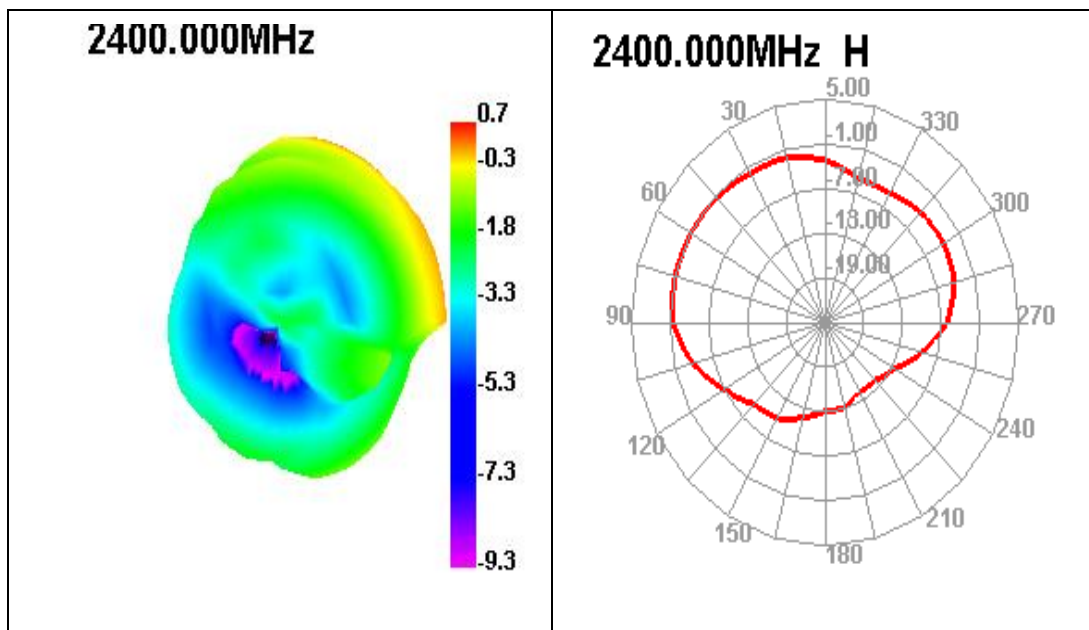

**2400.000MHz E1**

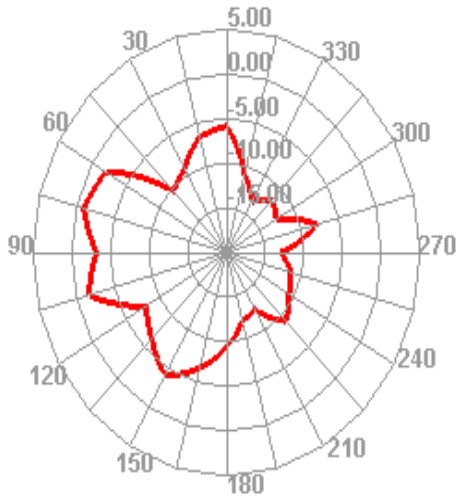

**2400.000MHz E2**

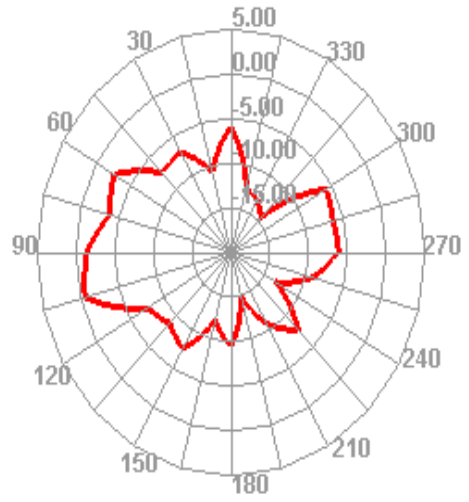

**2450.000MHz**

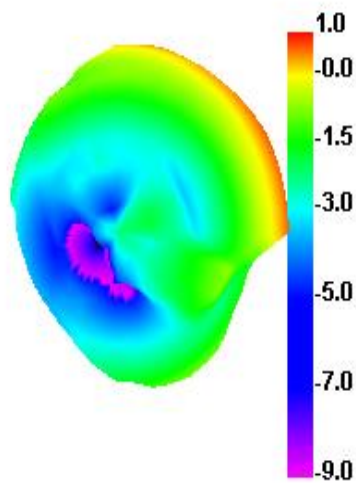

**2450.000MHz H**

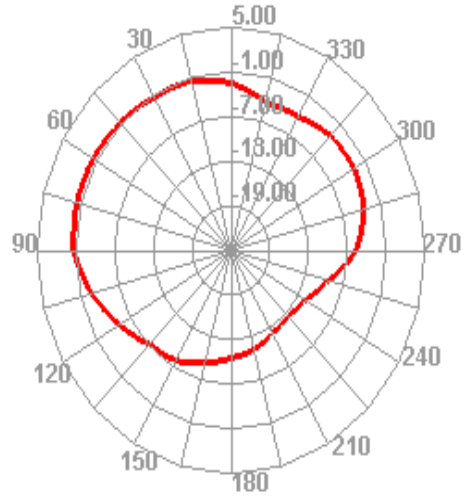

**2450.000MHz E1**

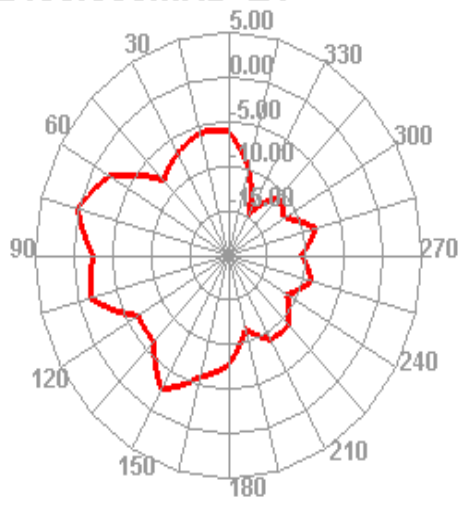

**2450.000MHz E2**

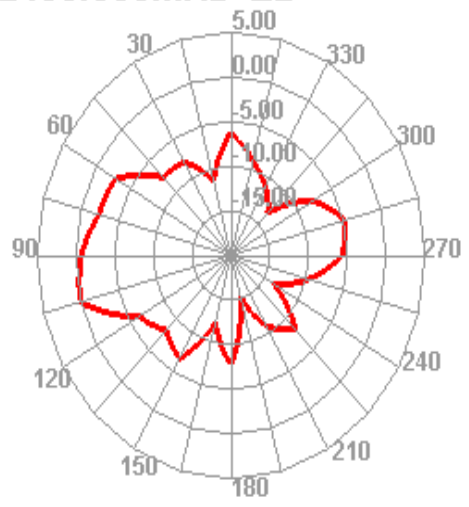

2500.000MHz

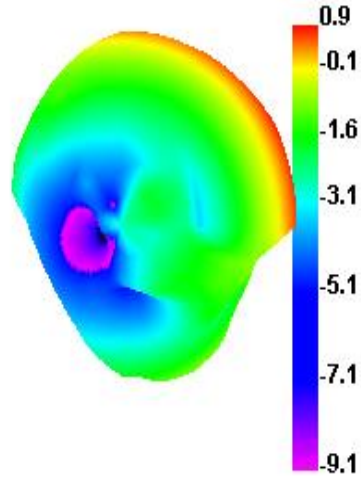

2500.000MHz H

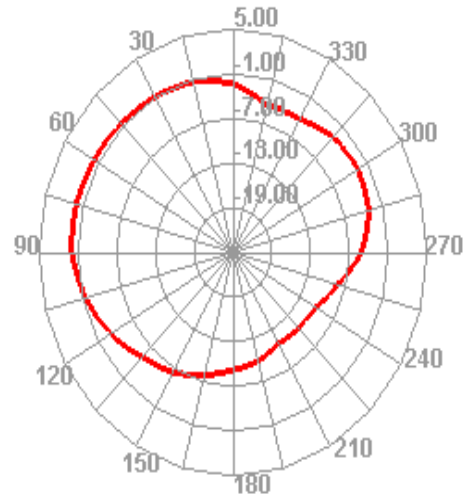

2500.000MHz E1

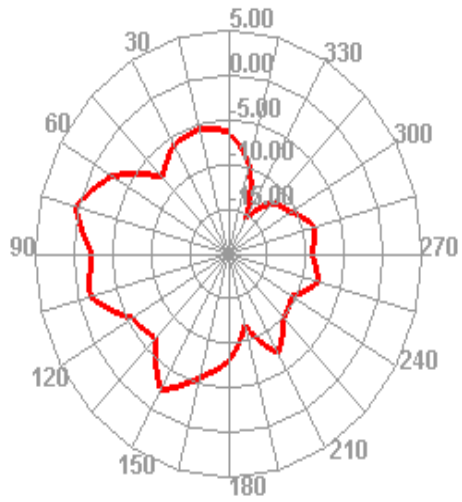

2500.000MHz E2

