

TEST REPORT

Product Name: Wireless keyboard
FCC ID: 2AXNMKMSONE
Trademark: Pall
Model Number: KMS-ONE, K619, K608, K301, K755
Prepared For: Tecnotropolis LLC
Address: 10840 NW 27 Street, Miami Florida 33172, United States
Manufacturer: Shenzhen Top One Electronics Ltd
Address: F3, Building 3, Dongwu industrial park, Donghuan 1st RD, Longhua District, Shenzhen 518109, China
Prepared By: Shenzhen CTB Testing Technology Co., Ltd.
Address: Floor 1&2, Building A, No. 26 of Xinghe Road, Xinqiao Community, Xinqiao Street, Baoan District, Shenzhen, Guangdong China
Sample Received Date: Jul. 6, 2021
Sample tested Date: Jul. 6, 2021 to Jul. 28, 2021
Issue Date: Jul. 28, 2021
Report No.: CTB210728005RF
Test Standards: FCC Part15.247
ANSI C63.10:2013
Test Results: PASS
Remark: This is **2.4GHz** radio test report.

Compiled by:

Arron Liu

Reviewed by:

Bin Mei

Approved by:

Rita Xiao / Director

The test report is effective only with both signature and specialized stamp. This result(s) shown in this report refer only to the sample(s) tested. Without written approval of Shenzhen CTB Testing Technology Co., Ltd. this report can't be reproduced except in full. The tested sample(s) and the sample information are provided by the client.

TABLE OF CONTENT

Test Report Declaration	Page
1. VERSION	4
2. TEST SUMMARY	5
3. MEASUREMENT UNCERTAINTY	6
4. PRODUCT INFORMATION AND TEST SETUP	7
4.1 Product Information	7
4.2 Test Setup Configuration	7
4.3 Support Equipment	7
4.4 Channel List	8
4.5 Test Mode	8
4.6 Test Environment	8
5. TEST FACILITY AND TEST INSTRUMENT USED	9
5.1 Test Facility	9
5.2 Test Instrument Used	9
6. AC POWER LINE CONDUCTED EMISSION	12
6.1 Block Diagram Of Test Setup	12
6.2 Limit	12
6.3 Test procedure	12
6.4 Test Result	14
7. RADIATED SPURIOUS EMISSION	16
7.1 Block Diagram Of Test Setup	16
7.2 Limit	16
7.3 Test procedure	17
7.4 Test Result	18
8. BAND EDGE AND RF CONDUCTED SPURIOUS EMISSIONS	27
8.1 Block Diagram Of Test Setup	27
8.2 Limit	27
8.3 Test procedure	27
9. CONDUCTED PEAK OUTPUT POWER	31
9.1 Block Diagram Of Test Setup	31
9.2 Limit	31
9.3 Test procedure	31
9.4 Test Result	32
10. 20DB OCCUPIED BANDWIDTH	34
10.1 Block Diagram Of Test Setup	34
10.2 Limit	34
10.3 Test procedure	34
10.4 Test Result	34
11. CARRIER FREQUENCIES SEPARATION	36
11.1 Block Diagram Of Test Setup	36
11.2 Limit	36
11.3 Test procedure	36

11.4	Test Result	36
12.	HOPPING CHANNEL NUMBER	38
12.1	Block Diagram Of Test Setup	38
12.2	Limit	38
12.3	Test procedure	38
12.4	Test Result	38
13.	DWELL TIME	40
13.1	Block Diagram Of Test Setup	40
13.2	Limit	40
13.3	Test procedure	40
13.4	Test Result	41
14.	PSEUDORANDOM FREQUENCY	43
14.1	Limit	43
14.2	Test procedure	43
14.3	Test Result	44
15.	ANTENNA REQUIREMENT	45
16.	EUT PHOTOGRAPHS	46
17.	EUT TEST SETUP PHOTOGRAPHS	50

(Note: N/A means not applicable)

1. VERSION

Report No.	Issue Date	Description	Approved
CTB210728005RF	Jul. 28, 2021	Original	Valid

2. TEST SUMMARY

The Product has been tested according to the following specifications:

Test Item	Test Requirement	Test method	Result
AC Power Line Conducted Emission	47 CFR Part 15 Subpart C Section 15.207	ANSI C63.10-2013	PASS
Radiated Spurious emissions	47 CFR Part 15 Subpart C Section 15.205/15.209	ANSI C63.10-2013	PASS
Band edge and RF Conducted Spurious Emissions	47 CFR Part 15 Subpart C Section 15.247(d)/15.205(a)	ANSI C63.10-2013	PASS
Conducted Peak Output Power	47 CFR Part 15 Subpart C Section 15.247 (b)(1)	ANSI C63.10-2013	PASS
20dB Occupied Bandwidth	47 CFR Part 15 Subpart C Section 15.247 (a)(1)	ANSI C63.10-2013	PASS
Carrier Frequencies Separation	47 CFR Part 15 Subpart C Section 15.247 (a)(1)	ANSI C63.10-2013	PASS
Hopping Channel Number	47 CFR Part 15 Subpart C Section 15.247 (b)	ANSI C63.10-2013	PASS
Dwell Time	47 CFR Part 15 Subpart C Section 15.247 (a)(1)	ANSI C63.10-2013	PASS
Pseudorandom Frequency Hopping Sequence	47 CFR Part 15 Subpart C Section 15.247(b)(4)&TCB Exclusion List (7 July 2002)	ANSI C63.10-2013	PASS
Antenna Requirement	47 CFR Part 15 Subpart C Section 15.203/15.247 (c)	ANSI C63.10-2013	PASS
RF Exposure Evaluation	47 CFR Part 15 Subpart C Section 15.247 (i)/1.1310/2.1093	KDB447498D01v06	PASS

Remark:

Test according to ANSI C63.4-2014 & ANSI C63.10-2013.

3. MEASUREMENT UNCERTAINTY

Where relevant, the following measurement uncertainty levels have been estimated for tests performed on the Product as specified in CISPR 16-4-2. This uncertainty represents an expanded uncertainty expressed at approximately the 95% confidence level using a coverage factor of $k=2$.

Item	Uncertainty
Occupancy bandwidth	54.3kHz
Conducted output power Above 1G	0.9dB
Conducted output power below 1G	0.9dB
Power Spectral Density , Conduction	0.9dB
Conduction spurious emissions	2.0dB
Out of band emission	2.0dB
3m chamber Radiated spurious emission(30MHz-1GHz)	4.6dB
3m chamber Radiated spurious emission(1GHz-18GHz)	5.1dB
3m chamber Radiated spurious emission(18GHz-40GHz)	3.4dB
humidity uncertainty	5.5%
Temperature uncertainty	0.63°C
frequency	1×10^{-7}
Conducted Emission (150KHz-30MHz)	3.2 dB
Radiated Emission(30MHz ~ 1000MHz)	4.8 dB
Radiated Emission(1GHz ~6GHz)	4.9 dB

4. PRODUCT INFORMATION AND TEST SETUP

4.1 Product Information

Model(s):	KMS-ONE, K619, K608, K301, K755
Model Description:	All the model are the same circuit and RF module, only for model name. Test sample model: KMS-ONE
Hardware Version:	V1.0
Software Version:	V1.0
Operation Frequency:	2402-2480MHz
Max. RF output power:	0.013dBm
Type of Modulation:	GFSK
Antenna installation:	PCB antenna
Antenna Gain:	2.34dBi
Ratings:	DC 3.7V from battery DC 5V from adapter

4.2 Test Setup Configuration

See test photographs attached in EUT TEST SETUP PHOTOGRAPHS for the actual connections between Product and support equipment.

4.3 Support Equipment

Item	Equipment	Mfr/Brand	Model/Type No.	Series No.	Note
1.	Adapter	HUAWEI	HW-050200C 01	N/A	AE
2.	Notebook	DELL	Vostro 5490	N/A	AE

Notes:

- All the equipment/cables were placed in the worst-case configuration to maximize the emission during the test.
- Grounding was established in accordance with the manufacturer's requirements and conditions for the intended use.

4.4 Channel List

CH	Frequency (MHz)	CH	Frequency (MHz)	CH	Frequency (MHz)	CH	Frequency (MHz)
0	2402	1	2403	2	2404	3	2405
4	2406	5	2407	6	2408	7	2409
8	2410	9	2411	10	2412	11	2413
12	2414	13	2415	14	2416	15	2417
16	2418	17	2419	18	2420	19	2421
20	2422	21	2423	22	2424	23	2425
24	2426	25	2427	26	2428	27	2429
28	2430	29	2431	30	2432	31	2433
32	2434	33	2435	34	2436	35	2437
36	2438	37	2439	38	2440	39	2441
40	2442	41	2443	42	2444	43	2445
44	2446	45	2447	46	2448	47	2449
48	2450	49	2451	50	2452	51	2453
52	2454	53	2455	54	2456	55	2457
56	2458	57	2459	58	2460	59	2461
60	2462	61	2463	62	2464	63	2465
64	2466	65	2467	66	2468	67	2469
68	2470	69	2471	70	2472	71	2473
72	2474	73	2475	74	2476	75	2477
76	2478	77	2479	78	2480	79	/

4.5 Test Mode

All test mode(s) and condition(s) mentioned were considered and evaluated respectively by performing full tests, the worst data were recorded and reported.

Test mode	Low channel	Middle channel	High channel
Transmitting (GFSK)	2402MHz	2441MHz	2480MHz
Receiving (GFSK)	2402MHz	2441MHz	2480MHz

4.6 Test Environment

Humidity(%):	55
Atmospheric Pressure(kPa):	101.1
Normal Voltage(DC):	3.7V
Normal Temperature(°C)	25
Low Temperature(°C)	0
High Temperature(°C)	40

5. TEST FACILITY AND TEST INSTRUMENT USED

5.1 Test Facility

All measurement facilities used to collect the measurement data are located at Floor 1&2, Building A, No. 26 of Xinhe Road, Xinqiao Street, Baoan District, Shenzhen China. The site and apparatus are constructed in conformance with the requirements of ANSI C63.10 and CISPR 16-1-1 other equivalent standards.

5.2 Test Instrument Used

No.	Equipment	Manufacturer	Model No.	Serial No.	Calibrated date	Calibrated until
1	Spectrum Analyzer	Agilent	N9020A	MY52090073	2020.09.27	2021.09.27
2	Power Sensor	Agilent	U2021XA	MY56120032	2020.09.27	2021.09.27
3	Power Sensor	Agilent	U2021XA	MY56120034	2020.09.27	2021.09.27
4	Communication test set	R&S	CMW500	108058	2020.09.27	2021.09.27
5	Spectrum Analyzer	R&S	FSP40	100550	2020.09.27	2021.09.27
6	Signal Generator	Agilent	N5181A	MY49060920	2020.09.27	2021.09.27
7	Signal Generator	Agilent	N5182A	MY47420195	2020.09.27	2021.09.27
8	Communication test set	Agilent	E5515C	MY50102567	2020.09.27	2021.09.27
9	band rejection filter	Shenxiang	MSF2400-2483.5MS-1154	20181015001	2020.09.27	2021.09.27
10	band rejection filter	Shenxiang	MSF5150-5850 MS-1155	20181015001	2020.09.27	2021.09.27
11	band rejection filter	Xingbo	XBLBQ-DZA120	190821-1-1	2020.09.27	2021.09.27
12	BT&WI-FI Automatic test software	Microwave	MTS8310	Ver. 2.0.0.0	2020.09.27	2021.09.27
13	Rohde & Schwarz SFU Broadcast Test System	R&S	SFU	101017	2020.09.27	2021.09.27
14	Temperature humidity chamber	Hongjing	TH-80CH	DG-15174	2020.09.27	2021.09.27
15	234G Automatic test software	Microwave	MTS8200	Ver. 2.0.0.0	2020.09.27	2021.09.27
16	966 chamber	C.R.T.	966 Room	966	2020.09.27	2021.09.27
17	Receiver	R&S	ESPI	100362	2020.09.27	2021.09.27
18	Amplifier	HP	8447E	2945A02747	2020.09.27	2021.09.27

19	Amplifier	Agilent	8449B	3008A01838	2020.09.27	2021.09.27
20	TRILOG Broadband Antenna	Schwarzbeck	VULB 9163	869	2020.09.27	2021.09.27
21	Horn Antenna	Schwarzbeck	BBHA9120D	1911	2020.09.27	2021.09.27
22	Software	Fala	EZ-EMC	FA-03A2 RE	2020.09.27	2021.09.27
23	3-Loop Antenna	Daze	ZN30401	17014	2020.09.27	2021.09.27
24	loop antenna	ZHINAN	ZN30900A	/	2020.09.27	2021.09.27
25	Horn antenna	A/H/System	SAS-574	588	2020.09.27	2021.09.27
26	Amplifier	AEROFLEX	/	S/N/ 097	2020.09.27	2021.09.27

Continuous disturbance

No.	Equipment	Manufacturer	Model No.	Serial No.	Calibrated date	Calibrated until
1	AMN	ROHDE&SCHWARZ	ESH3-Z5	831551852	2020.09.27	2021.09.27
2	Pulse limiter	ROHDE&SCHWARZ	ESH3Z2	357881052	2020.09.27	2021.09.27
3	EMI TEST RECEIVER	ROHDE&SCHWARZ	ESCS30	834115/006	2020.09.27	2021.09.27
4	Coaxial cable	ZDECL	Z302S	18091904	2020.09.27	2021.09.27
5	AAN	Schwarzbeck	NTFM8158	183	2020.09.27	2021.09.27
6	Communication test set	Agilent	E5515C	MY50102567	2020.09.27	2021.09.27
7	Communication test set	R&S	CMW500	108058	2020.09.27	2021.09.27
8	EZ-EMC	Frad	EMC-con3A1.1	/	/	/

Radiated emission

No.	Equipment	Manufacturer	Model No.	Serial No.	Calibrated date	Calibrated until
1	Double Ridged Broadband Horn Antenna	Schwarzbeck	BBHA 9120D	1911	2020.09.27	2021.11.01
2	TRILOG Broadband Antenna	Schwarzbeck	VULB 9168	869	2020.09.27	2021.11.01
3	Amplifier	Agilent	8449B	3008A01838	2020.09.27	2021.09.27
4	Amplifier	HP	8447E	2945A02747	2020.09.27	2021.09.27
5	EMI TEST RECEIVER	ROHDE&SCHWARZ	ESPI7	100362	2020.09.27	2021.09.27
6	Coaxial cable	ETS	RFC-SNS-100-NMS-80 NI	/	2020.09.27	2021.09.27
7	Coaxial cable	ETS	RFC-SNS-100-NMS-20 NI	/	2020.09.27	2021.09.27

8	Coaxial cable	ETS	RFC-SNS-100-SMS-20 NI	/	2020.09.27	2021.09.27
9	Coaxial cable	ETS	RFC-NNS-100-NMS-300 NI	/	2020.09.27	2021.09.27
10	Communication test set	Agilent	E5515C	MY50102567	2020.09.27	2021.09.27
11	Communication test set	R&S	CMW500	108058	2020.09.27	2021.09.27
12	EZ-EMC	Frad	EMC-con3A1.1	/	/	/

6. AC POWER LINE CONDUCTED EMISSION

6.1 Block Diagram Of Test Setup

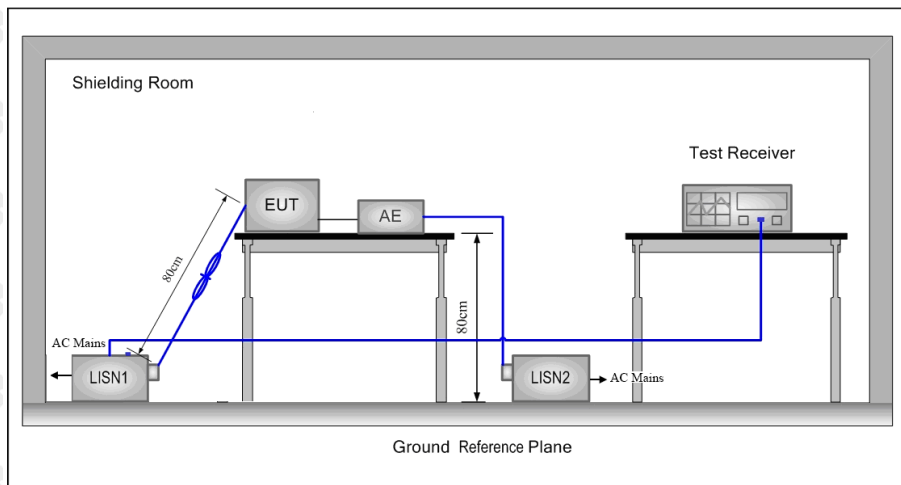

6.2 Limit

Frequency (MHz)	Maximum RF Line Voltage (dB μ V)			
	CLASS A		CLASS B	
	Q.P.	Ave.	Q.P.	Ave.
0.15 - 0.50	79	66	66-56*	56-46*
0.50 - 5.00	73	60	56	46
5.00 - 30.0	73	60	60	50

* Decreasing linearly with the logarithm of the frequency

6.3 Test procedure

- 1) The mains terminal disturbance voltage test was conducted in a shielded room.
- 2) The EUT was connected to AC power source through a LISN 1 (Line Impedance Stabilization Network) which provides a $50\Omega/50\mu\text{H} + 5\Omega$ linear impedance. The power cables of all other units of the EUT were connected to a second LISN 2, which was bonded to the ground reference plane in the same way as the LISN 1 for the unit being measured. A multiple socket outlet strip was used to connect multiple power cables to a single LISN provided the rating of the LISN was not exceeded.
- 3) The tabletop EUT was placed upon a non-metallic table 0.8m above the ground reference plane. And for floor-standing arrangement, the EUT was placed on the horizontal ground reference plane,
- 4) The test was performed with a vertical ground reference plane. The rear of the EUT shall be 0,4 m from the vertical ground reference plane. The vertical ground reference plane was bonded to the horizontal ground reference plane. The LISN 1 was placed 0,8 m from the boundary of the unit under test and bonded to a ground reference plane for LISNs mounted on top of the ground reference plane. This distance was between the closest points of the LISN 1 and the EUT. All other units of the EUT and associated equipment was at least 0,8 m from the LISN 2.

- 5) In order to find the maximum emission, the relative positions of equipment and all of the interface cables must be changed according to ANSI C63.10 on conducted measurement.
- 6) All modes were tested at AC 120V and 240V, only the worst result of AC 120V 60Hz was reported.
- 7) If a EUT received DC power from the USB Port of Notebook PC, the PC's adapter received AC120V/60Hz power through a Line Impedance Stabilization Network (LISN) which supplied power source and was grounded to the ground plane.

6.4 Test Result

L:

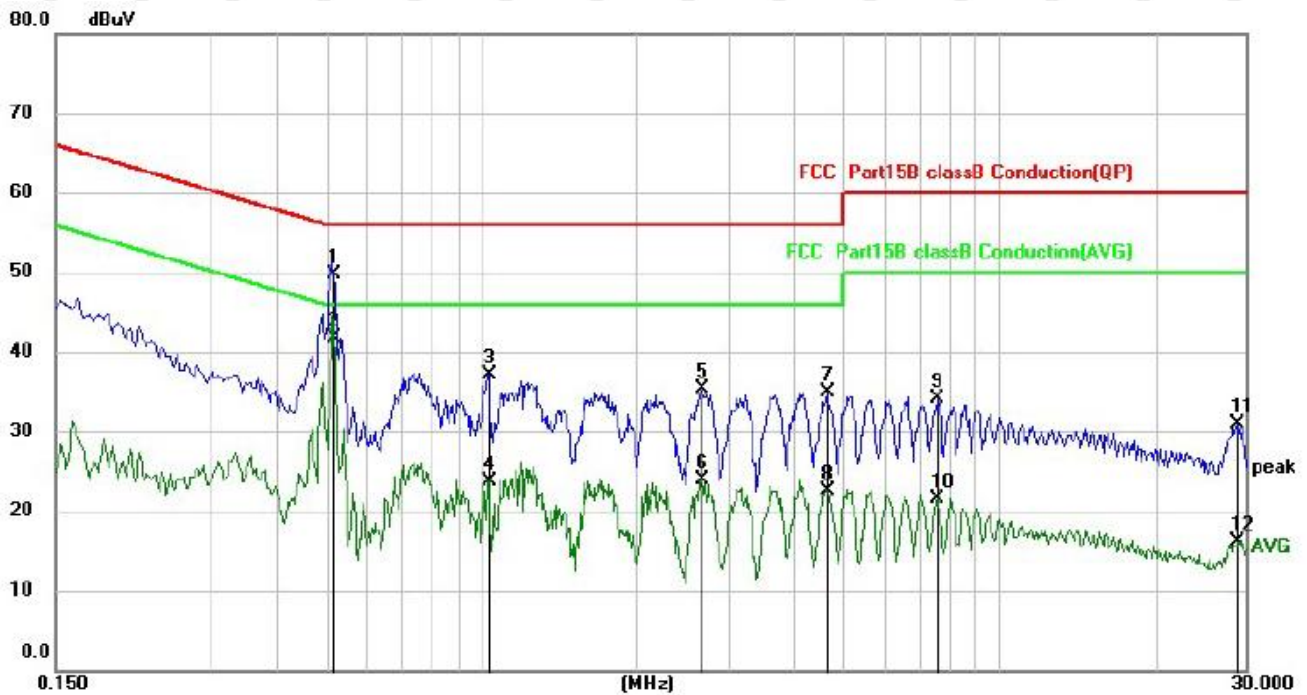

No.	Mk.	Freq. MHz	Reading Level dBuV	Correct Factor dB	Measure- ment dBuV	Limit dBuV	Margin dB	Detector
1		0.5180	39.72	9.96	49.68	56.00	-6.32	QP
2	*	0.5180	31.79	9.96	41.75	46.00	-4.25	AVG
3		1.0300	27.16	9.96	37.12	56.00	-18.88	QP
4		1.0300	13.67	9.96	23.63	46.00	-22.37	AVG
5		2.6619	25.19	10.05	35.24	56.00	-20.76	QP
6		2.6619	13.84	10.05	23.89	46.00	-22.11	AVG
7		4.6620	24.81	10.15	34.96	56.00	-21.04	QP
8		4.6620	12.45	10.15	22.60	46.00	-23.40	AVG
9		7.5900	23.64	10.50	34.14	60.00	-25.86	QP
10		7.5900	11.00	10.50	21.50	50.00	-28.50	AVG
11		28.7820	19.69	11.28	30.97	60.00	-29.03	QP
12		28.7820	4.82	11.28	16.10	50.00	-33.90	AVG

Remark:

Factor = Cable loss + LISN factor, Margin = Measurement – Limit

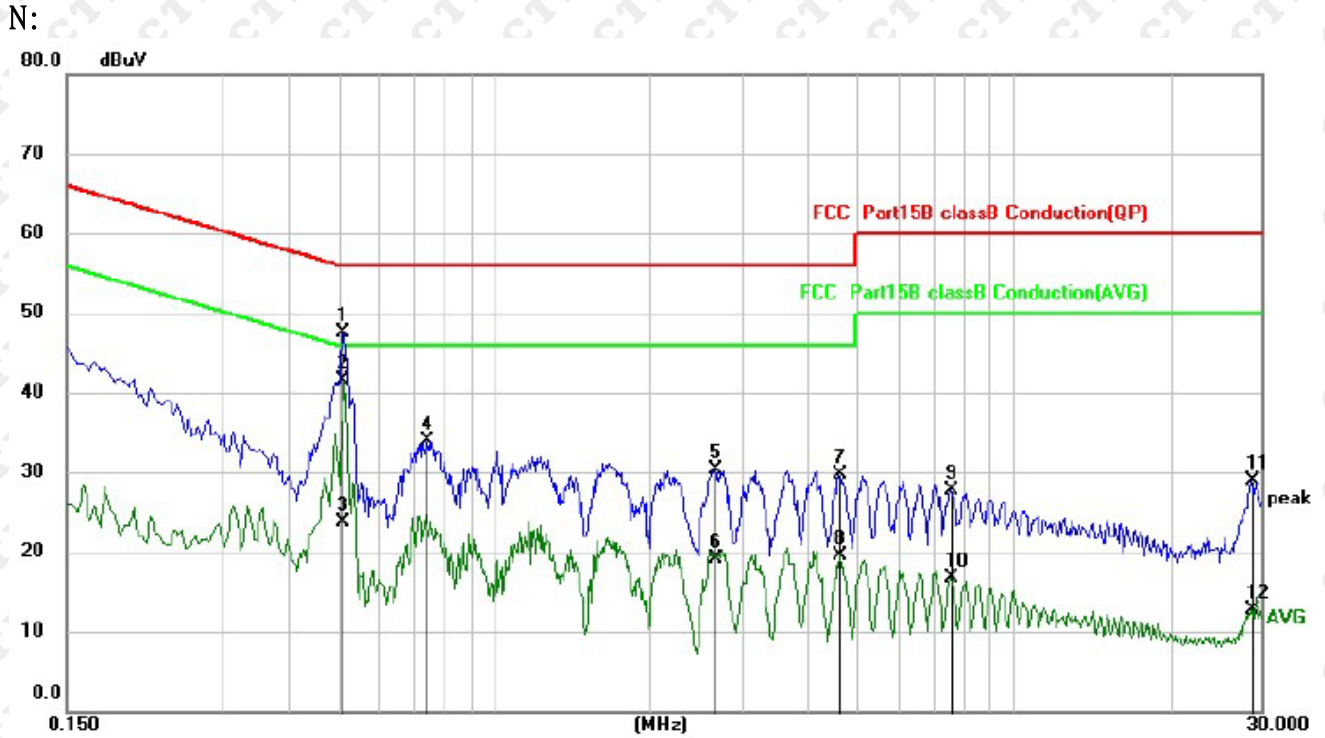

No.	Mk.	Freq. MHz	Reading Level dBuV	Correct Factor dB	Measure- ment dBuV	Limit dBuV	Margin dB	Detector
1		0.5100	37.45	9.96	47.41	56.00	-8.59	QP
2	*	0.5100	31.52	9.96	41.48	46.00	-4.52	AVG
3		0.5100	13.69	9.96	23.65	46.00	-22.35	AVG
4		0.7420	24.04	9.96	34.00	56.00	-22.00	QP
5		2.6619	20.30	10.05	30.35	56.00	-25.65	QP
6		2.6619	9.02	10.05	19.07	46.00	-26.93	AVG
7		4.5980	19.51	10.15	29.66	56.00	-26.34	QP
8		4.5980	9.30	10.15	19.45	46.00	-26.55	AVG
9		7.5620	17.24	10.49	27.73	60.00	-32.27	QP
10		7.5620	6.25	10.49	16.74	50.00	-33.26	AVG
11		28.6260	17.56	11.28	28.84	60.00	-31.16	QP
12		28.6260	1.47	11.28	12.75	50.00	-37.25	AVG

Remark:

Factor = Cable loss + LISN factor, Margin = Measurement – Limit

7. RADIATED SPURIOUS EMISSION

7.1 Block Diagram Of Test Setup

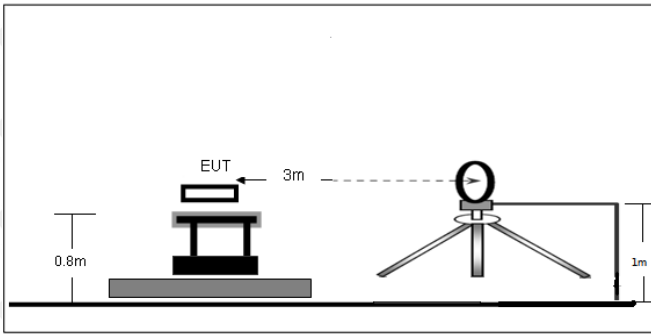

Figure 1. Below 30MHz

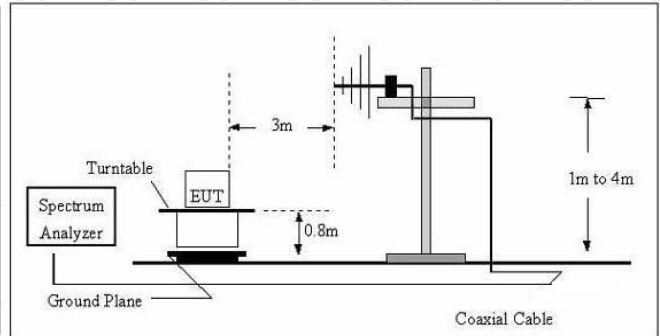

Figure 2. 30MHz to 1GHz

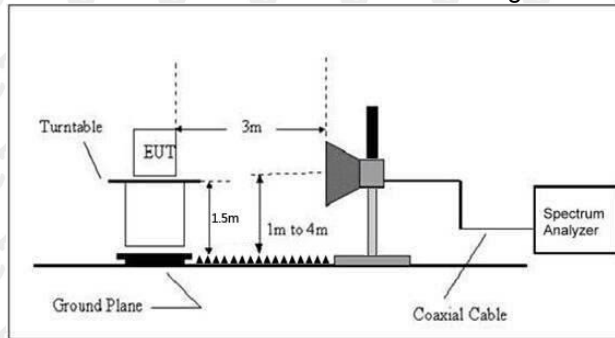

Figure 3. Above 1GHz

7.2 Limit

Spurious Emissions:

Frequency	Field strength (microvolt/meter)	Limit (dB μ V/m)	Remark	Measurement distance (m)
0.009MHz-0.490MHz	2400/F (kHz)	-	-	300
0.490MHz-1.705MHz	24000/F (kHz)	-	-	30
1.705MHz-30MHz	30	-	-	30
30MHz-88MHz	100	40.0	Quasi-peak	3
88MHz-216MHz	150	43.5	Quasi-peak	3
216MHz-960MHz	200	46.0	Quasi-peak	3
960MHz-1GHz	500	54.0	Quasi-peak	3
Above 1GHz	500	54.0	Average	3

Note: 15.35(b), Unless otherwise specified, the limit on peak radio frequency emissions is 20dB above the maximum permitted average emission limit applicable to the equipment under test. This peak limit applies to the total peak emission level radiated by the device.

7.3 Test procedure

Below 1GHz test procedure as below:

- a. The EUT was placed on the top of a rotating table 0.8 meters above the ground at a 3 meter semi-anechoic chamber. The table was rotated 360 degrees to determine the position of the highest radiation.
- b. The EUT was set 3 meters away from the interference-receiving antenna, which was mounted on the top of a variable-height antenna tower.
- c. The antenna height is varied from one meter to four meters above the ground to determine the maximum value of the field strength. Both horizontal and vertical polarizations of the antenna are set to make the measurement.
- d. For each suspected emission, the EUT was arranged to its worst case and then the antenna was tuned to heights from 1 meter to 4 meters (for the test frequency of below 30MHz, the antenna was tuned to heights 1 meter) and the rota table table was turned from 0 degrees to 360 degrees to find the maximum reading.
- e. The test-receiver system was set to Peak Detect Function and Specified Bandwidth with Maximum Hold Mode.
- f. If the emission level of the EUT in peak mode was 10dB lower than the limit specified, then testing could be stopped and the peak values of the EUT would be reported. Otherwise the emissions that did not have 10dB margin would be re-tested one by one using peak, quasi-peak or average method as specified and then reported in a data sheet.

Above 1GHz test procedure as below:

- g. Different between above is the test site, change from Semi- Anechoic Chamber to fully Anechoic Chamber and change form table 0.8 meter to 1.5 meter(Above 18GHz the distance is 1 meter and table is 1.5 meter).
- h. Test the EUT in the lowest channel ,the middle channel ,the Highest channel
- j. Repeat above procedures until all frequencies measured was complete.
- j. Full battery is used during test

Receiver set:

Frequency	Detector	RBW	VBW	Remark
0.009MHz-0.090MHz	Peak	10kHz	30KHz	Peak
0.009MHz-0.090MHz	Average	10kHz	30KHz	Average
0.090MHz-0.110MHz	Quasi-peak	10kHz	30KHz	Quasi-peak
0.110MHz-0.490MHz	Peak	10kHz	30KHz	Peak
0.110MHz-0.490MHz	Average	10kHz	30KHz	Average
0.490MHz -30MHz	Quasi-peak	10kHz	30kHz	Quasi-peak
30MHz-1GHz	Quasi-peak	120 kHz	300KHz	Quasi-peak
Above 1GHz	Peak	1MHz	3MHz	Peak
	Peak	1MHz	10Hz	Average

7.4 Test Result

Below 1GHz Test Results:
Antenna polarity: H

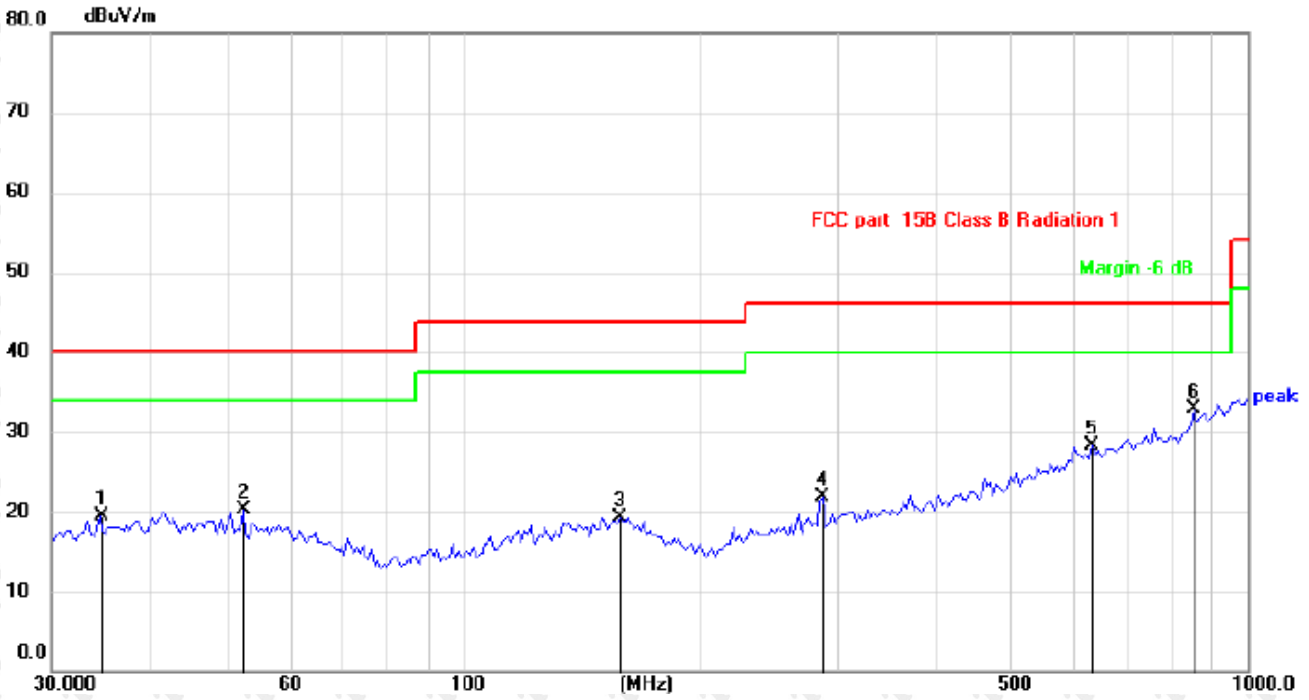

No.	Mk.	Freq. MHz	Reading Level dBuV	Correct Factor dB	Measure- ment dBuV/m	Limit dB/m	Over dB	Detector
1		34.5173	26.98	-7.39	19.59	40.00	-20.41	QP
2		52.5753	27.69	-7.30	20.39	40.00	-19.61	QP
3		158.6677	25.94	-6.64	19.30	43.50	-24.20	QP
4		287.9904	28.91	-7.08	21.83	46.00	-24.17	QP
5		633.9073	26.87	1.47	28.34	46.00	-17.66	QP
6	*	854.0247	27.54	5.30	32.84	46.00	-13.16	QP

Remark: Factor = Cable lose + Antenna factor - Pre-amplifier; Margin = Measurement - Limit

Antenna polarity: V

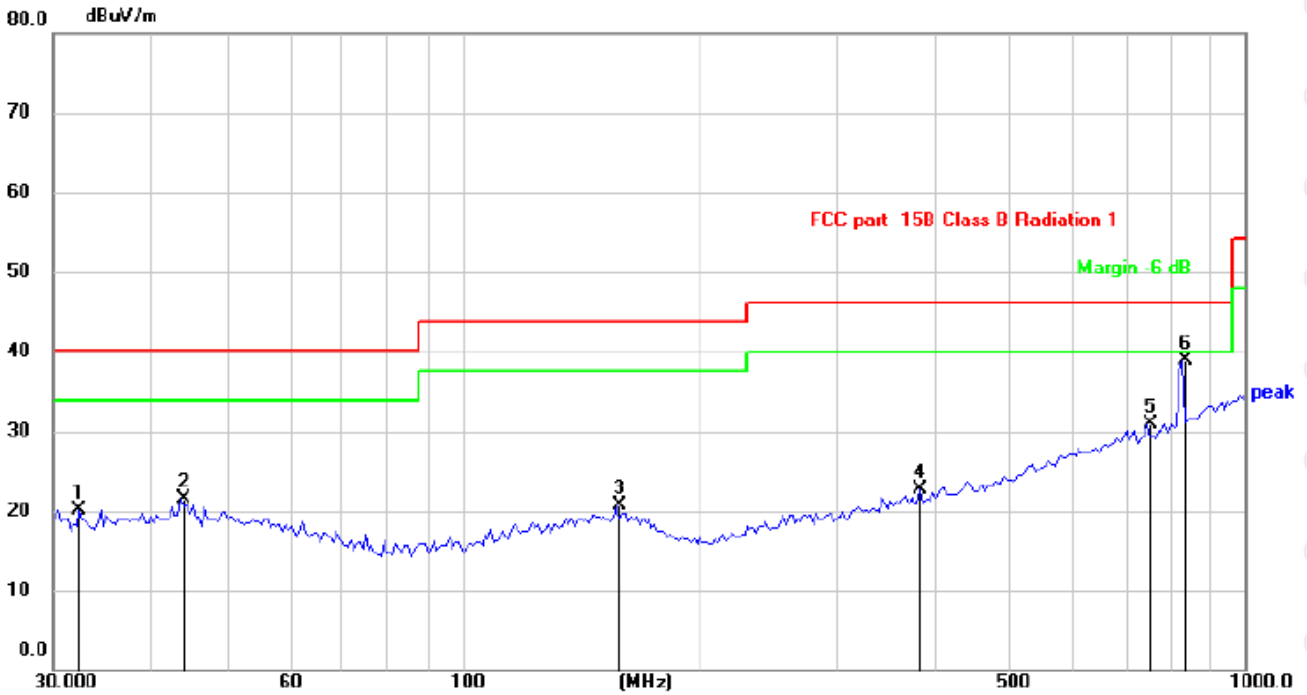

No.	Mk.	Freq. MHz	Reading Level dBuV	Correct Factor dB	Measure- ment dBuV/m	Limit dB/m	Over dB	Detector
1		32.4628	27.95	-7.84	20.11	40.00	-19.89	QP
2		43.7352	28.35	-6.89	21.46	40.00	-18.54	QP
3		157.2829	27.48	-6.70	20.78	43.50	-22.72	QP
4		384.6055	27.67	-4.98	22.69	46.00	-23.31	QP
5		748.7943	27.59	3.39	30.98	46.00	-15.02	QP
6	*	831.8574	34.08	4.77	38.85	46.00	-7.15	QP

Remark: Factor = Cable lose + Antenna factor - Pre-amplifier; Margin = Measurement - Limit

Above 1 GHz Test Results:

 CH Low (2402MHz)
 Horizontal:

Frequency	Reading Result	Factor	Emission Level	Limits	Margin	Detector Type
(MHz)	(dB μ V)	(dB)	(dB μ V/m)	(dB μ V/m)	(dB)	
4804	59.02	-3.65	55.37	74.00	-18.63	peak
4804	49.69	-3.65	46.04	54.00	-7.96	AVG
7206	61.21	-0.95	60.26	74.00	-13.74	peak
7206	40.81	-0.95	39.86	54.00	-14.14	AVG

Remark: Factor = Antenna Factor + Cable Loss – Pre-amplifier. Emission level = Reading Result + Factor, Margin = Emission level - Limits

Vertical:

Frequency	Reading Result	Factor	Emission Level	Limits	Margin	Detector Type
(MHz)	(dB μ V)	(dB)	(dB μ V/m)	(dB μ V/m)	(dB)	
4804	56.92	-3.65	53.27	74.00	-20.73	peak
4804	48.02	-3.65	44.37	54.00	-9.63	AVG
7206	59.05	-0.95	58.10	74.00	-15.90	peak
7206	41.06	-0.95	40.11	54.00	-13.89	AVG

Remark: Factor = Antenna Factor + Cable Loss – Pre-amplifier. Emission level = Reading Result + Factor, Margin = Emission level - Limits

CH Middle (2441MHz)
Horizontal:

Frequency	Reading Result	Factor	Emission Level	Limits	Margin	Detector Type
(MHz)	(dB μ V)	(dB)	(dB μ V/m)	(dB μ V/m)	(dB)	
4882.00	59.83	-3.54	56.29	74.00	-17.71	peak
4882.00	48.72	-3.54	45.18	54.00	-8.82	AVG
7323.00	58.20	-0.81	57.39	74.00	-16.61	peak
7323.00	43.44	-0.81	42.63	54.00	-11.37	AVG

Remark: Factor = Antenna Factor + Cable Loss – Pre-amplifier. Emission level = Reading Result + Factor, Margin = Emission level - Limits

Vertical:

Frequency	Reading Result	Factor	Emission Level	Limits	Margin	Detector Type
(MHz)	(dB μ V)	(dB)	(dB μ V/m)	(dB μ V/m)	(dB)	
4882.00	58.62	-3.54	55.08	74.00	-18.92	peak
4882.00	48.24	-3.54	44.70	54.00	-9.30	AVG
7323.00	57.88	-0.81	57.07	74.00	-16.93	peak
7323.00	43.69	-0.81	42.88	54.00	-11.12	AVG

Remark: Factor = Antenna Factor + Cable Loss – Pre-amplifier. Emission level = Reading Result + Factor, Margin = Emission level - Limits

CH High (2480MHz)
Horizontal:

Frequency	Reading Result	Factor	Emission Level	Limits	Margin	Detector Type
(MHz)	(dB μ V)	(dB)	(dB μ V/m)	(dB μ V/m)	(dB)	
4960	58.28	-3.43	54.85	74.00	-19.15	peak
4960	49.41	-3.44	45.97	54.00	-8.03	AVG
7440	61.12	-0.77	60.35	74.00	-13.65	peak
7440	41.11	-0.77	40.34	54.00	-13.66	AVG

Remark: Factor = Antenna Factor + Cable Loss – Pre-amplifier. Emission level = Reading Result + Factor, Margin = Emission level - Limits

Vertical:

Frequency	Reading Result	Factor	Emission Level	Limits	Margin	Detector Type
(MHz)	(dB μ V)	(dB)	(dB μ V/m)	(dB μ V/m)	(dB)	
4960	58.89	-3.43	55.46	74.00	-18.54	peak
4960	49.53	-3.44	46.09	54.00	-7.91	AVG
7440	60.33	-0.77	59.56	74.00	-14.44	peak
7440	39.90	-0.77	39.13	54.00	-14.87	AVG

Remark: Factor = Antenna Factor + Cable Loss – Pre-amplifier. Emission level = Reading Result + Factor, Margin = Emission level - Limits

Remark:

- (1) Measuring frequencies from 1 GHz to the 25 GHz .
- (2). All modes of GFSK, $\pi/4$ DQPSK were test at Low, Middle, and High channel, only the worst result of GFSK DH5 Low Channel was reported for below 1GHz test.
- (3). For BT above 1GHz test all modes of GFSK, $\pi/4$ DQPSK were test at Low, Middle, and High channel, only the worst result of GFSK DH5 was reported.
- (4). By preliminary testing and verifying three axis (X, Y and Z) position of EUT transmitted status, it was found that "Z axis" position was the worst, and test data recorded in this report.
- (5). Radiated emission test from 9kHz to 10th harmonic of fundamental was verified, and no emission found except system noise floor in 9kHz to 30MHz and not recorded in this report.
- (6).Other emissions for frequency 1GHz~25GHz are attenuated 20dB below the limit, so it does not record in report.

Restricted bands around fundamental frequency (Radiated)

hopping

Operation Mode: TX CH Low (2402MHz)

Horizontal (Worst case)

Frequency (MHz)	Meter Reading (dB μ V)	Factor (dB)	Emission Level (dB μ V/m)	Limits (dB μ V/m)	Margin (dB)	Detector Type
2310.00	57.26	-5.81	51.45	74.00	-22.55	peak
2310.00	/	-5.81	/	54.00	/	AVG
2390.00	54.97	-5.84	49.13	74.00	-24.87	peak
2390.00	/	-5.84	/	54.00	/	AVG

Remark: Factor = Antenna Factor + Cable Loss – Pre-amplifier.

Vertical:

Frequency (MHz)	Meter Reading (dB μ V)	Factor (dB)	Emission Level (dB μ V/m)	Limits (dB μ V/m)	Margin (dB)	Detector Type
2310.00	56.19	-5.81	50.38	74.00	-23.62	peak
2310.00	/	-5.81	/	54.00	/	AVG
2390.00	56.84	-5.84	51.00	74.00	-23.00	peak
2390.00	/	-5.84	/	54.00	/	AVG

Remark: Factor = Antenna Factor + Cable Loss – Pre-amplifier.

Operation Mode: TX CH High (2480MHz)
Horizontal (Worst case)

Frequency (MHz)	Meter Reading (dB μ V)	Factor (dB)	Emission Level (dB μ V/m)	Limits (dB μ V/m)	Margin (dB)	Detector Type
2483.50	54.29	-5.81	48.48	74.00	-25.52	peak
2483.50	/	-5.81	/	54.00	/	AVG
2500.00	53.26	-6.06	47.20	74.00	-26.80	peak
2500.00	/	-6.06	/	54.00	/	AVG

Remark: Factor = Antenna Factor + Cable Loss – Pre-amplifier.

Vertical:

Frequency (MHz)	Meter Reading (dB μ V)	Factor (dB)	Emission Level (dB μ V/m)	Limits (dB μ V/m)	Margin (dB)	Detector Type
2483.50	56.43	-5.81	50.62	74.00	-23.38	peak
2483.50	/	-5.81	/	54.00	/	AVG
2500.00	55.26	-6.06	49.20	74.00	-24.80	peak
2500.00	/	-6.06	/	54.00	/	AVG

Remark: Factor = Antenna Factor + Cable Loss – Pre-amplifier.

Remark: All the other emissions not reported were too low to read and deemed to comply with FCC limit.

NO hopping

Operation Mode: TX CH Low (2402MHz)
Horizontal (Worst case)

Frequency (MHz)	Meter Reading (dB μ V)	Factor (dB)	Emission Level (dB μ V/m)	Limits (dB μ V/m)	Margin (dB)	Detector Type
2310.00	54.43	-5.81	48.62	74.00	-25.38	peak
2310.00	/	-5.81	/	54.00	/	AVG
2390.00	56.02	-5.84	50.18	74.00	-23.82	peak
2390.00	/	-5.84	/	54.00	/	AVG

Remark: Factor = Antenna Factor + Cable Loss – Pre-amplifier.

Vertical:

Frequency (MHz)	Meter Reading (dB μ V)	Factor (dB)	Emission Level (dB μ V/m)	Limits (dB μ V/m)	Margin (dB)	Detector Type
2310.00	56.36	-5.81	50.55	74.00	-23.45	peak
2310.00	/	-5.81	/	54.00	/	AVG
2390.00	55.24	-5.84	49.40	74.00	-24.60	peak
2390.00	/	-5.84	/	54.00	/	AVG

Remark: Factor = Antenna Factor + Cable Loss – Pre-amplifier.

Operation Mode: TX CH High (2480MHz)
Horizontal (Worst case)

Frequency (MHz)	Meter Reading (dB μ V)	Factor (dB)	Emission Level (dB μ V/m)	Limits (dB μ V/m)	Margin (dB)	Detector Type
2483.50	56.52	-5.81	50.71	74.00	-23.29	peak
2483.50	/	-5.81	/	54.00	/	AVG
2500.00	56.45	-6.06	50.39	74.00	-23.61	peak
2500.00	/	-6.06	/	54.00	/	AVG

Remark: Factor = Antenna Factor + Cable Loss – Pre-amplifier.

Vertical:

Frequency (MHz)	Meter Reading (dB μ V)	Factor (dB)	Emission Level (dB μ V/m)	Limits (dB μ V/m)	Margin (dB)	Detector Type
2483.50	55.29	-5.81	49.48	74.00	-24.52	peak
2483.50	/	-5.81	/	54.00	/	AVG
2500.00	54.71	-6.06	48.65	74.00	-25.35	peak
2500.00	/	-6.06	/	54.00	/	AVG

Remark: Factor = Antenna Factor + Cable Loss – Pre-amplifier.

Remark: All the other emissions not reported were too low to read and deemed to comply with FCC limit.

8. BAND EDGE AND RF CONDUCTED SPURIOUS EMISSIONS

8.1 Block Diagram Of Test Setup

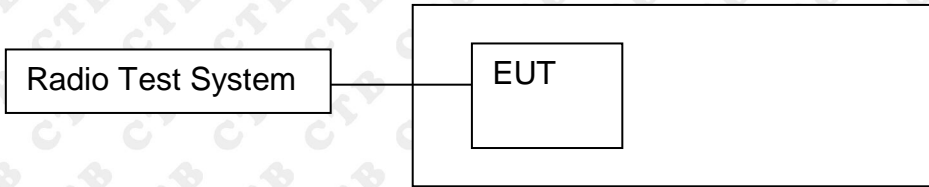

8.2 Limit

In any 100 kHz bandwidth outside the frequency band in which the spread spectrum or digitally modulated intentional radiator is operating, the radio frequency power that is produced by the intentional radiator shall be at least 20 dB below that in the 100 kHz bandwidth within the band that contains the highest level of the desired power, based on either an RF conducted or a radiated measurement, provided the transmitter demonstrates compliance with the peak conducted power limits. If the transmitter complies with the conducted power limits based on the use of RMS averaging over a time interval, as permitted under paragraph (b)(3) of this section, the attenuation required under this paragraph shall be 30 dB instead of 20 dB. Attenuation below the general limits specified in §15.209(a) is not required. In addition, radiated emissions which fall in the restricted bands, as defined in §15.205(a), must also comply with the radiated emission limits specified in §15.209(a) (see §15.205(c)).

8.3 Test procedure

1. Remove the antenna from the EUT and then connect a low RF cable from the antenna port to the spectrum;

2. Set the spectrum analyzer:

Below 30MHz:

RBW = 100kHz, VBW = 300kHz, Sweep = auto

Detector function = peak, Trace = max hold

Above 30MHz:

RBW = 100KHz, VBW = 300KHz, Sweep = auto

Detector function = peak, Trace = max hold

Test from 30MHz to 25GHz, only worse case 30MHz to 12.75GHz is reported, no emission found above 12.75GHz.

8.4 Test Result

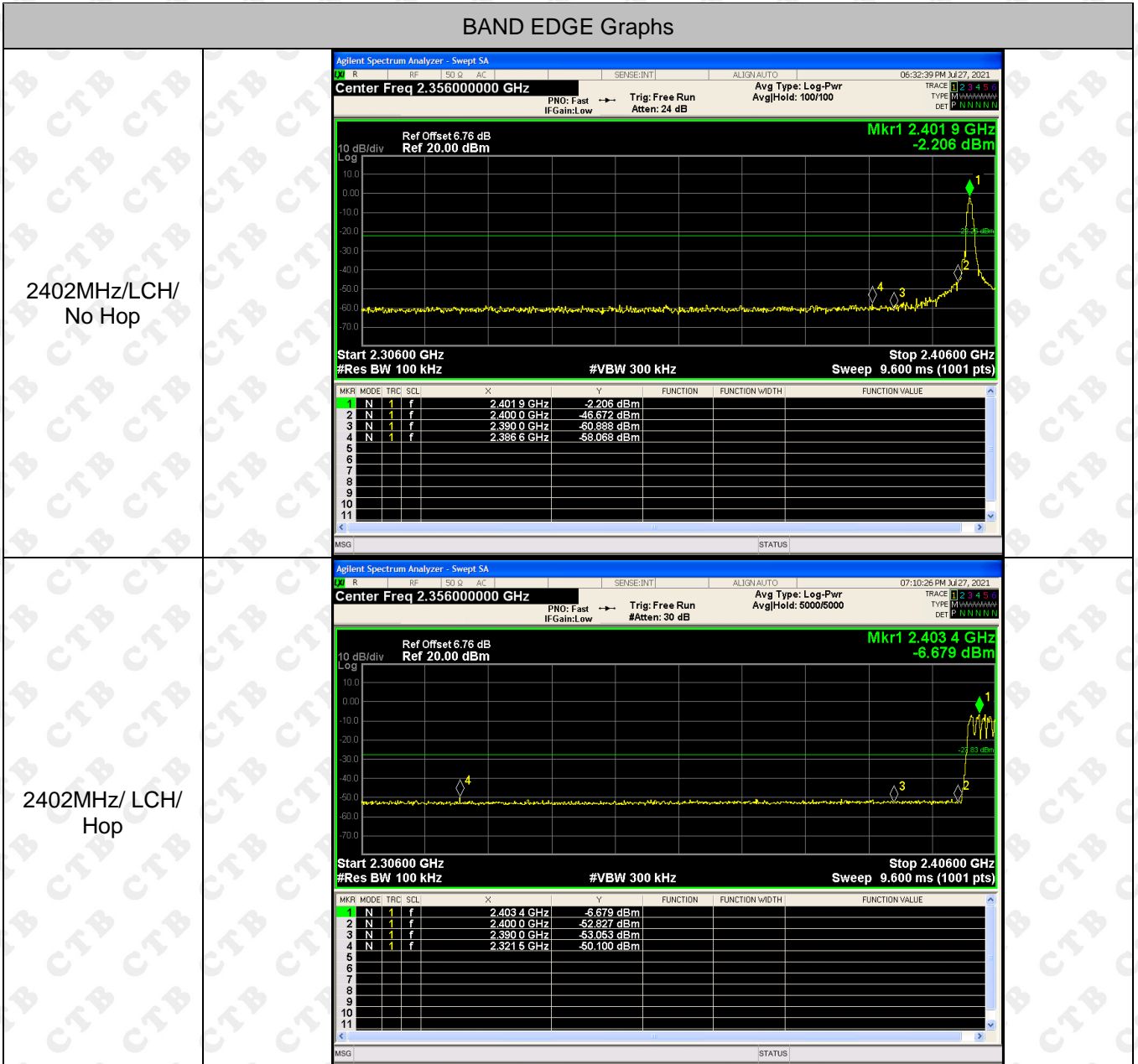



RF Conducted Spurious Emissions Graphs

2402MHz/LCH

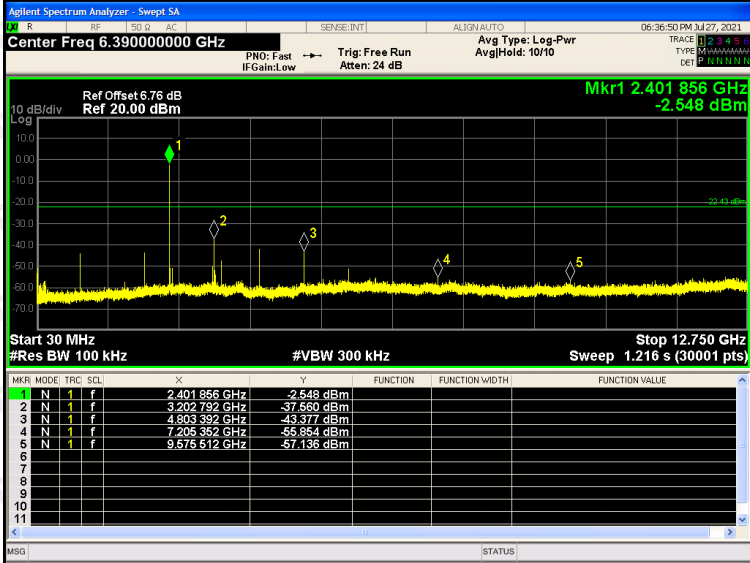

2441MHz/MCH

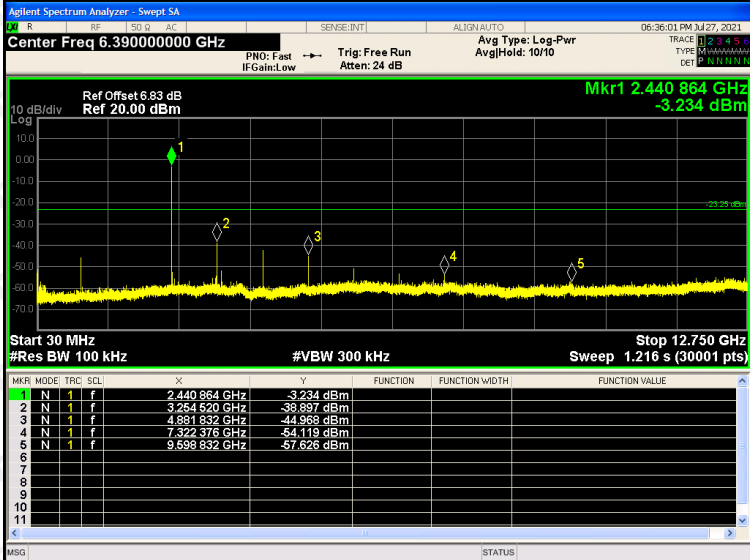

2480MHz/HCH

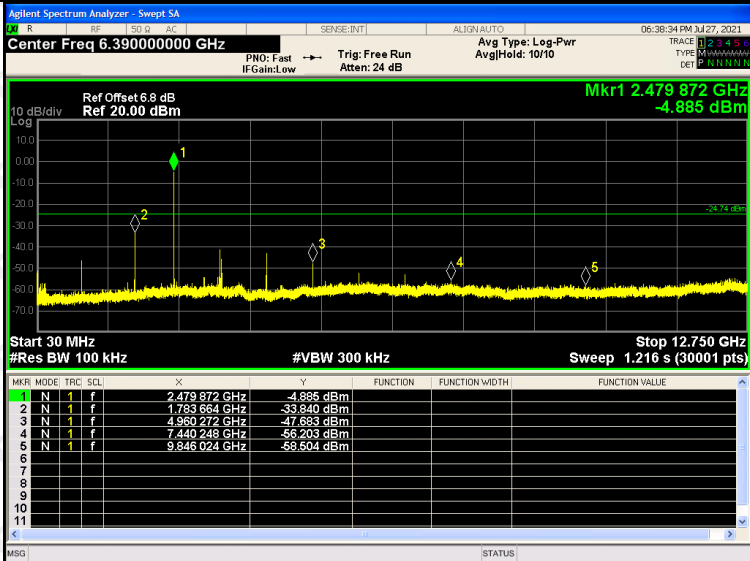

9. COUDUCTED PEAK OUTPUT POWER

9.1 Block Diagram Of Test Setup

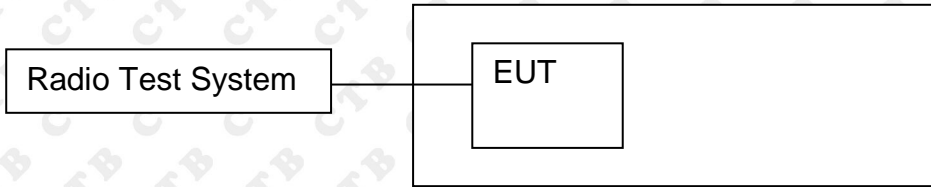

9.2 Limit

For frequency hopping systems operating in the 2400-2483.5 MHz band employing at least 75 non-overlapping hopping channels, and all frequency hopping systems in the 5725-5850 MHz band: 1 watt. For all other frequency hopping systems in the 2400-2483.5 MHz band: 0.125 watts.

9.3 Test procedure

1. Remove the antenna from the EUT and then connect a low RF cable from the antenna port to the spectrum.
2. Set the spectrum analyzer: RBW = 3MHz. VBW = 8MHz. Sweep = auto; Detector Function = Peak.
3. Keep the EUT in transmitting at lowest, middle and highest channel individually. Record the max value.

9.4 Test Result

Frequency (MHz)	Channel.	Maximum Peak Output Power [dBm]	Verdict
2402	Normal	-1.235	PASS
2441	Normal	0.013	PASS
2480	Normal	-1.572	PASS

Test Graph:

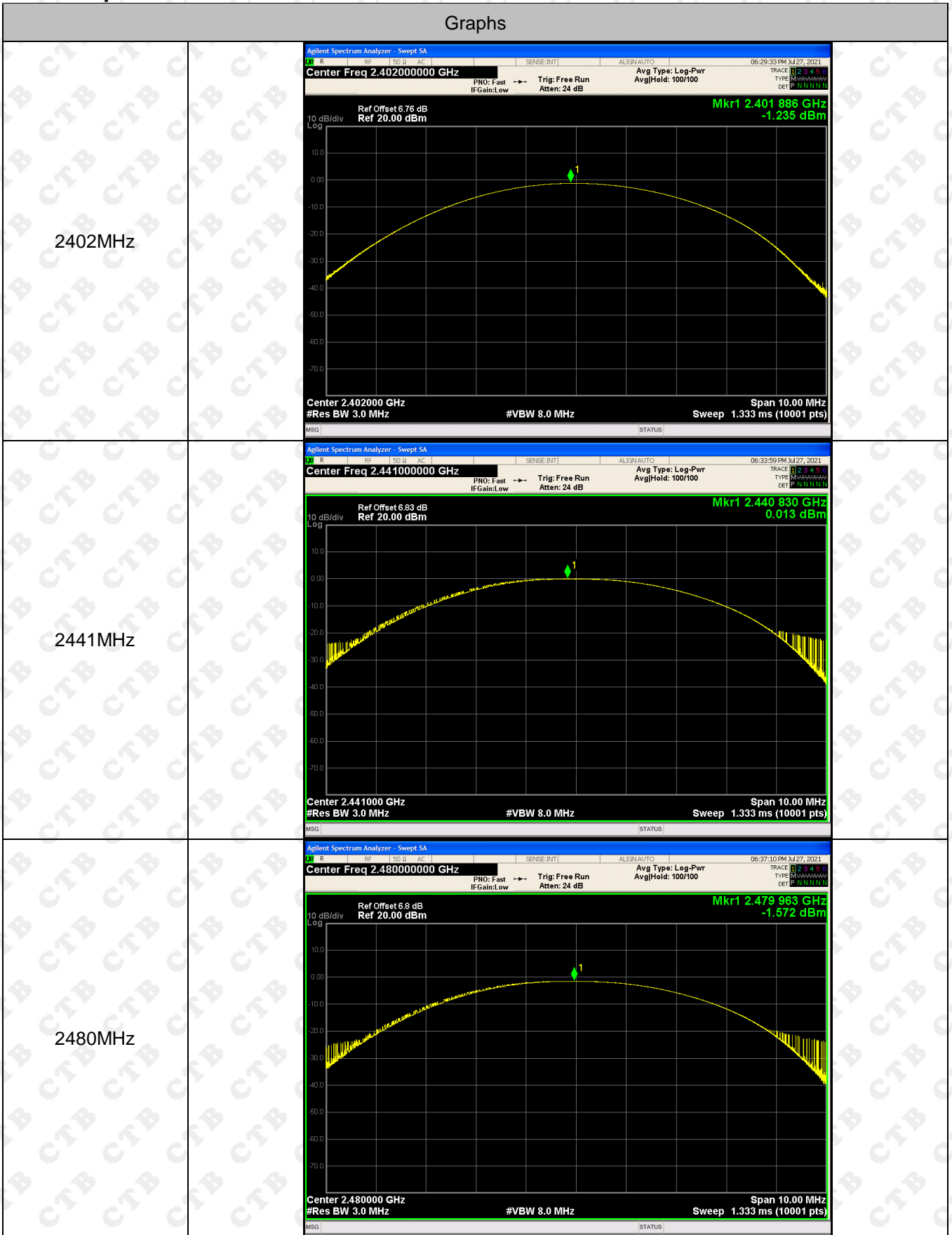

10. 20DB OCCUPIED BANDWIDTH

10.1 Block Diagram Of Test Setup

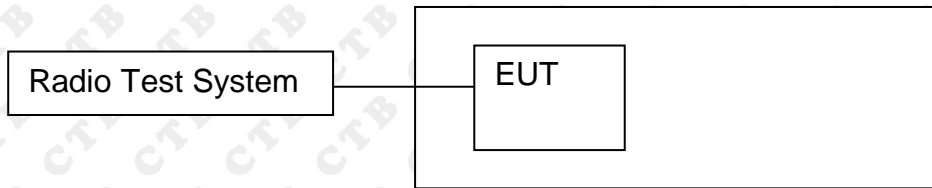

10.2 Limit

Alternatively, frequency hopping systems operating in the 2400-2483.5MHz band may have hopping channel carrier frequencies that are separated by 25kHz or two-thirds of the 20dB bandwidth of the hopping channel, whichever is greater, provided the systems operate with an output power no greater than 125mw.

10.3 Test procedure

1. Rem1. Set RBW = 30 kHz.
2. Set the video bandwidth (VBW) $\geq 3 \times$ RBW.
3. Detector = Peak.
4. Trace mode = max hold.
5. Sweep = auto couple.
6. Allow the trace to stabilize.
7. Measure the maximum width of the emission that is constrained by the frequencies associated with the two outermost amplitude points (upper and lower frequencies) that are attenuated by 6 dB relative to the maximum level measured in the fundamental emission.

10.4 Test Result

Frequency	Channel.	20dB Bandwidth (MHz)	Result
2402MHz	Normal	1.1	PASS
2441MHz	Normal	1.097	PASS
2480MHz	Normal	1.096	PASS

Note: All modes of operation were Pre-scan and the worst-case emissions are reported.

Test Graph:

<p>2402MHz</p>		<p>Agilent Spectrum Analyzer - Occupied BW Center Freq 2.40200000 GHz Center Freq: 2.40200000 GHz Trig: Free Run AvgHold: 100/100 Radio Std: None Radio Device: BTS</p> <p>Ref Offset 6.76 dB Ref 26.76 dBm Mkr3 2.402533 GHz -23.791 dBm</p> <p>Center 2.402 GHz #Res BW 30 kHz #VBW 100 kHz Span 2 MHz Sweep 2.667 ms</p> <p>Occupied Bandwidth 1.0771 MHz Total Power 3.17 dBm Transmit Freq Error -16.942 kHz OBW Power 99.00 % x dB Bandwidth 1.100 MHz x dB -20.00 dB</p>	
<p>2441MHz</p>		<p>Agilent Spectrum Analyzer - Occupied BW Center Freq 2.44100000 GHz Center Freq: 2.44100000 GHz Trig: Free Run AvgHold: 100/100 Radio Std: None Radio Device: BTS</p> <p>Ref Offset 6.83 dB Ref 26.83 dBm Mkr3 2.441536 GHz -24.897 dBm</p> <p>Center 2.441 GHz #Res BW 30 kHz #VBW 100 kHz Span 2 MHz Sweep 2.667 ms</p> <p>Occupied Bandwidth 1.0844 MHz Total Power 2.27 dBm Transmit Freq Error -12.777 kHz OBW Power 99.00 % x dB Bandwidth 1.097 MHz x dB -20.00 dB</p>	
<p>2480MHz</p>		<p>Agilent Spectrum Analyzer - Occupied BW Center Freq 2.48000000 GHz Center Freq: 2.48000000 GHz Trig: Free Run AvgHold: 100/100 Radio Std: None Radio Device: BTS</p> <p>Ref Offset 6.8 dB Ref 26.80 dBm Mkr3 2.480542 GHz -26.948 dBm</p> <p>Center 2.48 GHz #Res BW 30 kHz #VBW 100 kHz Span 2 MHz Sweep 2.667 ms</p> <p>Occupied Bandwidth 1.0815 MHz Total Power 0.58 dBm Transmit Freq Error -6.254 kHz OBW Power 99.00 % x dB Bandwidth 1.096 MHz x dB -20.00 dB</p>	

11. CARRIER FREQUENCIES SEPARATION

11.1 Block Diagram Of Test Setup

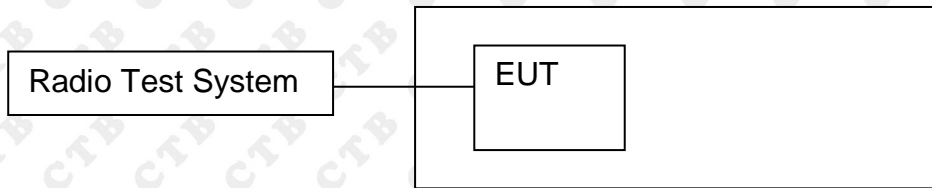

11.2 Limit

Frequency hopping systems shall have hopping channel carrier frequencies separated by a minimum of 25 kHz or the 20 dB bandwidth of the hopping channel, whichever is greater. Alternatively, frequency hopping systems operating in the 2400-2483.5 MHz band may have hopping channel carrier frequencies that are separated by 25 kHz or two-thirds of the 20 dB bandwidth of the hopping channel, whichever is greater, provided the systems operate with an output power no greater than 0.125W.

11.3 Test procedure

1. Remove the antenna from the EUT and then connect a low RF cable from the antenna port to the spectrum.
2. Set the spectrum analyzer: RBW = 30kHz. VBW = 100kHz , Span = 3.0MHz. Sweep = auto; Detector Function = Peak. Trace = Max hold.
3. Allow the trace to stabilize. Use the marker-delta function to determine the separation between the peaks of the adjacent channels. The limit is specified in one of the subparagraphs of this Section Submit this plot.

11.4 Test Result

Frequency (MHz)	Channel.	Carrier Frequency Separation [MHz]	Verdict
2402MHz	Normal	1.002	PASS
2441MHz	Normal	0.999	PASS
2480MHz	Normal	0.999	PASS

Test Graph



12. HOPPING CHANNEL NUMBER

12.1 Block Diagram Of Test Setup

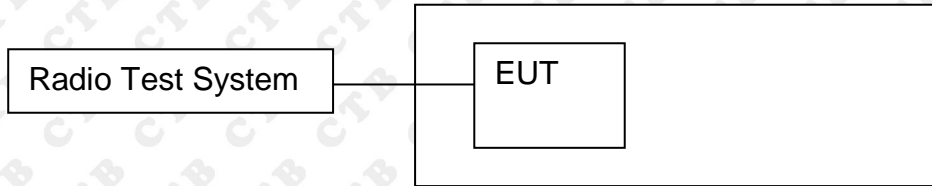

12.2 Limit

Frequency hopping systems in the 2400-2483.5 MHz band shall use at least 15 channels.

12.3 Test procedure

1. Remove the antenna from the EUT and then connect a low RF cable from the antenna port to the spectrum.
2. Set the spectrum analyzer: RBW = 100kHz. VBW = 300kHz. Sweep = auto; Detector Function = Peak. Trace = Max hold.
3. Allow the trace to stabilize. It may prove necessary to break the span up to sections. in order to clearly show all of the hopping frequencies. The limit is specified in one of the subparagraphs of this Section.
4. Set the spectrum analyzer: Start Frequency = 2.4GHz, Stop Frequency = 2.4835GHz. Sweep=auto;

12.4 Test Result

Frequency (MHz)	Channel.	Number of Hopping Channel	Verdict
2402MHz	Hop	79	PASS

Test Graph

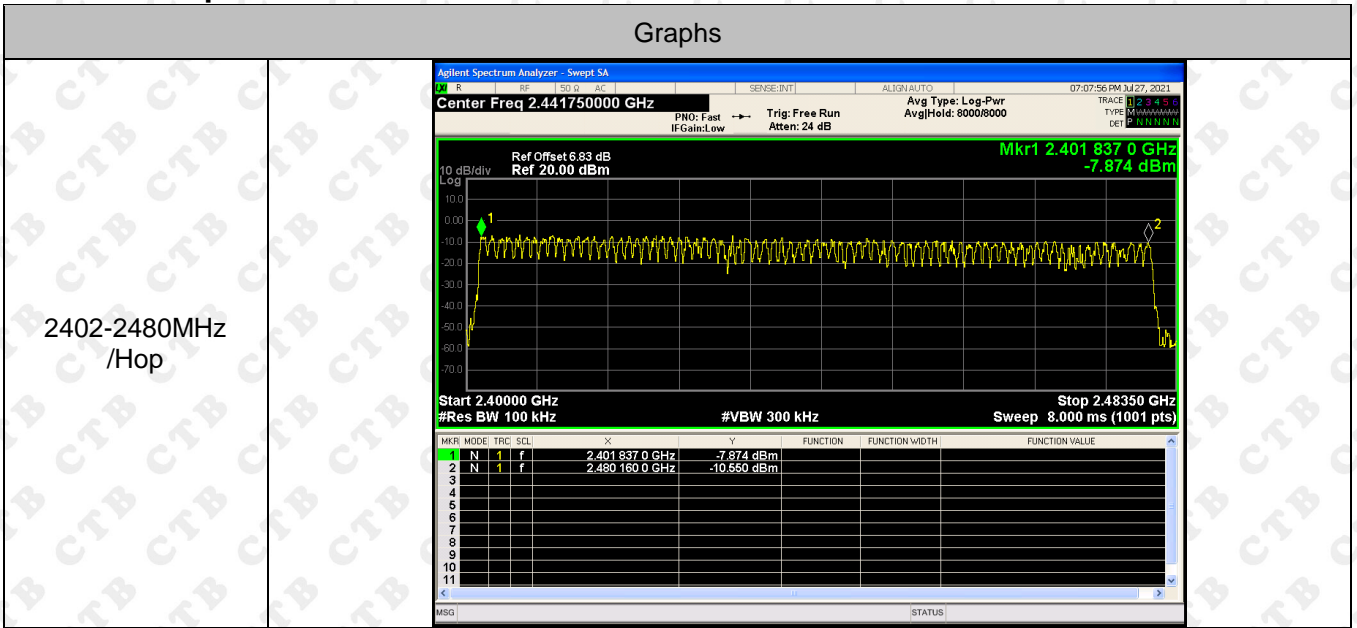

13. DWELL TIME

13.1 Block Diagram Of Test Setup

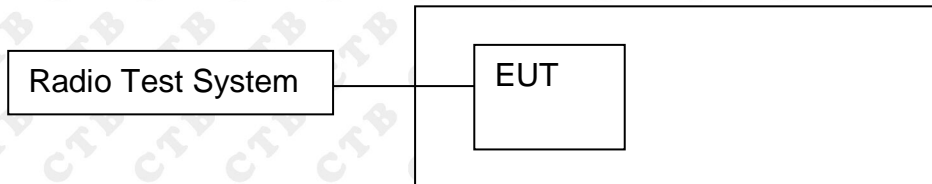

13.2 Limit

Frequency hopping systems in the 2400-2483.5 MHz band shall use at least 15 channels. The average time of occupancy on any channel shall not be greater than 0.4 seconds within a period of 0.4 seconds multiplied by the number of hopping channels employed. Frequency hopping systems may avoid or suppress transmissions on a particular hopping frequency provided that a minimum of 15 channels are used.

13.3 Test procedure

1. Remove the antenna from the EUT and then connect a low RF cable from the antenna port to the spectrum.
2. Set spectrum analyzer span = 0. Centred on a hopping channel;
3. Set RBW = 1MHz and VBW = 3MHz. Sweep = as necessary to capture the entire dwell time per hopping channel. Set the EUT for DH1 packet transmitting.
4. Use the marker-delta function to determine the dwell time. If this value varies with different modes of operation (e.g., data rate, modulation format, etc.), repeat this test for each variation. The limit is specified in one of the subparagraphs of this Section. Submit this plot(s).

13.4 Test Result

Frequency (MHz)	Channel	Pulse Time (ms)	Total Dwell Time (ms)	Limit (ms)	Verdict
2402	Normal	0.432	138.24	400	PASS
2441	Normal	0.433	138.56	400	PASS
2480	Normal	0.433	138.56	400	PASS

Remark: DH1 Packet permit maximum 1600 / 79 / 2 hops per second in each channel (1 time slot RX, 1 time slot TX). So, the Dwell Time can be calculated as follows:

DH1: $1600/79/2 * 0.4 * 79 * \text{MkrDelta ms}$

Remark: Mkr Delta is once pulse time.

Test Graph



14. PSEUDORANDOM FREQUENCY

14.1 Limit

Frequency hopping systems shall have hopping channel carrier frequencies separated by a minimum of 25 kHz or the 20 dB bandwidth of the hopping channel, whichever is greater. Alternatively, Frequency hopping systems operating in the 2400-2483.5 MHz band may have hopping channel carrier frequencies that are separated by 25 kHz or two-thirds of the 20 dB bandwidth of the hopping channel, whichever is greater, provided the systems operate with an output power no greater than 125 mW. The system shall hop to channel frequencies that are selected at the system hopping rate from a Pseudorandom ordered list of hopping frequencies. Each frequency must be used equally on the average by each transmitter. The system receivers shall have input bandwidths that match the hopping channel bandwidths of their corresponding transmitters and shall shift frequencies in synchronization with the transmitted signals.

14.2 Test procedure

The pseudorandom sequence may be generated in a nine-stage shift register whose 5th and 9th stage outputs are added in a modulo-two addition stage. And the result is fed back to the input of the first stage. The sequence begins with the first ONE of 9 consecutive ONES; i.e. the shift register is initialized with nine ones.

- Number of shift register stages: 9
- Length of pseudo-random sequence: $2^9 - 1 = 511$ bits
- Longest sequence of zeros: 8 (non-inverted signal)

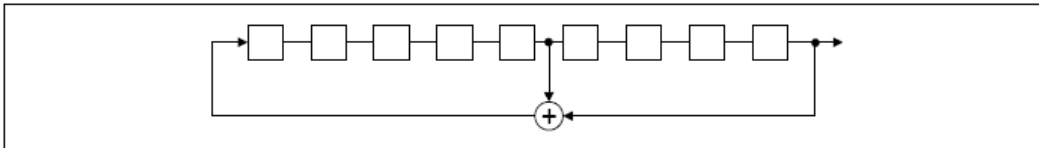

An example of Pseudorandom Frequency Hopping Sequence as follow:

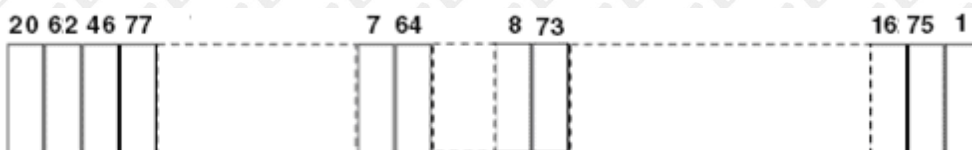

Each frequency used equally on the average by each transmitter. The system receivers have input bandwidths that match the hopping channel bandwidths of their corresponding transmitters and shift frequencies in synchronization with the transmitted signals.

14.3 Test Result

The device does not have the ability to be coordinated with other FHSS systems in an effort to avoid the simultaneous occupancy of individual hopping frequencies by multiple transmitters.

15. ANTENNA REQUIREMENT

15.203 requirement:

An intentional radiator shall be designed to ensure that no antenna other than that furnished by the responsible party shall be used with the device. The use of a permanently attached antenna or of an antenna that uses a unique coupling to the intentional radiator, the manufacturer may design the unit so that a broken antenna can be replaced by the user, but the use of a standard antenna jack or electrical connector is prohibited.

15.247(b) (4) requirement:

The conducted output power limit specified in paragraph (b) of this section is based on the use of antennas with directional gains that do not exceed 6 dBi. Except as shown in paragraph (c) of this section, if transmitting antennas of directional gain greater than 6 dBi are used, the conducted output power from the intentional radiator shall be reduced below the stated values in paragraphs (b)(1), (b)(2), and (b)(3) of this section, as appropriate, by the amount in dB that the directional gain of the antenna exceeds 6 dBi.

EUT Antenna:

The antenna is PCB antenna. The best case gain of the antenna is 2.34dBi.

16. EUT PHOTOGRAPHS

EUT Photo 1



EUT Photo 2

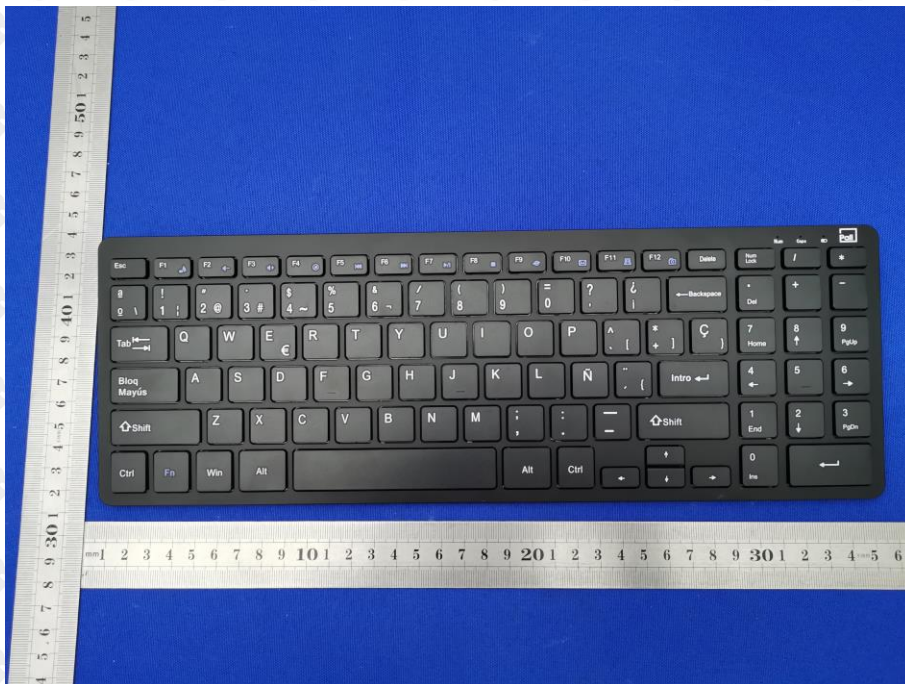

EUT Photo 3



EUT Photo 4



EUT Photo 5



EUT Photo 6



EUT Photo 7



17. EUT TEST SETUP PHOTOGRAPHS

Radiated Emission

Below 1G



Above 1G



Conducted emissions



***** END OF REPORT *****