



AGM ASP-MICRO TM160i
AGM TAIPAN TM10-256i
AGM TAIPAN TM15-256i

THERMAL IMAGING MONOCULAR

Table of Contents

Chapter 1 Overview	1
1.1 Brief Description	1
1.2 Function	1
1.3 Appearance	2
1.3.1 Button	2
1.3.2 Component	3
Chapter 2 Preparation	4
2.1 Charge Device	4
2.2 Power On/Off	5
2.3 Menu Description	5
2.3.1 Main Menu	5
2.3.2 Quick Menu	6
2.4 Firmware Status	7
2.4.1 Client Software Connection	7
2.4.2 Check Firmware Status	7
2.4.3 Upgrade Device	8
Chapter 3 Image Settings	9
3.1 Adjust Diopter	9
3.2 Adjust Focus	10
3.3 Adjust Image Brightness	11
3.4 Adjust Contrast	11
3.5 Adjust Tone	11
3.6 Adjust Sharpness	11
3.7 Select Scene	12
3.8 Set Palettes	12
3.9 Adjust Digital Zoom	14
3.10 Set Picture in Picture Mode	14
3.11 Flat Field Correction	14
3.12 Correct Defective Pixel	15

Chapter 4 Measure Distance	17
Chapter 5 General Settings.....	18
5.1 Set OSD	18
5.2 Set Display Brightness.....	18
5.3 Burning Prevention	18
5.4 Capture and Video	19
5.4.1 Capture Picture	19
5.4.2 Record Video	19
5.5 Hot Tracking.....	20
5.6 Export Files	20
5.6.1 Export Files via T-Vision	20
5.6.2 Export Files via PC	21
Chapter 6 System Settings.....	23
6.1 Date Adjustment.....	23
6.2 Synchronize Time.....	23
6.3 Language Settings	23
6.4 Unit Settings	24
6.5 CVBS Output	24
6.6 View Device Information	24
6.7 Restore Device	25
Chapter 7 Frequently Asked Questions	26
7.1 Why does the charge indicator flash improperly?	26
7.2 Why is the power indicator off?	26
7.3 The image is not clear, how to adjust it?	26
7.4 Capturing or recording fails. What's the problem?.....	26
7.5 Why the PC cannot identify the device?	26
Safety Instruction	27
Legal Information	29
Regulatory Information	30

Chapter 1 Overview

1.1 Brief Description

The thermal monocular supports functions of observation, distance measurement, hotspot, and so on. The high-sensitivity built-in thermal detector provides you with clear view even in total darkness. The monocular is mainly applied to scenarios such as hunting, searching and rescuing, hiking, and travel.

1.2 Function

Distance Measurement

The device can detect the distance between the target and the observation position.

Hot Tracking

The device can detect the highest temperature in the scene and mark the spot. This function varies according to different camera models.

Large Digital Zoom

Digital zoom up to 8 × offers better focus on small target from a far distance.

Image Correction

The device supports DPC (Defective Pixel Correction) and FFC (Flat Field Correction) which can optimize the image quality.

Client Software Connection

The device can capture snapshots, record videos, and set parameters by T-Vision App after being connected to your phone via hot spot.

Storage

The built-in memory module supports video recording and snapshot capturing.

1.3 Appearance

1.3.1 Button

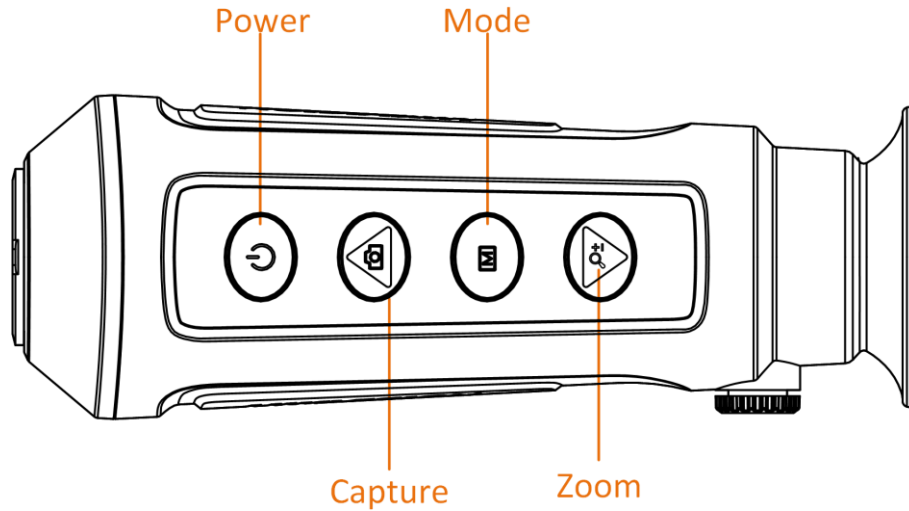





Figure 1-1 Buttons on the Device

Table 1-1 Function of Button

Icon	Button	Function
	Power	<ul style="list-style-type: none"> ● Press: Standby mode/Wake up device ● Hold: Power on/off
	Capture	Non-Menu Mode: <ul style="list-style-type: none"> ● Press: Capture pictures ● Hold: Start/stop recording Menu Mode: Press to move up.
	Mode	Non-Menu Mode: <ul style="list-style-type: none"> ● Press: Enter the quick menu ● Hold: Enter the main menu Menu Mode: <ul style="list-style-type: none"> ● Press: Confirm/set parameters ● Hold: Save and exit settings
	Zoom	Non-Menu Mode: <ul style="list-style-type: none"> ● Press: Switch digital zoom ● Hold: Correct non-uniformity of display (FFC) Menu Mode: Press to move down.

1.3.2 Component

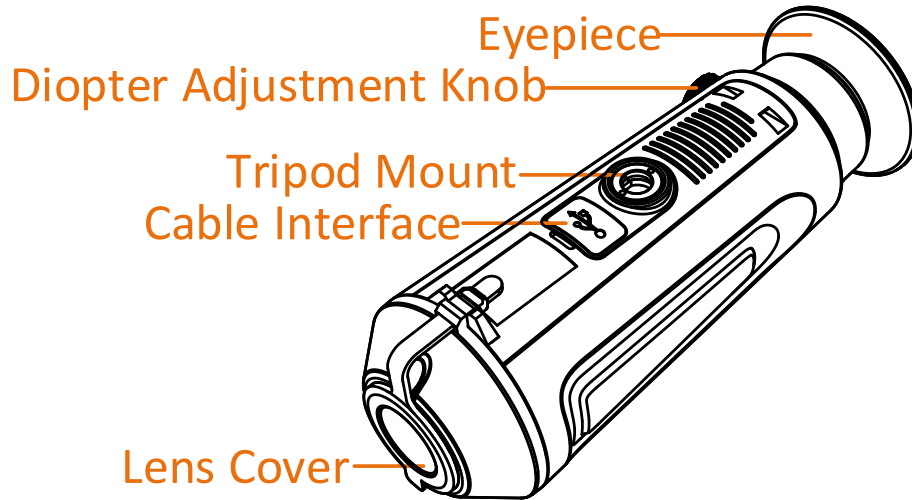

Figure 1-2 Overview of Component

- Lens Cover: Protects the lens from dust or scratch.
- Diopter Adjustment Knob: Adjusts the dioptic setting.
- Cable Interface: To connect the device to power supply or transmit data with a type-C cable.
- Tripod Mount: Mounts the tripod.
- Eyepiece: The piece placed closest to the eye to view the target.

Chapter 2 Preparation

Take out the device and accessories. Check them with the packaging list to confirm device and accessories are included and available for use. Read the user manual to learn the usage methods and cautions.

2.1 Charge Device

After the device starts up, the OSD (on-screen display) shows the battery status. When the battery is low, charge the device and ensure it works properly.

Before You Start

- The charging temperature should be from 0 °C to 45 °C (32 °F to 113 °F).
- Charge the device with the delivered cable.

Steps

1. Lift the cable interface cover.
2. Plug in the cable and charge the device.

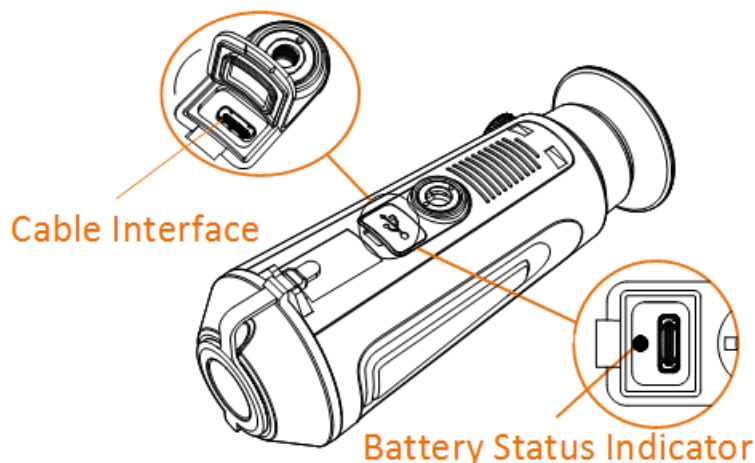

Figure 2-1 Cable Interface

- Flashing Red & Green: error occurred.
- Solid Red: battery is properly charged.
- Solid Green: battery is fully charged.
- Off: battery is not charged.

Note

- Charge the device for more than 5 hours before first use.
 - The built-in battery type is 18650, and the battery size should be 24 mm × 72 mm. The rated voltage and capacity are 3.635 VDC/3350 mAh.
-

2.2 Power On/Off

Power On

When the device is connected to cable or the battery is enough, hold  for 2 seconds to power on the device.

Power Off

When the device is turned on, hold  for 2 seconds to power off the device.







Note

- Power-off countdown will appear when you power off the device. You can press any key to interrupt the countdown and cancel the power-off.
 - Automatic low battery power-off cannot be canceled.
-



Auto Power Off

You can set the auto power off time for your device.

Steps

1. Hold  to go to the main menu.
 2. Go to select  **General Settings**, and select .
 3. Press  or  to select the auto power off time as required, and press  to confirm.
 4. Hold  to save and exit.
-

Note

- See the battery icon for the battery status.  means the battery is fully charged,  means that the battery is low, and  means the battery charging is abnormal.
 - When the low power note shows, charge the battery.
 - The auto power off countdown will start again when the device exits standby mode or the device is restarted.
-

2.3 Menu Description

2.3.1 Main Menu

When the device powers on, hold  to enter or exit the main menu.

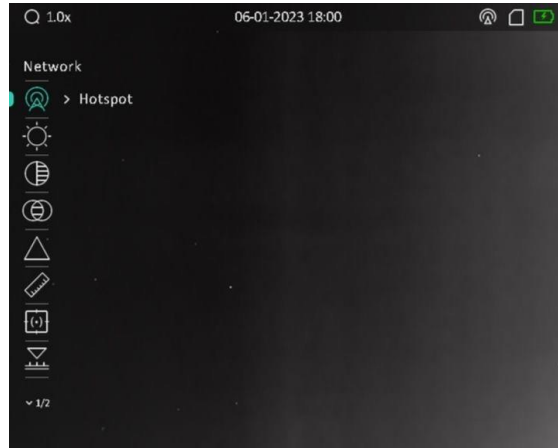





Figure 2-2 Menu Description

- Press  to move the cursor up.
- Press  to move the cursor down.
- Press  to confirm and hold it to exit the main menu.

2.3.2 Quick Menu

In the live view interface, press  to show the quick menu. You can switch palettes, set PIP mode, and adjust display brightness in the quick menu.



Figure 2-3 Quick Menu

Note





Display brightness function varies according to different camera models.

2.4 Firmware Status

2.4.1 Client Software Connection

Connect the device to the T-Vision APP via hot spot, then you can capture picture, record video, or configure parameters on your phone.

Steps

1. Hold  to show the main menu of device.
2. Press  or  to select , and press  to enable hotspot function.
3. Turn on the WLAN of your phone and connect to the hot spot.
 - Hot Spot Name: Wlan-Serial No.
 - Hot Spot Password: Serial No.
4. Search the T-Vision on App Store (iOS System) or Google Play™ (Android System) to download it, or scan the QR code to download and install the app.



Android System



iOS System

5. Open the App and connect your phone with the device. You can view the interface of device on your phone.

Note

- The device cannot connect to the App if you enter wrong password several times. Reset the device, and connect the App again.
 - The device should be activated for the first use. The default password must be changed after the activation.
-

2.4.2 Check Firmware Status

Steps

1. Open the T-Vision App and connect your device to the app.
2. Check if there is  on the right side of **Device Upgrade** in the setting interface. If there is no arrow, the firmware is the latest version. Otherwise, the firmware is not the latest version.

Device Upgrade



Figure 2-4 Check Firmware Status

3. (Optional) If the firmware is not the latest version, upgrade the device. See **2.4.3 Upgrade Device**.

2.4.3 Upgrade Device

Upgrade Device via T-Vision App

Before You Start

Install T-Vision App on your phone and connect your device to the app.

Steps

1. Tap  to enter the device setting interface.
2. Tap **Device Upgrade** and switch the network first.
3. Confirm to download the upgrade package.
4. After the upgrade package is downloaded, log in to the device again to upgrade the device.



The upgrading operation may vary due to app updates. Please take the actual app version for reference.

Upgrade Device via PC

Before You Start

Please get the upgrade package first.

Steps

1. Connect the device to your PC with cable.
2. Open the detected disk, copy the upgrade file and paste it to the root directory of the device.
3. Disconnect the device from your PC.
4. Reboot the device.

Result

The device upgrades automatically. The upgrading process will be displayed in the main interface.

Chapter 3 Image Settings

You can set palettes, brightness, scenes, FFC (flat field correction), and DPC (defective pixel correction) to display the better image effect.

3.1 Adjust Diopter

Make sure the eyepiece covers your eye and aim at the target. Adjust the diopter adjustment knob until the OSD text or image is clear.

 **Note**

When adjusting diopter, DO NOT touch the surface of lens to avoid smearing the lens.

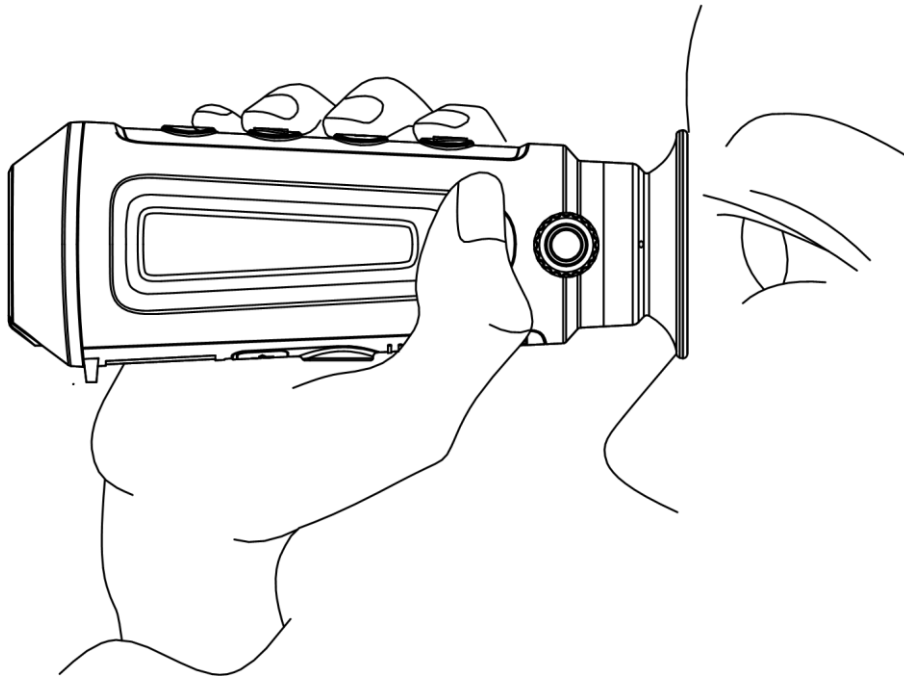

Figure 3-1 View the Target

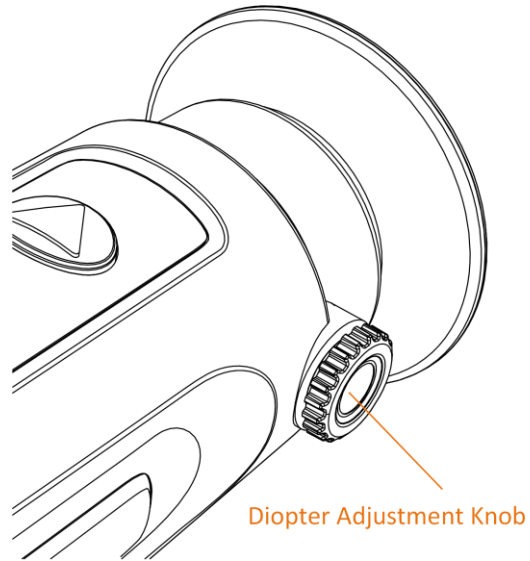

Figure 3-2 Adjust Diopter

3.2 Adjust Focus

Slightly rotate the focus ring to adjust the focus of the objective lens.

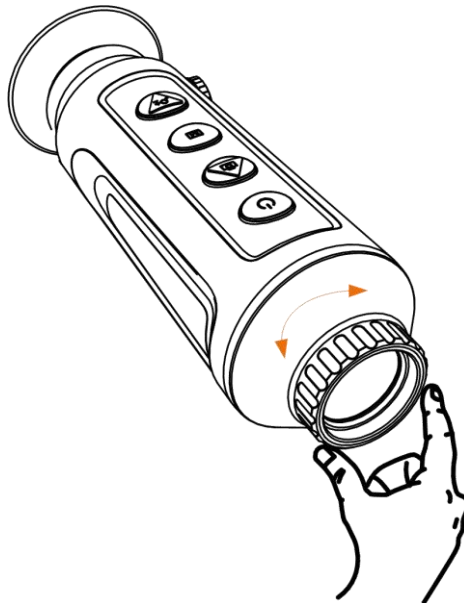







Figure 3-3 Adjust Objective Lens

 **Note**

- DO NOT touch the lens directly with your finger, or place any sharp objects near them.
 - This function varies according to different camera models.
-

3.3 Adjust Image Brightness

Steps

1. In the main menu, select  and press  to confirm.
2. Press  or  to adjust image brightness.
3. Hold  to save and exit.





In white hot mode, the higher the value of brightness is, the brighter the image is. The image effect in white hot mode is showed as picture below and effect in black hot mode is opposite.



Figure 3-4 Adjust Brightness in White Hot Mode





3.4 Adjust Contrast

Steps

1. In the main menu, select  and press  to confirm.
2. Press  or  to adjust contrast.
3. Hold  to save and exit.





3.5 Adjust Tone

Steps

1. In the main menu, select  and press  to confirm.
2. Press  or  to select a tone. **Warm** and **Cold** can be selected.
3. Hold  to save and exit.

3.6 Adjust Sharpness







Steps

1. In the main menu, select  and press  to confirm.
2. Press  or  to adjust sharpness.
3. Hold  to save and exit.

3.7 Select Scene

You can select proper scene according to actual using scene to improve the display effect.





Steps

1. Hold  to go to the main menu.
2. Select  and press  to enter the setting interface.
3. Press  or  to switch scene.
 - **Recognition:** Recognition refers to recognition mode and is recommended in normal scene.
 - **Jungle:** Jungle refers to jungle mode and is recommended in hunting environment.
4. Hold  to save settings and exit.

3.8 Set Palettes

You can select different palettes to display the same scene in different effects.

Steps

1. In the quick menu, select  and press  to enter the setting interface.
2. Press  or  to switch palettes.
3. Hold  to save and exit.

White Hot

The hot part is light-colored in view. The higher the temperature is, the lighter the color is.



Black Hot

The hot part is black-colored in view. The higher the temperature is, the darker the color is.



Red Hot

The hot part is red-colored in view. The higher the temperature is, the redder the color is.



Fusion

From high temperature to low temperature, the image is colored in from white, yellow, red, pink to purple.



3.9 Adjust Digital Zoom

You can zoom the image by using this function.

Press  in the view mode, the live view switches between 1 ×, 2 ×, 4 ×, and 8 ×.

Note

This function varies according to different camera models.

3.10 Set Picture in Picture Mode

Steps





1. In the live view interface, press  to go to the quick menu.
2. Select , and press  to enable or disable PIP mode. The details show in the upper center of the view.
3. Hold  to save the settings and exit.



Figure 3-5 Set Picture in Picture Mode



Note







If digital zoom is enabled, only the PIP view zooms.

3.11 Flat Field Correction

This function can correct non-uniformity of display.

Steps

1. Hold  to go to the main menu.
2. Go to  **Function Settings**, and select .

3. Press  to enter the setting interface.
 4. Press  or  to switch FFC mode.
 - **Manual:** Hold  in live view to correct the non-uniformity of display.
 - **Auto:** The device performs FFC automatically according to the set schedule when switching on the camera.
 - **External:** Cover the lens cover, then hold  in live view to correct the non-uniformity of display.
 5. Hold  to save the settings and exit.
-

















Note

The countdown will start before the device performs FFC automatically.

3.12 Correct Defective Pixel

The device can correct the defective pixels on the screen which are not performed as expected.

Steps

1. Hold  to go to the main menu.
 2. Go to  **Function Settings**, and select .
 3. Press  to enter the DPC setting interface.
 4. Press  or  select **Axis**, and press  to confirm. Press  or  to set the coordinates until the cursor reaches the defective pixel. If you select , the cursor moves left and right; if you select , the cursor moves up and down.
 5. Press  or  to select , and press  correct the defective pixel.
 6. Hold  to exit.
-

Note

- The selected defective pixel can be magnified and displayed on the right of the interface.



Figure 3-6 Correct Defective Pixel

- If the screen OSD blocks the defective pixel, move the cursor to reach the defective pixel, then the device performs mirror display automatically as shown in the figures below.

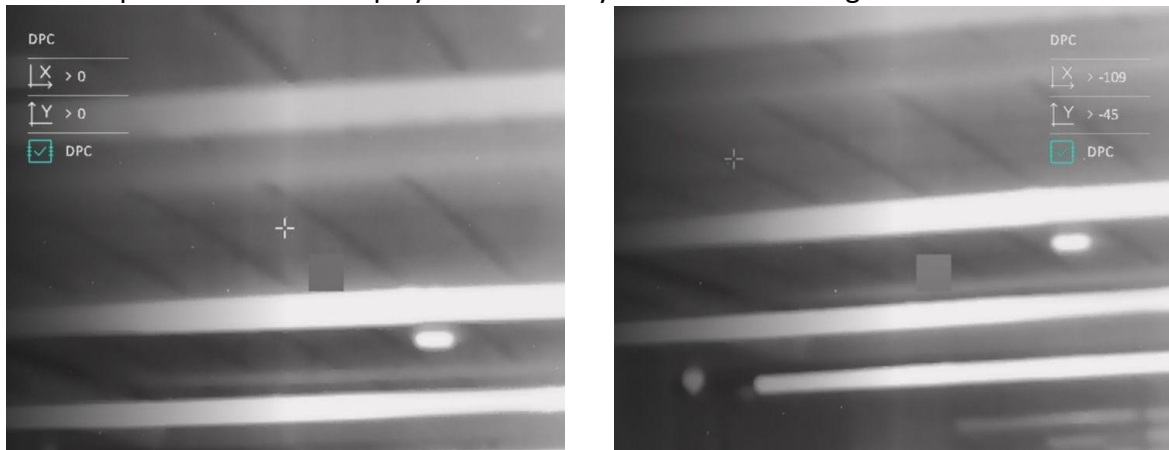

Figure 3-7 Mirror Effect







Chapter 4 Measure Distance

The device can detect the distance between the target and the observation position.

Before You Start

When measuring the distance, keep the hand and the position steady. Otherwise, the accuracy may be affected.

Steps

1. Hold **[M]** to show the main menu.
2. Select  and press **[M]** to go to the measurement interface.
 - 1) Press  to show the setting interface. Press  or  to select the target from **Deer**, **Grey Wolf**, **Brown Bear**, and **Custom**, and press **[M]** to confirm.
 - 2) Press  or  to set the target height.

Note

The available height ranges from 0.1 m to 9.0 m.

- 3) Hold **[M]** to save the setting and return to the measurement interface.
3. Align the center of top mark with the edge of target top. Press **[M]** to confirm. The cursor blinks on the top edge of the target.
4. Align the center of bottom mark with the edge of target bottom. Press **[M]** to confirm.

Result

The right top of the image displays the distance measurement result and the height of the target.



Figure 4-1 Measurement Result

Note









When PIP is enabled, PIP view remains in the distance measurement interface.

Chapter 5 General Settings

5.1 Set OSD

This function can display or hide the OSD information on the live view interface.

Steps

1. Hold  to show the main menu.
2. Go to  **Function Settings**, and select .
3. Press  to enter the setting interface. Press  or  to select the OSD information you want to display or hide.
4. Press  to enable or disable the selected OSD information.
5. Hold  to save and exit.









Note

Only when the OSD function is enabled, other OSD information can be displayed.

5.2 Set Display Brightness

You can adjust the display brightness of the screen in the quick menu.

Steps

1. In the live view mode, press  to show the quick menu.
2. Select , and press  to confirm.
3. Press  and  to adjust display brightness.
4. Hold  to save settings and exit.



Note





This function varies according to different camera models.

5.3 Burning Prevention

This function can prevent the detector of the thermal channel from being burned. When this function is enabled, the shield will close if the grey scale of the detector reaches a certain value.

Steps

1. Hold  to show the main menu.

2. Go to  **Function Settings**, and select .
 3. Press  to enable or disable the burn-prevention function.
 4. Hold  to save settings and exit.
-

 **Note**

Avoid direct sunlight and enable the burning prevention function to reduce the risk of sensor damage from the heat.

5.4 Capture and Video

5.4.1 Capture Picture

On the main live view page, press  to capture picture.

 **Note**

When capturing succeeds, the image freezes for 1 second and a prompt shows on the display. For exporting captured pictures, refer to **5.6 Export Files**.

5.4.2 Record Video

Steps



1. In the main live view, hold  and start recording.



Figure 5-1 Start Recording

The left top of image displays the information of recording time.

2. Hold  again to stop recording.
-

What to do next

For exporting recording files, refer to **5.6 Export Files**.

5.5 Hot Tracking

The device can detect the highest temperature spot in the scene and mark it on display.

Steps

1. Hold  to show the main menu.
2. Press  or  to select , and press  to mark the spot of highest temperature.

Result



When the function is enabled,  displays in the spot of highest temperature. When the scene changes, the  moves.



Figure 5-2 Hot Tracking

Note

This function varies according to different camera models.

5.6 Export Files

5.6.1 Export Files via T-Vision

You can access device albums and export files to your phone via T-Vision.

Before You Start

Install T-Vision on your mobile phone.

Steps

1. Open T-Vision, and connect your device to the app. See **2.4.1 Client Software Connection**.

2. Tap **Picture & Video** to access device albums.

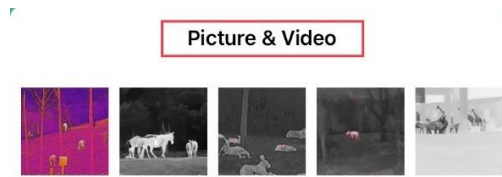



Figure 5-3 Access Device Albums

3. Tap to select a file, and tap  to export the file to your local phone albums.

Note

- Please refer to the user manual of the app for detailed operations.
- You can also access device albums by tapping bottom left icon in the live view interface.

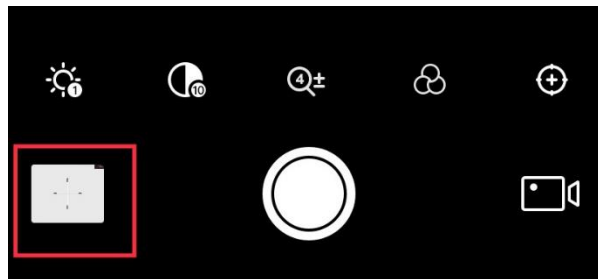

Figure 5-4 Access Device Albums

- The exporting operation may vary due to app updates. Please take the actual app version for reference.
-

5.6.2 Export Files via PC

This function is used to export recorded videos and captured pictures.

Before You Start

Turn off hot spot function.

Steps

1. Connect the device and PC with cable.

Note

Make sure the device is turned on when connecting the cable.

2. Open computer disk and select the disk of device. Go to the DCIM folder and find the folder named after the capture year and month. For example, if you capture a picture or record a video on June 2022, go to **DCIM** → **202206** to find the picture or video.

3. Select and copy the files to PC.
 4. Disconnect the device from your PC.
-









Note

- The device displays images when you connect it to PC. But functions such as recording, capturing and hot spot are disabled.
 - When you connect the device to PC for the first time, it installs the drive program automatically.
 - You can also export files via T-Vision APP. See the user manual of the app for detailed operation.
-

Chapter 6 System Settings









6.1 Date Adjustment

Steps

1. Hold  to show the main menu.
2. Go to  **General Settings**, and select .
3. Press  to enter the configuration interface.
4. Press  to select the year, month, or day to be synchronized, and press  or  to change the number, then press  again to finish the setting.
5. Hold  to save settings and exit.

6.2 Synchronize Time









Steps

1. Hold  to show the main menu.
2. Go to  **General Settings**, and select .
3. Press  to enter the configuration interface.
4. Press  to select the hour, minute, second to be synchronized, and press  or  to change the number, then press  again to finish the setting.
5. Hold  to save settings and exit.

6.3 Language Settings

You can select the device language in this function.

Steps

1. Hold  to show the main menu.
2. Go to  **General Settings**, and select .
3. Press  to enter the language configuration interface.
4. Press  or  to select the language as required, and press  to confirm.
5. Hold  to save settings and exit.

6.4 Unit Settings

You can switch the unit for distance measurement.

Steps

1. Hold  to show the main menu.
2. Go to  **General Settings**, and select .
3. Press  to enter the unit setting interface. Press  or  to select the unit as required.
4. Hold  to save settings and exit.





6.5 CVBS Output

The CVBS output is used to debug the device. You can also view the device image on the display unit for details.

Before You Start

Connect the device and the display unit via USB to CVBS cable. Make sure the device is turned off when connecting the cable.

Steps





1. Hold  to show the main menu of device.
2. Go to  **Function Settings**, and select .
3. Press  to turn on CVBS output.
4. Hold  to save settings and exit.

Note

The CVBS cable is not included in the package. Please purchase it by yourself.





6.6 View Device Information

Steps

1. Hold  to show the main menu of device.
2. Go to  **General Settings**, and select .
3. Press  to confirm. You can view the device information such as version and serial No.
4. Hold  to save settings and exit.

6.7 Restore Device

Steps

1. Hold  to show the menu of device.
2. Go to  **General Settings**, and select .
3. Press  to restore the device to defaults according to the prompt.

Chapter 7 Frequently Asked Questions

7.1 Why does the charge indicator flash improperly?

Check the following items.

1. Check whether the device is charged with standard power adapter and the charging temperature is above 0 °C (32 °F).
2. The device is equipped with built-in charging protection module. Charge the device in power off status.

7.2 Why is the power indicator off?

Check whether the device is off-battery. Check the indicator after charging the device for 5 minutes.

7.3 The image is not clear, how to adjust it?

Adjust the diopter adjustment knob until the image is clear. Refer to section *Adjust Diopter*.

7.4 Capturing or recording fails. What's the problem?

Check the following items.

- Whether the device is connected to your PC. Capturing or recording is disabled in this status.
- Whether the storage space is full.
- Whether the device is low-battery.

7.5 Why the PC cannot identify the device?

Check the following items.

- Whether the device is connected to your PC with supplied USB cable.
- If you use other USB cables, make sure the cable length is no longer than 1 m.

Safety Instruction



These instructions are intended to ensure that user can use the product correctly to avoid danger or property loss.

Laws and Regulations

- Use of the product must be in strict compliance with the local electrical safety regulations.

Symbol Conventions

The symbols that may be found in this document are defined as follows.

Symbol	Description
 Danger	Indicates a hazardous situation which, if not avoided, will or could result in death or serious injury.
 Caution	Indicates a potentially hazardous situation which, if not avoided, could result in equipment damage, data loss, performance degradation, or unexpected results.
 Note	Provides additional information to emphasize or supplement important points of the main text.

Transportation

- Keep the device in original or similar packaging while transporting it.
- Keep all wrappers after unpacking them for future use. In case of any failure occurred, you need to return the device to the factory with the original wrapper. Transportation without the original wrapper may result in damage on the device and the company shall not take any responsibilities.
- Do not drop the product or subject it to physical shock. Keep the device away from magnetic interference.

Power Supply

- Input voltage should meet the Limited Power Source (5 VDC, 2 A) according to the IEC62368-1 standard. Please refer to technical specifications for detailed information.
- Make sure the plug is properly connected to the power socket.
- DO NOT connect multiple devices to one power adapter, to avoid over-heating or fire hazards caused by overload.
- Use the power adapter provided by qualified manufacturer. Refer to the product specification for detailed power requirements.

Battery

- The built-in battery cannot be dismantled. Please contact the manufacture for repair if necessary.
- The built-in battery type is 18650, and the battery size should be 24 mm × 72 mm. The rated

voltage and capacity are 3.635 VDC/3350 mAh.

- For long-term storage of the battery, make sure it is fully charged every half year to ensure the battery quality. Otherwise, damage may occur.
- Use the battery provided by qualified manufacturer. Refer to the product specification for detailed battery requirements.
- CAUTION: Risk of explosion if the battery is replaced by an incorrect type.
- Improper replacement of the battery with an incorrect type may defeat a safeguard (for example, in the case of some lithium battery types).
- Do not dispose of the battery into fire or a hot oven, or mechanically crush or cut the battery, which may result in an explosion.
- Do not leave the battery in an extremely high temperature surrounding environment, which may result in an explosion or the leakage of flammable liquid or gas.
- Do not subject the battery to extremely low air pressure, which may result in an explosion or the leakage of flammable liquid or gas.
- Dispose of used batteries according to the instructions.
- Use the battery provided by qualified manufacturer. Refer to the product specification for detailed battery requirements.

Maintenance

- If the product does not work properly, please contact your dealer or the nearest service center. We shall not assume any responsibility for problems caused by unauthorized repair or maintenance.
- Wipe the device gently with a clean cloth and a small quantity of ethanol, if necessary.
- If the equipment is used in a manner not specified by the manufacturer, the protection provided by the device may be impaired.

Using Environment

- Make sure the running environment meets the requirement of the device. The operating temperature shall be -20 °C to 55 °C (-4 °F to 131 °F), and the operating humidity shall be 95% or less.
- DO NOT expose the device to high electromagnetic radiation or dusty environments.
- DO NOT aim the lens at the sun or any other bright light.

Emergency

- If smoke, odor, or noise arises from the device, immediately turn off the power, unplug the power cable, and contact the service center.

COMPLIANCE NOTICE: The thermal series products might be subject to export controls in various countries or regions, including without limitation, the United States, European Union, United Kingdom and/or other member countries of the Wassenaar Arrangement. Please consult your professional legal or compliance expert or local government authorities for any necessary export license requirements if you intend to transfer, export, re-export the thermal series products between different countries.

Legal Information

About this Manual

The Manual includes instructions for using and managing the Product. Pictures, charts, images and all other information hereinafter are for description and explanation only. The information contained in the Manual is subject to change, without notice, due to firmware updates or other reasons. Please find the latest version of this Manual at the company website Please use this Manual with the guidance and assistance of professionals trained in supporting the Product.

Trademarks Acknowledgement

Trademarks and logos mentioned are the properties of their respective owners.

LEGAL DISCLAIMER

TO THE MAXIMUM EXTENT PERMITTED BY APPLICABLE LAW, THIS MANUAL AND THE PRODUCT DESCRIBED, WITH ITS HARDWARE, SOFTWARE AND FIRMWARE, ARE PROVIDED "AS IS" AND "WITH ALL FAULTS AND ERRORS". OUR COMPANY MAKES NO WARRANTIES, EXPRESS OR IMPLIED, INCLUDING WITHOUT LIMITATION, MERCHANTABILITY, SATISFACTORY QUALITY, OR FITNESS FOR A PARTICULAR PURPOSE. THE USE OF THE PRODUCT BY YOU IS AT YOUR OWN RISK. IN NO EVENT WILL OUR COMPANY BE LIABLE TO YOU FOR ANY SPECIAL, CONSEQUENTIAL, INCIDENTAL, OR INDIRECT DAMAGES, INCLUDING, AMONG OTHERS, DAMAGES FOR LOSS OF BUSINESS PROFITS, BUSINESS INTERRUPTION, OR LOSS OF DATA, CORRUPTION OF SYSTEMS, OR LOSS OF DOCUMENTATION, WHETHER BASED ON BREACH OF CONTRACT, TORT (INCLUDING NEGLIGENCE), PRODUCT LIABILITY, OR OTHERWISE, IN CONNECTION WITH THE USE OF THE PRODUCT, EVEN IF OUR COMPANY HAS BEEN ADVISED OF THE POSSIBILITY OF SUCH DAMAGES OR LOSS.

YOU ACKNOWLEDGE THAT THE NATURE OF THE INTERNET PROVIDES FOR INHERENT SECURITY RISKS, AND OUR COMPANY SHALL NOT TAKE ANY RESPONSIBILITIES FOR ABNORMAL OPERATION, PRIVACY LEAKAGE OR OTHER DAMAGES RESULTING FROM CYBER-ATTACK, HACKER ATTACK, VIRUS INFECTION, OR OTHER INTERNET SECURITY RISKS; HOWEVER, OUR COMPANY WILL PROVIDE TIMELY TECHNICAL SUPPORT IF REQUIRED.

YOU AGREE TO USE THIS PRODUCT IN COMPLIANCE WITH ALL APPLICABLE LAWS, AND YOU ARE SOLELY RESPONSIBLE FOR ENSURING THAT YOUR USE CONFORMS TO THE APPLICABLE LAW. ESPECIALLY, YOU ARE RESPONSIBLE, FOR USING THIS PRODUCT IN A MANNER THAT DOES NOT INFRINGE ON THE RIGHTS OF THIRD PARTIES, INCLUDING WITHOUT LIMITATION, RIGHTS OF PUBLICITY, INTELLECTUAL PROPERTY RIGHTS, OR DATA PROTECTION AND OTHER PRIVACY RIGHTS. YOU SHALL NOT USE THIS PRODUCT FOR ILLEGAL HUNTING ANIMALS, INVASION OF PRIVACY OR ANY OTHER PURPOSE WHICH IS ILLEGAL OR DETRIMENTAL TO THE PUBLIC INTEREST. YOU SHALL NOT USE THIS PRODUCT FOR ANY PROHIBITED END-USES, INCLUDING THE DEVELOPMENT OR PRODUCTION OF WEAPONS OF MASS DESTRUCTION, THE DEVELOPMENT OR PRODUCTION OF CHEMICAL OR BIOLOGICAL WEAPONS, ANY ACTIVITIES IN THE CONTEXT RELATED TO ANY NUCLEAR EXPLOSIVE OR UNSAFE NUCLEAR FUEL-CYCLE, OR IN SUPPORT OF HUMAN RIGHTS ABUSES. IN THE EVENT OF ANY CONFLICTS BETWEEN THIS MANUAL AND THE APPLICABLE LAW, THE LATTER PREVAILS.

Regulatory Information

These clauses apply only to the products bearing the corresponding mark or information.

FCC INFORMATION

Please take attention that changes or modification not expressly approved by the party responsible for compliance could void the user's authority to operate the equipment.



This equipment complies with FCC/IC RSS-102 radiation exposure limits set forth for an uncontrolled environment.

FCC compliance: This product has been tested and found to comply with the limits for a Class B digital device, pursuant to Part 15 of the FCC Rules. These limits are designed to provide reasonable protection against harmful interference in a residential installation. This product generates, uses, and can radiate radio frequency energy and, if not installed and used in accordance with the instructions, may cause harmful interference to radio communications. However, there is no guarantee that interference will not occur in a particular installation. If this product does cause harmful interference to radio or television reception, which can be determined by turning the equipment off and on, the user is encouraged to try to correct the interference by one or more of the following measures:

- Reorient or relocate the receiving antenna.
- Increase the separation between the equipment and receiver.
- Connect the equipment into an outlet on a circuit different from that to which the receiver is connected.
- Consult the dealer or an experienced radio/TV technician for help.

FCC Conditions

This device complies with part 15 of the FCC Rules. Operation is subject to the following two conditions:

1. This device may not cause harmful interference.
2. This device must accept any interference received, including interference that may cause undesired operation.

EU/UK Compliance Statement



This product and - if applicable - the supplied accessories too are marked with "CE" and comply therefore with the applicable harmonized European standards listed under the Directive 2014/30/EU (EMCD), Directive 2014/35/EU (LVD), Directive 2011/65/EU (RoHS).



Directive 2012/19/EU (WEEE Directive): Products marked with this symbol cannot be disposed of as unsorted municipal waste in the European Union. For proper recycling, return this product to your local supplier upon the purchase of equivalent new equipment, or dispose of it at designated collection points. For more information see: www.recyclethis.info



According to the Waste Electrical and Electronic Equipment Regulations 2013: Products marked with this symbol cannot be disposed of as unsorted municipal waste in the United Kingdom. For proper recycling, return this product to your local supplier upon the purchase of equivalent new equipment, or dispose of it at designated collection points. For more information see: www.recyclethis.info.



Directive 2006/66/EC and its amendment 2013/56/EU (Battery Directive): This product contains a battery that cannot be disposed of as unsorted municipal waste in the European Union. See the product documentation for specific battery information. The battery is marked with this symbol, which may include lettering to indicate cadmium (Cd), lead (Pb), or mercury (Hg). For proper recycling, return the battery to your supplier or to a designated collection point. For more information see: www.recyclethis.info.

According to the Batteries and Accumulators (Placing on the Market) Regulations 2008 and the Waste Batteries and Accumulators Regulations 2009: This product contains a battery that cannot be disposed of as unsorted municipal waste in the United Kingdom. See the product documentation for specific battery information. The battery is marked with this symbol, which may include lettering to indicate cadmium (Cd), lead (Pb), or mercury (Hg). For proper recycling, return the battery to your supplier or to a designated collection point. For more information see: www.recyclethis.info.

