

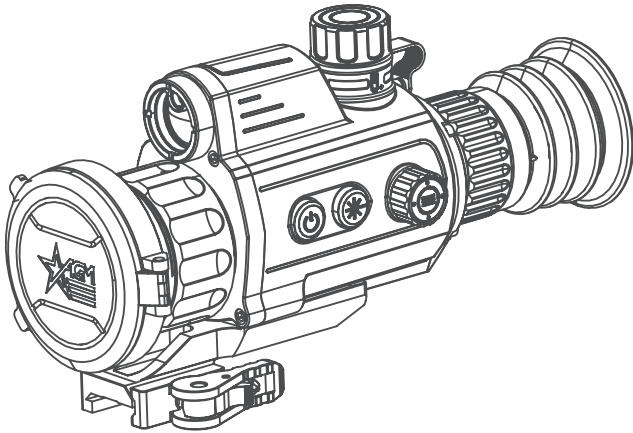

AGM  
GLOBAL  
VISION



# RATTLER LRF

THERMAL IMAGING RIFLESCOPE  
WITH LASER RANGEFINDER

USER MANUAL

© 2021 AGM Global Vision, LLC. All rights reserved.

This documentation is subject to change without notice.

No parts of this manual, in whole or in part, may be copied, photocopied, translated, or transmitted by any electronic medium or in machine-readable form without the prior written permission of AGM Global Vision, LLC.

If you have questions that are not covered in this manual, or need service, contact AGM Global Vision customer support for additional information prior to returning a product.

## **AGM Global Vision, LLC**

**173 West Main Street**

**PO Box 962**

**Springerville, AZ 85938**

**Tel. 928.333.4300**

**support@agmglobalvision.com**

**www.agmglobalvision.com**

## **EXPORT INFORMATION**

Buyer acknowledges that all products supplied by AGM Global Vision, LLC are subject to U.S. export control laws, including, but not limited to, the Export Administration Regulations, the International Economic Emergency Powers Act, and various U.S. embargoes and sanctions. AGM Global Vision products may not be exported, re-exported, or transferred contrary to U.S. export control laws. In particular, AGM Global Vision products may not be exported, re-exported, or transferred to prohibited countries, individuals, organizations, or entities, including but not limited to those individuals and entities listed on the List of Specially Designated Nationals and Blocked Persons administered or maintained by the U.S. Office of Foreign Assets Control ("OFAC"), the various lists maintained by the Bureau of Industry and Security of the Department of Commerce, and the U.S. State Department and Buyer represents and warrants that neither Buyer nor any of its officers, directors, or employees are on such lists. Distribution or resale by Buyer to such countries, individuals, organizations, or entities is expressly prohibited. Buyer has and will maintain a positive process to ensure compliance with this Section.

## FCC INFORMATION

Please take attention that changes or modification not expressly approved by the party responsible for compliance could void the user's authority to operate the equipment.



This equipment complies with FCC/IC RSS-102 radiation exposure limits set forth for an uncontrolled environment.

FCC compliance: This product has been tested and found to comply with the limits for a Class B digital device, pursuant to Part 15 of the FCC Rules. These limits are designed to provide reasonable protection against harmful interference in a residential installation. This product generates, uses, and can radiate radio frequency energy and, if not installed and used in accordance with the instructions, may cause harmful interference to radio communications. However, there is no guarantee that interference will not occur in a particular installation. If this product does cause harmful interference to radio or television reception, which can be determined by turning the equipment off and on, the user is encouraged to try to correct the interference by one or more of the following measures:

- Reorient or relocate the receiving antenna.
- Increase the separation between the equipment and receiver.
- Connect the equipment into an outlet on a circuit different from that to which the receiver is connected.
- Consult the dealer or an experienced radio/TV technician for help.

## FCC Conditions

This device complies with part 15 of the FCC Rules. Operation is subject to the following two conditions:

1. This device may not cause harmful interference.
2. This device must accept any interference received, including interference that may cause undesired operation.

## EU CONFORMITY STATEMENT



This product and - if applicable - the supplied accessories too are marked with "CE" and comply therefore with the applicable harmonized European standards listed under the EMC Directive 2014/30/EU, the RoHS Directive 2011/65/EU



2012/19/EU (WEEE directive): Products marked with this symbol cannot be disposed of as unsorted municipal waste in the European Union. For proper recycling, return this product to your local supplier upon the purchase of equivalent new equipment, or dispose of it at designated collection points. For more information see: [www.recyclethis.info](http://www.recyclethis.info)



2006/66/EC (battery directive): This product contains a battery that cannot be disposed of as unsorted municipal waste in the European Union. See the product documentation for specific battery information. The battery is marked with this symbol, which may include lettering to indicate cadmium (Cd), lead (Pb), or mercury (Hg). For proper recycling, return the battery to your supplier or to a designated collection point. For more information see: [www.recyclethis.info](http://www.recyclethis.info)

## INDUSTRY CANADA ICES-003 COMPLIANCE

This device meets the CAN ICES-3 (B)/NMB-3(B) standards requirements.

# LIST OF CONTENTS

TITLE	PAGE
Safety Summary	5
<b>1. GENERAL INFORMATION</b>	<b>7</b>
1.1 System Description	7
1.2 Standard Components	8
1.3 Optional Equipment	9
1.4 Key Features	9
<b>2. OPERATING INSTRUCTIONS</b>	<b>10</b>
2.1. Basic Operations	10
2.2 Main Function	15
2.3 Client Software Introduction	24
<b>3. MAINTENANCE</b>	<b>25</b>
3.1 Maintenance	25
3.2 Troubleshooting	26
<b>4. WARRANTY INFORMATION</b>	<b>27</b>
4.1 Warranty Information and Registration	27
<b>5. SPECIFICATIONS</b>	<b>29</b>
5.1 Specifications	29

## SAFETY SUMMARY

- Read and follow all instructions
- Read all warnings
- Only use the attachments/accessories specified by the manufacturer
- All service must be provided by the manufacturer

### WARNING:

This product contains natural rubber latex, which may cause potentially fatal allergic reactions! If you are allergic to latex, it is important that you strictly avoid exposure to products that contain it.

### WARNINGS AND CAUTIONS:

#### **Transportation**

- Keep the device in original or similar packaging while transporting it.
- Keep all wrappers after unpacking them for future use. In case of any failure occurred, you need to return the device to the factory with the original wrapper. Transportation without the original wrapper may result in damage on the device and the company shall not take any responsibilities.
- DO NOT drop the product or subject it to physical shock. Keep the device away from magnetic interference.

#### **Power Supply**

- Make sure the plug is properly connected to the power socket.
- DO NOT connect multiple devices to one power adapter, to avoid overheating or fire hazards caused by overload.
- The battery charger is included in the package. The input voltage for the supplied battery charger should meet the Limited Power Source (5 VDC, 2 A).
- The power source should meet limited power source or PS2 requirements according to IEC 60950-1 OR ICE 62368-1 standard.

#### **Battery**

- Improper use or replacement of the battery may result in explosion hazard. Replace with the same or equivalent type only. The battery type is 18650 with the protection board, and the battery size should be 19 mm × 70 mm. The rated voltage and capacity are 3.6 VDC/3.35 Ah (12.06 Wh). Dispose of used batteries in conformance with the instructions provided by the battery manufacturer.
- Make sure the battery temperature is between 0°C to 45°C (32°F to 113°F) when charging.
- For long-term storage of the battery, make sure it is fully charged every half year to ensure the battery quality. Otherwise, damage may occur.
- Do not charge other battery types with the supplied charger. Confirm there is no flammable material within 2 m of the charger during charging.
- DO NOT place the battery near heating or fire source. Avoid direct sunlight.
- DO NOT swallow the battery to avoid chemical burns.
- DO NOT place the battery in the reach of children.

- The battery can not be charged with external power source directly.
- The device can not be charged, please use the supplied charger to charge the battery.
- Please purchase the adapter by yourself. The using environment of the adapter should be consistent with that of the device.

### **Maintenance**

- If the product does not work properly, please contact your dealer or the nearest service center. We shall not assume any responsibility for problems caused by unauthorized repair or maintenance.
- Wipe the device gently with a clean cloth and a small quantity of ethanol, if necessary.
- If the equipment is used in a manner not specified by the manufacturer, the protection provided by the device may be impaired.
- Clean the lens with soft and dry cloth or wiping paper to avoid scratching it.

### **Using Environment**

- Make sure the running environment meets the requirement of the device. The operating temperature shall be -20°C to 55°C (-4°F to 131°F), and the operating humidity shall be 95% or less.
- DO NOT expose the device to extremely hot, cold, dusty, corrosive, saline-alkali, or damp environments.
- This device can only be safely used in the region below 2000 meters above the sea level.
- Avoid equipment installation on vibratory surface or places subject to shock (neglect may cause equipment damage).
- DO NOT aim the lens at the sun or any other bright light.

### **NOTES:**

- The detector spectral band provides better visibility through smoke, dust, rain, smog, etc.
- Infrared radiation does not travel through glass. As a result, the scope does not detect objects if they are behind glass windows or other barriers.

### **EMERGENCY:**

If smoke, odor, or noise arises from the device, immediately turn off the power, unplug the power cable, and contact the service center.

### **LASER EMERGENCY:**



When any laser equipment is in use, make sure that the device lens is not exposed to the laser beam, or it may burn out. The laser radiation emitted from the device can cause eye injuries, burning of skin or inflammable substances. Before enabling the light supplement function, make sure no human or inflammable substances are in front of the laser lens. Do not place the device where minors can fetch it.

# 1 GENERAL INFORMATION

## 1.1 SYSTEM DESCRIPTION

The AGM Rattler LRF is a compact thermal imaging scope developed for 24-hour operation under any weather and environmental conditions. Available in multiple configurations: 384x288 or 640x512 thermal detector, and 35mm or 50mm objective lens. These options allow the customer to choose the perfect unit for their needs. The 35mm lens is designed for medium-range applications, while the 50mm lens will be better suited for long-range engagements.

Equipped with a highly sensitive, 12 $\mu$ m thermal detector and 1024x768 OLED monitor, the AGM Rattler LRF provides a clear image under harsh environment conditions including darkness, fog, smoke, dust, rain, snow, brush, camouflage, etc. The device can be used as a thermal riflescope or handheld monocular, and can be applied to scenarios such as patrolling, hunting, static observation, and more.

The built-in laser range finder of the AGM Rattler LRF is designed to determine the exact distance between the observer and the target. Measurement results are displayed on the scopes monitor. One 18650 rechargeable battery gives the device up to 4.5 hours of continuous operation time. An external 5V power bank (battery pack) can be easily connected via a USB to USB-C connector for a significant increase of operating time. The device is equipped with fast EMMC storage for on-board video recording and image capturing. An internal Wi-Fi module for live video streaming and video/image recording via application are also included.

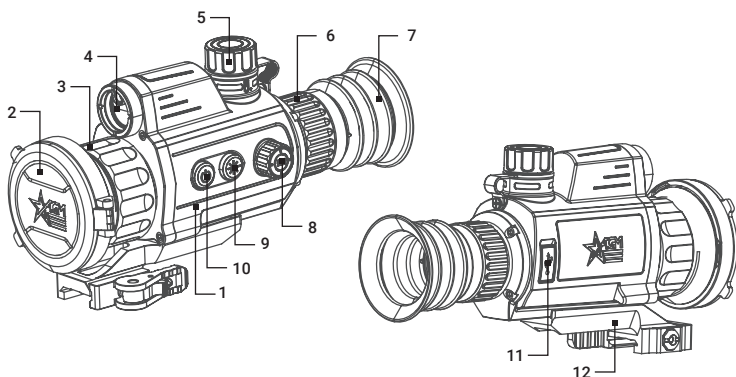

FIGURE 1-1. MAIN PARTS

TABLE 1-1. MAIN PARTS

ITEM	DESCRIPTION	ITEM	DESCRIPTION
1	Body	7	Eye cup
2	Lens Cap	8	Operation Wheel
3	Focus Ring	9	Measure Button
4	Laser Range Finder	10	Power Button
5	Battery Compartment	11	USB Type-C Interface
6	Eye piece Focus Ring	12	Mount

### 1.3 STANDARD COMPONENTS

The standard components are shown in Figure 1-2 and listed in Table 1-2. The ITEM column indicates the number used to identify items in Figure 1-2.

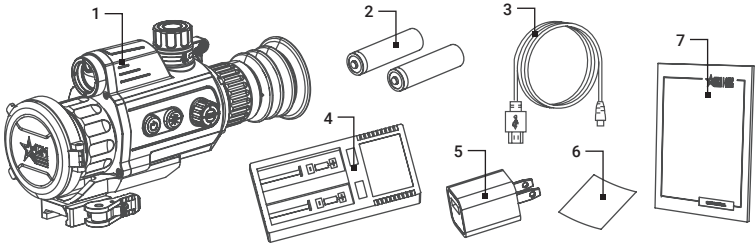

FIGURE 1-2. STANDARD COMPONENTS

TABLE 1-2. STANDARD COMPONENTS

ITEM	DESCRIPTION	QUANTITY
1	Riflescope	1
2	18650 Rechargeable Battery	2
3	USB Cable	1
4	Battery Charger	1
5	Power Adapter	1
6	Lens Cloth	1
7	User Manual	1



## 1.4 OPTIONAL EQUIPMENT

Optional items are shown in Figure 1-3 and listed in Table 1-3.

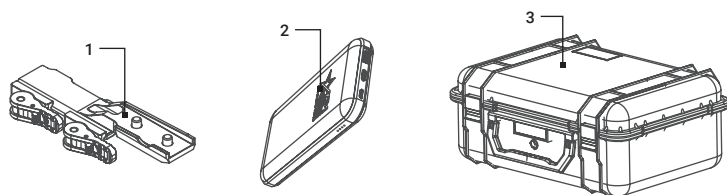

FIGURE 1-3. OPTIONAL EQUIPMENT

TABLE 1-3. OPTIONAL EQUIPMENT

ITEM	DESCRIPTION	PART NO.
1	AGM-2111 Long QR Mount for Rattler	6306LMR1
2	AGM Power Bank	6308EPB1
3	Hard Case for Storage/Transportation	6610HCS1

## 1.2 KEY FEATURES

- 12 $\mu$ m high sensitivity thermal detector
- Fast 50 Hz imaging
- Built-in laser rangefinder
- 1x, 2x, 4x, 8x digital zoom
- High resolution OLED display
- Adjustable color palettes
- Various reticle types and colors
- One shot zero correction
- Highest temperature tracking
- On-board video recording and snapshot
- Built-in EMMC storage (16 GB)
- Wi-Fi data transmission
- Standby mode
- Up to 4.5 hours continuous runtime
- External power supply compatibility
- Waterproof & shockproof
- Limited 3-year warranty

# 2 OPERATING INSTRUCTIONS

## 2.1. BASIC OPERATIONS

### 2.1.1 UNPACKING

The following steps must be completed prior to each mission.

1. Open the carrying case, remove the device, and verify that all components are included.
2. Inspect the device for any obvious evidence of damage to the optical surfaces, body, eyecup, operation buttons, etc. Ensure that all optical surfaces are clean and ready for use. Clean all optical surfaces with a lens tissue.

### 2.1.2 BATTERY INSTALLATION

1. Turn the battery cover (A) anticlockwise to loosen it.
2. Make sure the battery is fully charged. Insert the battery (B) into the battery compartment (C) with the positive mark inward.
3. Turn the battery cover clockwise to tighten it.

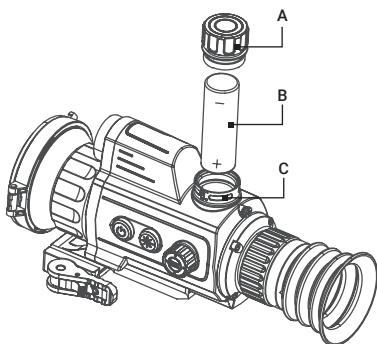

FIGURE 2-1. BATTERY INSTALLATION

#### NOTE:

Remove the battery from the battery compartment if the device is not used for a long time.

### 2.1.3 CONNECTING THE DEVICE

1. Open the USB interface cover.

2. Connect the device and power adapter with a Type-C cable to power on the device. Alternatively, connect the device and PC to copy/delete files.

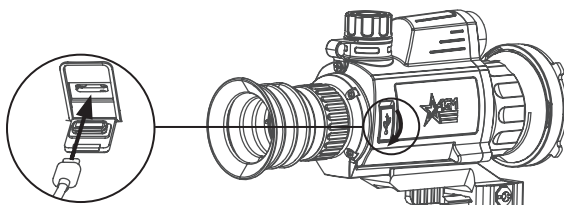

FIGURE 2-2. CABLE INTERFACE

## 2.1.4 CONTROL BUTTONS

The Rattler LRF controls are shown in Figures 2-3 and are defined in Tables 2-1. Each button is responsible for some functions selected by short press or long press (hold) the button. Pushing a button for 2+ second is considered “long press” (hold).

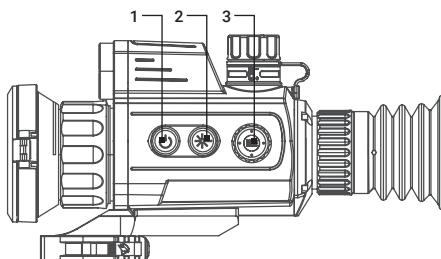





FIGURE 2-3. RATTLER LRF CONTROLS

TABLE 2-1. RATTLER LRF CONTROL FUNCTIONS

ITEM	CONTROLS	FUNCTIONS
1	POWER BUTTON	Press: Standby mode / Wake up device. Hold: Power ON/OFF.
2	MEASURE BUTTON	Press: Capture image. Hold: Measure the distance with laser.
3	OPERATION WHEEL	Press: Switch palettes. Hold: Menu operation. Rotate: Switch digital zoom.
2 + 3	MEASURE BUTTON + WHEEL BUTTON	Press: Start/Stop video recording. Hold: Manual FFC.

### NOTE:

Press the MEASURE button  and operation wheel button  at the same time to start or stop recording.

Hold the MEASURE button  and operation wheel button  at the same time to correct the nonuniformity of display manually (manual FFC).

## 2.1.5 POWER ON AND OFF

### Power On

When the battery is enough, hold the POWER button  to power on the device. Refer to the figure below for the main view of the display.

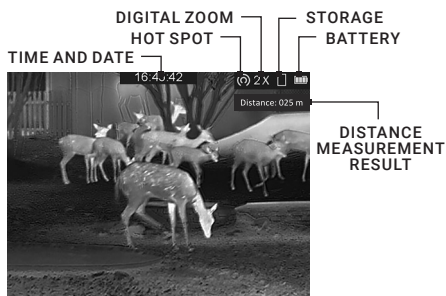



FIGURE 2-4. THE DISPLAY MAIN VIEW

### Power Off



When the device is turned on, hold the POWER BUTTON  to power off the device.

### NOTE

See the battery icon on the device display for the electricity quantity. Icon  means the battery is fully charged, and icon  means that the battery is low. When the low power note shows, charge the battery.

In the “Auto Power Off” menu you can set the time for the automatic shutdown of the device as required (OFF / 30 min. / 45 min.).

## 2.1.6 STANDBY MODE

Standby mode is used to save battery power. In the view mode, press the  button. After a few seconds, the display will turn off. Press the  button again to exit the Standby mode.

## 2.1.7 THERMAL VIEW OBSERVATION

1. Power on the device.
2. Hold the device and make sure the eyepiece covers your eye.
3. Adjust the diopter adjustment ring until the OSD text or image is clear.
4. Point the device towards the target of the view. Bring the object into focus by rotate the objective focus ring.

### NOTE:

You must perform the focus adjustment before any further use of the riflescope.

5. Set palette, brightness, contrast, scene mode and FFC (Flat Field Correction), to display the best image effect.

## 2.1.8 PALETTE SETTINGS

You can select different palettes to display the same scene in different effects. Press operation wheel button  in live view interface to switch palettes.

TABLE 2-2. PALETTE SETTINGS

PALETTE	DESCRIPTION
OPTICAL	The image of optical channel is displayed in this mode.
WHITE HOT	The hot part is white-colored in view. The higher the temperature is, the lighter the color is.
BLACK HOT	The hot part is black-colored in view. The higher the temperature is, the more black the color is.
RED HOT	The hot part is red-colored in view. The higher the temperature is, the redder the color is.
FUSION	From high temperature to low temperature, the image is colored in from white, yellow, red, pink to purple.

## 2.1.9 DIGITAL ZOOM

In the live view interface, rotate the operation wheel to switch the digital zoom of the device between 1x, 2x, 4x and 8x. The image magnification value is displayed on the screen:

- Rattler LRF TS35-384: 3x, 6x, 12x, 24x
- Rattler LRF TS50-384: 4.5x, 9x, 18x, 36x
- Rattler LRF TS35-640: 2x, 4x, 8x, 16x
- Rattler LRF TS50-640: 2.5x, 5x, 10x, 20x

## 2.1.10 VIDEO RECORDING / IMAGE CAPTURE

### Video Recording

In the live view interface, press MEASURE button  and operation wheel button  at the same time to start recording.

The left top of image displays the information of recording time.

Press  and  buttons at the same time again to stop recording.



FIGURE 2-5. VIDEO RECORDING

## Snapshot Capturing

In the main live view interface, press  button to capture picture.

### NOTE:

- When capturing succeeds, the image freezes for 1 second and a prompt shows on the display.
- For exporting captured pictures, refer to Files Export.

## 2.1.11 FILE EXPORT

1. Connect the thermal riflescope to your PC with USB cable and open the detected disk.
2. Open computer disk and select the disk of device. Go to the DCIM folder and find the folder named after the capture year and month. For example, if you capture a picture or record a video on June 2021, go to DCIM -> 202106 to find the picture or video.
  - Select and copy the videos to PC and play the file with the player.
  - Select and copy the snapshots to PC and view the files.
3. Disconnect the device from your PC.

### NOTE:

- The device displays images when you connect it to PC. But functions such as recording, capturing and hot spot are disabled.
- When you connect the device to PC for the first time, it installs the drive program automatically.

## 2.1.12 INSTALLING THE RATTLER ON A PICATINNY/WEAVER RAIL

### WARNING:

Always make sure your firearm is unloaded before you place the scope on the firearm. Reconfirm that the chamber is empty if you stop the procedure then resume later. Safe firearms handling rules should be followed at all times.

The Rattler LRF comes fully-assembled with a Picatinny/Weaver mount. The mount is attached to the scope with two screws.

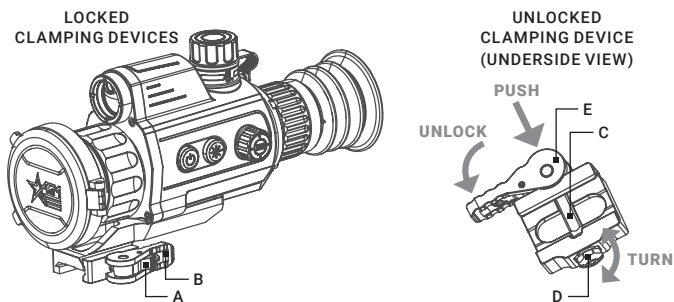

FIGURE 2-6. MOUNT

To install the Rattler LRF on a Picatinny/Weaver rail, perform the following (Figure 2-6):

1. Unlock the clamping device of the scope mount by pushing down on the lever holder (A) and unlocking the lever (B).
2. Install the scope on the Picatinny/ Weaver rail so that the stop (C) slides into the transverse slot on the rail.
3. Affix the scope to the rail by locking the lever (B).
4. Verify that the clamping device is firmly holding the Rattler LRF. If necessary, adjust the clamping device's lever-cam lock as detailed in part 2.1.13 (Clamping Device Adjustment).

### 2.1.13 CLAMPING DEVICE ADJUSTMENT

To adjust the mount's clamping device, do the following:

1. Remove the Rattler LRF from the weapon.
2. With the clamping device unlocked (as shown in Figure 2-6), push the cam (E) towards the arrow, which will cause the nut (D) to slide out of its hole.
3. To tighten/ loosen the clamping device, push down on the cam (E) and turn the nut (D) CW/ CCW respectively, in one-two increments (see note below). Much like when the cam (E) is released, backward-moving spring will cause the nut (D) to slide back into its hole.

#### NOTE:

The eight-sided nut of the mount lever-cam lock will only fit into their hole if turned in one of the discrete positions, using increments equal to  $360^{\circ}/8$ .

4. Verify that the adjusted lever-cam lock securely holds the weapon mounting rail.

## 2.2 MAIN FUNCTIONS

### 2.2.1 MENU OPERATION

When the device is turned on, hold the  button to display the menu.

Rotate the operation wheel to move between menu items. The active element is highlighted in orange. Press the  button to select menu item or change an option. Hold  button to exit the menu.

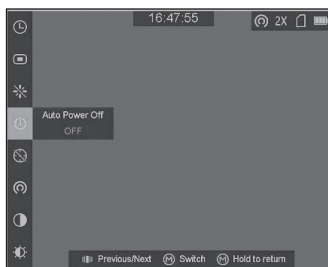









FIGURE 2-7. THE MAIN MENU



TABLE 2-3. MENU FUNCTION

MENU ITEM	SYMBOL	OPTION	FUNCTION
CONTRAST		5 Levels of contrast	Adjust the image contrast.
BRIGHTNESS		5 Levels of brightness	Adjust the image brightness.
SCENE MODE		Recognition	Switch between the Recognition mode and Jungle mode.
		Jungle	
TRIGGER CALIBRATION		---	Performs the correction as preset FFC mode.
FFC		Auto / Manual / External	Select the Flat Field Correction (FFC) mode.
CVBS		OFF	Turn on and off the CVBS Output function to view the video on CVBS monitor.
		ON	
PIP		UP-Left / Center / UP- Right / Off	Enable or disable the PIP function. Set the position of the PIP window.
DPC		---	Correct dead pixel manually.
BURNING PREVENTION		ON	Turn on and off the Burn Prevention function.
		OFF	
RETICLE		5 Types of reticle	Select the reticle type. Set the center of the reticle.
COLOR		OFF / White / Red / Green / Black	Select the reticle color.
TRAJECTORY		5 Profiles	One shot zero correction.
LANGUAGE		17 Languages	Select the language of interface.
VERSION		---	View the firmware version number and serial number.
RESTORE		---	Restore the device to defaults.
TIME SYNC.		Time Format / Time / Date	Set the time and date.





MENU ITEM	SYMBOL	OPTION	FUNCTION
OSD		ON	Enable or disable OSD.
		OFF	
MEASURE		---	Enter distance measurement mode.
AUTO POWER OFF		OFF/30 min/ 45 min	Set the automatic shutdown time.
HOT TRACKING		OFF	Enable/disable hot spot mark (marking the spot of highest temperature).
		ON	
NETWORK		OFF	Enable or disable the Wi-Fi hotspot.
		Hotspot	

## 2.2.2 CONTRAST ADJUSTMENT

1. Hold  button to go to the menu.
2. Rotate the wheel to select  Contrast menu item and press  button to adjust the image contrast.

You can select one of five levels of the contrast.





## 2.2.3 BRIGHTNESS ADJUSTMENT

1. Hold  button to go to the menu.
2. Rotate the wheel to select  Brightness menu item and press  button to adjust the brightness.

You can select one of five levels of the brightness to adjust the image lighter or darker.

## 2.2.4 SCENE MODE

You can select proper Scene Mode according to environment temperature to improve the display effect.

1. Hold  button to go to the menu.
2. Rotate the wheel to select  /  Scene Mode menu item (  is default option) and press  to switch scene.





**Recognition mode** (  ) improves an image so that the object edge is more distinct.

**Jungle mode** (  ) is more suitable for hunting environment because of the highlight function of small objects.

3. Hold  to save settings and exit.



## 2.2.5 TRIGGER CALIBRATION

Trigger Calibration performs the correction of nonuniformity of display in the mode preset in the FFC menu.

1. Hold  button to show the menu.
2. Rotate the wheel to select  menu item and press  to trigger the calibration.
3. Hold  button to exit.

## 2.2.6 FFC (FLAT FIELD CORRECTION)

Flat Field Correction (FFC) function can correct nonuniformity of display.

1. Hold  button to show the menu.
2. Rotate the wheel to select  menu item and press  to switch the FFC mode between Manual, Auto and External.

**Manual:** Enter Trigger Calibration in the menu and press  button to correct the nonuniformity of display (refer to section 2.2.5).

**Auto:** The riflescope performs FFC automatically when switching on or rebooting the camera.

**External:** Cover the lens cap, then enter Trigger Calibration in the menu and press  button to correct the nonuniformity of display (section 2.2.5).

3. Hold  button to exit.

## 2.2.7 CVBS OUTPUT

You can view the video on CVBS monitor, to get a better and clear image, more convenient to check the detail.



1. Connect the USB-CVBS cable to USB port of thermal riflescope and to monitor's CVBS port.

### **NOTE:**



USB-CVBS cable need to be purchase separately.

### **NOTE:**

CVBS Output function doesn't support hot plug, so please connect the cable before power on.

2. Hold  button to show the menu.
3. Select **CVBS** menu item and press  button to turn on or turn off the CVBS video output.

## 2.2.8 PICTURE IN PICTURE MODE

1. Hold  button to show the menu.
2. Select  PIP menu item and enter Picture In Picture (PIP) mode. The details show in the upper part of screen.

### **NOTE:**

When Reticle is enabled, the PIP view is the detail of crosshair.

When Reticle is not enabled, the PIP view is the detail of central part.

3. Press the wheel  to switch the PIP type. Up-Left, Center, Up-Right, and Close are selectable.

4. Hold  button to exit.



If digital zoom is enabled, the PIP view also zooms. If the digital zoom ratio exceeds 4, the PIP does not zoom.

### 2.2.9 DEFECTIVE PIXELS CORRECTION

Defective Pixels Correction (DPC) function can correct the defective pixels on the screen which are not performed as expected.

Before you start switch the palettes mode to White Hot mode.

1. Hold  button to show the menu.

2. Rotate the wheel to select  DPC menu item, and press  to enter the DPC setting interface.

3. Press  button to switch the moving direction of the cursor. Rotate the wheel to move the cursor until it reaches the defective pixel.

4. Press  to correct the defective pixel.



#### NOTE:

The selected defective pixel can be magnified and displayed at the bottom right of the interface.

### 2.2.10 BURNING PREVENTION

This function can prevent damage to the thermal sensor from the sun or other high temperature bright light source. When enabling this function, the shield will close until the environment turns to normal.

1. Hold  button to go to the menu.

2. Rotate the wheel to select  menu item and press  button to enable or disable the Burn Prevention function.

#### NOTE:

When the burn-prevention function is disabled, the shield won't be forced to close in such conditions.

### 2.2.11 RETICLE AND BORESIGHTING

Enable the reticle to aim at the target.

1. Hold  button to show the menu.

2. Select  Reticle menu item. A reticle shows in the center of the view.



FIGURE 2-8. RETICLE PATTERNS

3. Press the wheel to select the Freeze function (Optional).

**NOTE:**

When enabling the Freeze function in reticle, you can adjust the position of the cursor on a frozen image. This function can prevent image flutter.

4. Rotate the wheel to select the reticle type. Then press the wheel button  to confirm.

**NOTE:**

The scale intervals of the Reticle 4 changes synchronously under the current digital zoom. The value of one scale interval of the Reticle 4 is 2 mil (6.75 MOA).

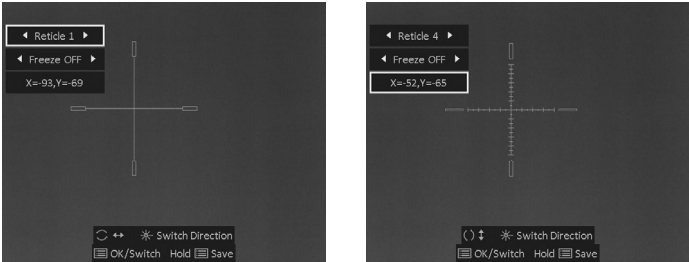

**FIGURE 2-9. RETICLE AND BORESIGHTING**

You can boresight the scope by moving the reticle on screen:

1. Press the wheel to select the coordinates. The coordinate shows the current position of the reticle.
2. Rotate the wheel to move the cursor, and press  to switch the moving direction.
3. Hold the wheel to save and exit.





**TABLE 2-5. BORESIGHT CORRECTIONS**

MODEL	ADJUSTMENT VALUE	RETICLE OFFSET	BORESIGHT INCREMENT
RATTLER LRF TS35-384	1 click	1 pixel	0.13 mil / 0.44 MOA / 1.3 cm at 100 m distance / 0.46 in at 100 yd distance
RATTLER LRF TS50-384	1 click	1 pixel	0.09 mil / 0.31 MOA / 0.9 cm at 100 m distance / 0.32 in at 100 yd distance
RATTLER LRF TS35-640	1 click	1 pixel	0.22 mil / 0.73 MOA / 2.2 cm at 100 m distance / 0.76 in at 100 yd distance
RATTLER LRF TS50-640	1 click	1 pixel	0.15 mil / 0.51 MOA / 1.5 cm at 100 m distance / 0.53 in at 100 yd distance

## 2.2.12 RETICLE COLOR

You can change the color of the reticle.



Enable reticle first.

1. Hold  button to show the menu.
2. Select  Color menu item and press  button to switch the color of reticle. White, Green, Red, and Black colors are selectable.
3. Hold  button to save and exit.

## 2.2.13 TRAJECTORY CORRECTION

Enable the trajectory correction to shot the target with high accuracy by marking the offset between the big crosshair and small crosshair.

Trajectory correction available only with Reticle 1 type. Select Reticle 1 in the Reticle menu.

1. In the live view mode, hold the wheel  to show the menu.
2. Select  Trajectory menu item. Two crosshairs show in the view. The big one is reticle crosshair, and the small one is trajectory correction crosshair.

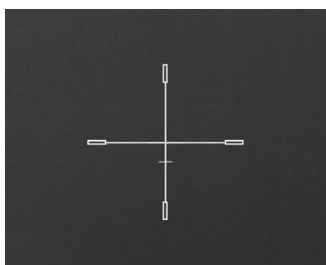
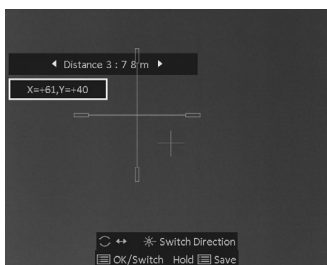













FIGURE 2-10. TRAJECTORY CORRECTION



3. Set the distance.
    - 1) Press the wheel button  to select the distance, and then rotate the wheel to adjust the distance between the target and the device.
    - 2) Press  to switch the selected distance value.
    - 3) Press the wheel  to save the distance settings.
  4. Set the crosshair position of trajectory correction.
    - 1) Aim the big crosshair at the target.
    - 2) Shot and mark the actual drop point of the bullet.
    - 3) Rotate the wheel  to move the small cursor to the position of the actual drop point. Press  to switch the moving direction of the small cursor. You can view the coordinate of the cursor in the view.
  5. Press the wheel button  to save the coordinates of the current position.
  6. Rotate the wheel to switch to the next distance.
  7. Repeat step 3 to 5 to set another trajectory correction position.
- You can save up to five corrections for different distances. Corrective aiming points will be displayed with short lines on the reticle.
8. Hold  button to exit.

## 2.2.14 LANGUAGE SETTING

You can select different languages of user interface.



1. Hold  button to show the menu.
2. Rotate the wheel to select  Language menu item and press  button to select the language.
3. Rotate the wheel to select the language as required, and press  to confirm.

## 2.2.15 VIEW DEVICE INFORMATION







1. Hold  button to show the menu of device.
2. Select  Version menu item and press  button. You can view the device information such as firmware version, and serial number.

## 2.2.16 RESTORE DEVICE





You can reset the settings of device.

1. Hold  button to show the menu of device.
2. Select  Restore menu item and press  button to restore the device to defaults according to the prompt.

## 2.2.17 TIME SYNCHRONIZATION

1. Hold  button to show the menu.
2. Rotate the wheel to select  menu and press  button to enter the Time Sync.
3. Press  to switch the time system, and rotate the wheel to select the time and date to be synchronized.
4. Press  and rotate the wheel to set the time and date, and press  again to finish the setting.
5. Hold  to save settings and exit.

## 2.2.18 OSD

1. Hold  button to go to the menu.
2. Rotate the wheel to select  /  menu item and press  button to switch the OSD mode.

When OSD (On-Screen Display) is on the information such as time, date, Wi-Fi hotspot activation, digital zoom, storage memory status, and battery status displays in top right corner of viewfinder.





## 2.2.19 DISTANCE MEASUREMENT

The device can detect the distance between the target and the observation position with laser.

### NOTE:

When measuring the distance, keep the hand and the position steady. Otherwise, the accuracy may be affected.



1. Hold the wheel  to show the menu.

2. Rotate the wheel to select  menu item and press  button to enable Laser Ranging.
3. Hold  to return to the live view interface.
4. Aim the cursor at the target and hold the  button to measure the target distance.

The distance measurement result is displayed at the upper right of the image.

## 2.2.20 AUTO POWER OFF



You can set the time for the automatic shutdown of the device as required.

1. Hold  button to show the menu of device.
2. Rotate the wheel to select  Auto Power Off menu item and press  button to select OFF, 30 min or 45 min.

## 2.2.21 HOT TRACKING



The device can detect the highest temperature spot in the scene and mark it on display.

1. Hold  button to show the menu.
2. Select  /  and press  button to enable/disable hot spot mark (marking the spot of highest temperature).

When the hot spot mark is enabled, the  mark displays in the spot of the highest temperature. When the scene changes, the  mark moves.

## 2.2.22 NETWORK CONFIGURATION

Connect your phone to the Wi-Fi hotspot of the riflescope, you can configure the parameters and realize functions of the device.

1. Hold  button to show the menu.
2. Select  menu item to enable Wi-Fi hotspot function.
3. Turn on the WLAN and connect to the Wi-Fi hotspot.
  - Hotspot Name: Wlan-IPTS Serial No.
  - Hotspot Password: Last 9 digits of Serial No.
4. Search the client software on App Store (iOS System) or Google Play™ (Android System) to download and install the app. T-Vision APP is recommend.
5. Open the APP and connect your phone with the device. You can view the interface of riflescope on your phone.

### **NOTE:**



When the power is less than 15%, the Wi-Fi hotspot function will be turned off automatically.

## 2.3 CLIENT SOFTWARE INTRODUCTION

We recommend using T-Vision software. Install the client software on your mobile phone first, and then connect your phone to the hotspot of the riflescope. Refer to section 2.2.22 for details of hotspot connection.

### **NOTE:**

The device password is set by user at first activation. If the password was lost or forgotten, it can be reset. To make a reset, provide the following action:

1. Hold  button to show the menu of device.
2. Move the cursor to  menu item and press the button  to restore all parameters to default settings.

1. Run the app and connect the phone or tablet with the device.
2. If the device is inactivated, set the password and activate it. If the device is activated, enter the password to add it to the app.
3. When the device is added, the live view can be seen. You can view the interface of the riflescope on the software. User can change such image parameters as brightness, contrast, zoom, palettes directly via phone or tablet as well as record video on phone/tablet memory.

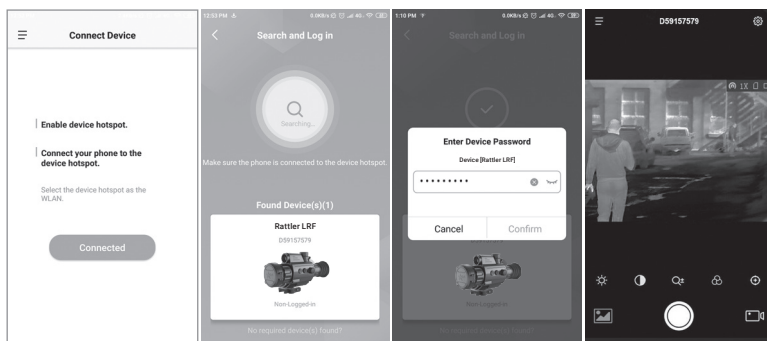

FIGURE 2-11. CLIENT SOFTWARE



# 3 MAINTENANCE

## 3.1 MAINTENANCE

### 3.1.1 CLEANING PROCEDURES

1. Gently brush off any dirt from the body of the device using a clean, soft cloth.
2. Moisten the cloth with fresh water and gently wipe down the external surfaces (except lenses).
3. Dry any wet surfaces (except lenses) using another dry, clean, soft cloth.
4. Using a lens brush, carefully remove all loose dirt from the lenses.
5. Dampen a cotton swab with ethanol and slowly, gently wipe down the lenses. Clean the glass surfaces using circular movements, starting from the center of the lens and moving out towards the edge, without touching the lens holder. Change the cotton swab after each circular stroke. Repeat this step until the glass surfaces are clean.
6. Clean the accessories with a soft brush (or cloth) dampened with soap and water.

### 3.1.2 LASER MAINTENANCE

It is not necessary to maintain the laser regularly. If the laser does not work, the laser assembly needs to be replaced in the factory under warranty.

**CAUTION:**

Use of controls or adjustments or performance of procedures other than those specified herein may result in hazardous radiation exposure.

### 3.1.3 PREPARING FOR EXTENDED STORAGE

**CAUTION:**

Thoroughly dry each item before placing them into the storage case.

To prepare the riflescope for extended storage:

1. Clean the riflescope and accessories.
2. Place all items into the storage case.

### 3.1.4 UPDATING THE DEVICE FIRMWARE

1. Download the firmware update package to your PC and unzip it.
2. Connect the thermal device to your PC with USB cable.
3. Turn on the thermal device.
4. Open the detected disk (USB drive) in file manager program. Copy the unzipped .dav file and paste it to the root directory of the device.

5. Turn off the device.

6. Turn on the device. After a while, the firmware update process will start automatically. During the update, the screen will display the inscription "Upgrading ...". The update process will be completed when the inscription "Upgrading ..." goes out.

Repeat steps 4-6 for each updating file.

7. Turn off the device and disconnect it from your PC.

## 3.2 TROUBLESHOOTING

Table 3-1 lists the most common malfunctions that may occur with your equipment. Perform the tests, inspections, and corrective actions in the order they appear in the table.

This table does not list all the malfunctions that may occur with your device, or all of the tests, inspections, and corrective actions that may be necessary to fix them. If the equipment malfunction is not corrected by the suggested actions, or a problem occurs that is not listed in this table, please contact AGM Global Vision's Customer Support center or your retailer.

TABLE 3-1. TROUBLESHOOTING

MALFUNCTION	CORRECTIVE ACTION
The riflescope fails to activate.	<ol style="list-style-type: none"><li>1. Batteries are missing or improperly installed. Insert batteries or install correctly.</li><li>2. Batteries are dead. Replace the batteries.</li><li>3. Batteries, surfaces or contacts are dirty or corroded. Clean the contact.</li></ol>
Device power indicator is off.	Examine whether the device is off-battery.
The image of the riflescope is not clear.	Perform the riflescope adjustment referring to section 2.1.
Wi-Fi is not found.	Examine whether the Wi-Fi function is turned on. If not, go to OSD menu and turn on Wi-Fi.
Capturing or recording fails.	Examine the items below: <ol style="list-style-type: none"><li>1. Whether the device is connected to your PC and disabled the capturing and recording.</li><li>2. Whether the storage space is full.</li><li>3. Whether the device is low-battery.</li></ol>
The PC cannot identify the riflescope.	Examine the items below: <ol style="list-style-type: none"><li>1. Whether the device is connected to your PC with standard USB cable.</li><li>2. If you use other USB cables, make sure the cable length is no longer than 1 m.</li></ol>

## 4 WARRANTY INFORMATION

### 4.1 WARRANTY INFORMATION AND REGISTRATION

#### 4.1.1 WARRANTY INFORMATION

This product is guaranteed to be free from manufacturing defects in material and workmanship under normal use for a period of three (3) years from the date of purchase. In the event that a defect covered by the warranty below occurs during the applicable period stated above, AGM Global Vision, at its discretion, will either repair or replace the product; such action on the part of AGM Global Vision shall be the full extent of AGM Global Vision's liability, and the Customer's sole and exclusive reparation. This warranty does not cover a product if it has been (a) used in ways other than its normal and customary manner; (b) subjected to misuse; (c) subjected to alterations, modifications or repairs by the Customer or by any party other than AGM Global Vision without prior written consent of AGM Global Vision; (d) is the result of a special order or categorized as "close-out" merchandise or merchandise sold "as-is" by either AGM Global Vision or the AGM Global Vision dealer; or (e) merchandise that has been discontinued by the manufacturer and either parts or replacement units are not available due to reasons beyond the control of AGM Global Vision. AGM Global Vision shall not be responsible for any defects or damage that in AGM Global Vision's view are a result from the mishandling, abuse, misuse, improper storage or improper operation of the device, including use in conjunction with equipment that is electrically or mechanically incompatible with, or of inferior quality to, the product, as well as failure to maintain the environmental conditions specified by the manufacturer. This warranty is extended only to the original purchaser. Any breach of this warranty shall be enforced unless the customer notifies AGM Global Vision at the address noted below within the applicable warranty period.

The customer understands and agrees that except for the foregoing warranty, no other warranties written or oral, statutory, expressed or implied, including any implied warranty of merchantability or fitness for a particular purpose, shall apply to the product. All such implied warranties are hereby and expressly disclaimed.

#### 4.1.2 LIMITATION OF LIABILITY

AGM Global Vision will not be liable for any claims, actions, suits, proceedings, costs, expenses, damages, or liabilities arising out of the use of this product. Operation and use of the product are the sole responsibility of the Customer. AGM Global Vision's sole undertaking is limited to providing the products and services outlined herein in accordance with the terms and conditions of this Agreement. The provision of products sold and services performed by AGM Global Vision to the Customer shall not be interpreted, construed, or regarded, either expressly or implied, as being for the benefit of or creating any obligation toward any third party of legal entity outside AGM Global Vision and the Customer; AGM Global Vision's obligations under this Agreement extend

solely to the Customer. AGM Global Vision's liability hereunder for damages, regardless of the form or action, shall not exceed the fees or other charges paid to AGM Global Vision by the customer or customer's dealer. AGM Global Vision shall not, in any event, be liable for special, indirect, incidental, or consequential damages, including, but not limited to, lost income, lost revenue, or lost profit, whether such damages were foreseeable or not at the time of purchase, and whether or not such damages arise out of a breach of warranty, a breach of agreement, negligence, strict liability, or any other theory of liability.

#### **4.1.3 PRODUCT REGISTRATION**

In order to validate the warranty on your product, the customer must complete and submit AGM Global Vision PRODUCT REGISTRATION FORM on our website ([www.agmglobalvision.com/customer-support](http://www.agmglobalvision.com/customer-support)).

#### **4.1.4 OBTAINING WARRANTY SERVICE**

To obtain warranty service on your unit, the End-user (Customer) must notify the AGM Global Vision service department via e-mail. Send any requests to [support@agmglobalvision.com](mailto:support@agmglobalvision.com) to receive a Return Merchandise Authorization number (RMA). When returning any device, please take the product to your retailer, or send the product, postage paid and with a copy of your sales receipt, to AGM Global Vision's service center at the address listed above. All merchandise must be fully insured with the correct postage; AGM Global Vision will not be responsible for improper postage or merchandise that becomes lost or damaged during shipment. When sending product back, please clearly write the RMA# on the outside of the shipping box. Please include a letter that indicates your RMA#, the Customer's Name, a Return Address, reason for the return, contact information (valid telephone numbers and/or an e-mail address), and proof of purchase that will help us to establish the valid start date of the warranty. Product merchandise returns that do not have an RMA# listed may be refused, or a significant delay in processing may occur. Estimated Warranty service time is 10-20 business days. The End-user/Customer is responsible for postage to AGM Global Vision for warranty service. AGM Global Vision will cover return postage/shipping after warranty repair to the End-user/Customer only if the product is covered by the aforementioned warranty. AGM Global Vision will return the product after warranty service by domestic UPS Ground service and/or domestic mail. Should any other requested, required, or international shipping methods be necessary, the postage/shipping fee will be the responsibility of the End-user/Customer.

For service, repair or replacement, please contact:

**AGM Global Vision, LLC**

**173 West Main Street**

**PO Box 962**

**Springerville, AZ 85938**

**Tel. 928.333.4300**

**[support@agmglobalvision.com](mailto:support@agmglobalvision.com)**

**[www.agmglobalvision.com](http://www.agmglobalvision.com)**

# 5 SPECIFICATIONS

## 5.1 SPECIFICATIONS

	RATTLER LRF TS35-384	RATTLER LRF TS50-384	RATTLER LRF TS35-640	RATTLER LRF TS50-640
Detector Type	12 $\mu$ m VOx Uncooled Focal Plane Arrays	12 $\mu$ m VOx Uncooled Focal Plane Arrays	12 $\mu$ m VOx Uncooled Focal Plane Arrays	12 $\mu$ m VOx Uncooled Focal Plane Arrays
Resolution	384×288	384×288	640×512	640×512
Refresh Rate	50 Hz	50 Hz	50 Hz	50 Hz
Response Waveband	8 $\mu$ m to 14 $\mu$ m	8 $\mu$ m to 14 $\mu$ m	8 $\mu$ m to 14 $\mu$ m	8 $\mu$ m to 14 $\mu$ m
Lens (Focal Length)	35 mm	50 mm	35 mm	50 mm
Aperture	F1.0	F1.0	F1.0	F1.0
Field of View (HxV)	7.53°×5.65°	5.28°×3.96°	12.52°×10.03°	8.78°×7.03°
Magnification	3x – 24x	4.5x – 36x	2x – 16x	2.5x – 20x
Digital Zoom	1x, 2x, 4x, 8x	1x, 2x, 4x, 8x	1x, 2x, 4x, 8x	1x, 2x, 4x, 8x
Observation Distance	1,750 m	2,500 m	1,750 m	2,500 m
Eye Relief	45 mm	45 mm	45 mm	45 mm
Monitor	1024×768, 0.39 inch, OLED, 50 Hz	1024×768, 0.39 inch, OLED, 50 Hz	1024×768, 0.39 inch, OLED, 50 Hz	1024×768, 0.39 inch, OLED, 50 Hz
FFC (Flat Field Correction)	Auto, Manual, External Correction	Auto, Manual, External Correction	Auto, Manual, External Correction	Auto, Manual, External Correction
Palettes	Black Hot, White Hot, Red Hot, Fusion	Black Hot, White Hot, Red Hot, Fusion	Black Hot, White Hot, Red Hot, Fusion	Black Hot, White Hot, Red Hot, Fusion

	RATTLER LRF TS35-384	RATTLER LRF TS50-384	RATTLER LRF TS35-640	RATTLER LRF TS50-640
<b>Highest Temperature Spot Tracking</b>	Yes	Yes	Yes	Yes
<b>Scene Mode</b>	Jungle, Recognition	Jungle, Recognition	Jungle, Recognition	Jungle, Recognition
<b>Reticle</b>	5 types, 4 colors, on/off	5 types, 4 colors, on/off	5 types, 4 colors, on/off	5 types, 4 colors, on/off
<b>Laser Range Finder</b>	Up to 600 m ±2 m accuracy	Up to 600 m ±2 m accuracy	Up to 600 m ±2 m accuracy	Up to 600 m ±2 m accuracy
<b>Laser Wavelength</b>	905 nm	905 nm	905 nm	905 nm
<b>Laser Safety Class</b>	Class 1	Class 1	Class 1	Class 1
<b>Boresight Adjustment</b>	Digital Controlled	Digital Controlled	Digital Controlled	Digital Controlled
<b>Boresight Increment</b>	0.13 mil / 0.44 MOA	0.09 mil / 0.31 MOA	0.22 mil / 0.73 MOA	0.15 mil / 0.51 MOA
<b>One Scale Interval (Reticle #4)</b>	2 mil / 6.75 MOA	2 mil / 6.75 MOA	2 mil / 6.75 MOA	2 mil / 6.75 MOA
<b>Hotspot</b>	Yes	Yes	Yes	Yes
<b>Sleep Mode</b>	Yes	Yes	Yes	Yes
<b>Picture In Picture Mode</b>	Yes	Yes	Yes	Yes
<b>Burn Prevention</b>	Yes	Yes	Yes	Yes
<b>Built-in Storage</b>	16 GB EMMC	16 GB EMMC	16 GB EMMC	16 GB EMMC
<b>Record Video</b>	On-board video recording	On-board video recording	On-board video recording	On-board video recording
<b>Capture Snapshot</b>	Yes	Yes	Yes	Yes
<b>CVBS Output</b>	Yes (via USB)	Yes (via USB)	Yes (via USB)	Yes (via USB)

	RATTLER LRF TS35-384	RATTLER LRF TS50-384	RATTLER LRF TS35-640	RATTLER LRF TS50-640
<b>Battery Type</b>	One 18650 (3.7V) Lithium Rechargeable Batteries	One 18650 (3.7V) Lithium Rechargeable Batteries	One 18650 (3.7V) Lithium Rechargeable Batteries	One 18650 (3.7V) Lithium Rechargeable Batteries
<b>Battery Operating Time (WiFi off)</b>	Up to 4.5 hours	Up to 4.5 hours	Up to 4.5 hours	Up to 4.5 hours
<b>Battery Capacity Display</b>	Yes	Yes	Yes	Yes
<b>External Power</b>	5 VDC/2 A, USB Type-C	5 VDC/2 A, USB Type-C	5 VDC/2 A, USB Type-C	5 VDC/2 A, USB Type-C
<b>Working Temperature</b>	-20°C to 55°C (-4°F to 131°F)	-20°C to 55°C (-4°F to 131°F)	-20°C to 55°C (-4°F to 131°F)	-20°C to 55°C (-4°F to 131°F)
<b>Protection Level</b>	IP67	IP67	IP67	IP67
<b>Drop Test Height</b>	1.5 m (4.9 ft)	1.5 m (4.9 ft)	1.5 m (4.9 ft)	1.5 m (4.9 ft)
<b>Dimensions (LxWxH)</b>	200×66×109 mm (7.8×2.6×4.3 in)	210×74×109 mm (8.3×2.9×4.3 in)	200×66×109 mm (7.8×2.6×4.3 in)	210×74×109 mm (8.3×2.9×4.3 in)
<b>Weight (w/o batteries)</b>	652 g (1.44 lb)	722 g (1.59 lb)	652 g (1.44 lb)	722 g (1.59 lb)

*\*All data subject to change without notice.*



### **AGM Global Vision, LLC**

#### MAIN OFFICE

173 West Main Street

PO Box 962

Springerville, AZ 85938

USA

Tel. +1.928.333.4300

[info@agmglobalvision.com](mailto:info@agmglobalvision.com)

[www.agmglobalvision.com](http://www.agmglobalvision.com)

#### EUROPEAN OFFICE

#6 Andrey Lyapchev Blvd

Sofia, P.C. 1756

Bulgaria

Tel. +35.988.412.5573

[info@agmglobalvision.eu](mailto:info@agmglobalvision.eu)

[www.agmglobalvision.eu](http://www.agmglobalvision.eu)