

# ObservIR

THERMAL AND DIGITAL BINOCULAR  
WITH BUILT-IN LASER RANGEFINDER

© 2024 AGM Global Vision, LLC. All rights reserved.

This documentation is subject to change without notice.

No parts of this manual, in whole or in part, may be copied, photocopied, translated, or transmitted by any electronic medium or in machine-readable form without the prior written permission of AGM Global Vision, LLC.

If you have questions that are not covered in this manual, or need service, contact AGM Global Vision customer support for additional information prior to returning a product.

## **AGM Global Vision, LLC**

**173 West Main Street**

**PO Box 962**

**Springerville, AZ 85938**

**Tel. 928.333.4300**

**support@agmglobalvision.com**

**www.agmglobalvision.com**

## **EXPORT INFORMATION**

Buyer acknowledges that all products supplied by AGM Global Vision, LLC are subject to U.S. export control laws, including, but not limited to, the Export Administration Regulations, the International Traffic in Arms Regulations, the International Economic Emergency Powers Act, and various U.S. embargoes and sanctions. AGM Global Vision products may not be exported, re-exported, or transferred contrary to U.S. export control laws. In particular, AGM Global Vision products may not be exported, re-exported, or transferred to prohibited countries, individuals, organizations, or entities, including but not limited to those individuals and entities listed on the List of Specially Designated Nationals and Blocked Persons administered or maintained by the U.S. Office of Foreign Assets Control ("OFAC"), the various lists maintained by the Bureau of Industry and Security of the Department of Commerce, and the U.S. State Department and Buyer represents and warrants that neither Buyer nor any of its officers, directors, or employees are on such lists. Distribution or resale by Buyer to such countries, individuals, organizations, or entities is expressly prohibited. Buyer has and will maintain a positive process to ensure compliance with this Section.

## FCC INFORMATION

Please note that changes or modification not expressly approved by the party responsible for compliance could void the user's authority to operate the equipment.

This equipment complies with FCC/IC RSS-102 radiation exposure limits set forth for an uncontrolled environment.



FCC compliance: This product has been tested and found to comply with the limits for a Class B digital device, pursuant to Part 15 of the FCC Rules. These limits are designed to provide reasonable protection against harmful interference in a residential installation.

This product generates, uses, and can radiate radio frequency energy and, if not installed and used in accordance with the instructions, may cause harmful interference to radio communications. However, there is no guarantee that interference will not occur in a particular installation. If this product does cause harmful interference to radio or television reception, which can be determined by turning the equipment off and on, the user is encouraged to try to correct the interference by one or more of the following measures:

- Reorient or relocate the receiving antenna.
- Increase the separation between the equipment and receiver.
- Connect the equipment into an outlet on a circuit different from that to which the receiver is connected.
- Consult the dealer or an experienced radio/TV technician for help.

### FCC Conditions

This device complies with part 15 of the FCC Rules. Operation is subject to the following two conditions:

1. This device may not cause harmful interference.
2. This device must accept any interference received, including interference that may cause undesired operation.

## EU CONFORMITY STATEMENT



This product and - if applicable - the supplied accessories too are marked with "CE" and comply therefore with the applicable harmonized European standards listed under the EMC Directive 2014/30/EU, the RoHS Directive 2011/65/EU



2012/19/EU (WEEE directive): Products marked with this symbol cannot be disposed of as unsorted municipal waste in the European Union. For proper recycling, return this product to your local supplier upon the purchase of equivalent new equipment, or dispose of it at designated collection points. For more information see: [www.recyclethis.info](http://www.recyclethis.info)



2006/66/EC (battery directive): This product contains a battery that cannot be disposed of as unsorted municipal waste in the European Union. See the product documentation for specific battery information. The battery is marked with this symbol, which may include lettering to indicate cadmium (Cd), lead (Pb), or mercury (Hg). For proper recycling, return the battery to your supplier or to a designated collection point. For more information see: [www.recyclethis.info](http://www.recyclethis.info)

## INDUSTRY CANADA ICES-003 COMPLIANCE

This device meets the CAN ICES-3 (B)/NMB-3(B) standards requirements.

# LIST OF CONTENTS

TITLE	PAGE
Safety Summary	5
<b>1. GENERAL INFORMATION</b>	<b>7</b>
1.1 System Description	7
1.2 Standard Components	8
1.3 Optional Equipment	9
1.4 Key Features	9
<b>2. OPERATING INSTRUCTIONS</b>	<b>10</b>
2.1. Basic Operations	10
2.2 Main Function	18
2.3 Client Software Introduction	32
<b>3. MAINTENANCE</b>	<b>33</b>
3.1 Maintenance	33
3.2 Troubleshooting	34
<b>4. WARRANTY INFORMATION</b>	<b>35</b>
4.1 Warranty Information and Registration	35
<b>5. SPECIFICATIONS</b>	<b>37</b>
5.1 Specifications	37

## SAFETY SUMMARY

- Read and follow all instructions
- Read all warnings
- Only use the attachments/accessories specified by the manufacturer
- All service must be provided by the manufacturer

### **WARNING:**

This product contains natural rubber latex, which may cause potentially fatal allergic reactions! If you are allergic to latex, it is important that you strictly avoid exposure to products that contain it.

### **WARNING AND CAUTIONS:**

#### **Transportation**

- Keep the device in original or similar packaging while transporting it.
- Keep all wrappers after unpacking them for future use. In case of any failure occurred, you need to return the device to the factory with the original wrapper. Transportation without the original wrapper may result in damage on the device and the company shall not take any responsibilities.
- DO NOT drop the product or subject it to physical shock. Keep the device away from magnetic interference.

#### **Power Supply**

- The battery charger is included in the package. The input voltage for the supplied battery charger should meet the Limited Power Source (5 VDC, 2 A).
- The power source should meet limited power source or PS2 requirements according to IEC 60950-1 OR ICE 62368-1 standard.
- Make sure the plug is properly connected to the power socket.
- DO NOT connect multiple devices to one power adapter, to avoid overheating or fire hazards caused by overload.

#### **Battery**

- Improper use or replacement of the battery may result in explosion hazard. Replace with the same or equivalent type only.
- The battery type is 18650 with the protection board, and the battery size should be 19 mm × 70 mm. The rated voltage is 3.6 VDC, and the battery capacity is 3200 mA. Dispose of used batteries in conformance with the instructions provided by the battery manufacturer.
- Make sure the battery temperature is between 0 °C to 45 °C (32 °F to 113 °F) when charging.
- For long-term storage of the battery, make sure it is fully charged every half year to ensure the battery quality. Otherwise, damage may occur.
- Do not charge other battery types with the supplied charger. Confirm there is no flammable material within 2 m of the charger during charging.
- DO NOT place the battery near heating or fire source. Avoid direct sunlight.
- DO NOT swallow the battery to avoid chemical burns.
- DO NOT leave the battery in places accessible for children.
- The battery cannot be charged with external power source directly.
- The device cannot be charged, please use the supplied charger to charge the replaceable battery.

## Maintenance

- If the product does not work properly, please contact your dealer or the nearest service center. We shall not assume any responsibility for problems caused by unauthorized repair or maintenance.
- Wipe the device gently with a clean cloth and a small quantity of ethanol, if necessary.
- If the equipment is used in a manner not specified by the manufacturer, the protection provided by the device may be impaired.
- Clean the lens with soft and dry cloth or wiping paper to avoid scratching it.

## Using Environment

- Make sure the running environment meets the requirement of the device. The operating temperature shall be  $-30^{\circ}\text{C}$  to  $55^{\circ}\text{C}$  ( $-22^{\circ}\text{F}$  to  $131^{\circ}\text{F}$ ), and the operating humidity shall be 95% or less.
- DO NOT expose the device to extremely hot, cold, dusty, corrosive, saline-alkali, or damp environments.
- Avoid equipment installation on vibratory surface or places subject to shock (neglect may cause equipment damage).
- DO NOT aim the lens at the sun or any other bright light.

## EMERGENCY:

If smoke, odor, or noise arises from the device, immediately turn off the power, unplug the cable, and contact the service center.

## LASER CAUTION:



When any laser equipment is in use, make sure that the device lens is not exposed to the laser beam, or it may burn out. The laser radiation emitted from the device can cause eye injuries, burning of skin or inflammable substances. Before enabling the laser ranging function, make sure no human or inflammable substances are in front of the laser lens. Do not place the device where minors can fetch it. The wavelength is 905 nm, the pulse duration is 22 ns, and the max. power output is less than 1.6 mW. According to IEC 60825-1:2014, EN 60825-1:2014+A11:2021, and EN 50689:2021, this laser product is classified as Class 1 consumer laser product.



**IEC 60825-1: 2014**  
**EN 60825-1: 2014 + A11: 2021**

Complies with FDA performance standards for laser products except for conformance with IEC 60825-1 Ed. 3., as described in Laser Notice No. 56, dated May 8, 2019.

# 1 GENERAL INFORMATION

## 1.1 SYSTEM DESCRIPTION

The AGM ObserviR LRF Thermal & Digital Day/Night Vision binocular is some of the most technologically advanced and feature-packed optics in the world. The primary engine behind these binocular lies within the main thermal viewing channel, with its high-sensitivity 12 micron detector. Unlike other thermal binoculars on the market, the ObserviR LRF also come outfitted with a digital day/night channel as well, which is great for aiding in recognition of targets detected by the thermal channel. The built-in 1,000m laser rangefinder simply takes the ObserviR LRF to another level, and this is without even mentioning its 64GB of internal memory and Wi-Fi compatibility.

The ObserviR LRF binoculars also come packed with numerous software improvements, and many features that have become commonplace within the AGM thermal product assortment: high-sensitivity thermal detector, 25mm or 35mm Germanium lens with a 1.0 aperture, 3840x2160 ultra-low light CMOS sensor, various viewing modes, multiple color palettes, up to 8X digital zoom, picture-in-picture mode, built-in laser rangefinder, GPS module, long-range IR illuminator, up to 8 hours of battery life on removable, rechargeable 18650 batteries, USB Type-C port for external power capabilities, IP67 waterproof rating. The package includes four 18650 batteries, wrist strap and charger.

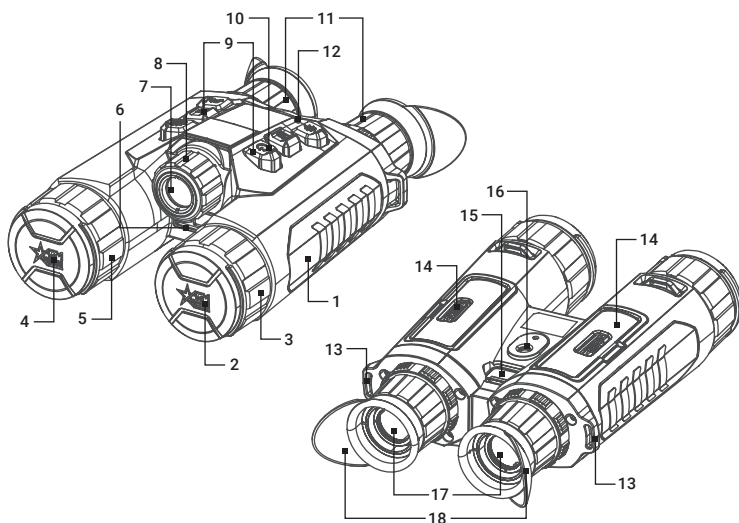

FIGURE 1-1. MAIN PARTS

**TABLE 1-1. MAIN PARTS**

ITEM	DESCRIPTION	ITEM	DESCRIPTION
1	Body	10	Power LED Indicator
2	Digital Lens with Cover	11	Diopter Adjustment Ring
3	Digital Lens Focus Ring	12	Microfone
4	Thermal Lens & Lens Cap	13	Neck Strap Attachment
5	Thermal Lens with Cover	14	Battery Compartment
6	Laser Rangefinder (LRF)	15	USB Type-C Interface
7	Infrared (IR) Illuminator	16	Tripod Adapter Socket
8	IR Focus Knob	17	Eyepiece
9	Control Buttons	18	Foldable Eyecup

## 1.2 STANDARD COMPONENTS

The standard components are shown in Figure 1-2 and listed in Table 1-2. The ITEM column indicates the number used to identify items in Figure 1-2.

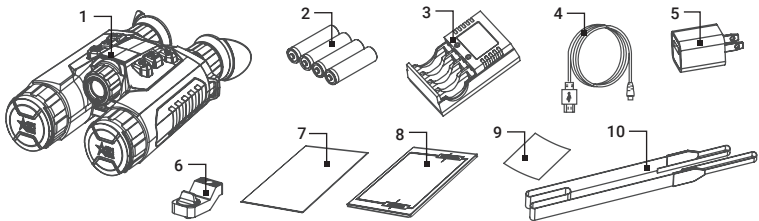

**FIGURE 1-2. STANDARD COMPONENTS**

**TABLE 1-2. STANDARD COMPONENTS**

ITEM	DESCRIPTION	QUANTITY
1	Binocular	1
2	18650 Rechargeable Battery	4
3	Battery Charger	1
4	USB Cable	1
5	Power Adapter	1
6	Tripod Adapter	1
7	Quick Start Guide	1
8	User Manual	1
9	Lens Cloth	1
10	Neck Strap	1



## 1.3 OPTIONAL EQUIPMENT

Optional items are shown in Figure 1-3 and listed in Table 1-3.

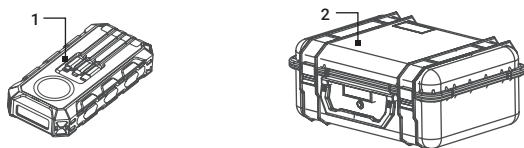

FIGURE 1-3. OPTIONAL EQUIPMENT

TABLE 1-3. OPTIONAL EQUIPMENT

ITEM	DESCRIPTION	PART NO.
1	AGM Power Bank 30,000 mAh	6628XPB31
2	Hard Case for Storage/Transportation	6610HCS1

## 1.4 KEY FEATURES

- Dual-spectrum thermal and digital day/night system
- 12 micron high-sensitivity thermal detector
- Up to 8x digital zoom
- Digital image processing technology
- Ultra-low illumination optical channel
- 3840×2160 optical resolution
- Built-in IR illuminator
- Eye-safe 1,000 m laser rangefinder
- 1920×1080 resolution, 0.49-inch OLED display
- Digital magnetic compass
- Built-in GPS module
- Video/audio recording and snapshot capture
- Built-in 64 GB EMMC storage
- Wi-Fi hotspot
- Standby mode
- 8-hour continuous operation on a single charge
- Auto screen-off function to saving energy
- External power supply capability
- Rugged rubberized housing
- Tripod mount adapter
- Waterproof and dustproof

# 2 OPERATING INSTRUCTIONS

## 2.1. BASIC OPERATIONS

### 2.1.1 UNPACKING

The following steps must be completed prior to each mission.

1. Open the carrying case, remove the device, and verify that all components are included.
2. Inspect the device for any obvious evidence of damage to the optical surfaces, body, eyecups, operation buttons, etc. Ensure that all optical surfaces are clean and ready for use. Clean all optical surfaces with a lens tissue.

### 2.1.2 BATTERY INSTALLATION

#### NOTE:

- Charge the batteries with the supplied battery charger for more than 4 hours before first use. You can also charge the battery installed in the device using an external 5V/2A power adapter via the binocular's Type-C port.
  - The device can operate with one battery installed, but some functions may not work fully. To ensure full performance, be sure to use two batteries for power.
  - Take the batteries away if you do not use the device for a long time.
1. Unlock the latch of the battery compartment.
  2. Open the battery compartment cover.

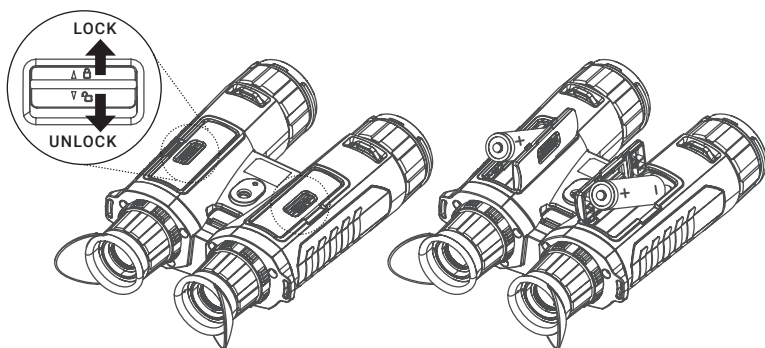

FIGURE 2-1. BATTERY INSTALLATION

3. Insert the 18650 battery into the battery compartment as the positive and negative marks indicate.
4. Close the battery compartment cover and lock it.
5. Repeat steps 1-4 to install the second battery.

### 2.1.3 CONTROL BUTTONS

The ObservIR LRF controls are shown in Figure 2-2 and are defined in Table 2-1. Each button is responsible for some functions selected by short press or long press the button. Pushing a button for 2+ second is considered “long press” (hold the button).

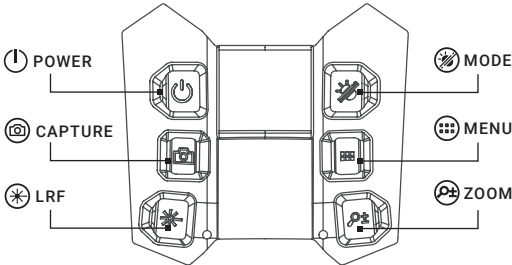



FIGURE 2-2. OBSERVIR CONTROL BUTTONS

TABLE 2-1. FUNCTIONS OF CONTROL BUTTONS



CONTROLS	FUNCTIONS
POWER	Press: Standby Mode / Wake Up Device Hold: Power ON/OFF
CAPTURE	Press: Image Capture Hold: Start/Stop Video Recording
LRF	Press: Turning On the Laser / Distance Measurement Double Press: Turning Off the Laser Hold: Image Calibration (FFC)
MODE	Press: Switch Palettes Hold: Switch DAY/NIGHT/AUTO Mode <u>MENU MODE</u> Press: Up/Change Parameters
MENU	Press: Enter the Menu Hold: Switch Image Style <u>MENU MODE</u> Press: Confirm / Set Parameters Hold: Save and Exit the Menu
ZOOM	Press: Switch Magnification Hold: Enable/Disable PIP Mode <u>MENU MODE</u> Press: Down/Change Parameters

## 2.1.4 POWER ON AND OFF

### Power On

When the charged batteries are installed, hold the POWER button  to power on the device.

### NOTE

See the battery icon on the device display to check the battery charge. Icon  means the battery is fully charged, and icon  means that the battery is low. When the low power note shows, replace the batteries.

### Power Off

Hold the POWER button  to power off the device.

### Auto Power Off

In the "Auto Power Off" menu (see 2.2.33) you can set the time for the automatic shutdown of the device as required (OFF / 15 min / 30 min / 45 min).

The Auto Power Off countdown will start again when the device exits standby mode, or the device is restarted.

## 2.1.5 STANDBY MODE

Standby mode is used to save battery power. In this mode, some power-consuming features such as the display, network hardware, or internal storage will be temporarily disabled.

In the view mode, press the POWER button . After a few seconds, the display will turn off. Press the POWER button  again to exit the Standby mode.

When the Auto Screen Off function is enabled, you can also tilt or rotate the device to wake it from standby mode.

## 2.1.6 AUTO SCREEN OFF

Auto screen off function darkens the screen to save energy and increase battery time. However, the device stays on and you can view the live view on AGM Connect app when connecting the device to the app. The integrated algorithm automatically detects binocular's exact position and activates the auto screen-off function. The device will stand by automatically at a certain tilt angle or when it is stationary for more than 5 minutes (see paragraph 2.2.14 for details).

## 2.1.7 OBSERVATION

1. Open the objective lens caps.
2. Power on the binocular.
3. Hold the binocular and make sure the eyecups covers your eyes.
4. Press MODE button  and set the palette to display the scene with different effects in thermal or optical mode. When **Optical** mode is selected you can adjust the **Display Mode**. Hold MODE button to select the **DAY**, **NIGHT** or **AUTO** display mode.
5. Adjust the interpupillary distance by moving the eyepieces (Fig.2-3, A) farther or closer to each other.
6. Rotate the diopter adjustment rings (B) until the on-screen display (OSD) text or image is clear. Once completed, diopter adjustment will no longer be needed again until the device is used by a new user.

7. Point the device towards the target of the view. Bring the object into focus by rotate the objective focus rings (C).
8. In the optical NIGHT or AUTO mode slightly rotate the IR focus (D) to adjust the beam angle of the infrared light. The broader the beam angle is, the more spread-out but less intense the light will be.

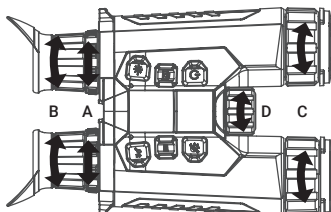

FIGURE 2-3. FOCUS ADJUSTMENT

**NOTE:**

You must perform the focus adjustment before any further use of the binocular.

8. For best observation effectiveness, set brightness, contrast, tone and scene mode using the device menu (for more information on these and other settings, see section 2.2).

**2.1.8 ON-SCREEN DISPLAY**

On-screen interface displays the main setup menu items and device status indicators. Adjust the On-Screen Display (OSD) in **Function Settings** menu (see 2.2.23). When OSD is on, the information of display mode, Wi-Fi hotspot activation, magnification, connection status, battery status, storage status, time and date displays on the screen.



FIGURE 2-4. ON-SCREEN DISPLAY

**2.1.9 PALETTE SETTINGS**

You can select different palettes to display the same scene in different effects. Press the MODE button (⊗) in live view interface to switch palettes. When the WHITE HOT, BLACK HOT, FUSION, or RED HOT mode is selected, the thermal channel image is displayed on the screen. When the OPTICAL mode is selected, the device switches to the digital optical channel.

TABLE 2-2. PALETTE SETTINGS

PALETTE	DESCRIPTION
WHITE HOT	The hot part is white-colored in view. The higher the temperature is, the lighter the color is.
BLACK HOT	The hot part is black-colored in view. The higher the temperature is, the more black the color is.
FUSION	From high temperature to low temperature, the image is colored in from white, yellow, red, pink to purple.
RED HOT	The hot part is red-colored in view. The higher the temperature is, the redder the color is.
OPTICAL	The image of optical channel is displayed in this mode.

### 2.1.10 SET DISPLAY MODE

You can select different display modes for optical channel.





When the OPTICAL palette is selected, hold down the MODE button  to switch the display modes between DAY, NIGHT or AUTO. The current mode is displayed on the left side of the display interface.

TABLE 2-3. DISPLAY MODE

SYMBOL	MODE	DESCRIPTION
	DAY	Full-color image for daytime. In DAY mode, the IR light is off automatically.
	NIGHT	Black & white viewing at night. In NIGHT mode, the IR light is on automatically.
	AUTO	The DAY mode and NIGHT mode switch automatically according to the ambient brightness.

In the NIGHT and AUTO modes the built-in infrared illuminator can be activated to clearly see in the total darkness. Set IR light in the main menu (according to 2.2.6) and focus the IR beam by rotating the IR focus knob.

### 2.1.11 DIGITAL ZOOM

You can zoom the image by using this function.

Press the ZOOM button  in the in viewing mode and the digital zoom will switch between 1x, 2x, 4x on ObservIR LRF 25-256 and 1x, 2x, 4x, 8x on ObservIR LRF 35-384 and ObservIR LRF 35-640. The current magnification value is displayed on the screen:

- AGM ObservIR LRF 25-256: 4.5x, 9x, 18x
- AGM ObservIR LRF 35-384: 4x, 8x, 16x, 32x
- AGM ObservIR LRF 35-640: 3x, 6x, 12x, 24x

Use the Zoom Pro feature in the main menu to enhance the details of the magnified image.

### 2.1.12 PICTURE IN PICTURE MODE

The Picture-in-Picture (PIP) mode allows you to see simultaneously both a magnified image of the central part in a PIP window and the main image. The PIP window is displayed at the up-center of the live view. In the live view you can enable or disable the PIP function by holding ZOOM button .

#### NOTES

If the PIP function is enabled, only the PIP view zooms when adjusting the digital zoom ratio.



If the PIP function is enabled in thermal mode, the PIP view only switches between current palette and optical mode; if the PIP function is enabled in optical mode, the PIP view switches among the selected palettes and optical mode.

### 2.1.13 IMAGE CALIBRATION

Hold the LRF button  in the view mode to release the shutter once for correction of the non-uniformity of display (see 2.2.26 for more information).

### 2.1.14 VIDEO RECORDING AND IMAGE CAPTURE

#### Video Recording

In the live view interface, hold the CAPTURE button  to start recording. Hold the CAPTURE button  again to stop recording.

#### Image Capture



In the live view interface press the CAPTURE button  to capture the image.

#### NOTE:

When capturing, the image freezes for 1 second and a prompt shows on the display.

### 2.1.15 DISTANCE MEASUREMENT

The device can detect the distance between the target and the observation position with built-in laser rangefinder.

Make the laser rangefinder settings in the menu (see details in part 2.2.11). Press the LRF button  to activate LRF. Point the square mark of the rangefinder at the target and press the LRF button  to measure the distance to the target.

You can scan the surroundings under **Continuous** mode. Continuous distance scanning will occur for a set time of 5, 10, 15, 30, or 60 seconds after pressing the LRF button .

The distance measurement result is displayed at the upper right of the image. Press the LRF button twice to turning off the laser.

### 2.1.16 CONNECTING THE DEVICE

1. Open the USB interface cover at the bottom of the binoculars.
2. Connect the device and power adapter with a USB Type-C cable to charge the battery while installed within the device. You can also supply power to the device using an external power system through the USB port. Alternatively, you may also connect the device to your computer using the included USB cable to copy/delete files.

The LED indicator near the Type-C port shows the charging status of the device:

- **Solid Red:** Charging.
- **Solid Green:** Fully charged.
- **Flashing Red & Green:** Error occurred.

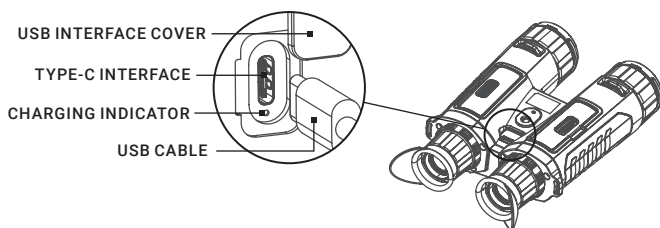

FIGURE 2-5. CABLE CONNECTION

### 2.1.17 EXPORT FILES

Before connecting the thermal binocular to a computer, please make sure that the Wi-Fi function of the binocular is disabled.

1. Hold the MENU button (Ⓜ) to show the menu.
2. Go to **Advanced Settings**, and press (⏏) or (⏪) button to select **Function Settings** menu and press the MENU button (Ⓜ) to confirm.
3. Press (⏏) or (⏪) button to select **USB Connection** submenu and press the MENU button (Ⓜ) to enter the configuration interface.
4. Press (⏏) or (⏪) button to select **USB Flash Drive**.
5. Hold the MENU button (Ⓜ) to exit a menu.
6. Connect the thermal binocular to your PC with USB cable and open the detected disk.

#### **NOTE:**

**Make sure the device is turned on when connecting the cable**

7. The directory is named by the current date. Enter DCIM > "Date" to view the videos and snapshots.
  - Select and copy the videos to PC and play the file with the player.
  - Select and copy the snapshots to PC and view the files.
8. Disconnect the device from your PC.

#### **NOTE:**

- The device displays images when you connect it to PC. But functions such as recording, capturing and hot spot are disabled.
- When you connect the device to PC for the first time, it installs the driver automatically.

### 2.1.18 EXPORT FILES VIA AGM CONNECT APP

You can access device albums and export files to your phone via AGM Connect App (see Section 2.3).



1. Open AGM Connect app and connect your device to the app.
2. Tap **Media** to access device albums.
3. Tap to select a file, and tap **Download** to export the file to your local phone albums.

### 2.1.19 TRIPOD ADAPTER

Use a tripod for long-time observation or at high magnification for effective image stabilization.

1. Align the tripod adapter screw (1) and guide (2) with the socket (3).
2. Rotate the tripod adapter knob (4) clockwise to fix the tripod adapter.

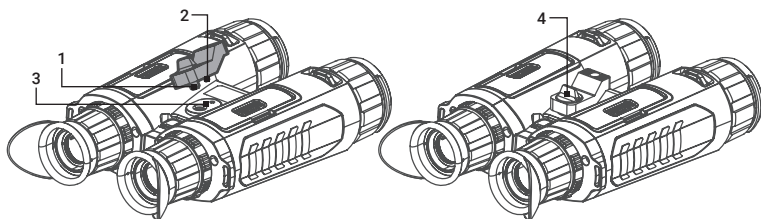

FIGURE 2-6. TRIPOD ADAPTER

## 2.2 MAIN FUNCTIONS

### 2.2.1 MAIN MENU

In the live view mode, press the MENU button (⊞) to display the Main Menu. In the Main Menu, you can set parameters such as Brightness, Contrast, Image Style, LED Light and also select the Advanced Settings menu for additional settings.

Press (⊞) or (⊞+) buttons to move between menu items. The active element is highlighted. Press the MENU button (⊞) to select menu item or change an option.

Hold the MENU button (⊞) to exit the menu.

































FIGURE 2-7. MAIN MENU

TABLE 2-4. MENU FUNCTIONS







MENU ITEM	SYMBOL	OPTION	FUNCTION
<b>BRIGHTNESS</b>		10 Levels of Brightness	Adjusts the image brightness.
<b>CONTRAST</b>		10 Levels of Contrast	Adjusts the image contrast.
<b>IMAGE STYLE</b>		<b>Image Style Menu:</b>	
Daylight		Brightness / Contrast / Tone / Sharpness / WDR	You can set and select different image styles in <b>Daylight</b> scenes.
Twilight		Brightness / Contrast / Tone / Sharpness / WDR	You can set and select different image styles in <b>Twilight</b> scenes.
Night Light		Brightness / Contrast / Tone / Sharpness / WDR	You can set and select different image styles in <b>Night Light</b> scenes.
<b>ZOOM PRO</b>		OFF / ON	Enables or disables the Zoom Pro function.
<b>LED LIGHT</b>		OFF / Smart IR / High / Medium / Low	Infrared light settings.
<b>ADVANCED SETTINGS</b>		<b>Advanced Settings Menu</b>	

TABLE 2-5. ADVANCED SETTINGS MENU







MENU ITEM	SYMBOL	OPTION	FUNCTION
TONE		Cold / Warm	Switch the thermal image tone between Cold and Warm.
SHARPNESS		5 Levels of Sharpness	Adjusts the thermal image sharpness.
SCENE MODE		Recognition / Jungle	Switch between the Recognition mode and Jungle mode.
WDR		OFF / ON	Provides better image quality in various lighting conditions (OPTICAL palette only).
LASER RANGING		Once / Continuous (5s, 10s, 15s, 30s, 60s)	LRF distance measurement settings.
NETWORK		Close / Hotspot	Enables or disables the Wi-Fi hotspot.
HOTSPOT BAND		2.4GHz / 5GHz	Hotspot band settings.
AUTO SCREEN OFF		OFF / ON	Darkens the screen to save energy.
AUDIO		OFF / ON	Enables or disables audio recording.
HOT TRACKING		OFF / ON	Enables or disables hot spot mark (marking the spot of highest temperature).
ALBUMS		View/Delete local files.	
CUSTOM PALETTES		Setting up the display of different palettes for selection.	
FUNCTION SETTINGS		Function Settings Menu:	
GPS		OFF / ON	Geographic Location Display.
COMPASS		OFF / ON	Enables or disables Compass. Magnetic declination correction.
OSD		OSD / Time / Date	Enables or disables OSD, time, date.
Brand Logo		OFF / ON	Enables or disables AGM logo on the screen.
USB Connection		USB Flash Drive/ Digital	USB port mode settings.
Image Calib.		Auto / Semi-Auto / Manual	Selecting the Flat Field Correction (FFC) mode.
DPC		Axis: X/Y	Correction of dead pixel manually.
Burn Prevention		OFF / ON	Enables or disables the Burn Prevention function.

MENU ITEM	SYMBOL	OPTION	FUNCTION
<b>GENERAL SETTINGS</b>		<b>General Settings Menu:</b>	
Language		23 Languages	Choice of interface language.
Time		12 / 24 hour	Time setting.
Date		Month/Day/Year	Date setting.
Unit		yard / m	Sets the distance unit.
Auto Power Off		OFF / 15 min / 30 min / 45 min	Setting the automatic shutdown time.
Restore		---	Restoring the default device settings.
Format		Current free space	Format the internal storage.
Version		---	Firmware version and serial number.

## 2.2.2 BRIGHTNESS ADJUSTMENT









1. Press the MENU button  to call the Main Menu.
2. Select  **Brightness** menu item and press the MENU button  to confirm.
3. Press  or  buttons to adjust the brightness. You can select one of ten levels of the brightness to adjust the image lighter or darker.
4. Hold the MENU button  to exit.





## 2.2.3 CONTRAST ADJUSTMENT

1. Press the MENU button  to call the Main Menu.
2. Select  **Contrast** menu item and press the MENU button  to confirm.
3. Press  or  buttons to adjust the image contrast. You can select one of ten levels of the contrast.
4. Hold the MENU button  to exit.

## 2.2.4 IMAGE STYLE

You can adjust and select different image styles in different light conditions for better viewing experience and image quality.

1. Press the MENU button  to call the Main Menu.
2. Select  **Image Style** menu item and press the MENU button  to enter the image style interface. Press  or  button to select the image style between **Daylight**, **Twilight** and **Night Light**.
  -  **Daylight**: You can use this style at daytime and in bright environment.
  -  **Twilight**: You can use this style at twilight.
  -  **Night Light**: You can use this mode at night.
3. You can set parameters for different styles according to your preferences. Select one of the image styles and press the MENU button  to enter the setting interface.

4. Press  or  button to select parameters, including brightness, contrast, tone, sharpness, and WDR. Then press  to set parameters as required.
5. Hold the MENU button  to exit according to the prompt.
  - **OK:** Save all parameters and exit.
  - **CANCEL:** Exit and not save the parameters.
6. Hold the MENU button  in the live view interface to switch the image styles.









#### **NOTE**

WDR takes effect only in optical mode. Sharpness and tone takes effect only in thermal mode.

If you set the parameters such as brightness, contrast, tone, sharpness, and WDR in the menu rather than in the image style settings, the device will prompt you to save the current style when you switch styles in the live view interface.

### **2.2.5 ZOOM PRO**

When you turn on Zoom Pro function, the details of zoomed image will be enhanced.







1. Press the MENU button  to call the Main Menu.
2. Press  or  button to select  Zoom Pro menu item and press the button  to enable or disable Zoom Pro mode.
3. Press  or  to select other item or hold the MENU button  to exit a menu.

#### **NOTES:**

If the PIP function is enabled, zoom pro is only enabled in the PIP view. Zoom Pro cannot be enabled when device battery is low.

### **2.2.6 LED LIGHT**

The built-in infrared illuminator can be activated to clearly see in the total darkness. The infrared light only works in NIGHT and AUTO display modes when OPTICAL palette is activated.

1. Press the MENU button  to call the Main Menu.
2. Press  or  to select  LED LIGHT menu and press  to confirm.
3. Press  or  to select the IR light level between **Low**, **Medium** or **High** or set the **Smart IR** mode. Select **OFF** to turn off the IR light.

#### **NOTE**

The image might be overexposed when the environment is too bright. The Smart IR function adjusts the overexposed images by controlling infrared light intensity, so as to improve the image effect in night mode and dark environment.













4. Press  to save settings and exit.

#### **NOTE**

Infrared light cannot be turned on if the battery is low. The infrared light is off in the thermal mode or standby mode.













## 2.2.7 IMAGE TONE SETTING

This function allows you to change the tone of thermal image to warm or cold.

1. Press the MENU button  to call the Main Menu.
2. Go to  **Advanced Settings**, then press  or  button to select  **Tone** menu item and press the MENU button  to confirm.
3. Press  or  button to select **Warm** or **Cold** tone and press the MENU button  to confirm.
4. Press  or  to select other item or hold the MENU button  to exit a menu.









## 2.2.8 SHARPNESS SETTING

This function allows you to adjust the sharpness of the thermal image.

1. Press the MENU button  to call the Main Menu.
2. Go to  **Advanced Settings**, press  or  button to select  **Sharpness** menu item and press the MENU button  to confirm.
3. Press  or  button to adjust the image sharpness. You can select one of five levels of the image sharpness. Press the MENU button  to confirm.
4. Press  or  to select other item or hold the MENU button  to exit a menu.





## 2.2.9 SCENE MODE

You can select proper **Scene Mode** according to environment temperature to improve the display effect.

1. Press the MENU button  to call the Main Menu.
2. Go to  **Advanced Settings**, press  or  button to select  **Scene Mode** menu item and press the MENU button  to confirm.
3. Press  or  button to switch scene mode:







**Recognition mode:** improves an image so that the object edge is more distinct.

**Jungle mode:** is more suitable for hunting environment because of the highlight function of small objects.

4. Press the MENU button  to confirm.
5. Press  or  button to select other item or hold the MENU button  to exit a menu.













## 2.2.10 WDR

WDR (Wide Dynamic Range) enhances the viewing experience in the Optical channel, providing better image quality in diverse lighting conditions. When this feature is enabled, it prevents excessive brightness in light areas and increases shadow detail.

1. Press the MENU button  to show the menu.
2. Go to  **Advanced Settings**, and press  or  to select  **WDR** menu.
3. Press the MENU button  to enable or disable the WDR function.
4. Hold the MENU button  to exit.







### 2.2.11 SET LASER RANGING

The device can detect the distance between the target and the observation position with built-in laser rangefinder.

1. Press the MENU button  to call the Main Menu.
2. Go to  **Advanced Settings**, press  or  to Select the  **Laser Ranging** menu item and press the MENU button  to confirm.
3. Press  or  button to select the laser ranging mode between **Once** and **Continuous (5s)**, **Continuous (10s)**, **Continuous (15s)**, **Continuous (30s)**, **Continuous (60s)**. Press the MENU button  to set selected mode.
4. Press  or  to select other item or hold the MENU button  to exit a menu.

### 2.2.12 NETWORK CONFIGURATION

Connect your phone to the WiFi hotspot of the binocular, and you can configure the parameters and realize functions of the device.









1. Press the MENU button  to call the Main Menu.
2. Go to  **Advanced Settings** and press  or  button to select the  **Network** menu item. Press the MENU button  to enable or disable WiFi hotspot. When WiFi is turned on, the WiFi hotspot password is displayed on the screen.
3. Open the AGM Connect App and connect your phone with the device (refer to Section 2.3). You can view the interface of binocular on your phone.
4. Hold the MENU button  to exit.

#### **NOTE:**

When the power is less than 15%, the WiFi hotspot function will be turned off automatically.

### 2.2.13 HOTSPOT BAND

This feature allows to select the WiFi band and helps solve smartphone connection issues and improve the connection between the device and the smartphone.

1. Press the MENU button  to call the Main Menu.
2. Go to  **Advanced Settings** and press  or  to select the  **Hotspot Band** menu item. Press the MENU button  to enter the setting interface.
3. Press  or  button to switch 2.4 GHz or 5 GHz hotspot bandwidth.
4. Press the MENU button  to confirm and exit.

### 2.2.14 AUTO SCREEN OFF

Auto Screen Off function darkens the screen to save energy and increase battery time. However, the device stays on and you can view the live view on AGM Connect app when connecting the device to the app.

1. Press the MENU button  to call the Main Menu.

- Go to **Advanced Settings** and press or button to select **Auto Screen Off** menu item. Press the MENU button to enable or disable Auto Screen Off function.
- Press or to select other item or hold the MENU button to exit a menu.

You can use one of the following methods to enter the standby mode when the display is turned on:

- Tilt the device downwards more than 70°.
- Rotate the device horizontally more than 75°.
- Keep the device still and do not move it for 5 minutes.

You can use one of the following methods to wake up the device when the display is turned off:

- Tilt the device downwards from 0° to 60° or upwards .
- Rotate the device horizontally from 0° to 75°.
- Press POWER button to wake up the device.

#### **NOTE**

After enabling the auto screen off, when you enter the menu, the auto screen off does not take effect until you exit the menu.

### **2.2.15 AUDIO RECORDING SETTING**

The **Audio** function allows you to record sound along with video. If there is too much noise when recording, this function can be disabled.

- Press the MENU button to call the Main Menu.
- Go to **Advanced Settings** and press or button to select **Audio** menu item. Press the MENU button to enable or disable this function.
- Press or button to select other item or hold the MENU button to exit a menu.

### **2.2.16 HOT TRACKING**

The device can detect the highest temperature spot in the scene and mark it on display.

- Press the MENU button to call the Main Menu.
- Go to **Advanced Settings** and press or button to select **Hot Tracking** menu item. Press the MENU button to enable/disable hot spot mark (marking the spot of highest temperature).
- Press or button to select other item or hold the MENU button to exit a menu.

When the hot spot mark is enabled, the green cross mark displays in the spot of the highest temperature. When the scene changes, the green mark moves.

### **2.2.17 ALBUMS**

Captured images and recorded videos are automatically stored in the device, and you can view the files in local albums.







- Press the MENU button to call the Main Menu.





2. Go to  **Advanced Settings**, press  or  to Select the  **Albums** menu item and press the MENU button  to confirm.



#### **NOTE:**

The albums are automatically created and named by year + month. The local pictures and videos of a certain month are stored in the corresponding album. For example, the pictures and videos of August in 2024 are saved in the album named "202408".

3. Press  or  button to select the album, and press the MENU button  to enter the selected album.
4. Press  or  button to select a file to view.
5. Press the MENU button  to view the selected file and relevant information.

#### **NOTE:**

Files are arranged in chronological order, with the most recent at the top. If you fails to find the most recently taken snapshots or videos, please check the time and date settings of your device. When you are viewing files, you can switch to other files by pressing  or .









When you are viewing files, you can press  to turn to next page, and press  to go back to previous page.

When you are viewing videos, you can press  to play or stop the video.

For deleting an album or a file, you can hold  to call the dialogue box, and delete the album or file according to the prompt.

## **2.2.18 CUSTOM PALETTES**

You can select different palettes to display the same scene in different effects. In the **Custom Palettes** menu you can select palettes that will be cycled through when you press the MODE button  in live view interface.

1. Press the MENU button  to call the Main Menu.
2. Go to  **Advanced Settings** and press  or  to select the  **Custom Palettes** menu.
3. Press the MENU button  to go to the palettes interface.
4. Press  or  button to select the palette required, and press the MENU button  to enable or disable it.





#### **NOTE**







At least one palette should be enabled.

5. Hold the MENU button  to exit.

## **2.2.19 GPS**

Equipped with satellite positioning modules, the device is able to display the longitude and latitude, as well as the sea level altitude of the device on the live image, captured images, and recorded videos.

1. Press the MENU button  to call the Main Menu.
2. Go to  **Advanced Settings** and press  or  to select the  **Function Settings**.

3. Press  or  button to select  GPS menu item, and press the MENU button  to enable or disable GPS.
4. Press  or  button to select other item or hold the MENU button  to exit a menu.













When GPS is enabled you can see the location information displayed at the lower right corner of the screen (see Figure 2-4). The message "Weak Signal" in this place, indicates the signal is weak or no signal. Please move to the open outdoor space and try again.

**NOTE:**

- The satellite module is not able to receive signals when the device is indoor. Place the device in an empty outdoor space to receive signals.
- In an outdoor space, wait for a moment for the device to display its location.

## 2.2.20 COMPASS

Equipped with a compass, the device is able to display its direction on the live image, captured images, and recorded videos.

1. Press the MENU button  to call the Main Menu.
2. Go to  **Advanced Settings** and press  or  to Select the  **Function Settings**.
3. Press  or  button to select  **Compass** menu item, then press the MENU button  to enter the compass interface.
4. Press  or  button to select **Compass** and press the MENU button  to enable or disable the magnetic compass.
5. Follow the pop-up instructions to calibrate the compass. See **Calibrate Compass** or more information.

After successful calibration, you can see the direction information displayed at the bottom of the screen. It is recommended to read the direction when you lay the device horizontally.

To increase the direction accuracy, you can set the magnetic declination correction. See part 2.2.22 Magnetic Declination Correction for instructions.

## 2.2.21 CALIBRATE COMPASS

Calibrating the compass is necessary to display the correct direction.

You need to calibrate the compass when you enable the function for the first time, or when the compass is magnetically interfered, and the direction information displays red.

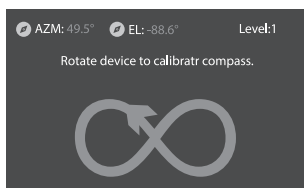



FIGURE 2-8. CALIBRATE COMPASS

1. Call the calibration guide by the following ways.
  - When you enable compass for the first time, the compass calibration guide pops up.
  - When the compass information displays red, select  **Compass** in menu mode and press the MENU button  to re-enable compass.
2. Follow the screen instructions to move and rotate the device.

**NOTE:**









During calibration, keep moving and rotating the device to make sure that the device faces every possible directions.

Calibration Level indicates the validity of calibration. Higher level means more accurate compass reading. Calibration succeeds when the Calibration Level turns to 3.

3. Stop moving the device when calibration success message pops up. The direction information is displayed on the up right of the live view image.

## 2.2.22 MAGNETIC DECLINATION CORRECTION

Magnetic declination is the angle variation between magnetic north and true north. Adding the magnetic declination to the compass increase the accuracy of direction reading.











1. After the compass is calibrated, go to the compass setting interface and select **Magnetic Declination**.
2. Press the MENU button  to enter the setting interface, and press  or  to select **Quick Correction** or **Manual Correction**.
  - In Quick Correction, the device displays the current declination to magnetic north. Point the binoculars to true north and press the MENU button .
  - In Manual Correction, press the MENU button  to select the operational symbol or number, and then press  or  button to add or subtract the declination of device location.
3. Hold the MENU button  to save and exit.

**NOTE**

It is recommended to check the local magnetic declination information on the authorized website before manually correcting the magnetic declination. The eastern magnetic declination is indicated with a positive mark (+), and the western declination is indicated with a negative mark (-).

## 2.2.23 ON-SCREEN DISPLAY (OSD)

You can choose which OSD information to display in the live view user interface. Options include, WiFi hotspot activation, current magnification, memory storage status, battery indicator status, time and date. These will appear at the top of the display interface when activated.

1. Press the MENU button  to call the Main Menu.
2. Go to  **Advanced Settings** and press  or  button to select  **Function Settings** menu. Press the MENU button  to confirm.
3. Press  or  button to select  **OSD** submenu and press the MENU button  to enter.

4. Press or button to select the **OSD, Time or Date**. Press the MENU button to display or hide the necessary information.
5. Hold the MENU button to exit OSD menu.

### 2.2.24 BRAND LOGO

You can display the AGM logo in the lower left corner of the screen.

1. Press the MENU button to call the Main Menu.
2. Go to **Advanced Settings** and press or button to select **Brand Logo** menu item. Press the MENU button to enable/disable logo.
3. Press or to select other item or hold the MENU button to exit a menu.

### 2.2.25 USB CONNECTION

The USB port can be used to transfer data to a PC, charge the installed batteries, or casting screen to PC by UVC protocol-based client software or player. You can view the device screen image on the monitor to get a better and clearer image, more convenient to checking the details.

1. Press the MENU button to call the Main Menu.
2. Go to **Advanced Settings**, and press or button to select **Function Settings** menu and press the MENU button to confirm.
3. Press or button to select **USB Connection** submenu and press the MENU button to enter the configuration interface.
4. Press or button to select **USB Flash Drive** for transfer data or charge the battery, or **Digital** to casting screen to PC.
5. Hold the MENU button to exit a menu.

### 2.2.26 IMAGE CALIBRATION





The image calibration function performs what is known as the Flat Field Correction or FFC. This is required of all thermal devices. This can correct for non-uniformity of the display. During correction an internal shutter will be lowered in front of the thermal detector. A “click” sound will often be heard, and the image is momentarily interrupted for a split second. After this quick process the detector will be re-calibrated, and the image becomes more accurate. AGM recommends automatic when scanning for game or targets. However, we recommend going into the menu and changing to Manual correction mode when getting close making your shot. This will prevent any unwanted auto-correction occurring when tracking live game. This will help shooters in making ethical shot placements at all times.

1. Press the MENU button to call the Main Menu.
2. Go to **Advanced Settings** and press or button to select **Function Settings** menu and press the MENU button to confirm.
3. Press or button to select **Image Calib.** submenu and press the MENU button to enter.
4. Press or button to switch the FFC mode.

**Auto:** The binocular performs FFC automatically when switching on or rebooting the camera.

**Semi-Auto:** Press the MODE button  in live view to correct the non-uniformity of display.















**Manual:** Cover the lens cap, then press the MODE button  in live view to correct the non-uniformity of display.

5. Press the MENU button  to confirm.
6. Press  or  to select other item or hold the MENU button  to exit a menu.

## 2.2.27 DEFECTIVE PIXELS CORRECTION













The Defective Pixel Correction (DPC) can help users repair the occasional deactivated pixel within the display. This is fairly common in thermal optics, which is why so many of these optics come equipped with a DPC feature. 1-3 dead pixels are usually easily repaired by the user. Anything over 3 that cannot be repaired, will open the unit up to an approved warranty repair by AGM at their facility.

Before you start switch the palette to White Hot mode.

1. Press the MENU button  to call the Main Menu.
2. Go to  **Advanced Settings**, and press  or  button to select  **Function Settings** menu and press the MENU button  to confirm.
3. Press  or  button to select  **DPC** submenu and press the MENU button  to enter.
4. Press the MENU button  to select the X or Y axis.
5. Press  or  button to set the coordinates until the cursor reaches the dead pixel.
6. Press the MENU button  twice to correct the dead pixel.
7. (Optional) Repeat 4 to 6 to correct the position for other dead pixels.
8. Hold the MENU button  to exit a menu.

## 2.2.28 BURN PREVENTION

This function can prevent damage to the thermal sensor from the sun or other high temperature bright light sources. When enabling this function, the shield will close until the environment turns to normal. This feature may be useful to help protect sensitive displays during extreme summer temperatures. AGM recommends all units be stored in room temperature whenever possible, as long periods of storage in extreme heat (such as inside a vehicle) may lead to issues with the display materials.

1. Press the MENU button  to call the Main Menu.
2. Go to  **Advanced Settings** and press  or  button to select  **Function Settings** menu and press the MENU button  to confirm.
3. Press  or  button to select  **Burn Prevention** submenu and press the MENU button  to enable or disable the Burn Prevention function.
4. Press  or  to select other item or hold the MENU button  to exit a menu.

## 2.2.29 LANGUAGE SETTING

You can select different languages of user interface.

1. Enter the  **Advanced Settings** menu.

2. Press or button to select **General Settings** and press the MENU button to confirm.
3. Press or button to select **Language** submenu and press the MENU button to enter.
4. Press or button to select the language as required and press the MENU button to confirm.
5. Hold the MENU button to exit.

### 2.2.30 TIME SETTING

1. Enter the **Advanced Settings** menu.
2. Press or button to select **General Settings** and press the MENU button to confirm.
3. Press or button to select **Time** submenu and press the MENU button to enter the configuration interface.
4. Press the MENU button to select the 24-hour or 12-hour clock system, or hour and minute to be synchronized and press or button to change.
5. Hold the MENU button to exit.

### 2.2.31 DATE SETTING

1. Enter the **Advanced Settings** menu.
2. Press or button to select **General Settings** and press the MENU button to confirm.
3. Press or button to select **Date** submenu and press the MENU button to enter the configuration interface.
4. Press the MENU button to select the month, day or year to be synchronized and press or button to change the number.
5. Hold the MENU button to exit.

### 2.2.32 UNIT SETTING

You can set the unit (yards or meters) of measurement for distance.

1. Enter the **Advanced Settings** menu.
2. Press or button to select **General Settings** and press the MENU button to confirm.
3. Press or button to select **Unit** submenu and press the MENU button to enter the configuration interface.
4. Press or button to select Yard or Meter and press the MENU button to confirm.

### 2.2.33 AUTO POWER OFF









You can set the time for the automatic shutdown of the device as required.

1. Enter the **Advanced Settings** menu.
2. Press or button to select **General Settings** and press the MENU button to confirm.
3. Press or button to select **Auto Power Off** submenu and press the MENU button to enter the configuration interface.

4. Press  or  button to select OFF, 15 min, 30 min or 45 min and press the MENU button  to confirm.











### 2.2.34 RESTORE DEVICE

You can reset your device to its default settings.

1. Enter the  **Advanced Settings** menu.
2. Press  or  button to select  **General Settings** and press the MENU button  to confirm.
3. Press  or  button to select  **Restore** and press the MENU button . The window "Initialize?" will appear.
  - **OK**: Restore the device to defaults.
  - **CANCEL**: Exit without changing the settings.









### 2.2.35 FORMAT

You can see free space of built-in storage and format the storage for delete all recorded files.

1. Enter the  **Advanced Settings** menu.
2. Press  or  button to select  **General Settings** and press the MENU button  to confirm.
3. Press  or  button to select  **Format** menu item. Information about the free space of the built-in storage will be displayed. To format the storage, press the MENU button . The window "Initialize?" will appear.
4. Select OK and press the MENU button  to format the storage. A prompt will pop up when the formatting is completed.
5. Select CANCEL and press the MENU button  to exit without changes.

### 2.2.36 VERSION

You can view the device information such as firmware version and serial number.

1. Enter the  **Advanced Settings** menu.
2. Press  or  button to select  **General Settings** and press the MENU button  to confirm.
3. Press  or  button to select  **Version** item and press the MENU button  to confirm. The firmware version and serial number will be displayed.

## 2.3 CLIENT SOFTWARE INTRODUCTION

Search the AGM Connect software in App Store (iOS System) or Google Play™ (Android System) and install the application on your mobile phone. Turn on the Wi-Fi hotspot on the thermal device and then connect your phone to the hotspot.



- Hotspot Name: Wlan-<Serial No.>

- Hotspot Password: When WiFi is turned on, the hotspot password is displayed on the screen of the binoculars.

### NOTE:

The device password is set by user at first activation. If the password was lost or forgotten, it can be reset. To reset a password perform the following steps:

1. When the thermal device is turned on, hold the MENU button  to activate the Main menu.

2. Select  Restore item in the General Settings menu and press the MENU button  to restore all parameters to default settings.

1. Run the app and connect the phone or tablet with the device.

2. If the device is inactivated, set the password and activate it. If the device is activated, enter the password to add it to the app.

3. When the device is added, the live view can be seen. You can view the interface of the device on the software. User can change such image parameters as brightness, contrast, zoom, palettes directly via phone or tablet as well as record video on phone/tablet memory.

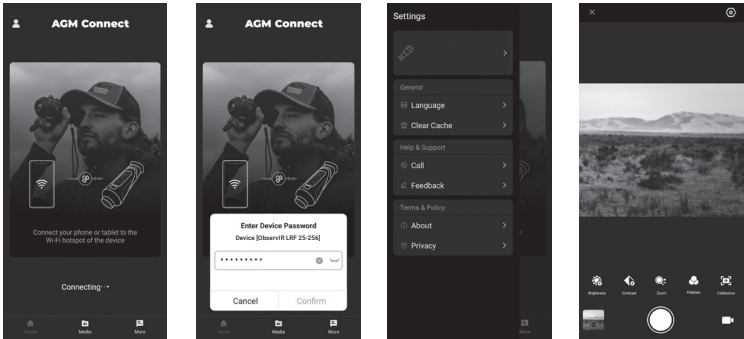

FIGURE 2-9. AGM CONNECT APP



# 3 MAINTENANCE

## 3.1 MAINTENANCE

### 3.1.1 CLEANING PROCEDURES

1. Gently brush off any dirt from the body of the device using a clean, soft cloth.
2. Moisten the cloth with fresh water and gently wipe down the external surfaces (except lenses).
3. Dry any wet surfaces (except lenses) using another dry, clean, soft cloth.
4. Using a lens brush, carefully remove all loose dirt from the lenses.
5. Dampen a cotton swab with ethanol and slowly, gently wipe down the lenses. Clean the glass surfaces using circular movements, starting from the center of the lens and moving out towards the edge, without touching the lens holder. Change the cotton swab after each circular stroke. Repeat this step until the glass surfaces are clean.
6. Clean the accessories with a soft brush (or cloth) dampened with soap and water.

### 3.1.2 PREPARING FOR EXTENDED STORAGE

#### **CAUTION:**

Thoroughly dry each item before placing them into the storage case.

To prepare the device for extended storage:

1. Clean the device and accessories.
2. Place all items into the storage case.
3. Make sure to remove the battery from the unit.

### 3.1.3 UPDATING THE DEVICE FIRMWARE

#### **WARNING:**

Please make sure the device is connected to the computer during the entire update process. Otherwise, it may cause unnecessary upgrade failure, firmware damage, etc.

1. Visit [www.agmglobalvision.com/firmware](http://www.agmglobalvision.com/firmware) website. Select your product, download the firmware update package to your PC and unzip it. Follow the detailed instructions on the website.
2. Connect the device to your PC with USB cable.
3. Turn on the device. Make sure the Wi-Fi hotspot function is disabled.
4. Open the detected disk (USB drive) in file manager program. Copy the unzipped `digicap.dav` file and paste it to the root directory of the device.

5. Turn off the device completely, then power it back on. After awhile, the firmware update process will start automatically. During the update, the screen will display the inscription “Upgrading...”. The update process will be completed when the inscription “Upgrading...” goes out.

6. Turn off the device and disconnect it from your PC.

You can also enjoy automatic update function in AGM Connect App (see section 2.3 for details).

1. Start the AGM Connect App and tap the Settings icon in the left top corner.

2. Tap your device in the device list. The information about your device will be shown.

3. Tap **Checking for Upgrade** to detect and download the latest FW version.

## 3.2 TROUBLESHOOTING

Table 3-1 lists the most common malfunctions that may occur with your equipment. This table does not list all the malfunctions that may occur with your device. If the equipment malfunction is not corrected by the suggested actions, or a problem occurs that is not listed in this table, please contact AGM Global Vision’s Customer Support center or your retailer.

TABLE 3-1. TROUBLESHOOTING

MALFUNCTION	CORRECTIVE ACTION
The binocular fails to activate.	<ol style="list-style-type: none"> <li>1. Batteries are missing or improperly installed. Insert batteries or install correctly.</li> <li>2. Batteries are dead. Replace the batteries.</li> <li>3. Batteries, surfaces or contacts are dirty or corroded. Clean the contacts.</li> </ol>
Device power indicator is off.	Examine whether the device is off-battery.
The image of the binocular is not clear.	Perform the binocular adjustment referring to section 2.1.
Wi-Fi is not found.	Examine whether the Wi-Fi function is turned on. If not, go to OSD menu and turn on Wi-Fi.
Image capture or video recording fails.	<p>Examine the items below:</p> <ol style="list-style-type: none"> <li>1. Whether the device is connected to your PC and disabled the capture and recording.</li> <li>2. Whether the storage space is full.</li> <li>3. Whether the device is low-battery.</li> </ol>
The PC cannot identify the binocular.	<p>Examine the items below:</p> <ol style="list-style-type: none"> <li>1. Whether the device is connected to your PC with standard USB cable.</li> <li>2. If you use other USB cables, make sure the cable length is no longer than 1 m.</li> </ol>

# 4 WARRANTY INFORMATION

## 4.1 WARRANTY INFORMATION AND REGISTRATION

The below description of AGM Global Vision warranty terms and conditions refer specifically to AGM branded products purchased within the United States. Customers purchasing AGM products outside the United States can obtain specific information about their product's warranty term on the [www.agmglobalvision.eu](http://www.agmglobalvision.eu) website.

### 4.1.1 WARRANTY INFORMATION

This product is guaranteed to be free from manufacturing defects in material and workmanship under normal use for a period of three years for ObservIR LRF 25-256 model and five (5) years for ObservIR LRF 35-384 and ObservIR LRF 35-640 models from the date of purchase. In the event that a defect covered by the warranty below occurs during the applicable period stated above, AGM Global Vision, at its discretion, will either repair or replace the product; such action on the part of AGM Global Vision shall be the full extent of AGM Global Vision's liability, and the Customer's sole and exclusive repair. This warranty does not cover a product if it has been (a) used in ways other than its normal and customary manner; (b) subjected to misuse; (c) subjected to alterations, modifications or repairs by the Customer or by any party other than AGM Global Vision without prior written consent of AGM Global Vision; (d) is the result of a special order or categorized as "close-out" merchandise or merchandise sold "as-is" by either AGM Global Vision or the AGM Global Vision dealer; or (e) merchandise that has been discontinued by the manufacturer and either parts or replacement units are not available due to reasons beyond the control of AGM Global Vision. AGM Global Vision shall not be responsible for any defects or damage that in AGM Global Vision's view are a result from the mishandling, abuse, misuse, improper storage or improper operation of the device, including use in conjunction with equipment that is electrically or mechanically incompatible with, or of inferior quality to, the product, as well as failure to maintain the environmental conditions specified by the manufacturer. This warranty is extended only to the original purchaser. Any breach of this warranty shall be enforced unless the customer notifies AGM Global Vision at the address noted below within the applicable warranty period.

The customer understands and agrees that except for the foregoing warranty, no other warranties written or oral, statutory, expressed or implied, including any implied warranty of merchantability or fitness for a particular purpose, shall apply to the product. All such implied warranties are hereby and expressly disclaimed.

### 4.1.2 LIMITATION OF LIABILITY

AGM Global Vision will not be liable for any claims, actions, suits, proceedings, costs, expenses, damages, or liabilities arising out of the use of this product. Operation and use of the product are the sole responsibility of the Customer. AGM Global Vision's sole undertaking is limited to providing the products

and services outlined herein in accordance with the terms and conditions of this Agreement. The provision of products sold and services performed by AGM Global Vision to the Customer shall not be interpreted, construed, or regarded, either expressly or implied, as being for the benefit of or creating any obligation toward any third party of legal entity outside AGM Global Vision and the Customer; AGM Global Vision's obligations under this Agreement extend solely to the Customer. AGM Global Vision's liability hereunder for damages, regardless of the form or action, shall not exceed the fees or other charges paid to AGM Global Vision by the customer or customer's dealer. AGM Global Vision shall not, in any event, be liable for special, indirect, incidental, or consequential damages, including, but not limited to, lost income, lost revenue, or lost profit, whether such damages were foreseeable or not at the time of purchase, and whether or not such damages arise out of a breach of warranty, a breach of agreement, negligence, strict liability, or any other theory of liability.

#### **4.1.3 PRODUCT REGISTRATION**

In order to validate the warranty on your product, the customer must complete and submit AGM Global Vision PRODUCT REGISTRATION FORM on our website ([www.agmglobalvision.com/customer-support](http://www.agmglobalvision.com/customer-support)).

#### **4.1.4 OBTAINING WARRANTY SERVICE**

To obtain warranty service on your unit, the End-user (Customer) must notify the AGM Global Vision service department via e-mail. Send any requests to [support@agmglobalvision.com](mailto:support@agmglobalvision.com) to receive a Return Merchandise Authorization number (RMA). When returning any device, please take the product to your retailer, or send the product, postage paid and with a copy of your sales receipt, to AGM Global Vision's service center at the address listed above. All merchandise must be fully insured with the correct postage; AGM Global Vision will not be responsible for improper postage or merchandise that becomes lost or damaged during shipment. When sending product back, please clearly write the RMA# on the outside of the shipping box. Please include a letter that indicates your RMA#, the Customer's Name, a Return Address, reason for the return, contact information (valid telephone numbers and/or an e-mail address), and proof of purchase that will help us to establish the valid start date of the warranty. Product merchandise returns that do not have an RMA# listed may be refused, or a significant delay in processing may occur. Estimated Warranty service time is 10-20 business days. The End-user/Customer is responsible for postage to AGM Global Vision for warranty service. AGM Global Vision will cover return postage/shipping after warranty repair to the End-user/Customer only if the product is covered by the aforementioned warranty. AGM Global Vision will return the product after warranty service by domestic UPS Ground service and/or domestic mail. Should any other requested, required, or international shipping methods be necessary, the postage/shipping fee will be the responsibility of the End-user/Customer.

For service, repair or replacement, please contact:

#### **AGM Global Vision, LLC**

173 West Main Street

PO Box 962

Springerville, AZ 85938

Tel. 928.333.4300

[support@agmglobalvision.com](mailto:support@agmglobalvision.com)

[www.agmglobalvision.com](http://www.agmglobalvision.com)

# 5 SPECIFICATIONS

## 5.1 SPECIFICATIONS

	ObservIR LRF 25-256	ObservIR LRF 35-384	ObservIR LRF 35-640
Thermal Detector	12µm VOx Uncooled Focal Plane Array	12µm VOx Uncooled Focal Plane Array	12µm VOx Uncooled Focal Plane Array
Thermal Resolution	256 × 192	384 × 288	640 × 512
Refresh Rate	50 Hz	50 Hz	50 Hz
NETD	Less than 35 mK (25°C, F#=1.0)	Less than 20 mK (25°C, F#=1.0)	Less than 20 mK (25°C, F#=1.0)
Thermal Channel Lens System	25 mm; F1.0	35 mm; F1.0	35 mm; F1.0
Thermal Channel Field of View	7.0° × 5.3°	7.5° × 5.7°	12.5° × 10.1°
Thermal Channel Magnification	4.5x – 18x	4x – 32x	3x – 24x
Digital Zoom	1x, 2x, 4x	1x, 2x, 4x, 8x	1x, 2x, 4x, 8x
Diopter Adjustment	-5 to +3	-5 to +3	-5 to +3
Detection Range (6' object)	1,200 m	1,800 m	1,800 m
Monitor	1920×1080, 0.49", OLED, 50 FPS	1920×1080, 0.49", OLED, 50 FPS	1920×1080, 0.49", OLED, 50 FPS
FFC (Flat Field Correction)	Auto, Manual, External Correction	Auto, Manual, External Correction	Auto, Manual, External Correction
Palettes	Black Hot, White Hot, Red Hot, Fusion	Black Hot, White Hot, Red Hot, Fusion	Black Hot, White Hot, Red Hot, Fusion
Highest Temperature Spot Tracking	Yes	Yes	Yes
Scene Mode	Jungle, Recognition	Jungle, Recognition	Jungle, Recognition
Optical Digital Sensor	3840×2160, 1/88" Progressive Scan CMOS	3840×2160, 1/88" Progressive Scan CMOS	3840×2160, 1/88" Progressive Scan CMOS

	ObservIR LRF 25-256	ObservIR LRF 35-384	ObservIR LRF 35-640
Optical Channel Magnification	5.5x – 22x	5.5x – 22x	5.5x – 22x
Optical Channel Field of View	6.9° × 4.1°	6.9° × 4.1°	6.9° × 4.1°
Optical Module Lens System	60 mm, F2.2	60 mm, F2.2	60 mm, F2.2
Display Mode	Day, Night, Auto	Day, Night, Auto	Day, Night, Auto
Distance Measurement	Laser Rangefinder: up to 1,000 m, ±1 m accuracy	Laser Rangefinder: up to 1,000 m, ±1 m accuracy	Laser Rangefinder: up to 1,000 m, ±1 m accuracy
Laser Wavelength	905 nm	905 nm	905 nm
Laser Safety Class	Class 1	Class 1	Class 1
Infrared Light	Built-in 850nm Smart IR. Power and beam angle adjustment	Built-in 850nm Smart IR. Power and beam angle adjustment	Built-in 850nm Smart IR. Power and beam angle adjustment
Viewing Range at Night	400 m	400 m	400 m
Wi-Fi Hotspot	Yes	Yes	Yes
Sleep Mode	Yes	Yes	Yes
Built-in Storage	64 GB EMMC	64 GB EMMC	64 GB EMMC
Video/Audio Recording	Yes / Yes	Yes / Yes	Yes / Yes
Image Capture	Yes	Yes	Yes
Interpupillary Adjustment Range	60 mm to 74 mm	60 mm to 74 mm	60 mm to 74 mm
Battery Type	Two 18650 rechargeable battery (removable)	Two 18650 rechargeable battery (removable)	Two 18650 rechargeable battery (removable)
Battery Life	Up to 8 hours continuous running (@25°C, WiFi, IR and LRF off)	Up to 6 hours continuous running (@25°C, WiFi, IR and LRF off)	Up to 6 hours continuous running (@25°C, WiFi, IR and LRF off)
Power	5 VDC/2 A, USB Type-C interface Supports external power supply	5 VDC/2 A, USB Type-C interface Supports external power supply	5 VDC/2 A, USB Type-C interface Supports external power supply

	<b>ObservIR LRF 25-256</b>	<b>ObservIR LRF 35-384</b>	<b>ObservIR LRF 35-640</b>
<b>Working Temperature</b>	-20°C to 55°C (-4°F to 131°F)	-20°C to 55°C (-4°F to 131°F)	-20°C to 55°C (-4°F to 131°F)
<b>Protection Level</b>	IP67 (Waterproof)	IP67 (Waterproof)	IP67 (Waterproof)
<b>Dimensions</b>	221×142×71 mm (8.7×5.6×2.8 in)	221×142×71 mm (8.7×5.6×2.8 in)	221×142×71 mm (8.7×5.6×2.8 in)
<b>Weight (w/o batteries)</b>	0.89 kg (1.96 lb)	0.92 kg (2.03 lb)	0.92 kg (2.03 lb)

*\*All data is subject to change without notice.*



## **AGM Global Vision, LLC**

### **MAIN OFFICE**

173 West Main Street

PO Box 962

Springerville, AZ 85938

USA

Tel. +1.928.333.4300

[info@agmglobalvision.com](mailto:info@agmglobalvision.com)

[www.agmglobalvision.com](http://www.agmglobalvision.com)

### **EUROPEAN OFFICE**

#6 Andrey Lyapchev Blvd

Sofia, P.C. 1756

Bulgaria

Tel. +35.988.560.0326

[info@agmglobalvision.eu](mailto:info@agmglobalvision.eu)

[www.agmglobalvision.eu](http://www.agmglobalvision.eu)

### **DOWNLOAD AGM CONNECT APP:**



Google Play Store



Apple App Store

[AGMglobalvision.com](http://AGMglobalvision.com)