

AC INFINITY

# CONTROLLER 69

USER MANUAL

## WELCOME

Thank you for choosing AC Infinity. We are committed to product quality and friendly customer service. If you have any questions or suggestions, please don't hesitate to [contact](#) us. Visit [www.acinfinity.com](http://www.acinfinity.com) and click contact for our contact information.

### EMAIL

[support@acinfinity.com](mailto:support@acinfinity.com)

### WEB

[www.acinfinity.com](http://www.acinfinity.com)

### LOCATION

Los Angeles, CA

## MANUAL CODE CTR692111X1

### PRODUCT

CONTROLLER 69

### MODEL

CTR69A

### UPC-A

819137022652

## FAN COMPATIBILITY

This controller is natively compatible with AC Infinity devices with UIST™ connectors. Older model inline fans with EC motors may be used with this controller using a Molex adapter. An EC-motor fan will have two cords coming out of its motor box for the power and the controller. Note that certain models that previously used DC-motors now contain EC-motors in updated builds.

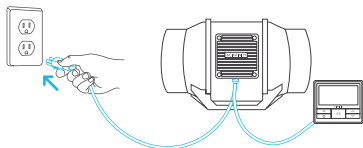

**EC Motor - Compatible**

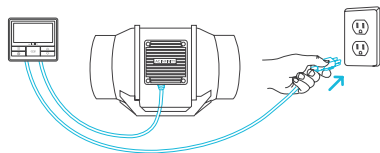

**AC or DC Motor - NOT Compatible**

Please visit [www.acinfinity.com](http://www.acinfinity.com) to check for the latest models compatible with this controller.

# MANUAL INDEX

Compatibility .....	Page 4
Manual Index .....	Page 5
Product Warning .....	Page 6
Key Features .....	Page 7
Product Contents .....	Page 8
Powering and Setup .....	Page 9
Controller Mounting .....	Page 11
Universal Infinity System .....	Page 14
UIS Compatibility .....	Page 15
Add More Devices .....	Page 16
Programming .....	Page 18
Maximum and Minimum Settings .....	Page 33
Other Settings .....	Page 34
Download the App .....	Page 35
Add a Device .....	Page 36
FAQ.....	Page 39
Other AC Infinity Products .....	Page 42
Warranty .....	Page 43

# PRODUCT WARNING



TO REDUCE THE RISK OF FIRE, ELECTRIC SHOCK, OR INJURY TO PERSONS,  
OBSERVE THE FOLLOWING:

1. Ensure your power source conforms to the electrical requirements of this product.
2. Check your local code restrictions for additional safety measures that may be needed for a proper code compliant installation.
3. Read all instructions before installing and using this product.
4. If you are unfamiliar or have doubts about performing this product's installation, seek the services of a qualified, trained, and licensed professional. Inappropriate installation will void this product's warranty.
5. This product must not be used in potentially hazardous locations such as flammable, explosive, chemical-laden or wet atmospheres.
6. Ducted products must always be vented to outdoor areas.
7. Do not cover power cords with rugs or other fabric materials.
8. This product pairs with those that has rotating parts. Safety precautions should be exercised during the installation, operation, and maintenance of this product.
9. Do not insert or allow fingers or foreign objects to enter any ventilation or exhaust openings as it may cause electric shock, fire, or damage to this product. Do not block or tamper with this product in any manner while it is in operation.
10. Do not depend on the on/off programming as the sole means of shutting power from this product. Unplug the power cord before installing, servicing, or moving this product.
11. Do not operate this product while its cord is damaged, or if it malfunctions, has been dropped, or is damaged in any manner.

# KEY FEATURES

## SMART CONTROLLER

Features automation controls that activate your devices based on climate conditions, timers, and schedules.

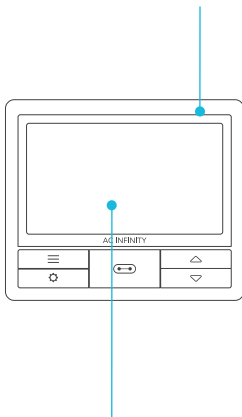

## ACTIVE MONITORING

LCD display shows key data like temperature, humidity, device levels, trends, time, countdowns, and more.

## VERSATILE PLACEMENT

Mount the controller on a steel surface using the rear magnet or open the kickstand to sit it tilted on your desktop.

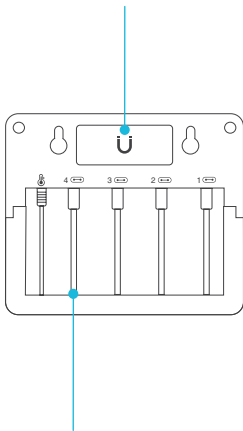

## UIS CONNECTIVITY

Connect up to four devices to simultaneously set programming for all devices or independently for each device.

## APP-CONTROLLED

Bluetooth-enabled to connect with the AC Infinity app for access to smart automations, climate data, and history logs.

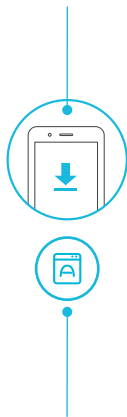

## ADVANCE SETTINGS

Additional setting options include Fahrenheit/Celsius toggling, clock, calibrations, and custom transitions.

# PRODUCT CONTENTS



SMART  
CONTROLLER  
(x1)

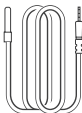

SENSOR  
PROBE  
(x1)

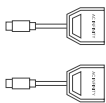

UIS M - 4PIN F  
ADAPTER  
(x2)



CONTROLLER  
PLATE BOLTS  
(x2)



WOOD SCREWS  
(WALL HANG)  
(x2)

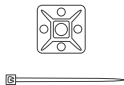

WIRE  
TIE  
(x1)

# POWERING AND SETUP

## STEP 1

Plug your device's UIS connector into one of the controller's ports.

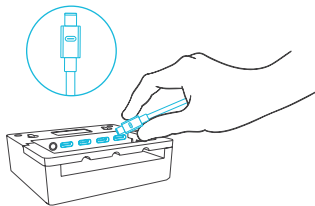

---

## STEP 2

Plug the sensor probe into the controller's 3.5mm jack. Set the probe near your plants in your grow tent for the most accurate reading.

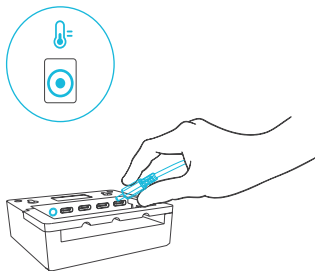



# POWERING AND SETUP

## STEP 3

Plug your device's power cord into an AC power outlet to power it and the controller.

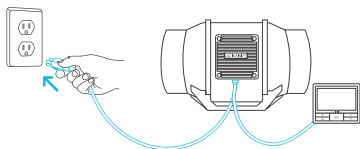

---

## STEP 4

You may use the included tie mounts, wood screws, and zip ties to cable manage the cords.

Secure the tie mounts onto a surface using the wood screws. Loop the zip ties around the cords into the tie mounts.

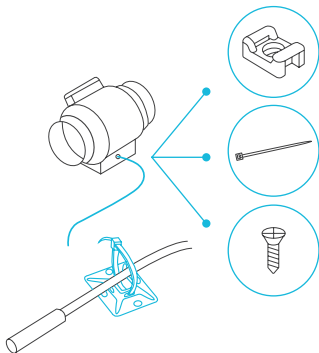

# CONTROLLER MOUNTING

## STEP 1 — WALL MOUNTING

Locate a spot free of obstruction and secure the anchors into your wall. Twist the wood screws into the anchors.

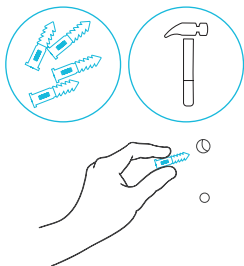

---

## STEP 2 — WALL MOUNTING

Hang the controller by the screws using the holes on the backside.

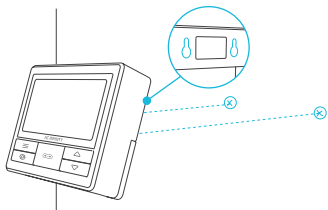

# CONTROLLER MOUNTING

## MAGNET MOUNTING

You may also mount the controller onto a steel surface using the magnet located behind the label.

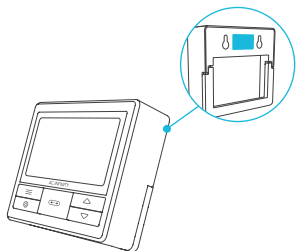

---

## PLATE MOUNTING\*

Screw the bolts into the slit at the upper half of the plate.

Hang the controller by the bolts using the holes on the backside.

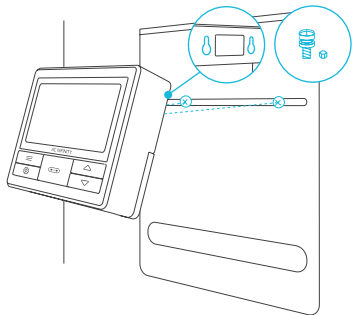

\*Controller plate not included

# CONTROLLER MOUNTING

## T-SERIES

### CORD ARRANGEMENT

Cords may be routed into or outside of the kickstand grooves, and through a cut hole behind the controller.

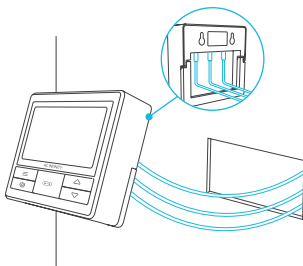

---

### KICKSTANDING

Open the stand behind the controller to set it tilted on your desktop.

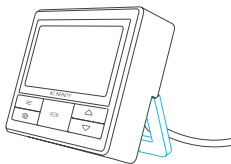

# UNIVERSAL INFINITY SYSTEM

The Universal Infinity System™ enables you to connect a single central controller with several grow devices simultaneously. By creating this fully integrated system, you can power and program all your devices together or separately for optimized grow tent management.

Use select smart controllers to set triggers that will activate your devices based on your grow tent's temperature and humidity. Create independent timers and schedules for customized activation in your desired timeframe.

Your grow system can be regulated using your controller hub or remotely on the AC Infinity app (paired with compatible controllers), where you will have access to automation programming and climate data.

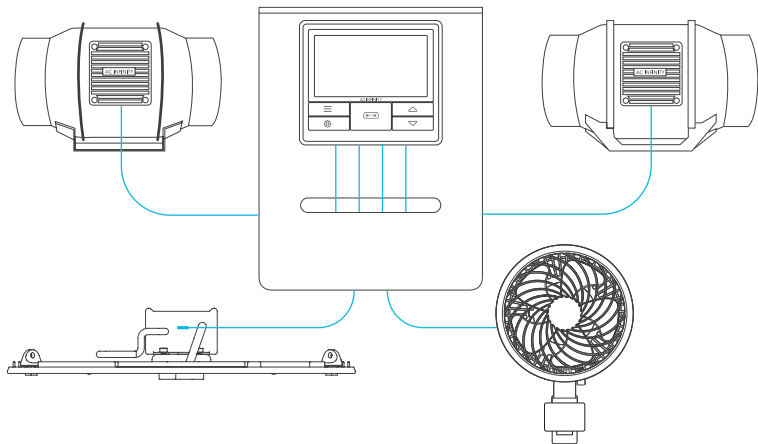

**Grow devices will be sold separately and may still be in development at the time of your purchase of this product.**

# UIS COMPATIBILITY

## MOLEX ADAPTER

Use the included Molex adapter to plug inline fans with 4-pin Molex connectors into this controller. Plug your fan's Molex connector into the adapter. Then plug the adapter into the controller.

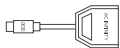

UIS M - 4PIN F  
ADAPTER

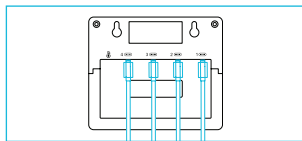

## EXTENSION CABLE

Use male-to-male UIS extension cords to connect devices with female UIS ports at an extended range from your controller.

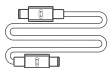

UIS M - M  
CORD

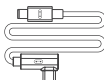

UIS M - M  
CLIP FAN CORD

## EXPANSION DONGLE

The expansion dongle will allow you to connect 2 or 4 devices with a single port and can support additional dongles to create more expansion ports (up to 64 units supported with the use of 20 dongles\*). Intended for exclusive use with AC Infinity controllers built with UIS ports.

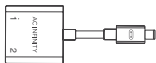

UIS M - M  
2 PORT DONGLE

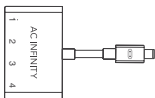

UIS M - M  
4 PORT DONGLE

\*UIS extension cord and dongle sold separately

# ADDING MORE DEVICES

The CONTROLLER 69 is built with four ports that enable you to power and control multiple devices at the same time. See image below for a sample configuration.

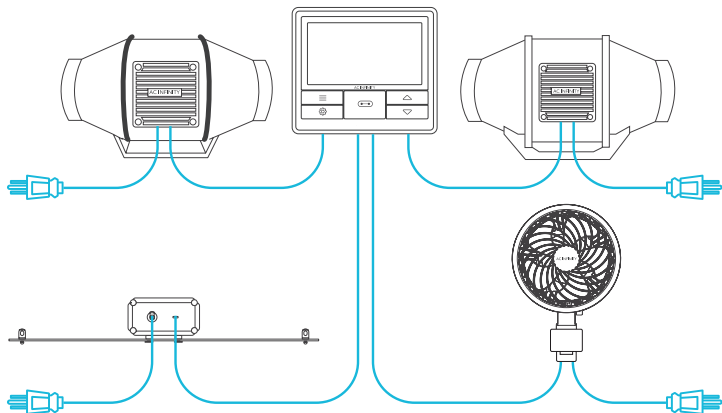

# ADDING MORE DEVICES

## USING THE DONGLE

Each controller port can support mix-and-matched devices regardless of their size.

When using a 2-port or 4-port dongle, plug your first device into Port 1 for the controller to recognize as the primary device.

All other devices plugged into the dongle will follow programming intended for the device plugged into Port 1.

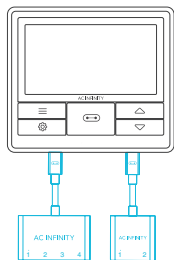

---

## EXTENDING THE CHAIN

When plugging additional dongles into Port 1, all devices plugged into this chain must be of the same type (ex. grow lights of any size) regardless of the length of the dongle chain.

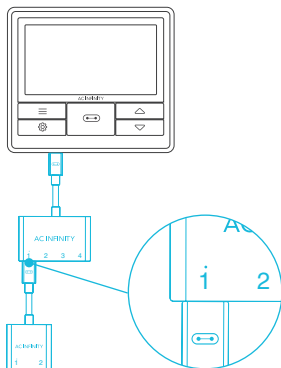



# PROGRAMMING

## 1. PORT BUTTON

Cycles through up to four connected devices. Each device is programmed independently, or together when navigating to ALL.

## 4. UP/DOWN BUTTONS

Adjusts the value of your current mode. The up button increases and down button decreases the setting. Hold both to reset values to OFF or 0.

## 6. PROBE TEMP.

Displays the current temperature that the probe is detecting. Shows "--" if no probe is plugged in. Includes a trend indicator that signals a rise, steady, or fall in temperature within the last hour.

## 8. CONTROLLER MODE

Displays the controller's current mode. Pressing the mode button cycles through the available modes.

## 11. CURRENT LEVEL

Displays the connected devices' current setting. Includes a trend indicator that signals if the setting is currently rising, falling, or holding steady.

## 2. MODE BUTTON

Cycles through the controller's modes: OFF, ON, AUTO (4 triggers), TIMER to ON, TIMER to OFF, CYCLE (ON and OFF), and SCHEDULE (ON and OFF).

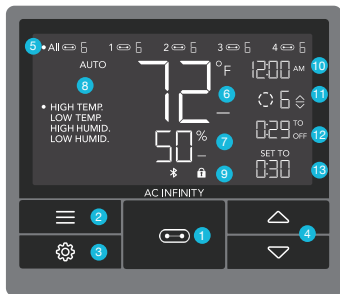

## 9. ALERT ICONS

Displays alerts and statuses of the controller, including the controller lock, CLIMATE alert, and TIMER alert.

## 12. COUNTDOWN

Displays the countdown of the TIMER TO ON, TIMER TO OFF, CYCLE, or SCHEDULE mode activates or deactivates the devices. TO ON shows the amount of time left before the devices turn on. TO OFF shows the amount of time left before the device turn off.

## 3. SETTING BUTTON

Cycles through the controller's settings: DISPLAY, CLOCK, °F/°C, CALIB. T°/H%, and TRANS. T°/H%.

## 5. PORTS

Displays all connected devices as well as their current level. Digits are displayed by the UIS symbol when a device is plugged into its corresponding port.

## 7. PROBE HUMIDITY

Displays the current humidity that the probe is measuring. Shows "--" if no probe is plugged in. Includes a trend indicator that signals a rise, steady, or fall in humidity within the last hour.

## 10. CURRENT TIME

Displays the current time. The internal battery sustains the clock so it does not default to 00:00 if power is cut off.

## 13. USER SETTING

Displays the value of your current mode. Use the up or down buttons to adjust the value.

# PROGRAMMING

## PORTS

Pressing the port button will cycle through the controller's available ports: ALL, 1, 2, 3, and 4. Dot indicates the current device. No digit is displayed if a device is not plugged into the corresponding port.

## ALL PORTS

Navigate to the ALL port to set simultaneous programming for all connected devices.

Programming set in this port mode applies to all connected devices, but will not be active if you navigate to other ports. Re-entering the ALL port will resume its programming.

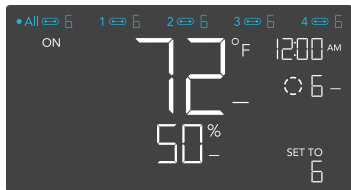

---

## INDIVIDUAL PORT

Navigate to a numbered port with a connected device to set individual programming.

Programming will run in the background even while you navigate to other numbered ports.



# PROGRAMMING

## CONTROLLER MODES

Pressing the mode button will cycle through the controller's available programming modes: OFF, ON, AUTO (4 triggers), TIMER TO ON, TIMER TO OFF, CYCLE (On and Off), and SCHEDULE (On and Off).

### OFF MODE (ALSO SETS MINIMUM LEVEL)

Your devices will not run while in this mode.

The level set while in this mode establishes the minimum level in other modes. When the devices are triggered to turn OFF in all other modes, they will instead run at the level set here. Set the level to zero if you want the device to turn off when triggered OFF.



### ON MODE (ALSO SETS MAXIMUM LEVEL)

Your devices will actively run at the level set here, regardless of the probe's reading. The ON mode also serves as the maximum level setting the other modes will run in. Don't set the level to zero or the device will turn off when it's triggered ON.



# PROGRAMMING

## AUTO MODE (HIGH TEMPERATURE TRIGGER)

Pressing the up or down button sets the high temperature trigger. The devices will activate if the probe's reading meets or exceeds this threshold.

Once triggered, the devices will gradually ramp up to the level set in ON mode. If the probe's reading falls below this trigger point, the devices will gradually slow down to a stop or at the level set in OFF mode.

You may set this trigger below the low temperature trigger to create a specific range in which the devices are active.

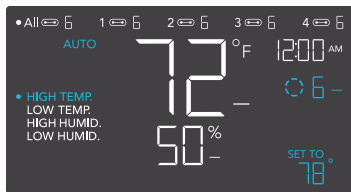

Any of the four trigger points can activate while you are in AUTO Mode, even if you are viewing another trigger point. Please set a trigger point to OFF if not in use, by holding down the up and down button.

If there is a level set in OFF Mode other than zero, the devices will run at that level when triggered to turn off.

## AUTO MODE (LOW TEMPERATURE TRIGGER)

Pressing the up or down button sets the low temperature trigger. The devices will activate if the probe's reading meets or falls below this threshold.

Once triggered, the devices will gradually ramp up to the level set in ON mode. If the probe's reading rises above this trigger point, the devices will gradually slow down to a stop or at the level set in OFF mode.

You may set this trigger above the high temperature trigger to create a specific range in which the devices are active.



Any of the four trigger points can activate while you are in AUTO Mode, even if you are viewing another trigger point. Please set a trigger point to OFF if not in use, by holding down the up and down button.

If there is a level set in OFF Mode other than zero, the devices will run at that level when triggered to turn off.

# PROGRAMMING

## AUTO MODE (HIGH HUMIDITY TRIGGER)

Pressing the up or down button sets the high humidity trigger. The devices will activate if the probe's reading meets or exceeds this threshold.

Once triggered, the devices will gradually ramp up to the level set in ON mode. If the probe's reading falls below this trigger point, the devices will gradually slow down to a stop or at the level set in OFF mode.

You may set this trigger below the low humidity trigger to create a specific range in which the devices are active.

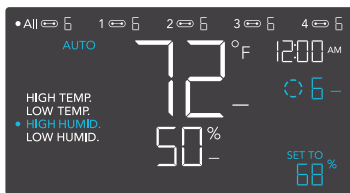

Any of the four trigger points can activate while you are in AUTO Mode, even if you are viewing another trigger point. Please set a trigger point to OFF if not in use, by holding down the up and down button.

If there is a level set in OFF Mode other than zero, the devices will run at that level when triggered to turn off.

## AUTO MODE (LOW HUMIDITY TRIGGER)

Pressing the up or down button sets the low humidity trigger. The devices will activate if the probe's reading meets or falls below this threshold.

Once triggered, the devices will gradually ramp up to the level set in ON mode. If the probe's reading rises above this trigger point, the devices will gradually slow down to a stop or at the level set in OFF Mode.

You may set this trigger above the high humidity trigger to create a range in which the devices are active.

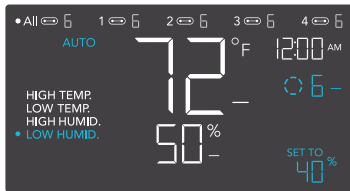

Any of the four trigger points can activate while you are in AUTO Mode, even if you are viewing another trigger point. Please set a trigger point to OFF if not in use, by holding down the up and down button.

If there is a level set in OFF Mode other than zero, the devices will run at that level when triggered to turn off.

# PROGRAMMING

## TIMER TO ON MODE

Pressing the up or down button sets a countdown time. Once the timer ends, the devices will trigger to run at the level set in ON Mode. If there is a level set in OFF Mode, the devices will run at that level during the countdown.

The countdown will begin if no buttons are pressed for 5 seconds. The time left on the countdown is displayed below the current level. Leaving the timer mode while the countdown is running will pause it until you return to this mode.



If there is a level set in OFF Mode other than zero, the devices will run at that level when triggered to turn off.

## TIMER TO OFF MODE

Pressing the up or down button sets a countdown time. The devices will run at the level set in ON Mode until the countdown ends. If there is a level set in OFF Mode, the devices will run at that level after the end of the countdown.

The countdown will begin if no buttons are pressed for 5 seconds. The time left on the countdown is displayed below the current level. Leaving the timer mode while the countdown is running will pause it until you return to this mode.



If there is a level set in OFF Mode other than zero, the devices will run at that level when triggered to turn off.

# PROGRAMMING

## CYCLE MODE (ON AND OFF)

Set an on duration and an off duration for the devices to cycle through continuously. Press the up or down button to first set a duration for the devices to activate. Then press the mode button again and set a duration for the devices to deactivate.

When the devices are activated, they will run at the level set in ON Mode. When the devices are deactivated, they will run at the level set in OFF Mode.

The countdown will begin if no buttons are pressed for 5 seconds. The time left on the countdown before the next ON or OFF phase is displayed below the current level. Leaving the cycle mode while the countdown is running will pause it until you return to this mode.

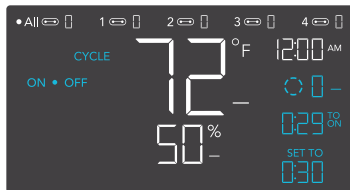
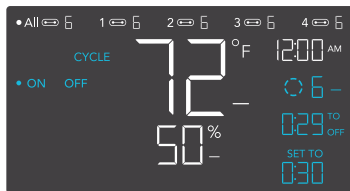

If there is a level set in OFF Mode other than zero, the devices will run at that level when triggered to turn off.

# PROGRAMMING

## SCHEDULE MODE (ON AND OFF)

Sets an on clock-time and an off clock-time schedule for the devices to follow daily. Press the up or down button to first set up an on clock-time to trigger ON mode, then press the mode button to set an off clock-time to trigger OFF mode. Please be sure to set the current clock time under settings.

When the devices are triggered to activate, they will run at the level set in ON Mode. When the devices are triggered to deactivate, they will run at the level set in OFF Mode.

The countdown will begin if no buttons are pressed for 5 seconds. The time left on the countdown before the next on or off phase is displayed below the current level. The devices will not follow this schedule if you leave this mode. If you re-enter the Schedule Mode, they will continue to follow the latest schedule you have set.

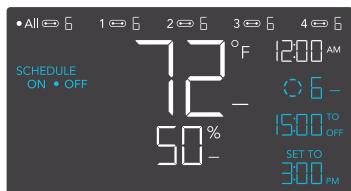
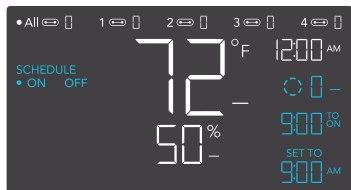

If there is a level set in OFF Mode other than zero, the devices will run at that level when triggered to turn off.



# PROGRAMMING

## CONTROLLER SETTINGS

Pressing the setting button will cycle through the controller's available settings: DISPLAY, °F/°C, CLOCK, CALIB. T°, CALIB. H%, TRANS. T°, and TRANS. H%.

### DISPLAY SETTING

Adjusts the display brightness and auto-dimming. Press the up or down button to cycle through levels 1, 2, 3, A2 and A3; 3 being the highest brightness setting, while 1 is the lowest. In settings 1, 2 and 3, the display will stay at that brightness level and will not automatically dim the display.

A2 and A3 will set the brightness level at 2 and 3, respectively, and will dim down the brightness level 1 when the controller is not being used after 15 seconds.



### TOGGLING THE DISPLAY

Lock the controller by holding the setting button.

Press the setting button to turn the display off. Pressing the setting button again will turn the display back on.

Programs will still run in the background while the LCD screen is off.

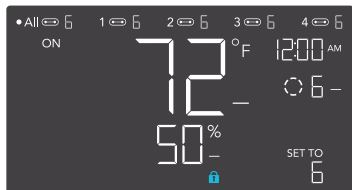

# PROGRAMMING

## °F/°C SETTING

Changes the displayed units to Fahrenheit or Celsius. Press the up or down button to cycle through F and C. All displayed units will automatically convert when adjusting this setting.

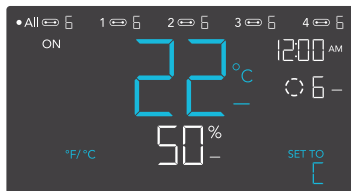

---

## CLOCK SETTING

Adjusts the current clock time. Press the up or down button to increase or decrease the time. Once you cycle through 12:00 each time, the units will automatically change to AM or PM. The clock time is located at the top right corner of the display.



# PROGRAMMING

## CALIBRATION TEMPERATURE SETTING

Adjusts the temperature reading the sensor probe is measuring. Press the up or down button to increase or decrease the data figure in 2°F (or 1°C) increments. The calibration cycle ranges from -20°F to 20°F (or -10°C to 10°C) and will be applied to the sensor probe's measurements.

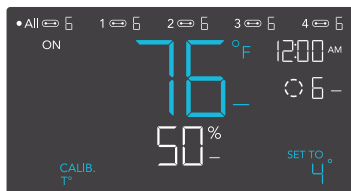

---

## CALIBRATION HUMIDITY SETTING

Adjusts the relative humidity reading the sensor probe is measuring. Press the up or down button to increase or decrease the data figure in 1% increments. The calibration cycle ranges from -10% to 10% and will be applied to the sensor probe's measurements.

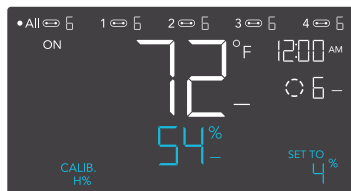

# PROGRAMMING

## TRANSITION TEMPERATURE SETTING

Customizes how the device will ramp up in levels when triggered ON by temperature in AUTO MODE. Set a transition threshold to determine how much the probe temperature would need to surpass your trigger point for the device to increase in level by one. The higher the transition threshold figure is set to, the more the probe temperature would need to surpass your set temperature trigger for the level to increase. The lower the figure, the less the probe temperature would need to surpass your set temperature trigger for the level to increase. If the figure is set to zero, it will jump to your maximum set level without ramping when triggered ON.

Press the up or down button to cycle through 0°F to 8°F (0°C to 4°C) and set a transition threshold. The level will be set one level above the OFF Mode level when the sensor temperature first meets or exceeds the high temperature trigger. For every transition threshold crossed, the level will ramp up by one level, up until it reaches the level set in ON Mode.

In this example, your high temperature trigger is set at 80°F, the OFF Mode level is 0, and the ON Mode level is 6. If the transition threshold is set to 0°F, then the devices will trigger to run at level 6 when the sensor temperature meets or exceeds 80°F. However, if the transition threshold is set to 2°F, then the devices will trigger to run at level 1 when it meets or exceeds 80°F. It will then step up to level 2 when meeting or exceeding 82°F, level 3 at 84°F, level 4 at 86°F, and level 5 at 88°F. From 90°F on, it will run at level 6, the level set in ON Mode.

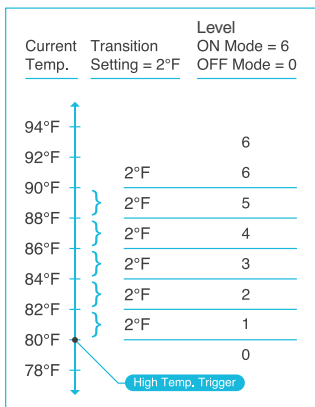
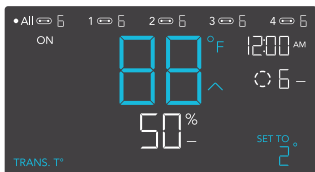

# PROGRAMMING

## TRANSITION HUMIDITY SETTING

Customizes how the device will ramp up in levels when triggered ON by humidity in AUTO MODE. Set a transition threshold to determine how much the probe humidity would need to surpass your trigger point for the device to increase in level by one. The higher the transition threshold figure is set to, the more the probe humidity would need to surpass your set humidity trigger for the level to increase. The lower the figure, the less the probe humidity would need to surpass your set humidity trigger for the level to increase. If the figure is set to zero, it will jump to your maximum set level without ramping when triggered ON.

Press the up or down button to cycle through 0% to 8% to set a transition threshold. The level will be set one level above the OFF Mode level when the sensor humidity first meets or exceeds the high humidity trigger. For every transition threshold crossed, the level will ramp up by one level, up until it reaches the level set in ON Mode.

In this example, your high humidity trigger is set at 67%, the OFF Mode level is 2, and the ON Mode level is 7. If the transition threshold is set to 0%, then the devices will trigger to run at level 7 when the sensor humidity meets or exceeds 67%. However, if the transition threshold is set to 5%, then the fan will trigger to run at level 3 when it meets or exceeds 67%. It will then step up to level 4 when meeting or exceeding 72%, level 5 at 77%, and level 6 at 82%. From 87% on, it will run at level 7, the level set in ON Mode.

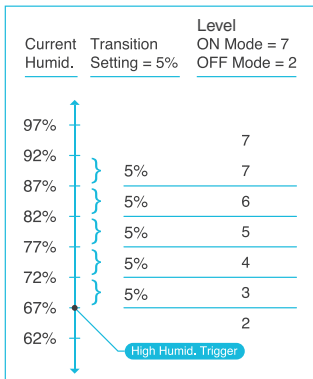
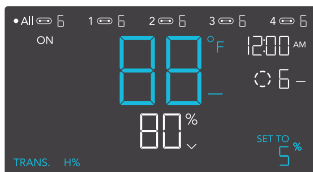

# PROGRAMMING

## ALERT ICONS

The alert icons are displayed at the top of the screen. Icons may flash when the controller signals an alert to notify you of any triggered function or alarm.

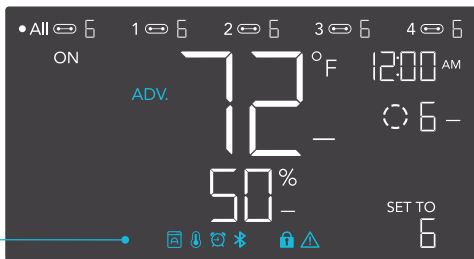

### ADVANCE PROGRAMMING

Displays when an advance program set in the app is active. "ADV." will appear and override the controller if an automation program is in use.



### AUTO MODE ALERT

Flashes whenever any of the auto mode triggers (high temperature, low temperature, high humidity, or low humidity) activate your devices.



### TIMER ALERT

Flashes when a countdown has completed for TIMER TO ON, TIMER TO OFF, CYCLE, or SCHEDULE Mode.

# PROGRAMMING

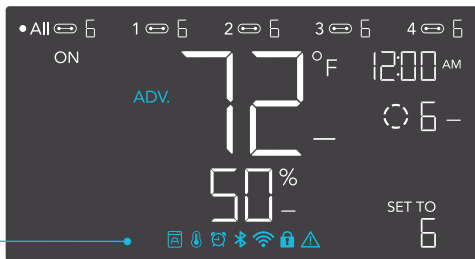

## BLUETOOTH

Appears when the physical controller is connected to the app via Bluetooth.



## DISPLAY LOCK ALERT

Displays when you lock the controller. The icon will flash and beep if you attempt to adjust the controller while it is still locked.



## TEMPERATURE/ HUMIDITY ALARM

Flashes and beeps with alarm if the temperature/ humidity meet the trigger point set in the app.

# MAX AND MIN SETTINGS

## MAXIMUM LEVEL

You can determine what level the device will run at when its triggered ON. This can be set in ON MODE. The level you leave that mode in will be used as the level the device will run at when triggered ON. This includes AUTO MODE, CYCLE MODE, TIMER TO ON MODE, TIMER TO OFF MODE, and SCHEDULE MODE. Do not set the figure in ON MODE to zero or the device will turn off when it's triggered ON in all modes.



ON MODE  
SET TO  
6\*  
MAX LEVEL

\*Example shown

## MINIMUM LEVEL

You can set a minimum level for the device to continuously run at until it's triggered ON. This can be set in OFF MODE. The level you leave that mode in will be used as the minimum level for all other modes such as AUTO MODE, CYCLE MODE, TIMER TO ON MODE, TIMER TO OFF MODE, and SCHEDULE MODE. They will run at the level set here even when they are triggered to be OFF. They will continuously run until they are triggered to be ON, at which they will run at the level you had set in ON MODE. If you want the device to actually turn off when it's triggered to be OFF, please set the figure in OFF MODE to zero.



OFF MODE  
SET TO  
3\*  
MIN LEVEL

\*Example shown



# OTHER SETTINGS

## FACTORY RESET

Holding the mode, up, and down buttons together for 5 seconds will reset your controller and restore factory settings. This clears all user parameters in each controller mode and setting.



---

## CONTROLLER LOCK

Holding the setting button will lock the controller in your current mode. While your controller is locked, no parameters may be adjusted, nor will you be able to switch modes. Holding the setting button again will unlock the controller.



---

## HIDE SCREEN

Lock the controller so no settings can be adjusted. See above. Then press the setting button to turn the display off. Pressing it again will turn the display back on. Programs will still run in the background while the LCD screen is off.



---

## JUMP TO OFF MODE

Holding the mode button for 3 seconds while in any mode or setting will automatically jump to OFF Mode. This function is disabled if the controller is locked.



---

## RESET TO OFF/DEFAULT

Holding the up and down buttons together for 2 seconds will reset the value of your current mode or controller setting to OFF/Default. Pressing either the up or down button will return to the previous value.



---

## AUTO INCREASING OR DECREASING

Holding the up or down button will increase or decrease the user setting automatically until you release them.



# DOWNLOAD THE APP

## THE AC INFINITY APP

The AC Infinity app enables you to connect with the next generation of our intelligent controllers, giving you access to advance programs and environmental data.

1

Download the AC Infinity app from the App Store or Play Store by searching “AC Infinity”.



2

Open the AC Infinity app and follow the instructions on page 36-38 to pair your controller with the app.



---

## QUICK TIP FOR EASY ACCESS

Open the smart phone camera and scan the QR code below to download the AC Infinity app. Please visit our website at [www.acinfinity.com](http://www.acinfinity.com) for more information on the AC Infinity app.



Please note: The AC Infinity App's appearance and features are subject to change, and please refer to our website/QR for the latest instructions.

# ADD A DEVICE

## SETUP AND PAIRING

Power your device on before pairing your device with the app. Refer to pages 9-10 for more information regarding controller setup.

1

Tap on the "+" tab to add your smart device.

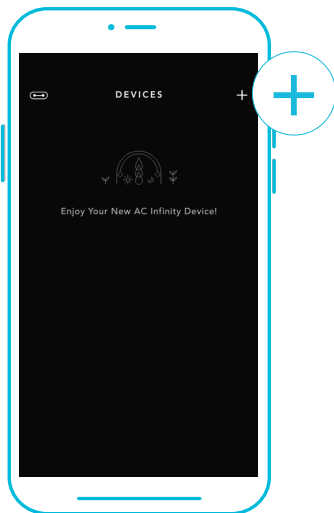

2

To launch the app, tap on the "Smart Controllers" tab to begin pairing.

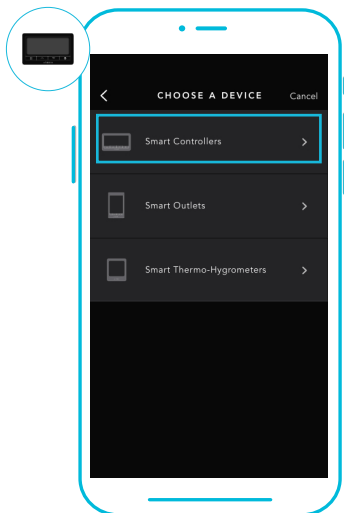

Please note: Bluetooth must be enabled on your mobile device before starting the pairing process.

# ADD A DEVICE

3

Select CONTROLLER 69 to begin pairing.

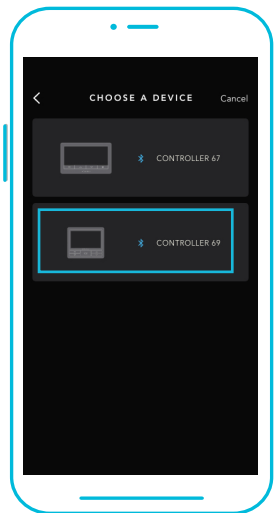

4

Hold the port button for 5 seconds to activate Bluetooth. Wait for the Bluetooth icon to start flashing on your controller's screen.



# ADD A DEVICE

5

Tap DONE button to complete the pairing process.

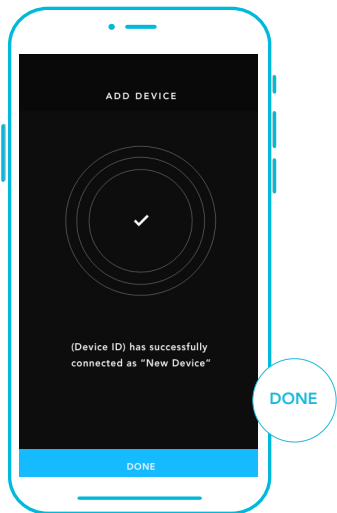

6

Your controller will appear in your smart device with a unique ID.

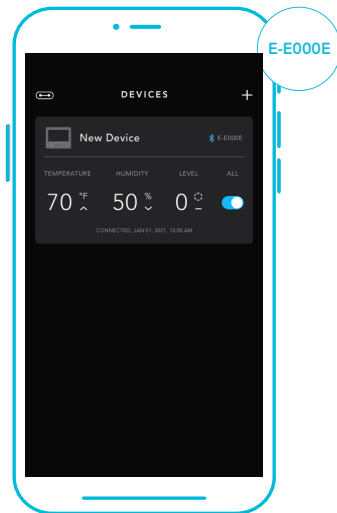

Please note: When pairing the app around multiple controllers, move your mobile device closer to your desired controller.

# CONTROLLER 69 FAQ

**Q:** What devices are compatible with the CONTROLLER 69?

**A:** All AC Infinity devices that contain a UIS connector are compatible. If your AC Infinity device has a 4-pin Molex connector and an EC-Motor, it may still be compatible with the use of an UIS adapter to convert its connector to fit with the controller.

---

**Q:** What does “level” refer to in the controller and app?

**A:** The level represents the intensity the device is running at. This is represented by a digit 0 to 10. Zero means the device is off, and 10 represents its running at its maximum. For fan devices, the level would be referring to its speed. For light devices, the level would be referring to its brightness. Note that on and off devices do not have a level setting.

---

**Q:** Why is my device is not turning off when the programming is triggering it to be off?

**A:** The figure set in OFF MODE determines the device's level when it's triggered to be OFF in all other modes. Set that figure to zero if you want the device to turn off when triggered OFF. If this is occurring in AUTO MODE, please check your high and low triggers point which can all activate concurrently. Turn off any trigger points that are not in use. If you are using the App, please check if you have any ADVANCE programming which can override any control programming.

---

**Q:** Why does my device not run or run at a low level when the programming is triggering it to be on?

**A:** The figure set in ON MODE determines the device's level when it's triggered to be ON in all other modes. Make sure that figure is not set to zero or the device will not run when it's triggered to be ON. If this is occurring in AUTO MODE, please check your high and low triggers point which can all activate concurrently. Turn off any trigger points that are not in use. If you are using the App, please check if you have any ADVANCE programming which can override any control programming.

# CONTROLLER 69 FAQ

**Q:** How do I stop my device from turning on and off too quickly in AUTO MODE?

**A:** The figure set in the TRANSITION under SETTINGS will determine how the device ramps up in levels when triggered to run in AUTO MODE. Set a transition threshold X. For every multiple of X that has surpassed your trigger point, the device will increase by one level. The lower the transition threshold is set to, the easier it will be for the device to ramp up in levels. If set to zero, the device will jump to the max set speed without ramping when triggered. This may cause the device to turn on and off quickly if the climate fluctuates back and forth. Increase the transition threshold number to help smooth out the transitions. Please also check your high and low triggers point which can all activate concurrently. Turn off any trigger points that are not in use.

---

**Q:** How do I set a minimum speed for constant ventilation, that would ramp up when triggered?

**A:** If a fan device is connected, the figure set in OFF MODE determines the fan speed when it's triggered to be OFF in all other modes. When the fan isn't triggered ON, it will be considered OFF and so it will run at that minimum speed continuously. Once triggered ON, it will change its speed to the figure set under ON MODE.

---

**Q:** Where is the best place to position the sensor probe?

**A:** Place the sensor probe as close as possible to the hottest or most humid spot in your space.

---

**Q:** Do I need to remove the plastic cap from the probe?

**A:** Yes. You will need to remove the plastic cap so the probe can accurately read climate conditions.

---

**Q:** Can I connect different sized fans to the same controller?

**A:** Please refer to page 16-17 for details on adding more fan units.

# CONTROLLER 69 FAQ

**Q:** Will I be able to use this controller with my own fan?

**A:** The CONTROLLER 69 is only compatible with AC Infinity fans that use EC-motors.

---

**Q:** Does the controller retain its settings after power is shut off?

**A:** Yes. If the controller's power is cut off and is powered on afterwards, your settings will remain.

---

**Q:** My controller isn't pairing with the app. How do I fix this?

**A:** If the pairing process isn't successful, turn off your Bluetooth and reenable it to try again. When starting the pairing process around multiple Bluetooth controllers, move your smart device closer to the controller you wish to connect the app with.



# AC INFINITY PRODUCTS

## Advance Grow Tents

The CLOUDLAB series is a line of grow tents designed to create ideal growing conditions and facilitate indoor plant cultivation year-round. Features 2000D thick oxford canvas lined with inner diamond patterned mylar that maximizes grow light luminosity, and a reinforced frame with 150 lb. weight capacity. Includes a mounting plate to install your AC Infinity controller onto.

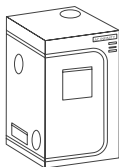

---

## Inline Duct Fans

The CLOUDLINE series is a line of duct fans designed to quietly ventilate AV rooms and closets, as well as various DIY air circulation and exhaust projects. Features a thermal controller with intelligent programming that will automatically adjust duct fan speeds in response to changing temperatures.

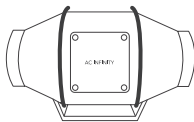

---

## Grow Lights

An indoor LED grow lamp designed to simulate outdoor daytime lighting to improve and accelerate your plant's photosynthesis. Using the latest Samsung LM301H diodes, this LED grow system efficiently produces full-spectrum lighting usable during all stages of the grow cycle.



Discover the latest innovations in cooling and ventilation at [acinfinity.com](http://acinfinity.com)

# WARRANTY

This warranty program is our commitment to you, the product sold by AC Infinity will be free from defects in manufacturing for a period of two years from the date of purchase. If a product is found to have a defect in material or workmanship, we will take the appropriate actions defined in this warranty to resolve any issues.

The warranty program applies to any order, purchase, receipt, or use of any products sold by AC Infinity or our authorized dealerships. The program covers products that have become defective, malfunctioned, or expressively if the product becomes unusable. The warranty program goes into effect on the date of purchase. The program will expire two years from the date of purchase. If your product becomes defective during that period, AC Infinity will replace your product with a new one or issue you a full refund.

The warranty program does not cover abuse or misuse. This includes physical damage, submersion of the product in water, incorrect installation such as wrong voltage input, and misuse for any reason other than intended purposes. AC Infinity is not responsible for consequential loss or incidental damages of any nature caused by the product. We will not warrant damage from normal wear such as scratches and dings.

To initiate a product warranty claim, please contact our customer service team at [support@acinfinity.com](mailto:support@acinfinity.com)



**If you have any issues with this product, contact us and we'll happily resolve your problem or issue a full refund!**

## FCC Warning

This device complies with part 15 of the FCC rules. Operation is subject to the following two conditions: (1) this device may not cause harmful interference, and (2) this device must accept any interference received, including interference that may cause undesired operation.

Changes or modifications not expressly approved by the party responsible for compliance could void the user's authority to operate the equipment.

NOTE: This equipment has been tested and found to comply with the limits for a Class B digital device, pursuant to part 15 of the FCC Rules. These limits are designed to provide reasonable protection against harmful interference in a residential installation. This equipment generates uses and can radiate radio frequency energy and, if not installed and used in accordance with the instructions, may cause harmful interference to radio communications. However, there is no guarantee that interference will not occur in a particular installation. If this equipment does cause harmful interference to radio or television reception, which can be determined by turning the equipment off and on, the user is encouraged to try to correct the interference by one or more of the following measures:

- Reorient or relocate the receiving antenna.
- Increase the separation between the equipment and receiver.
- Connect the equipment into an outlet on a circuit different from that to which the receiver is connected.
- Consult the dealer or an experienced radio/TV technician for help.

## Radiation Exposure Statement

This equipment complies with FCC radiation exposure limits set forth for an uncontrolled environment. This equipment should be installed and operated with minimum distance 20cm between the radiator and your body.

## **COPYRIGHT © 2021 AC INFINITY INC. ALL RIGHTS RESERVED**

No part of the materials including graphics or logos available in this booklet may be copied, photocopied, reproduced, translated or reduced to any electronic medium or machine readable form, in whole or in part, without specific permission from AC Infinity Inc.

[www.acinfinity.com](http://www.acinfinity.com)