

420mm

108mm

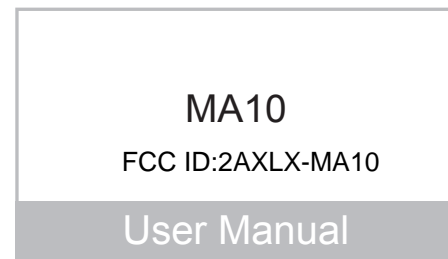

**1 Notice before using**

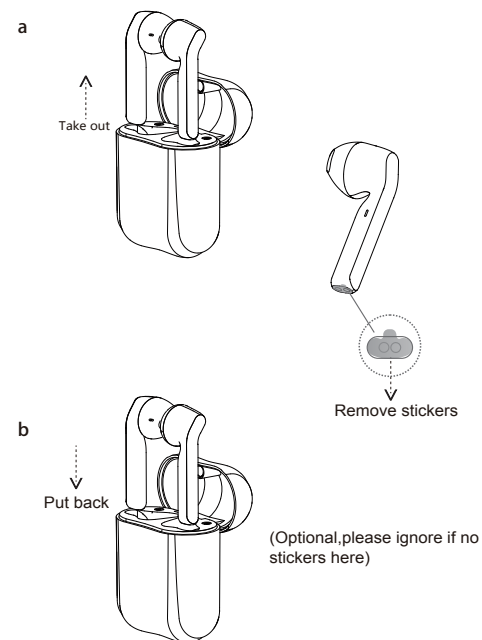

**2 Wearing method**

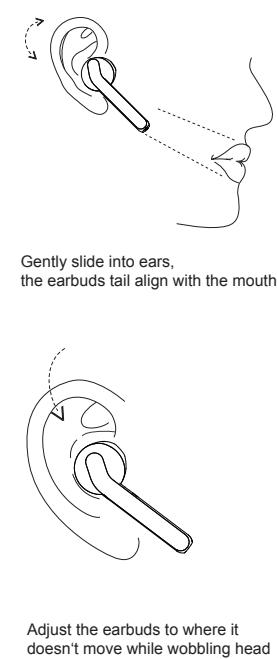

**3 Main user interface**

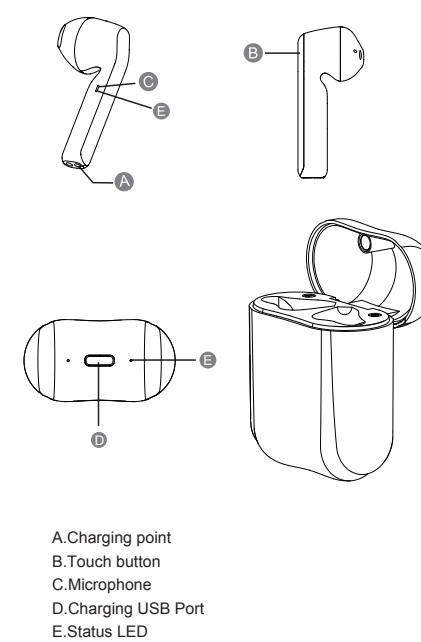

**4 Start Here**

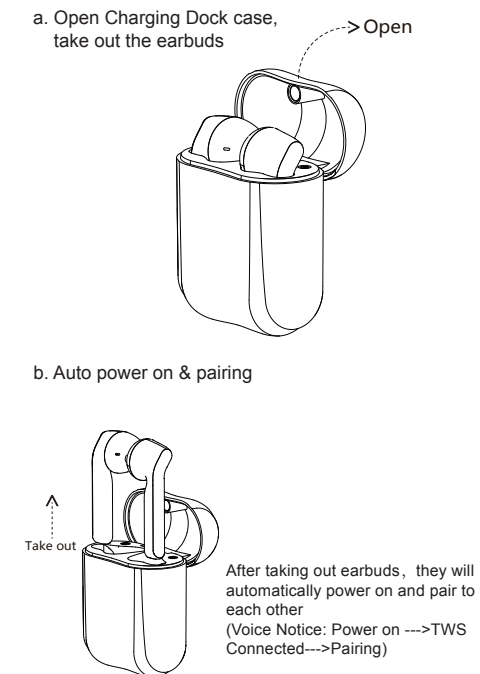

**c. Pairing with cellphone**

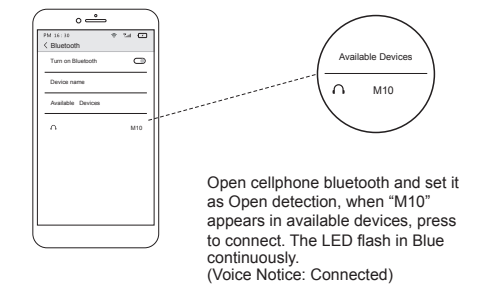

**d. Power off**

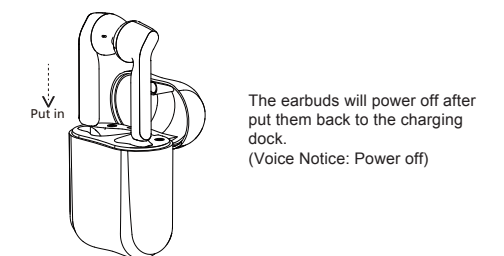

**5 Charging**

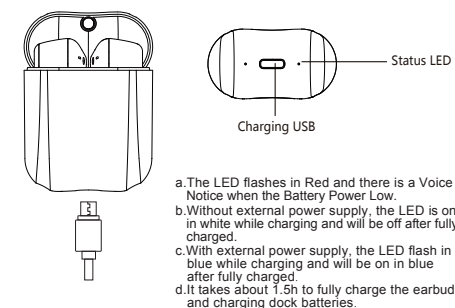

**6 More functions**

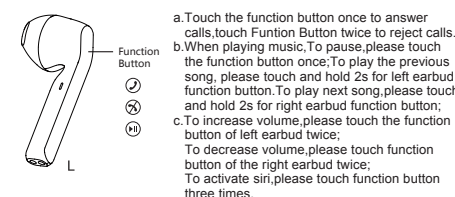

**7 Important Notice for Single Earbud using**

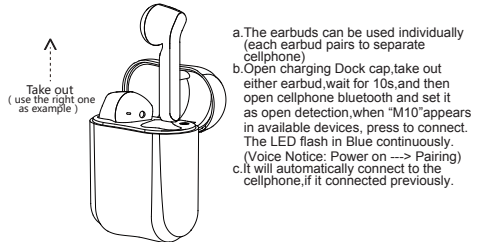

**8 Manual pairing**

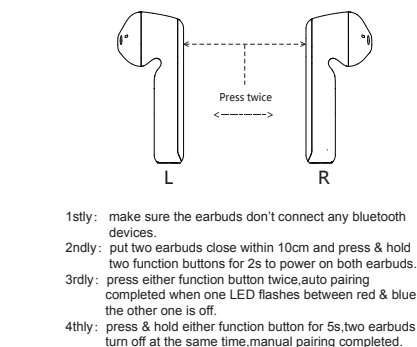

**Basic Parameter**

Product Name: MA10      Operation range: 10m  
 Charging time: 1.5 hours      Call time: 5 hours  
 Music Time: 4 hours      Charging Input: 5V---300mA  
 Battery Type: Polymer Li-Ion Battery  
 Earbud weight: 4g+4g

**Important Notice**

- Please make sure the product is fully charged before initial use.
- Please use the brand adaptor complying safety requirements to charge this product.
- If your cellphone can not find "M10", please double check if your cellphone Bluetooth is at "Equipment visible mode". After initial pairing,the earbuds will be automatically paired for repeat use. If no use for a long time, need to follow up pairing procedures to pair with the cellphone.
- If there is only one earbud has sound while in music mode, please restart the earbuds or re-pair manually.

**Questions & Answers**

Questions	Reasons	Answers
earbuds not "power on"	power run out	charge the charging dock & earbuds
earbuds pairing failure	program error caused by mal-operation	re-pair manually (pls refer to user manual VII)
charging dock LED not light on while putting in earbuds	can't detect the earbuds while they are fully charged	it will recover proper indication after using for a while
low volume	the volume setting of the earbuds & cellphone not synchronized	turn on cellphone bluetooth & synchronized its volume setting with the connected earbuds
charging dock not charging	charging protection	charge the charging Dock by external power
can't find earbuds pairing name or pairing failure with cellphone	earbuds not in pairing mode cellphone bluetooth App error	Re-"power on"the earbuds power off & re-power on cellphone

**Security warning**

- Please use the product in the temperature between 0°C-45°C. When the environment temperature is too high or low, it may cause the product malfunction.
- Please keep the product dry, do not contact water or humidity environment
- Please do not drop, throw, pull/drag the product to prevent damage.
- Please power off before clean the product.
- Please use the product at proper volume while listening music or answering call, long time at high volume usage could lead to permanent hearing loss.

- The built in battery is not dismountable, please do not replace by yourself. If it's really necessary, please ask help from authorized service center.
- Please dispose the product according to local law, can not treat it as domestic garbage.
- Without adult supervision, please keep the product out of reach of children, the swallow of small components included may cause asphyxia.

**Warranty**

- This product is covered under warranty for a period of one year from the date of purchase limited to normal use and maintenance of the machine parts, materials and functions. Problems and failures verified upon further identification, will be provided free repair and replacement parts.
- Excluding the following:
  - A. Headset is beyond the warranty period;
  - B. User does not follow the instructions. so that the headphone wire and earplug broken.
  - C. Without the authorization to dismount, repair, alteration structures;
  - D. Can't provide proof of purchase.
  - E. Man made damage.
  - F. Due to natural disasters and other force majeure (such as earthquakes, fires) product failure of damage causes;

**Warranty Card**

User's name \_\_\_\_\_  
 User's telephone# \_\_\_\_\_  
 User's Add \_\_\_\_\_  
 Date of purchase \_\_\_\_\_  
 Invoice # \_\_\_\_\_  
 Dealer's name \_\_\_\_\_  
 Dealer's Add \_\_\_\_\_  
 Dealer's telephone# \_\_\_\_\_

**QC Report info**

Model #	
Inspector	
Date	

P/N : 16-4BA10061F

物料编号 : 16-4BA10061F

名称 : MA10-英文说明书

规格 : 70\*108mm 共6P , 70g书纸 单色印刷 , 风琴折

日期 : 2020年5月9日

This device complies with part 15 of the FCC Rules. Operation is subject to the following two conditions: (1) this device may not cause harmful interference, and

(2) This device must accept any interference received, including interference that may cause undesired operation.

Changes or modifications not expressly approved by the party responsible for compliance could void the user's authority to operate the equipment. This equipment has been tested and found to comply with the limits for a Class B digital device, pursuant to Part 15 of the FCC Rules. These limits are designed to provide reasonable protection against harmful interference in a residential installation. This equipment generates uses and can radiate radio frequency energy and, if not installed and used in accordance with the instructions, may cause harmful interference to radio communications. However, there is no guarantee that interference will not occur in a particular installation. If this equipment does cause harmful interference to radio or television reception, which can be determined by turning the equipment off and on, the user is encouraged to try to correct the interference by one or more of the following measures:

- - Reorient or relocate the receiving antenna.
- - Increase the separation between the equipment and receiver.
- - Connect the equipment into an outlet on a circuit different from that to which the receiver is connected.
- - Consult the dealer or an experienced radio/TV technician for help.

The device has been evaluated to meet general RF exposure requirement.